

Life Science Journal

Life Science Journal

Marsland Press

PO Box 180432, Richmond Hill, New York 11418, USA

Website:
<http://www.sciencepub.net>

Emails:
editor@sciencepub.net
sciencepub@gmail.com

Phone: (347) 321-7172

Life Science Journal 2012 Volume 9, Number 4, Part 17 ISSN:1097-8135



Volume 9, Number 4, Part 17 December 25, 2012 ISSN:1097-8135

Life Science Journal



 **MARSLAND PRESS**
Multidisciplinary Academic Journal Publisher

Websites:
<http://www.lifesciencesite.com>
<http://www.sciencepub.net>

Emails:
lifesciencej@gmail.com
editor@sciencepub.net

Life Science Journal

Acta Zhengzhou University Oversea Version
(Life Sci J)

Life Science Journal, the Acta Zhengzhou University Oversea Version, is an international journal with the purpose to enhance our natural and scientific knowledge dissemination in the world under the free publication principle. The journal is calling for papers from all who are associated with Zhengzhou University-home and abroad. Any valuable papers or reports that are related to life science - in their broadest sense - are welcome. Other academic articles that are less relevant but are of high quality will also be considered and published. Papers submitted could be reviews, objective descriptions, research reports, opinions/debates, news, letters, and other types of writings. Let's work together to disseminate our research results and our opinions.

Editor-in-Chief: Shen, Changyu, Ph.D., Professor, Chinese Academy of Sciences

Associate Editors-in-Chief: Ma, Hongbao; Cherng, Shen; Xin, Shijun

Editorial Boards: Aghdam, Hashemi; An, Xiuli; Chandra, Avinash; Chen, George; Dong, Ziming; Duan, Guangcai; Edmondson, Jingjing; Gao, Danying; Huang, Shuan-Yu; Li, Xinhua; Li, Yuhua; Lindley, Mark; Liu, Hua; Liu, Hongmin; Ma, Margret; Qi, Yuanming; Sabyasachi Chatterjee; Shang, Fude; Shi, Lifeng; Song, Chunpeng; Sun, Yingpu; Wang, Lidong; Wen, Jianguo; Xu, Cunshuan; Xu, Yuming; Xue, Changgui; Zaki, Mona; Zhang, Jianying; Zhang, Kehao; Zhang, Shengjun; Zhang, Xueguo; Zhang, Zhan; Zhang, Zhao; Zhu, Huaijie

Introductions to Authors

1. General Information

- (1) **Goals:** As an international journal published both in print and on internet, **Life Science Journal** is dedicated to the dissemination of fundamental knowledge in all areas of nature and science. The main purpose of **Life Science Journal** is to enhance our knowledge spreading in the world under the free publication principle. It publishes full-length papers (original contributions), reviews, rapid communications, and any debates and opinions in all the fields of nature and science.
- (2) **What to Do:** The **Life Science Journal** provides a place for discussion of scientific news, research, theory, philosophy, profession and technology - that will drive scientific progress. Research reports and regular manuscripts that contain new and significant information of general interest are welcome.
- (3) **Who:** All people are welcome to submit manuscripts in life science fields. Papers of other fields are also considered.
- (4) **Copyright and Responsibility of Authors to their Articles:** When the manuscript(s) is submitted to the journal, the authors agree the following: All the authors have participated sufficiently in this work; The article is not published elsewhere; Authors are responsibility on the contents of the article; The journal and author(s) have same right for the copyright of the article and either of the journal or author(s) can use it by anyway without noting the other party.
- (5) **Publication Costs:** US\$500 per article to defray costs of the publication will be paid by the authors when it is received. Extra expense for color reproduction of figures will be paid by authors (estimate of cost will be provided by the publisher for the author's approval).
- (6) **Advertisements:** The price will be calculated as US\$400/page, i.e. US\$200/a half page, US\$100/a quarter page, etc. Any size of the advertisement is welcome.

2. Manuscript Preparation

Each manuscript is suggested to include the following components but authors can do their own ways:

- (1) **Title:** including the complete article title; each author's full name; institution(s) with which each author is affiliated,

with city, state/province, zip code, and country; and the name, complete mailing address, telephone number, facsimile number (if available), and at least one email address for author(s). (2) **Abstract:** including Background, Materials and Methods, Results, and Discussions. (3) **Key Words.** (4) **Introduction.** (5) **Materials and Methods.** (6) **Results.** (7) **Discussions.** (8) **Acknowledgments.** (9) **References.**

3. Manuscripts Submission

- (1) **Submission Methods:** Submission through email (editor@sciencepub.net) is encouraged.
- (2) **Software:** The Microsoft Word file will be preferred.
- (3) **Font:** Normal, Times New Roman, 10 pt, single space.
- (4) **Indent:** Type 2 space in the beginning of each new paragraph.
- (5) **Manuscript:** Don't use "Footnote" or "Header and Footer".
- (6) **Email:** At least one author's email must be put under title.
- (7) **Title:** Use Title Case in the title and subtitles, e.g. "**Debt and Agency Costs**".
- (8) **Figures and Tables:** Use full word of figure and table, e.g. "**Figure 1. Annual Income of Different Groups**", **Table 1. Annual Increase of Investment**".
- (9) **References:** Cite references by "last name, year", e.g. "(Smith, 2003)". References should include all the authors' last names and initials, title, journal, year, volume, issue, and pages etc.

Reference Examples:

Journal Article: Hacker J, Hentschel U, Dobrindt U. Prokaryotic chromosomes and disease. *Science* 2003;301(34):790-3. **Book:** Berkowitz BA, Katzung BG. Basic and clinical evaluation of new drugs. In: Katzung BG, ed. Basic and clinical pharmacology. Appleton & Lance Publisher. Norwalk, Connecticut, USA. 1995:60-9.

- (10) **Submission Address:** editor@sciencepub.net, Marsland Press, PO Box 180432, Richmond Hill, New York 11418, USA, 347-321-7172.

Marsland Press / Zhengzhou University
PO Box 180432, Richmond Hill, New York 11418, USA
<http://www.lifesciencesite.com>; <http://www.sciencepub.net>
lifesciencej@gmail.com; editor@sciencepub.net
© 2005-2012 Marsland Press / Zhengzhou University

CONTENTS

364	Effect of Tailored Counseling for Patients Undergoing Hemodialysis upon Their Self-Care Jehan S. Ali Sayyed, Lobna M. Gamal Aliand Enshrah R. Mohamed	2463-2471
365	Detection of Plasmid-Mediated 16S rRNA Methylase Conferring High-Level Resistance to Aminoglycosides in Gram negative bacilli from Egypt Aisha Abu Aitta; Manal El Said, Ehab El Dabaa; Mohamed Abd El Salam and Hesham Mohamed Mahdy	2472-2479
366	Evaluation of non-functional characteristics of web-based systems modeled and designed using aspect-oriented technology by aspectual software architecture analysis method (ASAAM) Davood Karimzadganmoghadam , Davood Vahdat , Mohammad Pira , Reza Asgarimoghadam	2480-2486
367	Sufficient condition of a subclass of analytic functions defined by Hadamard product Muhammad Arif, Irshaad Ahmed, Mohsan Raza and Khalid Khan	2487-2489
368	Prevalence and Determinants of Low Birth Weight in Abha City, Ksa Faten M. R. Ismaeil H and Al Musa H. M	2490-2495
369	The Study of the Relationship between the Place of Residence Quality and the Feeling of Social Security in Kashan Melahat Ahmadi, Batoole Abedi, Sanam Taghizadeh and Maryam Rezghi	2496-2501
370	The consideration of nerve pressures arising from work and its role in reducing the organization productivity in Fars province Red Crescent Society Mehrza Sarfarazi, Sholeh-Sadat Ehteshami	2502-2510
371	The effect of government size on inflation in Iran Marzieh Esfandiari , Vahid Dehbashi , Hamid Mohammadi , Iman Shahraki	2511-2515
372	Screening Of Antimicrobial Activity Of Sesquiterpenoid Crude Extract Of <i>Ganoderma</i> Asghar.Sharifi, Seyed Sajjad Khoramrooz, Soheyla JahediSeyed Abdolmajid Khosravani	2516-2519
373	Factors Influencing Households' Environmental Hazard Exposure in Ibadan Metropolis Abayomi Samuel Oyekale	2520-2527
374	Linearization Algorithms for a Level and PH Process Subbulekshmi, Kanakaraj	2528-2533
375	Depressive disorder among brucellosis patients in Hamadan, Iran: A case-control study Peyman Eini MD, Mohammad Mehdi Majzooobi MD, Mohammad Ahmadpanah, Mojgan Mamani MD	2534-2537
376	Biochemical and pathological study of protective effect of Vitamin A in Azathioprine - induced pancreas toxicity in Rat Rasoul Estakhri, Ali Khodadadi, Mahsa Parnian, Babak Hajipour, Mehdi Kamalipour, Maryam Mohsenikia, Ehsan Jangholi, Fereydoon Abedi	2538-2542
377	Anew Shoe Decreases Pain and Fatigue in Ascending and Descending the stairs in patients with knee osteoarthritis Amir Mohammad Navali, Bina Eftekhari Sadat, Babak Hajipour. Reza Ranjbaran	2543-2549
378	Double-blind comparison of intra pleural analgesia through a catheter and intra pleural	2550-2555

- analgesia through a catheter beside a chest tube**
Touraj Asvadi Kermani, Mehdi Zamiri , Saviz Pazhhan, Shahin Mir Mohammad Sadeghi, Babak Hajipour, Hamze majidi
- 379 Comparison Of Direct Visual Inspection (DVI) With Pap Smear In Diagnosis Of Precancerous Lesion Of Cervix** 2556-2560
Fatemeh Mallah, Fatemeh Nazari, Nazli Navali, Babak Hajipour.
- 380 Heterologous reconstitution the polyunsaturated fatty acid biosynthetic pathway of *Phaeodactylum tricornutum* in *Arabidopsis thaliana*** 2561-2565
Yun-tao Li , Yuan-min Zhu, Chun-hua Fu, Mao-teng Li, Long-jiang Yu
- 381 Detection of *cambylobacter* spp. in stool samples by new methods in comparison to culture** 2566-2571
Mona Z Zaghloul, Naglaa Farouk and Zeinab Ali Galal
- 382 Virulence of two Entomopathogenic nematodes (*Heterorhabditis bacteriophora*, *Heterorhabditis zealandica*) to *Galleria mellonella* (Lepidoptera: Pyralidae), *Tenebrio Molitor* (Coleoptera: Tenebrionidae) and pupae in the laboratory** 2572-2579
Lubanza Ngoma, Mirabel Akwa Nyamboli , Vince Gray, Olubukola Oluranti Babalola
- 383 Secured disclosure of data in multiparty clustering** 2580-2585
G. Kirubhakar , Dr. C. Venkatesh
- 384 Identifying and Prioritization Effective Factors in TQM implementation Using AHP and DEMATEL Methods** 2586-2592
Reza Kiani mavi, Shahram madanshekaf, Kiamars Fathi Hafshejani, Davood Gharakhani
- 385 Mechanism of injury mechanism of boys' amateur epical athletes in Kyokushin ka, Karate and Aikido** 2593-2597
Dr. Mohsen Ghofrani, Seyyed Hamed Mousavi
- 386 A Study of the Relationship between Free Cash Flow and Debt** 2598-2603
Peyman Imanzadeh, Rademan Malihi Shoja, Akbar Poursaleh
- 387 Relationship between organizational structure and knowledge management among staff managers of physical education organization** 2604-2609
Mahmud Gudarzi, Mojtaba Abutorabi, Mohsen Ghofrani
- 388 Studying the effect of 8 weeks corrective exercise program on student's scoliosis changes.** 2610-2612
Farhad Kouhi Achachlouei, Mehdi Abbaszadegan, Sakene Aminjad, Mohammad Nasiri
- 389 The Effect of Coach Stability on the Performance of Football Teams in Iran Pro League** 2613-2616
Farideh Hadavi , Mohammad Soltani, Lila Sabbaghian Rad Khalil Alavi

Effect of Tailored Counseling for Patients Undergoing Hemodialysis upon Their Self-Care

Jehan S. Ali Sayyed, Lobna M. Gamal Ali and Enshrah R. Mohamed

Medical Surgical Nursing Department, Faculty of Nursing El-Minia University
lobnahassn@yahoo.com

Abstract: End-stage renal disease (ESRD) is considered as a public health problem. The incidence and prevalence are reportedly increasing all over the world. Kidney failure is considered as a medical, social and economic problem to patients and their family. The present study **aimed** to evaluate the effect of counseling program on patient's self-care. The research **hypothesis**; counseling will affect positively on self-care for patients with hemodialysis. **Methods:** The study was conducted at the artificial kidney unit of Minia University Hospital. The sample of this study comprised 80 adult patients including both sex, their age ranged from 20-55 years old, They were selected by convenience randomly assigned two equal groups control (group1) and interventional group (group2) (40 in each). **Three tools** were used to collect the data in this study, tool one: Interview questionnaire were included biosocial demographic data and knowledge assessment sheet. Tool two: Patients practices checklist. Tools three: Counseling program according to patient's needs. **Results** The results revealed that there were highly statistically significant differences for patients under study in relation to patient's level of knowledge, performance skill and self-care between pre and post counseling program. In **conclusion**; the counseling program implementation improved patients' knowledge, skill performance and self-care. Counseling program should be available in a form of illustrated booklet in hospitals as a reference for patients and reapplication of this study on larger probability sample are **recommended**.

[Jehan S. Ali Sayyed, Lobna M. Gamal Ali and Enshrah R. Mohamed. **Effect of Tailored Counseling for Patients Undergoing Hemodialysis Upon Their Self-Care.** *Life Sci J* 2012;9(4):2463-2471]. (ISSN: 1097-8135). <http://www.lifesciencesite.com>. 364

Keywords: Kidney failure, Patient's self care, Hemodialysis

1. Introduction

Renal failure (RF) defined as kidney fails to perform the normal excretion of metabolic wastes namely (urea, creatinine, uric acid etc.) with resultant retention of their products in the blood and fluids. Consequently, abnormalities occur in every body system and threaten the individual's life. ⁽¹⁾ End-stage renal disease is the loss of renal function requiring treatment with any form of chronic dialysis or transplantation, while incidence of renal failure is increasing. ⁽²⁾

World-Health Organization (WHO), reported that, incidence of end-stage across Europe rose from 79 to 117 patients per million populations per year. And there are more than 500,000 dialysis and renal transplant recipients in the United States in 2005 and more than 100,000 patients were newly diagnosed ⁽³⁾.

While Egypt, the estimated prevalence is 300 patients per million populations and the incidence of chronic renal failure was increased in last years in many parts of Egypt as in Daquahlia, Aswan, Assiute and El-Minia ⁽⁴⁾.

While the incidence of kidney failure patients from October 2000 to November 2004 who was admitted at artificial kidney dialysis unit in El Minia University hospital are 3175 patients, and the number of chronic hemodialysis patients was 658 during one year 2009⁽⁵⁾.

Dialysis to the layperson is at first frightening, seemingly dangerous procedure. Once the procedure has been initiated these patients find themselves facing the prospect of two or three dialysis sessions a week for approximately six hours per session on the machine at the rest of their lives. In addition, they have a subject to strict adherence of dietary and fluid restrictions as well as an intense daily regimen of medication and the curtailing of certain physical activities ⁽⁶⁾.

Rehabilitation for end stage renal disease patients has changed significantly over the last 40 years. Initially, the concept focused on return to employment. Today renal rehabilitation is defined broadly, in terms of optimal functioning for individual patients and restoration to productive activities-not simply employment to faster renal rehabilitation and guide program development ⁽⁷⁾.

The Life Options Rehabilitation Advisory Council (LORAC) identified five core principles called the "5Es". Encouragement, Education, Exercise, Employment and Evaluation. Considerable progress has been made in measuring outcomes of care and in establishing a connection between rehabilitation interventions and improved outcomes ⁽⁸⁾.

The professional nurse is playing a vital role for improving the physical and psychological condition.

She can also support the family by letting them know the negative feelings of distress and helps to provide verbal and written instructions and to inform them of resources that are available for assistance and support (9),(10).

Aim of study

To evaluate the effect of counseling program on patient's self-care.

Subjects and Method

Setting:

The study was conducted at artificial kidney Unit of Minia University Hospital.

Subjects:

The sample of this study comprised 80 adult patients including both sexes, their age ranged from 20-55 years old, with chronic renal failure and undergoing hemodialysis, they were assigned two equal groups control(group1) and interventional group(group2) (40 in each).

Research Design:

A Quazi experimental research design will be utilized to fulfill the aim of the study.

Research Hypothesis

Counseling will affect positively on self-care for patients with end stage renal disease (ESRD).

Tools:

Three tools were used to collect the data for this study

First Tool:

An Interview Questionnaire Sheet, it included two parts

1st part covering biosocial and demographic data of the patient as age, sex, level of education, marital status, occupation.

2nd part included Pre/Post knowledge assessment sheet covering the following items: renal failure disease, its signs, symptoms, complication and treatment, also contains patient's knowledge about diet, fluid intake, exercise, diagnostic test and measures to minimize the complication.

Second Tool:

This tool was used pre counseling ,immediately after application of the counseling ,and after three months latter to assess the patient's attitude toward self care related to hemodialysis complications, this tool was consists of nine sections :follow up diet regimen ,fluid intake, perform exercises, skin care, fistula care, medication regimen and avoidance and management of complication.

Third Tool:

Involve counseling program according to patient's needs.

Methods

Permission to conduct the study was obtained from the responsible authorities of dialysis unit after explanation of the aim of the study.

Development of the tools after reviewing the related literature was done

The tools were reviewed by a jury for clarity, feasibility, applicability, and the content validity of the tools and all the necessary modifications were done, the Jury members were three experts. professional medical-surgical nursing and nephrology and appropriate modification was done.

A pilot study was conducted on a number of 10% from patient's size to test the clarity and feasibility of assessment sheet and tools accordingly, the necessary modifications were done.

Data pertinent to the study will be collected through interview and a direct observation will be utilized for data collection.

Limitations of the study:

Some patients refused to participate in the study and others refused to continue follow-up.

Procedure:

The volunteers read a detailed description of the protocol and provided a written informed consent was obtained from each participating patients to be included in study clarification of the nature and purpose of the study was done on initial interview with each patients. The investigator emphasized that the participant is voluntary and confidentially .All patients undergoing clinical evaluation and investigation in order to facilitate implementation of the tools, the following aid were designed:

A manual booklet in simple language to every patient for study group was to complement and aid, teaching the manual which was developed by the researcher .Pictures illustrating the importance points were visible for illiterate patients.

The Contents of the Booklet (Teaching Model):

The booklet was designed to meet patients' needs and his or her interest according to their levels of understanding. It included the following: providing knowledge related to renal failure disease, also information and instructions related to diet and fluid need, vascular access, its care and certain precautions, and type of exercise for dialysis patient, its benefits and precautions. Lastly the booklet contains instructions related to patient's practices on his health condition and encourage patient to change his behavior from negative behavior to positive behavior.

The contents of the teaching model were given on three sessions, which were conducted on three meetings every meeting was carried out on the same day of the patients dialysis session and the time spent in these sessions with each patient ranged between 45 – 60 minutes.

The Three Sessions Were:

The First Session:

Included information about the anatomy and physiology of the kidney, meaning of renal failure, its symptoms and management, also provided information about therapeutic diet, practice of measuring body weight, fluid intake per day, and how to measure the daily intake and output.

The Second Session: Provided information related to problems of chronic dialysis and management for each problem, also contains demonstrations related to management of skin care, care for the vascular access, common problems of the access and how to deal with these problems.

The Third and Last Session: Provided information about exercise and daily activity that can help the chronic renal failure patient to solve his or her problems through exercise.

Evaluation of Group:

The researcher assess patient's practices before application of the counseling, the second evaluation immediately after application of counseling, and last evaluation three months (follow-up tests) after application of the counseling, the researcher was used patient's practices checklist.

Statistical Analysis:

The collected data were coded, analyzed using Statistical Package for Social Sciences (SPSS) software, and tabulated.

- Descriptive statistics: number and percent, mean and standard deviation were used.
- Statistical comparison between both groups was performed with paired t-test, unpaired t-test.
- Test was considered significant when P value (< 0.05).

3. Results

Table (1): Shows the socio-demographic characteristics of the studied groups (control group and study group) .It was found that the majority of sample in experimental & control group were male, married& worker with a percentage of 62.5%,75%87.5%,75%,87.5%,75% respectively. However, majority of the study and control group subjects 62.5% were in the age ranged of 40-55years. No statistically significant difference was found.

Figure (1) illustrated that; diabetes mellitus and hypertension constituted 50 % of the experimental group 37.5% of the control group

Figure (2) Illustrated that 50 % of the experimental group had between 4-7 years while 25% of the same group had 1-3 years. As regard the control group, it was found out that 37.5% 4-7 years had constituted 37.5%.

I not understand what you mean Table (2): Illustrated that there was a significant statistical differences in patient's knowledge in area of meaning of renal failure ,signs and symptoms of chronic renal failre ,routine diagnostic test ,type of diet, type of

fluid intake ,medication ,and complication related to disease and hemodialysis between control and experimental group after teaching program.

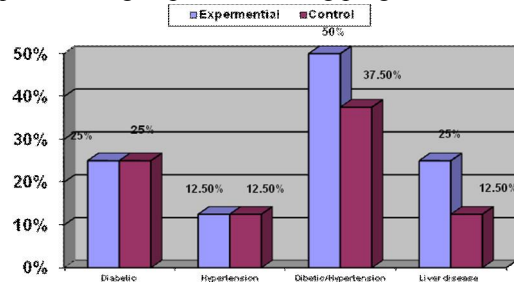

Figure (1):Distribution of Patients According to Associated Disease

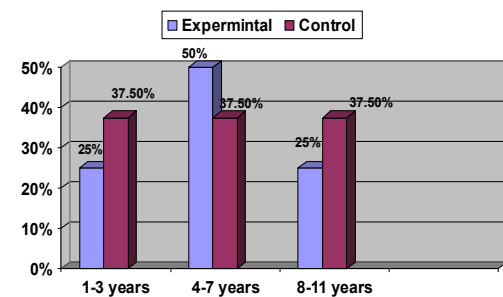

Figure (2):Distribution of Patients According to Years of Renal Disease

The highest mean score as regard the control group(10.350) for diet while the lowest mean score as regard control group(3.475) routine diagnostic test . As regard experimental group the highest mean score as regard complication it was (55.22) while the lowest mean score as regard medication, it was(31.750).

Table (3): This table illustrated that: Improvement of mean score in patients practices in area of diet regimen, measure fluid intake and output, done exercises, skin care, fistula care, medication regimen, activity of daily living, measuring of daily body weight and management of complication post program and in follow-up.

Also this table illustrated that; there were statistical significance differences between mean score of patients practices in preprogram, and follow-up tests in area of diet, fluid intake, skin care, medication, fistula care, sexual activities and blood pressure during hemodialysis session. Also; there were statistical significance differences between mean score of patients practices preprogram and post program tests in area of fistula care and blood pressure during hemodialysis session.

P₁= Comparison between Pre-test and Post-test.

P₂= Comparison between Pre-test and Follow-up test

Table (1) Distribution of Patients According to Socio Demographic Characteristics

Character	Experimental group		Control group	
	No	%	No	%
Sex				
Female	15	37.3%	10	25%
Male	25	62.5%	30	75%
Age				
20 < 30	5	12.5%	10	25%
30 < 40	10	25%	5	12.5%
40 – 55	25	62.5%	25	62.5%
Education				
Illiterate	15	37.5%	10	25%
Read & Write	5	12.5%	10	25%
Primary	5	12.5%	5	12.5%
Secondary	5	12.5%	5	12.5%
High	10	25%	10	25%
Occupation				
Worker	35	87.5%	30	75%
Not work	5	12.5%	10	25%
Marital Status				
Married	35	87.5%	30	75%
Single	5	12.5%	10	25%

Table (2) Paired Sample Statistics of the Patients Knowledge Mean Scores for Control and Experimental Group After Teaching Program.

Area of Knowledge		X	Sd	Sig
Meaning of RF	Control	4.025	2.081	0.000*
	Experimental	41.325	13.761	
Signs & symptoms of RF	Control	4.125	1.870	0.000*
	Experimental	38.100	11.354	
Routine Diagnostic Test	Control	3.475	1.694	0.000*
	Experimental	44.750	10.033	
Type of Diet	Control	10.350	4.515	0.001*
	Experimental	49.532	8.941	
Type of Fluid Intake	Control	9.700	4.231	0.000*
	Experimental	45.150	14.571	
Medication	Control	4.175	2.396	0.020*
	Experimental	31.750	12.315	
Exercise	Control	9.600	3.524	0.000*
	Experimental	35.025	15.443	
Complications	Control	3.550	1.754	0.030*
	Experimental	55.22	3.724	

Table (3): Comparison Between Patients' Practices Mean Scores in Pre, Post and Follow-up Tests for the Study Group

Variables	Pre-test (n= 40)	Post-test (n= 40)	Follow-up test (n= 40)	P1	P2
Diet Regimen:				0.189	0.000*
Mean ± SD	33.0 ± 33.9	48.0 ± 27.8	87.0 ± 22.7		
Range	0.0 – 100.0	0.0 – 100.0	20.0 – 100.0		
Measure Fluid Intake& out put:				0.061	0.001*
Mean ± SD	44.4 ± 38.8	68.0 ± 20.9	90.6 ± 12.1		
Range	5.6 – 100.0	38.9 – 100.0	66.7 – 100.0		

Exercises:					
Mean \pm SD	66.7 \pm 27.6	68.6 \pm 21.6	72.8 \pm 17.5	0.693	0.431
Range	0.0 – 100.0	22.2 – 100.0	33.3 – 100.0		
Skin Care:					
Mean \pm SD	73.8 \pm 41.1	85.0 \pm 24.2	100.0 \pm 0.0	0.258	0.014*
Range	12.5 – 100.0	37.5 – 100.0	100.0 – 100.0		
Fistula Care					
Mean \pm SD	39.7 \pm 14.9	68.4 \pm 11.7	85.9 \pm 6.4	0.000	0.000*
Range	188 – 68.8	50.0–93.8	75.0–93.8		
Medication Regimen					
Mean \pm SD	76.5 \pm 20.8	79.2 \pm 16.5	98.6 \pm 4.4	0.618	0.001*
Range	36.4 – 100.0	54.6 – 100.0	85.7 – 100.0		
Activities of Daily Living:					
Mean \pm SD	82.2 \pm 22.3	83.3 \pm 22.9	92.8 \pm 16.6	0.924	0.074
Range	33.3 – 100.0	33.3 – 100.0	44.4 – 100.0		
Measuring of Body Weight					
Mean \pm SD	66.7 \pm 14.6	70.2 \pm 16.2	79.2 \pm 11.2	0.088	0.017*
Range	41.7 - 91.7	41.7 - 91.7	50.0 – 91.7		
Management of Complication:					
Mean \pm SD	28.9 \pm 12.3	61.1 \pm 12.8	84.4 \pm 12.9	0.001	0.000*
Range	20.0 – 60.0	40.0 – 80.0	60.0 – 100.0		

Table (4): Comparison Between Patients' Practices Mean Scores in Pre, Post and Follow-up Tests for the Control

Variables	Pre-test (n= 40)	Post-test (n= 40)	Follow-up test (n= 40)	P1	P2
Diet Regimen:					
Mean \pm SD	24.0 \pm 22.1	22.0 \pm 20.4	22.0 \pm 20.4	0.527	0.729
Range	0.0 – 80.0	0.0 – 60.0	0.0 – 60.0		
Measure Fluid Intake & Out Put:					
Mean \pm SD	28.7 \pm 28.1	28.5 \pm 28.5	25.5 \pm 28.9	1.000	0.586
Range	0.0 – 100.0	0.0 – 100.0	0.0 – 100.0		
Exercises:					
Mean \pm SD	45.8 \pm 27.3	45.0 \pm 26.9	43.1 \pm 24.8	0.317	0.679
Range	0.0 – 83.3	0.0 – 83.3	0.0 – 83.3		
Skin Care:					
Mean \pm SD	71.3 \pm 40.6	70.6 \pm 41.2	71.3 \pm 40.4	0.317	0.786
Range	12.5 – 100.0	12.5 – 100.0	12.5 – 100.0		
Fistula Care					
Mean \pm SD	35.0 \pm 15.4	36.6 \pm 14.7	34.0 \pm 10.4	0.096	1.000
Range	6.3 – 75.0	6.3 – 75.0	6.3 – 56.3		
Medication Regimen					
Mean \pm SD	71.5 \pm 21.8	70.6 \pm 23.1	65.5 \pm 21.8	0.317	0.458
Range	36.4 – 100.0	27.3 – 100.0	36.4 – 100.0		
Activities of Daily Living:					
Mean \pm SD	65.0 \pm 32.1	63.9 \pm 30.3	65.0 \pm 30.2	0.480	0.827
Range	11.1 – 100.0	22.2 – 100.0	22.2 – 100.0		
Measuring of Body Weight					
Mean \pm SD	46.9 \pm 27.2	45.8 \pm 27.0	42.7 \pm 21.1	0.317	0.683
Range	0.0 – 100.0	0.0 – 91.7	0.0 – 83.3		
Management of Complication:					
Mean \pm SD	23.5 \pm 12.7	24.7 \pm 13.3	28.2 \pm 12.4	0.317	0.408
Range	0.0– 60.0	0.0– 60.0	20.0– 60.0		

Table (5): Relationship Between Patients' Practices and Years of Disease

Variables	Years of Disease			P-value
	1<4	4<8	8 -11	
Diet regimen:				0.636
Mean ± SD	31.5 ± 30.6	25.0 ± 20.7	20.0 ± 31.0	
Range	0.0 – 100.0	0.0 – 60.0	0.0 – 80.0	
Measure Fluid Intake& Out Put:				0.963
Mean ± SD	37.7 ± 36.5	34.1 ± 29.7	34.9 ± 35.7	
Range	5.6 – 100.0	11.1 – 100.0	0.0 – 100.0	
Exercises:				0.532
Mean ± SD	57.1 ± 27.4	47.2 ± 39.1	64.8 ± 22.4	
Range	0.0 – 100.0	0.0 – 83.3	22.2 – 83.3	
Skin Care:				0.502
Mean ± SD	77.4 ± 28.2	68.8 ± 43.3	56.3 ± 47.9	
Range	12.5 – 100.0	12.5 – 100.0	12.5 – 100.0	
Fistula Care				0.256
Mean ± SD	18.8 ± 75.0	30.5 ± 14.3	34.4 ± 18.0	
Range	36.4 – 100.0	6.3 – 43.8	18.8 – 62.5	
Medication Regimen				0.214
Mean ± SD	77.5 ± 19.6	72.7 ± 21.2	60.6 ± 26.1	
Range	36.4 – 100.0	45.5 – 100.0	36.4 – 100.0	
Activities of Daily Living:				0.956
Mean ± SD	74.4 ± 27.7	73.6 ± 34.1	70.4 ± 30.4	
Range	11.1 – 100.0	22.2 – 100.0	22.2 – 100.0	
Measuring of Body Weight				0.806
Mean ± SD	58.3 ± 26.2	53.3 ± 24.0	51.4 ± 19.3	
Range	0.0 – 100.0	25.0 – 83.3	33.3 – 83.3	
Management of Complication:				0.798
Mean ± SD	27.3 ± 11.6	25.7 ± 9.8	23.3 ± 19.7	
Range	20.0 – 60.0	20.0 – 40.0	0.0 – 60.0	

Table (6): Relationship Between Patients' Practices and Sex

Variables	Sex		P-value
	Male (n= 25)	Female (n= 15)	
Diet Regimen:			0.572
Mean ± SD	29.7 ± 30.9	22.9 ± 13.8	
Range	0.0 – 100.0	0.0 – 40.0	
Measure Fluid Intake& Out Put:			0.424
Mean ± SD	38.6 ± 36.8	27.0 ± 17.7	
Range	0.0 – 100.0	11.1 – 55.6	
Exercises:			0.098
Mean ± SD	59.8 ± 29.3	39.7 ± 23.2	
Range	0.0 – 100.0	11.1 – 83.3	
Skin Care:			0.560
Mean ± SD	74.2 ± 39.9	64.3 ± 44.7	
Range	12.5 – 100.0	12.5 – 100.0	
Fistula Care			0.758
Mean ± SD	37.7 ± 13.8	35.7 ± 21.6	

Range	18.8 – 68.8	6.3 – 75.0	
Medication Regimen			0.454
Mean ± SD	75.2 ± 21.7	68.5 ± 19.1	
Range	36.4 – 100.0	45.5 – 100.0	
Activities of Daily Living:			0.707
Mean ± SD	74.4 ± 29.7	69.8 ± 24.6	
Range	11.1 – 100.0	22.2 – 100.0	
Measuring of Body Weight			0.453
Mean ± SD	58.0 ± 23.0	50.0 ± 28.5	
Range	0.0 – 91.7	16.7 – 100.0	
Management of Complication:			0.937
Mean ± SD	26.2 ± 12.1	26.7 ± 16.3	
Range	0.0 – 60.0	20.0 – 60.0	

Table (4): show that: there is no any improvement in mean score of patients practices mean scores in preprogram, post program and follow-up tests in the control groups. Also there are no any statistical significance differences between pre program, post program and follow-up tests of patients practices mean scores in any item of patients practices.

Table (5): This table shows that: The mean score of patients practices was decrease with increase years of disease. There is no statistical significance differences between mean score of patients practice in different period of disease.

Table (6): This table shows that: The mean score of patients practices in male group was increase more than mean score of patients in female group. There is no statistical significance difference between mean score of patients practice in male and female group.

4. Discussion

In the present study, the total studied subjects were 40 patients and 40 controls. The majority of the sample size in the study group was males and the minority of the sample size in the same group was female, there finding was supported by Shams El-Deen, 2000⁽²⁾. Males still having a higher risk than females in developing renal failure.

In the present study The main age of the studied patient was 20-55 years the highest affection was observed in the age 40 – 55 while the Shams El-Deen, 2000⁽²⁾ was observed that highest affection in the middle age group(35) years, and the lowest affection was observed in the older age group (65)years.

Ezzat et al., (2008)⁽¹¹⁾ found also that in Alexandria the males were 63% and females were 37% for renal disease. In Qena the least affected group was 60 years old and above and the majority were males in the age group 20 – 40 years.

As regard the occupation of the patients in this study it was found that the majority of patients size in

the experimental group were worker, and the minority of the patients in the same group were not worker. This finding was supported by Ahamed., 2007⁽¹²⁾. The incidence of end-stage renal disease was high in workers' patients than not workers. While the Ezzat et al.,(2008)⁽¹¹⁾ found that workers' patient were 39% and no functioning including housewife constituted 46%.

As regard the marital status in this study, the majority of the patients size in the study group was married. The incidence of end-stage renal disease was observed high in married patients than single patients. this results may be related increase age of married patients and the married patients were old age. The same results were found in Esmailia (80% vs. 20%) and El-sharkyea (83.3% vs. 16.7%) respectively⁽³⁰⁾. Mohmoud. (2006),⁽¹⁰⁾ found a similar results that (16.9%) were single and (83.1%) were married.

Ahamed. (2007)⁽¹²⁾ Found that the majority of the studied patients (74%) were married and only (26%) were singled.

Regarding associated disease in the present study was found that diabetes mellitus and hypertension constituted half of the experimental group and more than one third of the control group.

This finding was supported by the finding of Mortons &Fontine., (2009)⁽¹³⁾ where they found that diabetes mellitus was found to be significantly higher in cases of end-stage renal disease than in the control group (12.5% vs 5.8%), where in the same study the percent of hypertension patients with end-stage renal disease is significantly higher than that for controls (32.2% vs 16.7%).

Another studies carried out in Egypt by Ezzat et al.,(2008)⁽¹¹⁾ where they found that diabetes mellitus as a risk factor was present only in Qena in upper Egypt and 8% in Alexandria, 11% in Esmailia and 6% in El-Sharkyea, in the some study were found that hypertension was high in cases of end-stage renal disease in same places.

In the USA States Renal Data System. (2009) ⁽¹⁴⁾. reported that diabetic nephropathy continues to be the most common cause for end-stage renal disease. accounting for 35.7% of cases in the same study was reported that hypertension was the 2nd most common cause for end-stage renal disease and increasing by 9.1% per year

Blake & Meara., (2004) ⁽¹⁵⁾. reported that the traditional goals of rehabilitation have been prevention of physical deformity, maintenance of physical function, restoration of function, client and family education and reintegration of the client into his or her family and society

Oberley & Sadler., (2006) ⁽⁸⁾. defined renal rehabilitation in terms of optimal functioning for individual patients and restoration to productive activities-not simply employment, to faster renal rehabilitation and guide program development, the life options rehabilitation advisory council identified five core principles called the "5E_s". Encouragement, education, exercise, employment and evaluation.

In related to encouragement at this study there was statically significant difference between study and control group, where study group patient were more knowledgeable in the following items (Meaning of renal failure, signs and symptoms ,routine diagnostic test, diet, fluid intake, exercise, medication, Exercises).

Also as regard encouragement related to improved the patient's attitude toward his self care in this study the researcher help patient to educate about his diet and fluid intake through learn them about daily requirements of every one of diet elements, daily amount of fluid intake, and how solving problems resulting from chronic hemodialysis.

Also the present study show that statistical significant difference between patient's practices in preprogram, and follow-up tests in area of diet, fluid intake, skin care, medication care, fistula care, daily weight, measuring to minimize complications.

Tawney. (2005) ⁽¹⁶⁾. found that connecting patients to rehabilitation resources early encouraging employed patients to continue working. As regard counseling, in this stage the researcher help the patients to understanding his disease and its treatment. Counseling was the key of this understanding. The present study's results reported that their were a significant improvement in patient's knowledge in study group after application of the counseling.

As regard diet in the present study, the researcher provided information about nutrition e.g. types of foods and amount of each type for renal failure patient. the present study reported an significant statistical differences in patient's knowledge and patient's practices in area of diet

between preprogram and post program in study group.

Atteya., (2007) ⁽¹⁾.found that eating holds every personal meaning for all of us it is generally considered a pleasurable and satisfying experience. eating provides a means of relieving anxiety. Dialysis patients experience these same kinds of needs However, the dialysis patient must follow certain rigid dietary restrictions and this presents a source of frustration to him.

As regard exercise in counseling, the researcher encourage dialysis patients to perform exercise and educate the patients about types and duration of exercise which can be performed. At this study found that statistical significant differences between patient's knowledge preprogram and post program in study group, there was statistical significance differences between patient's knowledge in study and control group after teaching program but this results don't reflect on patient's practices, so there is no statistical significance differences between patient's practices in preprogram, post program and follow-up tests. This result may be related to good patient's capability to educate and change of his behavior but there was another factors prevent patient to do exercise as muscle deformities, physiological problems related to bone complication and cardiac disease associated with renal failure disease.

In agreement of the present study's results Walid et al., (2008) ⁽¹⁷⁾.found that physiological problems associated with renal failure disease can minimize with daily exercises.

Conclusion

Based on the results of the present study, the following had been concluded:

There were statistically significant difference in patients knowledge between study and control group and their was an improvement in patients knowledge in post program more than pre program in study group & there was statistical significant differences between pre, post program, and follow up test as regard patients practices

Recommendations

- Increase the number of qualified nurses in the artificial kidney unit.
- Make training programs for nurses about information and recent research that specializes in the care of the nursing even improve the level of knowledge and skill nurses.
- Provision professional nurse with a high scientific level to Continuous educate, guidance and training new nurses.

- Provide educational booklet for patients about chronic kidney failure, treatment and its side effects and problems and how to deal with it.
- Educate the patient's friends and family and get them to show up with the patient and his support in the crisis of his illness.
- Awareness and education community regarding the group of individuals who face the risk of exposure to chronic renal failure and cofactors on disease incidence, causes, signs and how to prevent

Corresponding authors

Lobna M. Gamal Ali

Medical Surgical Nursing Department, Faculty of Nursing El-Minia University

lobnahassn@yahoo.com

References:

1. Atteya A. (2007), Physiological and psychosocial factors affecting patient undergoing hemodialysis; submitted for partial fulfillment of Master degree in medical surgical nursing faculty of Nursing Alexandria University.
2. Shams El-Deen R., (2000)., Risk factors and economic burden of End stage renal disease, submitted for partial fulfillment doctoral degree in public health, Faculty of Medicine, Assiut
3. World-Health Organization(WHO), December 2009.
4. Kaliva M, (2009) General Assembly to combat kidney failure.
5. Access office in El- Minia University hospital (2009) .
6. Cobhoun H.,and Bemetliph O., (2001), Risk factors for renal disease, service of the U.S. National library of medicine and the National Institutes of health, sop; 44 supp 12; 546-53.
7. Sousa A. 2008 Psychiatric issue in renal failure and dialysis, Indian Journal of Nephrology, volume 18, Issue: 2, page 47-50.
8. Oberley E. and Sadler J., (2006), Renal rehabilitation obstacles, progress and prospects for the future, Am J. Kidney Dis, Apr; 35 (45 app 1): S.141 – 7.
9. Levy J., Morgan J., and Brown E., (2004), A practical guide dialysis and how to manage End-stage renal failure, oxford, Hand book of dialysis, 2nd edition.
10. Mohmoud E. (2006), Arandomized study of the aetiology of chronic renal impairment in the Nephrology out-patient clinic of Assiut University hospital, Thesis submitted in partial fulfillment for the degree of M.Sc. in Medicine Page 9.
11. Ezzat E., Selem M., El-didamony M. and et al., (2008), Epidemiology of chronic renal failure in Egypt, project No. 63 final report. (unpublished).
12. Ahamed A., (2007), Psychological and physiological adaptation program of patients with chronic renal failure, submitted for partial fulfillment of doctoral degree in Medical and surgical Nursing Faculty of Nursing, Assiut University.
13. Mortons P.,and Fontine D., (2009), Renal system, critical care Nursing A holistic Approach, Eighth Edition, part 6, Page 698.
14. USA States Renal Data System (USRDS)(2008)
15. Blake C., and Meara Y., (2004), subjective and objective physical limitations in high-functioning renal dialysis patients, (NDT) Nephrology dialysis transplantation, Vol 19, No. (121): page 3124-3129.
16. Tawney K., 2005, Developing a dialysis Rehabilitation program, Nephrology Nursing journal, vol 21 ,page18-26.
17. Walid M., Donahue N., and Darmohray D., 2008, patient's care technicians, Kidney disease and transplantation, volume 20, issue 4 page 639-642.

9/2/2012

Detection of Plasmid-Mediated 16S rRNA Methylase Conferring High-Level Resistance to Aminoglycosides in Gram negative bacilli from Egypt

Aisha Abu Aitta¹; Manal El Said¹, Ehab El Dabaa²; Mohamed Abd El Salam³ and Hesham Mohamed Mahdy³

¹Microbiology Department, Theodor Bilharz Research Institute, Giza, Egypt.

²Biochemistry Department, Theodor Bilharz Research Institute, Giza, Egypt

³Medical Microbiology Department, Faculty of Science, Al-Azhar University, Cairo, Egypt
manalmicrobiology@yahoo.com

Abstract: Background: Recently, production of 16S rRNA methylases by Gram-negative bacilli has emerged as a novel mechanism for high-level resistance to aminoglycosides by these organisms in a variety of geographic locations. Therefore, the spread of high-level aminoglycoside resistance determinants has become a great concern. **Objective:** to determine the prevalence of the occurrence of 16S rRNA methylase genes in aminoglycoside-resistant gram-negative bacteria isolates. **Methods:** 30 Gram-negative bacilli amikacin resistant isolates were collected from inpatients and outpatients at Theodor Bilharz Research Institute (TBRI). Biochemical identification of bacterial species was performed with API 20E system. Antimicrobial susceptibilities of amikacin, gentamicin, tobramycin, neomycin, kanamycin, and netilmicin, were determined by the disk diffusion method and the MICs of amikacin were detected by the E test method. PCR was used to identify 16S rRNA methylase *armA* and *rmtB* genes. **Result:** *E.coli*, (15/30; 50%), *Klebsiella pneumoniae* (7/30; 23.3%), *Pseudomonas aeruginosa* (4/30; 13.3%), *Enterobacter cloacae* and *Acinetobacter baumannii* (2/30; 6.7% each) were isolated. Extended spectrum β -lactamases (ESBLs) were detected in 7 (23.6%) isolates. Among the 30 isolates, 13 (43.3%) isolates showed a high level of resistance to amikacin. Seven out of 30 (23.3%) amikacin-resistant isolates were positive for 16S rRNA methylase genes. Six isolates (20%) were positive for *rmtB* gene and one (3.3%) *Enterobacter cloacae* ESBLs producer isolate was positive for *armA* gene. *rmtB* was detected in one (3.3%) *Pseudomonas aeruginosa* isolate and five (16.7%) *E. coli* isolates, in which, 3 of them were ESBLs producers. *armA* and *rmtB* genes were not detected simultaneously. **Conclusions:** 16S rRNA methylase genes were detected in gram negative bacilli in TBRI. *rmtB* was found to be more prevalent than *armA*. There was correlation between the detection of methylase genes and the production of ESBLs.

[Aisha Abu Aitta; Manal El Said, Ehab El Dabaa; Mohamed Abd El Salam and Hesham Mohamed Mahdy. **Detection of Plasmid-Mediated 16S rRNA Methylase Conferring High-Level Resistance to Aminoglycosides in Gram negative bacilli from Egypt.** *Life Sci J* 2012;9(4):2472-2479]. (ISSN: 1097-8135). <http://www.lifesciencesite.com>. 365

Keywords: Aminoglycosides; Gram negative bacilli; *rmtB*; *armA*; PCR; ESBLs

1. Introduction

Aminoglycosides are clinically effective agents for treating a broad range of life-threatening infections caused by Gram-negative pathogens, usually in combination with β -lactam agents (Yu *et al.*, 2010). These agents bind to the A site of the 16S rRNA of prokaryotic 30S ribosomal subunits and subsequently block bacterial growth through interference with protein synthesis (Wachino *et al.*, 2006).

Over the past few decades, there have been many studies conducted regarding the mechanisms of resistance to aminoglycosides. Amikacin was developed to suppress a variety of aminoglycoside-modifying enzymes from their accessing target sites, and therefore rare, amikacin-resistant bacteria could be expected (Kang *et al.*, 2008). The emergence of pan-aminoglycoside-resistant, 16S rRNA methylase-producing, gram negative bacteria has

been increasingly reported in recent years (Yamane *et al.*, 2007).

Alteration of the 16S rRNA A site by these enzymes (designated *ArmA*, *RmtA*, *RmtB*, *RmtC*, *RmtD*, and *NpmA*) confers resistance to almost all aminoglycosides, by limiting the binding of these agents to ribosomal target sites following methylation of specific nucleotides. *armA* (Enterobacteriaceae, *Acinetobacter* spp.) and *rmtB* (Enterobacteriaceae) appear to be the most widespread and have been detected primarily in Asia and Europe (Fritche *et al.*, 2008).

During the last years, bacterial identification based on molecular methods, especially those including the sequencing of genes coding for ribosomal 16S rDNA, has become a very important tool in studying bacterial communities in samples (Head *et al.*, 1998). Nucleic acid-based detection systems including polymerase chain reaction (PCR) offer rapid and sensitive methods to detect the

presence of resistance genes and play a critical role in the elucidation of resistance mechanisms. During the last decade, they have expanded tremendously and became more accessible for clinical microbiology laboratories (Fluit *et al.*, 2001, and Ercolini, 2004).

Thus, the aim of this study was to determine the prevalence of the occurrence of 16S rRNA methylases in aminoglycoside-resistant gram-negative bacteria isolates in TBRI by using molecular detection of the 16S rRNA methylases genes.

2. Material and methods

Clinical isolates:

Between June 2010 and February 2011, 30 Gram negative amikacin resistant clinical isolates were collected from outpatient clinic, hospitalized and Intensive Care Unit (ICU) patients admitted to TBRI, Cairo, Egypt. Identification of bacterial isolates was done to the genus and species level by cultural characters and biochemical reactions using the API 20 E kit (Bio-Mérieux, France).

Antimicrobial susceptibility testing:

The antimicrobial susceptibilities of amikacin, kanamycin, gentamicin, neomycin, netilmicin and tobramycin were determined by the disk diffusion test using commercial disks (Mast Diagnostics, U.K.) according to the criteria recommended by the CLSI (CLSI, 2010) using *E. coli* ATCC 25922 as the control strain. MICs of amikacin were further determined by using E test (AB Bio Disk Solna, Sweden) method in accordance with the CLSI guidelines (CLSI, 2010). High-level resistance to amikacin was identified as MICs >256 mg/L by E test (Fritche *et al.*, 2008).

β -Lactamase characterization:

ESBL production was detected by phenotypic tests, which require a screening step followed by confirmation as recommended by the CLSI guidelines (CLSI, 2010).

A- Screening test: The disk-diffusion method for antibiotic susceptibility testing was used to screen ESBL production. Each gram negative bacilli isolate was considered a potential ESBL-producer according to the CLSI recommendation, if the zone diameter of the following antibiotics result were as follows: cefpodoxime (30 μ g) \leq 22 mm, ceftazidime (30 μ g) \leq 22 mm, aztreonam (30 μ g) \leq 27 mm and cefotaxime (30 μ g) \leq 27 mm

B-Confirmatory test (Double disk synergy test): The following antibiotics were tested: ceftazidime (FOX; 30 μ g), cefotaxime (CTX; 30 μ g), ceftazidime (CAZ; 30 μ g), cefepime (FEP; 30 μ g), aztreonam (ATM; 30 μ g), amoxicillin-clavulanic acid (AMC; 30/10 μ g), piperacillin/tazobactam (TZP; 100/10 μ g) and ampicillin (AMP; 10 μ g) (Bio-Rad, France). Antibiotic disks were arranged in proximity (30mm centre to centre) with the AMC

disk. Results of antimicrobial susceptibility were interpreted according to CLSI guidelines: FOX (S \geq 18), CTX (S \geq 23), CAZ (S \geq 18), FEP (S \geq 18), ATM (S \geq 22), AMC (S \geq 22), TZP (S \geq 21) and AMP (S \geq 17) (CLSI, 2010). Test organisms showing synergy between the AMC disk and any cephalosporin disk or the ATM disk and/or between TZP and FEP was diagnosed as ESBL-producing strains (Pitout *et al.*, 2003). The standard strain *E. coli* ATCC 25922 was used as negative control for the assay.

Detection of Methylase Genes:

The *armA* and *rmtB* genes were detected by PCR as described by Doil and Arkawa, 2007. Briefly, a fresh bacterial colony was suspended in 200 μ L of sterile distilled water and heated to 95°C for 10 min in water bath. After centrifugation at 8500 rpm for 20 min; the supernatants were removed and stored at -20°C for PCR assay. Primers for *armA* gene amplification were 5' ATTCTGCCTATCCTAATTGG 3' and 5' ACCTATACTTTATCGTCGTC 3', which are specific for the flanking regions of the gene to produce a 315 bp product. Primers for *rmtB* gene amplification were 5' GCTTTCTGCGGGCGATGTAA 3' and 5' ATGCAATGCCGCGCTCGTAT 3' which are specific for the flanking regions of the gene to produce a 173 bp product. Reactions for both genes were run on a programmable thermal controller PTC-100tm (MJ Research Inc., U. S. A) under the following conditions: initial denaturation at 95°C for 5 min, followed by 30 cycles at 95°C for 1min, at 55°C for 1min, at 72°C for 1 min, with a final extension at 72°C for 5 min and at 4°C for 10 min. PCR products were electrophoresed in 2.5% agarose gels and visualized under UV light.

Statistical Methods:

Data were statistically described in terms of frequencies (number of cases) and relative frequencies (percentages). A probability value (P value) less than 0.05 was considered statistically significant. All statistical calculations were done using computer programs Microsoft Excel 2007 (Microsoft Corporation, NY., USA), SPSS (Statistical Package for the Social Science; SPSS Inc., Chicago, IL, USA) version 15 for Microsoft Windows and Quick Calcs online calculators for scientists (Graph pad software Inc., San Diego, CA, USA)

3. Results

Specimens collected:

The study was included 30 clinical isolates of Gram negative bacilli that were collected from outpatient and inpatient of TBRI. They were 21 (70%) males and 9 females (30%). Their age was ranged from 10 to 80 years with mean age of 48.3 \pm 17.1 years. The 30 amikacin-resistant Gram negative

bacilli isolates collected from outpatient and inpatient of TBRI were *E.coli*, (15/30; 50%), *Klebsiella pneumonia* (7/30; 23.3%), *Pseudomonas aeruginosa* (4/30; 13.3%), *Enterobacter cloaca* and *Acinetobacter baumannii* (2/30; 6.7% each) (Table 1).

Antimicrobial Susceptibility Testing:

Among the 30 amikacin-resistant clinical isolates of Gram negative bacilli, all *E.coli*, *Klebsiella pneumonia*, *Pseudomonas aeruginosa* and *Enterobacter cloaca* isolates were resistant to tobramycin, gentamicin, kanamycin and netilmicin. *Acinetobacter baumannii* isolates were resistant to tobramycin and kanamycin while they were equally sensitive to gentamicin and netilmicin (50%). *E.coli*, *Klebsiella pneumonia*, *Pseudomonas aeruginosa*, *Acinetobacter baumannii* and *Enterobacter cloaca* isolates were resistant to neomycin as follows: 40%, 85.7%, 75%, 50% and 100% respectively.

High-level resistance to amikacin (MICs >256 mg/L) among the 30 Gram negative isolates was detected in 43.4% (13/30) by E test. They were 7 *E. coli* isolates (23.4%), 3 *Klebsiella pneumoniae* isolates (10%), 2 *Pseudomonas aeruginosa* isolates (6.7%) and one *Enterobacter cloaca* isolates (3.3%). The MICs of amikacin for the remaining isolates ranged between 48 and 64 µg/ml.

β- Lactamase characterization:

Among the 30 amikacin resistant Gram negative bacilli isolates, 7 (23.3%) isolates were ESBL-producer and they were *E.coli* (3/7; 42.8%), *Klebsiella pneumoniae* (2/7; 28.6%), *Enterobacter cloaca* and *Acinetobacter baumannii* (1/7; 14.3%, each).

Prevalence of methylases genes:

Seven out of 30 (23.3%) amikacin-resistant isolates were positive for 16S rRNA methylase genes, among which 6 isolates (20%; 6/30) were positive for rmtB gene and only one isolate (3.3%;1/30) was positive for armA gene (figure 1). ArmA was detected in one *Enterobacter cloaca* isolate (50 %;1/2), and rmtB was detected in five (33.3 %; 5/15) *E. coli* isolates and one (25%; 1/4) *Pseudomonas aeruginosa* isolate. ArmA and rmtB genes were not detected simultaneously.

ArmA gene was detected in one male patient (1/21; 4.8 %) while rmtB gene was detected in 5 (5/21; 23.8%) male patients and one (1/9; 11.1%) female patient. Their ages were ranged from 10 to 65 years. There was no statistically significant correlation between the detection of armA and rmtB genes and the sex of the patients (P value= 0.7 and P value=0.3, respectively). According to site of infection, armA-positive Gram negative bacilli isolates were detected in one urine (1/11; 9.1 %) sample, while rmtB positive isolates were detected in 2 urine (2/11; 18.2

%), 3 sputum (3/9; 33.3 %) and one wound (1/5; 20%) samples.

ArmA gene was detected in one ESBL-producer isolate (1/7; 14.3%), which was *Enterobacter cloaca*. RmtB gene was detected in 3 ESBL-producer isolates (3/7; 42.9%) and they were *E.coli* isolates. There was statistically significant correlation between the detection of methylase genes and the production of ESBLs (P value= 0.01).

All 16S rRNA methylase gene-positive isolates were highly resistant to amikacin (MICs >256 µg/mL). They were also resistant to gentamicin, tobramycin, kanamycin, netilmicin and neomycin (Table 2). The 16S rRNA methylase gene-positive isolates represent 53.8% (7/13) of the amikacin highly resistant Gram negative bacilli isolates. There was poor agreement between the phenotypic and genotypic characteristics (kappa= 0.6).

All 16S rRNA methylase gene-positive isolates were susceptible to imipenem. ArmA gene positive *Enterobacter cloaca* isolate was resistant to amoxicillin/clavulanic, piperacillin/tazobactam, cefuroxime, cefoxitin, ceftazidime, cefoperazon, cefotaxime, cefepime, aztreonam, ciprofloxacin, levofloxacin, norfloxacin, ofloxacin, trimethoprim-sulfamethoxazole and nitrofurantoin.

The 5 *E.coli* rmtB positive isolates were resistant to amoxicillin and ceftazidime and also they were resistant to amoxicillin/clavulanic, cefotaxime, cefepime except one isolate. *Pseudomonas aeruginosa* rmtB positive isolate was resistant to amoxicillin, amoxicillin/clavulanic, cefuroxime, cefoxitin, cefoperazon, cefotaxime, aztreonam, nalidixic acid, ciprofloxacin, and levofloxacin, intermediate to ceftriaxone, and susceptible to piperacillin/tazobactam, ceftazidime, cefepime and meropenem.

4. Discussion

Aminoglycosides are broad-spectrum antibiotics of high potency that have been traditionally used for the treatment of serious Gram-negative infections. However, increasing resistance to aminoglycosides is becoming a serious clinical problem (Yamane *et al.*, 2005 and Gad *et al.*, 2011).

Resistance to aminoglycosides is frequently due to the acquisition of modifying enzymes such as acetyltransferases, phosphorylases and adenyltransferases (Kotra *et al.*, 2000). Other mechanisms of resistance include ribosomal alteration and impaired uptake of the antibiotics (Yan *et al.*, 2004).

A series of special methylases that protect microbial 16S rRNA, the main target of aminoglycosides, was identified in several nosocomial pathogens (Yamane *et al.*, 2007). Six plasmid-encoded 16S rRNA methylases, including

ArmA, RmtA, RmtB, RmtC, RmtD, and NpmA, have been identified in clinical isolates of Gram-negative

bacilli from multiple geographic locations (Yu *et al.*, 2010).

Table (1): Distribution of the 30 amikacin-resistant Gram negative bacilli isolates According to Species, Specimen

Organism	Specimen					Department				
	Urine	Sputum	Wound Swab	Blood Culture	Ascitic Fluid	ICU	Urology	Surgery	Gastro enterology	Outpatient Clinic
<i>E.coli</i> (no.15)	6	4	2	1	2	3	2	0	4	6
<i>Klebsiella pneumoniae</i> (no.7)	2	3	2	0	0	1	1	2	0	3
<i>Pseudomonas aeruginosa</i> (no.4)	1	1	1	1	0	2	1	0	0	1
<i>Enterobacter cloaca</i> (no.2)	1	1	0	0	0	1	0	0	0	1
<i>Acinetobacter baumannii</i> (no.2)	1	0	0	1	0	2	0	0	0	0
Total (no.30)	11	9	5	3	2	9	4	2	4	11

Type and Origin

Table (2): Phenotypic and Genotypic Characteristics of Positive Mythylases Isolates

Specimen	Organism	Gene	AN	GM	NET	TOB	K	N	E Test	ESBL
Urine	<i>Enterobacter cloaca</i>	ArmA	R	R	R	R	R	R	>256	P
Sputum	<i>E.coli</i>	RmtB	R	R	R	R	R	R	>256	P
Wound	<i>E.coli</i>	RmtB	R	R	R	R	R	R	>256	N
Urine	<i>E.coli</i>	RmtB	R	R	R	R	R	R	>256	P
Urine	<i>E.coli</i>	RmtB	R	R	R	R	R	R	>256	N
Sputum	<i>Pseudomonas aeruginosa</i>	RmtB	R	R	R	R	R	R	>256	N
Sputum	<i>E.coli</i>	RmtB	R	R	R	R	R	R	>256	P

AN (Amikacin), GM (Gentamicin), NET (Netilmicin), TOB (Tobramycin), K (Kanamycin), N (Neomycin), R (Resistant), P (Positive), N (Negative).

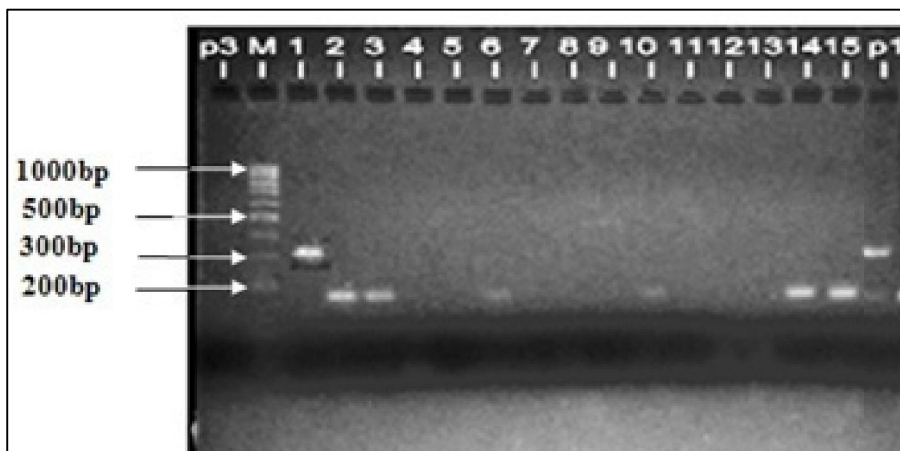

Figure (1): Detection of methylase genes in isolated gram negative bacilli: M=DNA weight (DNA ladder), P1=pooled positive 1, P3= pooled negative, and 1: 15 sample number

In this study, the prevalence of 16S rRNA methylases genes among the gram negative bacilli was determined by PCR. Thirty amikacin resistance Gram negative bacilli isolates were collected from outpatient and inpatient of TBRI. They were 21 (70%) males and 9 females (30%). The higher prevalence rate of aminoglycosides resistance in males (66.7%) than in females (33.3%) was also reported by Wassef *et al.*(2010) in an Egyptian study

included 45 Gram negative bacilli that show resistance to all aminoglycosides in the period from March to June 2008 in Kasr El-Aini hospital, Cairo.

The majority of isolates were recovered from urine specimens (36.7%). The remaining isolates were recovered from sputum (30%), wound swab (16.7%), blood culture (10%) and ascitic fluid (6.6%). This rate was comparable with another Egyptian study at Minia University Hospital in Egypt by Gad *et*

al. (2011) who tested the aminoglycoside resistance in 175 Gram-negative bacteria isolates in the period from 2007 to 2009 and reported that the urinary isolates were 34.2 %, while wound swab isolates were 17.7%. Batchoun *et al.* (2009) reported that urine was the major source of the bacterial isolates collected, comprising 56% (262/472) of the total isolates and isolates from swabs and blood culture were 16.9% (80/472) and 16.7% (79/472) respectively.

E.coli was the most frequently isolated species (50%), followed by *Klebsiella pneumoniae* (23.3%), then *Pseudomonas aeruginosa* (13.3%). *Enterobacter cloaca* and *Acinetobacter baumannii* were equally isolated (6.7% each). Similar finding have been reported in the two Egyptian studies by Wassef *et al.* (2010) and Gad *et al.* (2011) who noted that, the most frequently isolated aminoglycosides resistance species was *E.coli* (39.6% and 28.57%) followed by *Klebsiella pneumoniae* (38.6%), then *Pseudomonas aeruginosa* (13.4% and 25.7%) respectively.

E.coli was isolated from urine, sputum, wound swab, blood culture and ascitic fluid specimens in percent of 40%, 26.7%, 13.3%, 6.7% and 13.3% respectively. Similar results were obtained by Wassef *et al.* (2010), who reported an isolation rate of 39.6% of *E.coli* from urine. Gad *et al.* (2011) noted slightly higher isolation rate of *E.coli* from urine (50%) while in skin infection was comparable with our results (12%).

Klebsiella pneumoniae was equally (28.6%) isolated from urine and wound swab specimens. *Pseudomonas aeruginosa* was equally isolated (25%) from urine, sputum, and wound swab and blood culture specimens. These results are in accordance with the findings of Gad *et al.* (2011) who reported equal isolation of *Klebsiella pneumoniae* from urine and wound swab specimens (37.5%) while the isolation rate of *Pseudomonas aeruginosa* from urine and skin infection were 22.2% and 20% respectively.

In our study, 7 (23.3%) isolates were ESBL-producer. A similar finding was reported by Batchoun *et al.* (2009) who noted that, out of the 472 gram-negative isolates included in their study, 108 (22.9%) isolates were ESBL producers. However, very high isolation rate 93.3% (42/45) was detected in Wassef *et al.* (2010) study. This may be attributed to that ESBLs was detected in the 45 gram-negative isolates that showed high-level amikacin resistance, while in our study it was detected in all 30 amikacin resistance gram-negative isolates regardless the level of resistance.

In the present study, ESBLs-producer isolates were *E.coli* (42.8%), *Klebsiella pneumoniae* (28.6%) and *Enterobacter cloaca* and *Acinetobacter baumannii* (14.3%, each). Many studies reported the detection of ESBLs-production isolates in *E.coli* (39.1%) (Moyo

et al., 2010), *Klebsiella pneumoniae* (17.2%) (Gangoué-piéboji *et al.*, 2005) and *Enterobacter cloaca* (13.9%) isolates (Batchoun *et al.*, 2009).

In this study, *E.coli*, *Klebsiella pneumoniae*, *Pseudomonas aeruginosa* and *Enterobacter cloaca* were resistant to amikacin, gentamicin, tobramycin, kanamycin, and netilmycin antibiotic discs. Similar findings were reported by Gad *et al.* (2011). It was found that 46.6 % of *E. coli* isolates and 33.3% of *K. pneumoniae* isolates demonstrated high-level resistance to amikacin (MICs >256 mg/L) in our study. These results are comparable with the findings of Yan *et al.* (2004) who reported that, 50% of *E. coli* isolates and 39.6% of *K. pneumoniae* isolates demonstrated high-level resistance to amikacin.

On the other hand, 50% (1/2) of *E. cloaca* isolates demonstrated high-level resistance to amikacin (MICs >256 mg/L) in this study while Kang *et al.* (2008) reported lower prevalence (8.7%) in a study done in a university hospital in South Korea between 1995 and 2006. The high prevalence of highly-level resistance *E. cloaca* isolates in our study could be attributed to lower number of samples in comparison to the larger numbers of the isolates and the longer duration of the South Korean study. However, the prevalence in some periods of this study was elevated to 31% in 1997 and to 40% in 1998.

In this study *Pseudomonas aeruginosa* demonstrated high-level resistance to amikacin (50%). This result was higher than that described in a Japanese study (4.4%) presented by Yamane *et al.* (2007). Their low prevalence rate could be referred to higher geographic distribution of clinical specimens collected from 16 hospitals and the higher number of isolates (384) in comparison to lower numbers (2/4) in our study. Yamane *et al.*, 2007 used a different method including LB agar plates supplemented with 500 mg of arbekacin per liter while in our study amikacin E test was used.

In our study, no *Acinetobacter baumannii* isolates demonstrated high-level resistance to amikacin. Similar results were obtained from a study conducted on *Acinetobacter* isolates collected from Europe, North America, and Latin America. They reported no detection of methyltransferases among the *Acinetobacter* species isolates during the study period from 2005 to 2006 (Fritsche *et al.*, 2008). In contrast, a Japanese study presented by Yamane *et al.* (2007), reported a higher level of resistant (12.1%) among *Acinetobacter* species isolates. Also, Doi *et al.* (2007) reported a detection of five highly amikacin-resistant *Acinetobacter baumannii* isolates in a study done between December 2006 and March 2007 at a medical center in North America. They reported that

the aminoglycoside resistance was due to the production of the 16S rRNA methylase ArmA.

ArmA gene was detected in one *Enterobacter cloacae* isolate out of 30 amikacin resistance isolates (3.3%; 1/30). These results are similar to the findings of Yamane et al. (2007) who reported that armA gene was detected in one *E. cloacae* isolate out of 29 highly resistance isolates to amikacin (3.4%; 1/29). Also, Kang et al. (2008) reported that the detection rate of armA in *Enterobacter cloacae* was 4.1% (19/463) in a study done to detect the 16SrRNA methylase genes in amikacin resistant Enterobacteriaceae isolates that were collected in 1995 to 2006 at university hospital in South Korea. Other studies reported a detection rate of armA in *Enterobacter cloacae* isolates of 2.9% (1/34) and 2.98% (6/201) respectively (Galimand et al., 2005 and Wu et al., 2009). However, Fritsche et al. (2008) reported higher prevalence of armA gene as it was detected in two *Enterobacter cloacae* isolates out of 22 amikacin resistance isolates (9%; 2/22).

In the present study, the prevalence of armA among *Enterobacter cloacae* was 50% (1/2) and was isolated from urinary sample. These results are in accordance with Kang et al. (2008) who reported that the detection rate of armA among *Enterobacter cloacae* isolates was 45.2% (19/42) in a long period study done in amikacin resistant Enterobacteriaceae isolates that were collected in 1995 to 2006 at university hospital in South Korea. However, Galimand et al. (2005) and Yamane et al. (2007) reported that a higher prevalence rate 100% (1/1) was detected among amikacin resistant *Enterobacter cloacae* isolates. This may be attributed to the small numbers of isolates used in these studies. Yamane et al. (2007) noted that the armA-positive *Enterobacter cloacae* isolate was detected in a urinary sample. Wu et al. (2009) reported that the prevalence rate of armA in *Enterobacter cloacae* was 25% (6/24) in Shanghai, China. This lower prevalence rate of armA may be due to the higher samples size in this study.

In the present study, the prevalence of rmtB gene in amikacin resistant isolates was 20%. These results are in accordance with Kang et al. (2008) who reports that the detection rate of rmtB was 23.3 % (51/218) among amikacin resistant isolates. Nearly similar to our results, Wassef et al. (2010) who reported that the detection rate of rmtB was 15.1% among 45 amikacin resistant isolates. Different prevalence rates of rmtB gene in amikacin resistant isolates were reported, in Taiwan it was 8.6% (Yan et al., 2004), 36.4% in North and South America Fritsche et al., 2008 and in China were 10.9% (Wu et al., 2009) and 84% (Yu et al., 2010).

In our study, rmtB was detected in five *E. coli* (5/15; 33.3%) amikacin-resistant isolates. These

results are comparable with Kang et al. (2008) who reported that the RmtB was detected in 34.6% (18/52) of amikacin resistant *E. coli* isolates. However, Yu et al. (2010) reported higher rmtB gene detection rate (81.8%; 36/44) which indicates higher spread of rmtB gene carrying plasmid in the isolated *E. coli*. One (1/4; 25%) *Pseudomonas aeruginosa* isolate was rmtB positive in our study. Similar finding was reported by a Japanese study presented by Yokoyama et al. (2003). Other studies reported that no rmtB gene was detected among the amikacin resistant *Pseudomonas aeruginosa* isolates (Yamane et al., 2007 and Fritsche et al., 2008).

In our study, no rmtB gene was detected in *Klebsiella pneumoniae*, *Enterobacter cloacae* or *Acinetobacter baumannii* isolates. Similar findings were reported by many studies (Doi et al., 2007, Yamane et al., 2007 and Kang et al., 2008). However, some studies reported that rmtB was detected in *Klebsiella pneumoniae* in rates of 8.6% and 20% respectively (Yan et al., 2004 and Fritsche et al., 2008).

In our study, rmtB gene-positive *E. coli* isolates were isolated from 2 sputum (40%); 2 urinary (40%) and (20%) one wound samples. Nearly similar finding were reported by Yu et al. (2010) who noted that rmtB gene-positive isolates was detected in 36 clinical samples in a rate of 44.4% and 27.8% for urinary and pus samples respectively, however, lower prevalence of rmtB in sputum samples (2.8%; 1/36) was detected.

In our study, the associations between 16S rRNA methylase and ESBLs production were detected in a rate of 66.7%. The armA-positive *Enterobacter cloacae* isolate was ESBLs producers and the three (60%; 3/5) rmtB-positive *E. coli* isolates were ESBLs producers. Many studies reported the associations between 16S rRNA methylase and ESBLs production with different rates ranging from 78.4% (Yan et al., 2004), 94.3% (Yu et al., 2010) to 100% (Wassef et al., 2010)

In our study, all 5 *E. coli* isolates harboring 16S rRNA methylase genes were resistant to ciprofloxacin and susceptible to imipenem. Similar results were reported in Chinese study presented by Yu et al. (2010) who noted that all isolates harboring 16S rRNA methylase genes were resistant to ciprofloxacin, and susceptible to imipenem. Yan et al. (2004) reported that all armA-positive and rmtB positive isolates recovered were susceptible to imipenem. However, nine of the 28 (32.1%) armA-positive isolates and six of the seven (85.7%) rmtB positive isolates were resistant to ciprofloxacin. This could be explained by the use of MIC method to determine the susceptibility of isolates to ciprofloxacin in the Taiwanese study while in our

study disc diffusion method was used. This Clinical data supports the use of carbapenems for treatment of infections due to 16S rRNA methylase associated with ESBL-producing organisms. However, in a study in Pennsylvania presented by Doi *et al.* (2007), *armA* was detected in two *Acinetobacter baumannii* isolates coproduced OXA-23 β -lactamase and were highly resistant to carbapenems.

In our study, *rmtB* was more prevalent (20%; 6/30) than *armA* (3.33%; 1/30) among amikacin resistance isolates. Similar results were obtained from china by Doi *et al.* (2004) and Wu *et al.* (2009) who reported that *rmtB* was found to be more prevalent than *armA* in their hospitals. However, Yan *et al.* (2004) in a Taiwanese study and Wassef *et al.* (2010) in an Egyptian study suggest that *armA* is more prevalent than *rmtB* amongst Enterobacteriaceae isolates. Wassef *et al.* (2010) attributed the apparently higher prevalence of *armA* compared with that of *rmtB* in his study and the Taiwanese study to its association on the same conjugative plasmid with the gene for CTXM- 3 and its location on the functional transposon Tn1548. It worthy mentioned that ESBLs isolation rate was very high (93.3%) in Wassef *et al.* (2010) (16) study.

In our study there was poor correlation between the phenotypic pattern of aminoglycosides resistance detected by disk diffusion test and the genotypic pattern of resistance that was detected in (7/13; 53.8%) among high-level resistance to amikacin (MICs >256 mg/L) isolates. Similar finding was reported by Wassef *et al.* (2010) who noted a correlation in only 24.2% of bacterial isolate. On the other hand, a higher correlation record (95.5%) was detected in a surveillance study performed in Europe, North America, and Latin America. This could be attributed to the usage of nine aminoglycosides including arbekacin aminoglycoside modifying enzymes and a high-level arbekacin resistance (MIC >512 mg/L) was used as for screening the 16S rRNA methylase-producing strains (Pe'richon *et al.*, 2010). The findings reported by Wassef *et al.* (2010) was explained by the presence of other causes of aminoglycosides resistance in the PCR negative isolates such as the enzymatic modification and the absence of arbekacin in the selective criteria as arbekacin enhance the chance for detection of the 16S rRNA methyltransferases causative genes. This could be an acceptable explanation for our study also as the conditions were nearly similar.

Plasmid-mediated *armA* and *rmtB* genes have been identified from *E. coli* in swine from Spain and China (Gonzalez-Zorn *et al.*, 2005 and Chen *et al.*, 2007). In China, it was reported that the emergence of the *armA* and *rmtB* genes in clinical isolates of *E. coli* found in chickens (Du *et al.*, 2009). A large amount

of aminoglycosides has been consumed in veterinary medicine. This may have served as a selective pressure for enteric gram-negative organisms to acquire 16S rRNA methylase genes, possibly from nonpathogenic environmental actinomycetes that intrinsically produced aminoglycosides or similar 16S rRNA inhibitors, and then maintain and spread them to humans through the food supply chains (Doi and Arakawa, 2007).

Conclusion

16S rRNA methylase genes were detected in gram negative bacilli in TBRI. *RmtB* was found to be more prevalent than *armA*. There was correlation between the detection of methylase genes and the production of ESBLs the aminoglycoside resistance produced by methylase and the association of their genes with mobile elements will require enhanced laboratory capabilities for their detection, appropriate infection control practices to limit continued spread, and reliance on alternative chemotherapeutic agents including carbapenems for treatment of infections due to 16S rRNA methylase associated with ESBL-producing organisms. The developments of new aminoglycoside agents that bind to methylated ribosomes are critically needed.

Corresponding authors

Manal El Said

Microbiology Department, Theodor Bilharz Research Institute, Giza, Egypt. Theodor Bilharz Research Institute

manalmicrobiology@yahoo.com

Reference

1. **Batchoun, R. G., Swedan, S. F., Shurman, A.M., 2009.** Extended Spectrum β -Lactamases among Gram-Negative Bacterial Isolates from Clinical Specimens in Three Major Hospitals in Northern Jordan. *Int. J. Microbiol.* 1-8.
2. **Chen, L., Chen, Z.-L., Liu, J.H., Zeng, Z.-L.; Ma, J.-Y.; Jiang, H.-X., 2007.** Emergence of *RmtB* methylase producing *Escherichia coli* and *Enterobacter cloacae* isolates from pigs in China. *J. Antimicrob. Chemother.* 59, 880–885.
3. **Clinical and laboratory standards institute (CLSI) 2010.** Performance standards for antimicrobial susceptibility, Twentieth informational supplement M100-S20. Clinical and Laboratory Standards Institute, Wayne, Pennsylvania (USA).
4. **Doi, Y., Yokoyama, K., Yamane, K., Wachino, J., Shibata, N., Yagi, T., et al., 2004.** Plasmid-mediated 16S rRNA methylase in *Serratia marcescens* conferring high-level resistance to aminoglycosides. *Antimicrob. Agents Chemother.* 48 (2), 491–496.
5. **Doi, Y., Adams, J. M., Yamane, K., Paterson, D. L., 2007.** Identification of 16S rRNA methylase-producing *Acinetobacter baumannii* clinical strains in North America. *Antimicrob. Agents Chemother.* 51(11), 4209–4210.

6. **Doi, Y., Arakawa, Y., 2007.** 16S ribosomal RNA methylation: emerging resistance mechanism against aminoglycosides. *Clin. Infect. Dis.* 45, 88–94.
7. **Du X.-D., Wu, C.-M., Liu, H.-B., Li, X.-S., Beier, R.C., Xiao F., et al., 2009.** Plasmid-mediated *ArmA* and *RmtB* 16S rRNA methylases in *Escherichia coli* isolated from chickens. *J. Antimicro.Chemother.*10,1093.
8. **Ercolini, D., 2004.** PCR-DGGE fingerprinting: novel strategies for detection of microbes in food. *J. Microbiol. Methods.* 56, 297–314.
9. **Fluit, A.D. C., Visser M. R., Schmitz, F.-J., 2001.** Molecular Detection of Antimicrobial Resistance. *Clin. Microbiol. Reviews.* 14(4), 836–871.
10. **Fritsche, T.R., Castanheir, M., Miller, G.H., Jones, R.N., Armstrong, E.S., 2008.** Detection of Methyl transferases Conferring High – Level Resistance to Aminoglycosides in Enterobacteriaceae from Europe, North America, and Latin America. *Antimicrob. Agents and Chemother.* 52 (5), 1843 - 1845.
11. **Gad, G. F., Mohamed, H. A., Ashour, H.M., 2011.** Aminoglycoside Resistance Rates, Phenotypes, and Mechanisms of Gram-Negative Bacteria from Infected Patients in Upper Egypt. *PLoS ONE*, 6(2),1-7.
12. **Galimand, M., Sabtcheva, S., Courvalin, P., Lambert, T., 2005.** Worldwide disseminated *armA* aminoglycoside resistance methylase gene is borne by composite transposon *Tn1548*. *Antimicrob. Agents Chemother.* 49(7), 2949–2953.
13. **Gangoué-Piéboji, J., Bedenic, B., Koulla-Shiro, S., Randegger, C., Adiogo, D., Ngassam, P., et al., 2005.** Extended-Spectrum β -lactamase producing *Enterobacteriaceae* in Yaoundé, Cameroon. *J. clin. Microbiol.* 43(7), 3273-3277.
14. **Gonzalez-Zorn, B., Catalan A., Escudero, J.A., Dominguez, L., Teshager, T., Porrero, C., et al., 2005.** Genetic basis for dissemination of *armA*. *J Antimicrob Chemother.* 56,583–585.
15. **Head, I.M., Saunders, J.R., Pickup, R.W., 1998.** Microbial evolution, diversity, and ecology: a decade of ribosomal analysis of uncultivated microorganisms. *Microb. Ecol.* 35, 1–21.
16. **Kang, H.Y., Kim, K.Y., Kim J., Lee, J. C., Lee, Y C., Cho, D. T., et al., 2008.** Distribution of Conjugative -Plasmid-Enterobacteriaceae Isolates Collected in 1995 to 1998 and 2001 to 2006 at a University Hospital in South Korea and Identification of Conjugative Plasmids Mediating Dissemination of 16S rRNA Methylase. *J. Clin Microbiol.* 46(2), 700 - 706.
17. **Kotra, L.P., Haddad, J., Mobashery, S., 2000.** Aminoglycosides perspectives on mechanisms of action and resistance and strategies to counter resistance. *Antimicrob. Agents Chemother.*44(12), 3249–3256.
18. **Moyo, S. J., Aboud, S., Kasubi, M., Lyamuya, E.F., Maselle, S. Y., 2010.** Antimicrobial resistance among producers and non-producers of extended spectrum betalactamases in urinary isolates at a tertiary Hospital in Tanzania. *BMC Research Notes.* 3, 328.
19. **Pe'richon, B., Courvalin, P., Galimand M., 2007.** Transferable Resistance to Aminoglycosides by Methylation of G1405 in 16S rRNA and to Hydrophilic Fluoroquinolones by QepA-Mediated Efflux in *Escherichia coli*. *Antimicrob. Agents Chemother.*51(7),2464–2469.
20. **Pitout, J.D., Reisbig, M.D., Venter, E.C., Church, D.L., Hanson, N.D., 2003.** Modification of the double-disk test for detection of *Enterobacteriaceae* producing extended-spectrum and AmpC β -lactamases. *J. Clin Microbiol.*41, 3933–3935.
21. **Wachino, J.-i., Yamane, K., Shibayama, K., Kurokawa, H., Shibata, N., Suzuki, S., et al., 2006.** Novel Plasmid Mediated 16S rRNA Methylase, *RmtC*, Found in a *Proteus mirabilis* Isolate Demonstrating Extraordinary High-Level Resistance against Various Aminoglycosides. *Antimicro Agents and Chemother.*50 (1), 178 – 184.
22. **Wassef, M.A., El sheriff, R.H., El Shenoufy, A.E, Ghaith, D.M., 2010.** Phenotypic and Genotype patterns of aminoglycoside Resistance in Gram negative bacilli. *J. American Science.* 6(9),781-786.
23. **Wu., Q., Zhang, Y., Han, L., Sun, J., Ni, Y., 2009.** Plasmid-mediated 16S rRNA methylases in aminoglycoside-resistant Enterobacteriaceae isolates in Shanghai, China. *Antimicrob Agents Chemother.*53(1),271-272.
24. **Yamane, K., Wachino, J., Doi,Y., Kurokawa, H., Arakawa, Y., 2005.** Global spread of multiple-aminoglycoside-resistance genes. *Emerg Infect Dis.* 11(6), 951–953.
25. **Yamane, K., Wachino, J.-I., Suzuki, S., Shibata, N., Kato, H., Shibayama, K., et al., 2007.** 16S rRNA Methylase – producing, Gram – negative pathogens Japan. *Emerg Infect Dis.* 13(4), 642-646.
26. **Yan, J.J, Wu J.J., Ko, W.C., Tsai, S.H., Chuang, C.L., Wu.,H.M., et al., 2004.** Plasmid-mediated 16S rRNA methylases conferring high-level aminoglycoside resistance in *Escherichia coli* and *Klebsiella pneumoniae* isolates from two Taiwanese hospitals. *J. Antimicrob. Chemother.* 54(6),1007–1012.
27. **Yokoyama, K., Doi, Y., Yamane, K., Kurokawa, H., Shibata, N., Shibayama, K., et al., 2003.** Acquisition of 16S rRNA methylase gene in *Pseudomonas aeruginosa*. *Lancet*, 362:1888-1893.
28. **Yu, F.-y., Yao D., Pan J.-y., Chen,C., Qin Z.-q., Parsons C., et al., 2010.** High prevalence of plasmid-mediated 16S rRNA methylase gene *rmtB* among *Escherichia coli* clinical isolates from a Chinese teaching hospital. *BMC Infec. Dis.* 10,184.

10/1/2012

Evaluation of non-functional characteristics of web-based systems modeled and designed using aspect-oriented technology by aspectual software architecture analysis method (ASAAM)

Davood Karimzadganmoghadam¹, Davood Vahdat², Mohammad Pira³, Reza Askari moghadam⁴

¹. Department of IT, Payame Noor University, Tehran, Iran, d_karimzadgan@pnu.ac.ir

². Department of IT, Payame Noor University, Tehran, Iran, vahdat@pnu.ac.ir

³. Department of IT, Payame Noor University, Tehran, Iran, Mohammadpira408@yahoo.com, Corresponding Author, Msc

⁴. Faculty of New Sciences and Technologies University of Tehran, Tehran, IR Iran, P.O.Box:14395-1561, r.askari@ut.ac.ir

Abstract: Despite the importance and well-known status of non-functional requirements in the success of Web applications in the field of Web Engineering, they do not receive much attention. In many cases, these requirements remain pending, unconsidered, un-analyzed and undesigned after determining in the requirements engineering phase until completing application implementation. The aim of the present study is to model and analysis the non-functional requirements in designing Web applications. This will be done to ensure providing an architecture which supports the necessary quality characteristics of these applications. To realize the nature of these requirements, we focused on a large industrial case study which is a Web-based organizational application. It was observed that the majority of non-functional requirements in the Web applications architecture are intersecting concerns which should be modeled separately. However, this issue has not received necessary attention. Finally, the proposed architecture has been presented and evaluated.

[Davood Karimzadganmoghadam, Davood Vahdat, Mohammad Pira, Reza Asgarimoghadam. **Evaluation of non-functional characteristics of web-based systems modeled and designed using aspect-oriented technology by aspectual software architecture analysis method (ASAAM)**. *Life Sci J* 2012;9(4):2480-2486]. (ISSN: 1097-8135). <http://www.lifesciencesite.com>. 366

Keywords: Concern; Requirement; Web-pages; System Architecture; Continuity; Aspect.

1. Introduction

Keep pace with technological advances, the dependence on information technology is increased and relationships become more complex. Since rapid and safe access to information is vital where success or failure of business and industry depends on it, Web-based systems have a special place. Using this technology, experts and organizations managers can access to needed information from anywhere in the world. Also, using this technology, organizational costs reduce significantly which is considered as an important issue.

Web engineering suggests an agile but also systematic framework for constructing high quality applications and industrial Web-based systems (Pressman, 2010). In developing these systems, we deal with functional and non-functional requirements. Functional requirements represent system's performances. In fact, functional requirements are the concrete and usable system capabilities so that the user could perform its duties in the organization. Non-functional requirements or quality characteristics are related to the system performance. These requirements are rather concerned by system developers. If these two requirements are not dependent and modeled, the costs of system development and maintenance increase significantly.

Concern is an aspect of a problem which is important for stakeholder or stakeholders (Mancona, 2003). Concerns are often confused with requirements, although they are different, basically (Jacobson and Pan-Wei, 2005). Intersecting concerns are observed when the functional and non functional concerns are intertwined and not be able to module separately. Finding the intersecting concerns is a difficult task, thus designing and developing the system becomes difficult (Francescomarino and Tonella, 2009). Object-oriented approach is the dominant method for designing the systems. But, despite all its advantages and privileges, it is not able to module non-functional concerns, properly. Finally, it is observed that the non-functional concerns are scattered in the functional concerns.

Some techniques have been proposed to resolve this drawback of object-orientation including aspect-oriented programming (AOP), combination filters (CF), multidimensional separation of concerns (MDSOC) and adaptive programming (AP) (Chitchyan and Ruzanna, 2005). In the present study, aspect-oriented programming was selected. Since the language of developing this subsystem is Java, the AspectJ programming language was used. This has added the object-orientation concepts to Java. Aspect-oriented programming was introduced by

Mr. Gregory Kyzals and his group in 1997 (Kiczales and Hilsdale, 2001). Aspect-oriented programming is a technology which supports separation of intersecting concerns (Augusto and Lemos, 2011). With this language, functional and non functional concerns can be modeled. Thus, the process considerably lowers the cost of system maintenance. It also facilitates understanding architecture and the system code for program developers and improves system performance and security.

Software architecture is defined as a set of important design decisions about the system (Medvidovic and Dashofy, 2007). Software architecture plays a fundamental role in overcoming the inherent difficulties of developing large scale complex software systems (Kiczales and Lamping, 1997).

Aspectual Software Architecture Analysis Method (ASAAM) was selected for evaluating the system architecture (Pressman, 2010). Using this method, we can assess the improvement of the architecture compared to the original architecture. At the end of the study, with the help of calculations, it is shown that the system architecture has been improved significantly compared to the original architecture.

2. Case Study

"Comprehensive web-based organizational resources planning system" is a medium scale web-based application. This system consists of 11 subsystems including the financial management, production management, sales management, purchasing management, warehouse management, human resources management, management, maintenance, quality control, project management and office automation. The system has been designed based on architectural patterns of Layering, Domain Model, Data Mapper and MVC in order to exploit in organizations with 3,000 to 4,000 personnels. Fig. 1 shows the system architecture.

Due to the enormous volume of this web application, much attention has been paid to human resources management subsystem during conducting present study. The process model for web applications engineering is an agile version of the general software process model. System development process is an agile and model-oriented process. This process develops the system in terms of functional requirements systematically. However, this process of development acts occasionally for providing non-functional requirements. So that after implementation of each functional scenario, the mechanisms of providing non-functional requirements are programming in the code modules of the scenario repeatedly, non-coherently. The basic architecture of the case study is shown in Fig. 3.

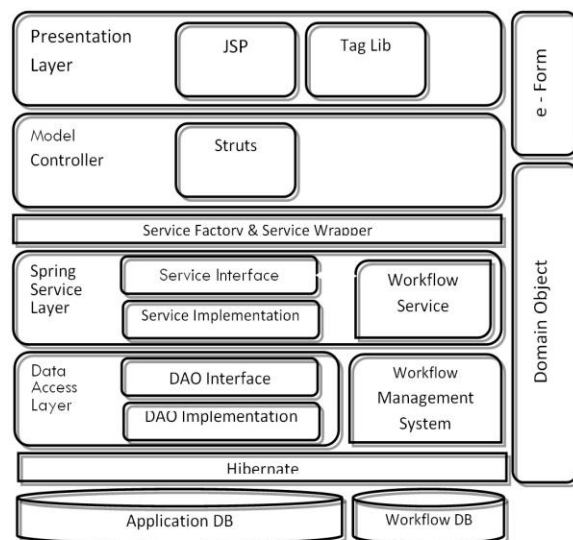

Figure 1. Layered architecture of the comprehensive web-based organizational resources planning system

3. Redesign

The case study was redesigned using an aspect-oriented process presented for developing web-based organizational applications considering the two non-functional requirements of security and response-time. These requirements are important in the current situation of the system. According to improvement process, after diagnosis of non-functional requirements with being aspect capability, their subsystem scenarios, i.e. the operational non-functional and controllable non-functional concerns must be compiled. Table 1 represents the corresponding scenario of these concerns for the case study.

After compiling these scenarios, the web-based organizational application architecture is developed by defining aspect-oriented components for moduling non-functional requirements with aspecting capabilities intersecting concerns of the application architecture. These components are described using UML 2.0.

In the next step, each modeled concern has been implemented using aspect-oriented programming independent of the core functional concerns. Fig. 3 shows a part of simplified sample code.

In the basic architecture, the components including core functional concerns, operational non-functional and controllable non-functional are intersecting i.e. the scattering and complexity of the concerns is observed throughout the architecture.

The architecture of this subsystem has been improved by aspect-oriented injection of non-functional requirements to its development process.

The obtained architecture is shown in Fig. 4 as the proposed architecture.

The architecture obtained from this improved process consists of two orthogonal layers. The first layer is the basic architecture of Web application. This layer is developed using conventional method of Web Engineering merely to achieve functional goals based on core functional concerns. The second layer is responsible for modeling non-functional application requirements as aspect-oriented components. Finally, the two layers are combined together by provided infrastructures in the aspect-oriented programming after independent development, and represent the final product. It is expected that the new architecture be more improved than the previous architecture version.

Table 1: A functional scenario

Scenario No	S120
Scenario Type	Core non-functional concern
Scenario Title	Calculation of group salary
Scenario Description	<p>At first, a list of organization employees is displayed based on required filters. Then, some (or all) employees are selected from the list. Salary calculation is performed for each employee according the following procedure:</p> <ol style="list-style-type: none"> 1 – a blank salary list corresponding to the current salary period is constructed for each employee. 2 - Employment certificate of the personnel which is active in the current salary period is retrieved. 3 - A list of salary elements defined in the employment certificate is retrieved. 4 – A salary item is constructed for each retrieved salary elements. This item is determined based on the specified the calculation method.

4. Evaluation Method Selection

Evaluation of the software is critical for meeting the quality requirements of the system. In software projects, as soon as a bug discovered in the project, as the costs of correcting and maintenance of the software will be reduced. Thus, assessment has a special place. Basically, architecture evaluation is performed after defining the architectural decisions before the implementation phase. Software architecture evaluation can be done in two times: early, late (Clements and Kazman, 2006). Early architecture evaluation can be carried out when architecture not still fully implemented. The late architecture is performed when the architecture has been well designed.

The basic parameters of the software architecture evaluation include: minimum coupling, maximum continuity, completeness, being understood, adaptability, realism (Garland and Anthony, 2003).

Coupling is the number of dependencies between two subsystems. If dependencies between the subsystems were less, the subsystems are independent. Continuity is the number of dependencies within components of a subsystem. If the subsystem consists of a lot of connected components, its continuity is high. If the subsystem consists of irrelevant components, its continuity is low. The software architecture must be completed to meet all functional and non-functional requirements of the system. The software architecture must be understandable for various stakeholders. The components of the software architecture must be compatible and consistent. Finally, the software architecture must be implementable.

The following items are of the advantages of evaluation: gathering the project stakeholders, prioritizing conflicting objectives, obligation to provide a clear architectural, improvement of software architecture (Clements and Kazman, 2006). There are four techniques categories for evaluating software architecture which are briefly described. These techniques are: experimental techniques, simulation, questioner and measurement techniques.

In experience-based techniques, evaluations are carried out based on knowledge and experience of developers and evaluators according to the past projects. This method is based on interviews with system stakeholders and use of their experiences (Jeong and Kim, 2006). Because of inconsistencies in stakeholders' statements and non-technicality of the results of interviews and evaluations, addressing this method is neglected in the present study.

The prototype is used in the simulation technique. Prototype is a sample which provides non-performance user interface. The users may check it to ensure providing their requirements by the system. The simulation method is used to measure the performance. These methods need to implement components of the architecture and simulating other components for architecture implementation. Therefore, they need information about the underdevelopment system which is not available during the development and architectural design. Also, these methods are expensive. Moreover, many important features of the system, especially non-functional features such as storage capacity, reliability and error educability cannot be instantiated.

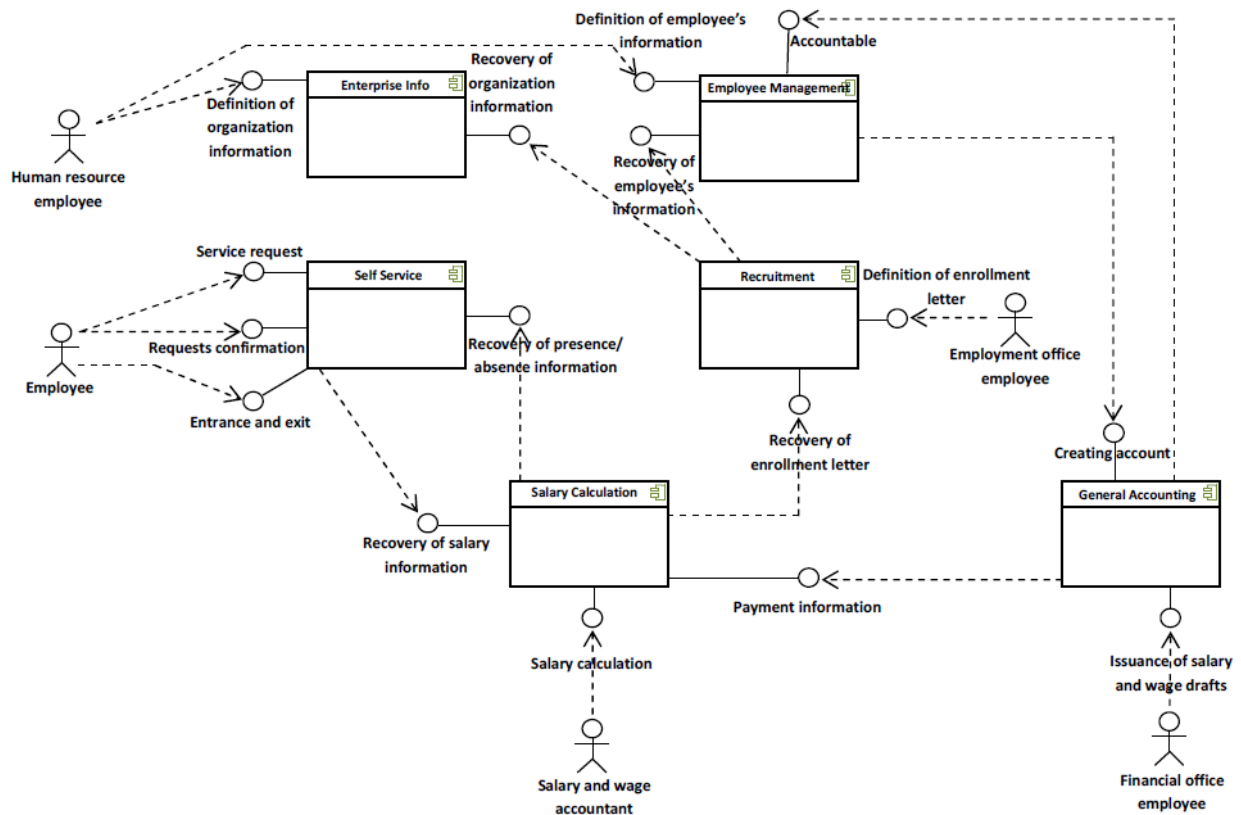

Figure 2. Basic architecture of human resources management subsystem

```

protected abstract void preprocess(ActionMapping mapping, ActionForm actionForm,
    HttpServletRequest request, HttpServletResponse response) throws Exception;

protected abstract ActionForward process(ActionMapping mapping, ActionForm actionForm,
    HttpServletRequest request, HttpServletResponse response);

protected abstract void postprocess(ActionMapping mapping, ActionForm actionForm,
    HttpServletRequest request, HttpServletResponse response)
    throws Exception;

public ActionForward execute(ActionMapping mapping, ActionForm actionForm,
    HttpServletRequest request, HttpServletResponse response) {

    //Business Logic
    preprocess(mapping, actionForm, request, response);
    ActionForward forward =
        SalaryCalculationService.calculateSalary
            (mapping, actionForm, request, response);
    postprocess(mapping, actionForm, request, response);
    return forward;
}
    
```

Figure 3. Part of the applied code for salary calculation in Model Controller layer after applying the proposed aspect-oriented development process

Measurement methods use mathematical equations and expressions. These methods evaluate the software architecture based on measurable quality characteristics. Measurement techniques express questions with measurable answers. However, because measuring the questioned values is a difficult task in the software design stage and it is limited to some small qualitative characteristics, these techniques are not widely used as questioning techniques.

In questioning techniques, questions are expressed about the quality of the architecture (These questions can be expressed in the form of checklists or scenarios). Because these questions are qualitative, their answers cannot be accurately determined. But, they can be used for relative comparison of several items. In this study, the questioning technique was used for evaluation.

Questioning techniques consist of three techniques including scenarios, questionnaires and checklists. Scenario is a technique for determining the requested quality of the architecture. Six components are available for consistenting and normalizing different scenarios to the standard scenario. This will facilitate the evaluation processes i.e. stimulus source, stimulus, environment, product, response, response measurement (Clements and Kazman, 2006).

One of the advantages of the scenarios is that they are specific to a particular system. Each software system needs a certain degree of quality with respect to their duties. Therefore, the expected quality level of the system should be determined according to the type of system tasks. Architecture evaluation by scenarios is such that it is determined whether the architecture can meet the desired scenarios or not.

The SAAM can be considered as the first scenario-based software architecture evaluation method. This architecture evaluation method is used in terms of non-functional requirements. The goal of SAAM is to provide a method for evaluating the quality features of the architecture versus the available documentation of the system requirements. If the SAAM is employed for the architecture, the strengths and weaknesses of the architecture, and the failed points in the terms of change capability will be determined. If the method is used for two or more architectures, it will compare the architectures in terms of change capability.

For evaluation by the SAAM, the non-functional scenarios that need to be evaluated must be identified and numbered. The software architecture should be briefly outlined. If more details of the architecture are needed during the evaluation, the architecture will be developed.

At the end of the SAAM evaluation, mapping between scenarios and architecture and its changing costs will be presented in order to identify sensitive areas of the architecture which have the potential to change. Also, understanding of the system performance is completely done. Furthermore, a comparison between the architectures and the level of their support from the system performance is presented at the end of evaluation.

Assessment Team of SAAM: Assessment Team is composed of three groups:

- i - External stakeholders are the owners and users of the system who are involved in providing commercial purposes.
- ii - Internal stakeholders: system developers including the architect and the architectural team who have direct role in software architecture providing and analyzing.
- iii - SAAM Team: the architecture evaluation team which do the evaluation task.

Before implementing SAAM, a brief explanation is given about the system functionality and the main purpose of the system. Then evaluation process is started. SAAM consists of 6 stages i.e. scenario development, architecture description, classification and prioritization of scenarios, evaluating scenarios, obtaining communication between the scenarios and providing the overall assessment.

ASAAM has been developed by expanding the SAAM method in order to identify architectural features using the scenarios. Fig. 5 shows the ASAAM activities.

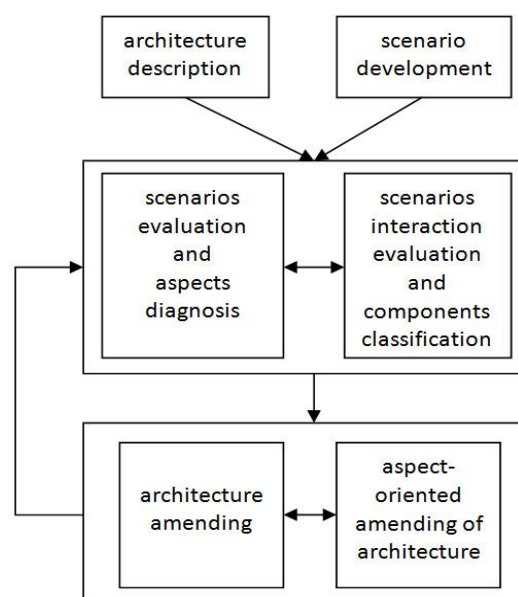

Figure 5. Activity of ASSAM (Tekinerdogan, 2004)

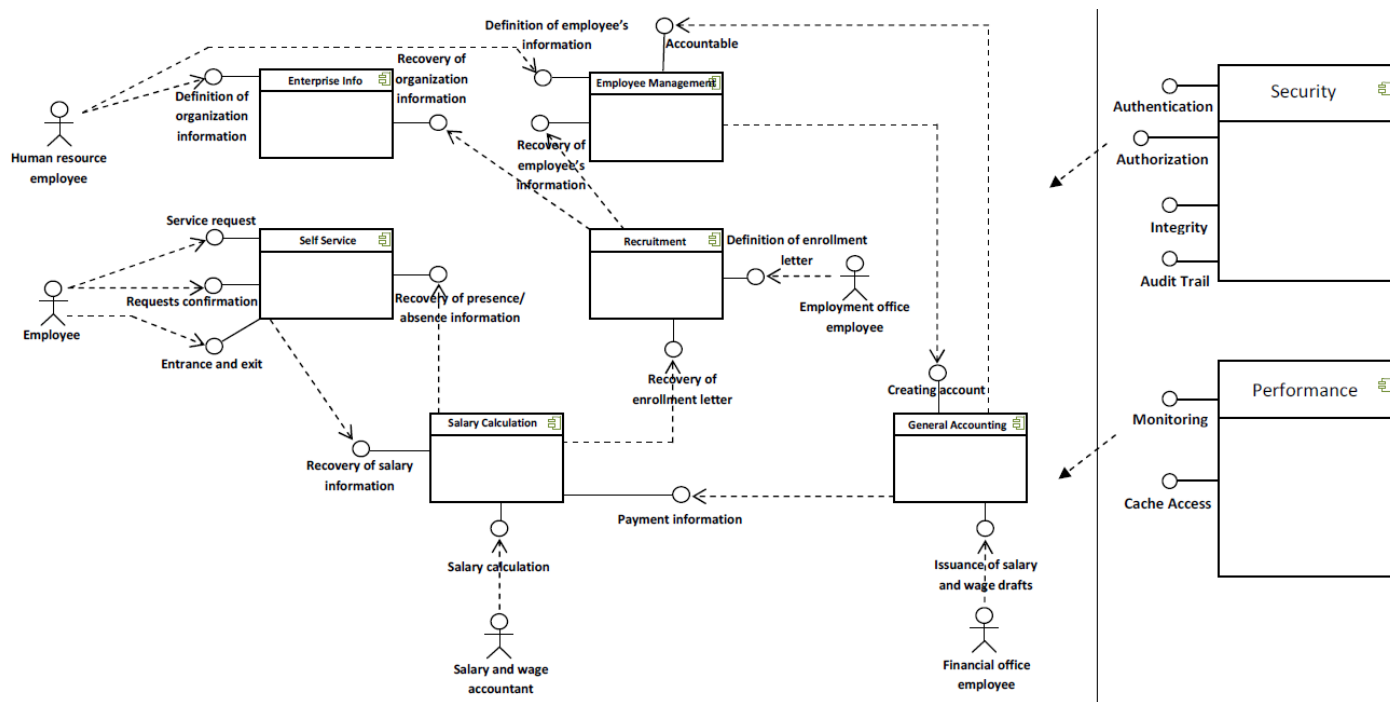

Figure 4. The proposed architecture

Table 2: A corrective maintenance scenario

Scenario No	S300
Scenario Type	Corrective maintenance scenario
Relevant Scenario	NFR-1 (Security)
Scenario Description	The has Permission On (username, action) method does not consider the user role in the permission scenario, while the user may have several roles in the system. Neglecting this may cause problem in the system. Because if the user has multiple roles, this method considers only his first role. Determination of the Right of access should be done separately for each user role.
Response	This method should be corrected as has Permission On (username, action and role).

5. Evaluation of the basic and proposed architectures

Two architecture design approaches of the case study were evaluated using ASAAM in terms of maintenance capability.

Four scenarios categories including scenarios for corrective maintenance, scenarios for perfective maintenance, scenarios for adaptive maintenance, and scenarios for preventive maintenance are defined in order to evaluate the

maintenance capability. A typical scenario is shown in Table 2.

In order to compare the basic and proposed architectures, each maintenance capability evaluation scenario was weighted considering the cost of the changes. The weight of each scenario is calculated using the following equation. The results are listed in Table 3. The average cost of each maintenance capability evaluation scenario was calculated. The results are listed in Table 4 as the costs of maintenance capability.

$$\text{Cost} = [(L * M * C) / T] * 100$$

Cost: the average cost of change

L: the number of affected layers of the architecture

M: the average number of the affected modules of each component in each layer

C: the number of affected components

T: total number of the subsystem modules

6. Conclusion and Summary

In the proposed approach, using the concept of aspect, the core functional concerns, operational non-functional concerns and controllable non-functional concerns were separated in the process of developing Web applications. The obtained architecture firstly fulfills the principle of separation of concerns better than before. Secondly, non-functional requirements with aspectual capability are clearly described. Therefore, it is expected the new architecture has higher maintenance capability than

the old architecture. The results of evaluation and testing performed on the case study as a web-based organizational application shows that the system maintenance capability will grow significantly with increasing adhesion of architectural components and removal of dependence of hundred system modulus to non-functional requirements as intersecting concerns through the use of aspects. Thus, according

to evaluation results and by comparing these two architectures, it can be concluded that the use of aspectual approach in modeling non-functional requirements in designing web applications result in increasing the maintenance capability of the application.

Table 3. Comparison of basic and aspect-oriented architectures in terms of maintenance costs

Scenario No	Average maintenance cost of each module in basic architecture	Average maintenance cost of each module in aspect-oriented architecture
S300	$[(4*4*6)/96]*100$	$[(4*1*1)/104]*100$
S301	$[(3*4*6)/96]*100$	$[(3*1*1)/104]*100$
S302	$[(1*2*6)/96]*100$	$[(1*1*1)/104]*100$
S303	$[(3*4*6)/96]*100$	$[(3*1*1)/104]*100$
S304	$[(3*4*6)/96]*100$	$[(3*1*1)/104]*100$

Table 4. Average cost of each maintenance capability scenarios categories

Maintenance activity	Average cost in basic architecture (scale: 100)	Average cost in aspect-oriented architecture (scale: 100)
Corrective maintenance	87.5	3.4
Perfective maintenance	43.7	1.9
Adaptive maintenance	87.5	3.4
Preventive maintenance	25	1

Corresponding Author:

Msc. Mohammad Pira
Department of IT
Payame Noor University
Tehran, Iran
E-mail: Mohammadpira408@yahoo.com

References

1. Roger S. Pressman. "Software Engineering: A Practitioner's Approach", Seventh Edition, McGraw-Hill Higher Education, 2010.
2. Otávio Augusto, Lazzarini Lemos. "A pointcut-based coverage analysis approach for aspect-oriented programs", Information Sciences, Volume 181, Issue 13, 1 July 2011.
3. Nenad Medvidovic, Eric M. Dashofy, "Moving architectural description from under the technology lamppost, Information and Software Technology, Vol. 49, No. 1, pp. 12-31, Jan 2007.
4. Chitchyan, Ruzanna, "Survey of Analysis and Design Approaches", AOSD-Europe., Deliverable D11, 2005.
5. Chiara Di Francescomarino, Paolo Tonella, "Crosscutting Concern Documentation by Visual Query of Business Processes", Lecture Notes in Business Information Processing, FBK-IRST, Trento, Italy, 2009.
6. Kandé, Mohamed Mancona. "A Concern-Oriented Approach to Software Architecture", PhD Thesis, Swiss Federal Institute of Technology (EPFL), Lausanne, Switzerland, 2003.
7. Ivar Jacobson, Pan-Wei NG. "Aspect-Oriented Software Development with Use Cases", Addison Wesley Professional, 2005.
8. Gregor Kiczales, John Lamping, "Aspect-Oriented Programming", In Proceedings of the European Conference on Object-Oriented Programming (ECOOP), 1997.
9. Gregor Kiczales, Erik Hilsdale, "An Overview of AspectJ", In Proceedings of the European Conference on Object-Oriented Programming (ECOOP), Pages 327-353, 2001.
10. Paul Clements, Rick Kazman, "Evaluating software architectures: methods and case studies", Addison-Wesley, 2006.
11. Jeff Garland, Richard Anthony, "Large-Scale Software Architecture, A Practical Guide using UML", John Wiley & Sons Ltd, 2003.
12. Gu-Beom Jeong, Guk-Boh Kim, "A Study on Software Architecture Evaluation", Springer Berlin / Heidelberg, 2006.
13. Bedir Tekinerdogan, "ASAAM: Aspectual Software Architecture Analysis Method", In Proceedings of the Fourth Working IEEE/IFIP Conference on Software Architecture (WICSA), 2004. pp. 5-14.

10/5/2012

Sufficient condition of a subclass of analytic functions defined by Hadamard product

Muhammad Arif¹, Irshaad Ahmed², Mohsan Raza² and Khalid Khan³

¹Department of Mathematics, Abdul Wali Khan University Mardan, Pakistan

²Department of Mathematics, GC University Faisalabad Pakistan

³Department of Science and Information Technology Govt; KPK, Peshawar, Pakistan

marifmaths@awkum.edu.pk (M. Arif), quantized84@yahoo.com (I. Ahmad), mohsan976@yahoo.com (M. Raza), khalidsa02@gmail.com (K. Khan)

Abstract: In the present article we obtain a sufficient condition for a function belongs to a class of analytic functions defined by convolution. The main result presented here includes a number of known consequences as special cases.

[Arif M, Ahmad I and Raza M. **Sufficient condition of a subclass of analytic functions defined by Hadamard product.** *Life Sci J* 2012;9(4):2487-2489] (ISSN:1097-8135). <http://www.lifesciencesite.com>. 367

Key Words: Analytic functions, spiral-like functions, convolution.

1. Introduction

Let the class of all functions

$$f(z) = z + a_{n+1}z^{n+1} + \dots$$

which are analytic in $E = \{z; |z| < 1\}$ be denoted by A_n and let $A_1 = A$.

A function $f(z) \in A_n$ is spiral-like of order β , if

$$\operatorname{Re} e^{i\lambda} \frac{zf'(z)}{f(z)} > \beta \cos \lambda, 0 \leq \beta < 1,$$

for all $z \in E$ and λ is real with $|\lambda| < \frac{\pi}{2}$. We denoted the class of all such spiral-like functions of order β by $S_\lambda^*(n, \beta)$. For $n = 1$ and $\beta = 0$, this class reduces to the well-known class of spiral-like functions which was introduced by Spacek [4] in 1933.

For any two analytic functions $f(z), g(z) \in A_n$, we define the convolution or Hadamard product by

$$(f * g)(z) = z + a_{n+1}z^{n+1} + \dots,$$

where $f(z)$ and $g(z)$ are given by

$$f(z) = z + a_{n+1}z^{n+1} + \dots, \text{ and } g(z) = z + a_{n+1}z^{n+1} + \dots.$$

Using the concept of convolution, we define a subclass $Q_\lambda(g, n, \beta)$ of analytic functions as follows:

A function $f(z) \in A_n$ belongs to the class $Q_\lambda(g, n, \beta)$, if

$$\operatorname{Re} e^{i\lambda} \frac{z(f * g)'(z)}{(f * g)(z)} > \beta \cos \lambda, 0 \leq \beta < 1,$$

for all $z \in E$ with $(f * g)(z) \neq 0$ and λ is real with $|\lambda| < \frac{\pi}{2}$. This class gives a transition from the class S^* of starlike functions to the class C of convex functions.

In this paper, we obtain a sufficient condition for a function to be in the class $Q_\lambda(g, n, \beta)$. To prove our main results, we need the following Lemma proved in [2].

Lemma. Let Ω be a set in the complex plane C and suppose that ϕ is a mapping from $C^2 \times E$ to C which satisfies $\phi(ix, y; z) \notin \Omega$ for $z \in E$, and for all real x, y such that $y \leq -n(1 + x^2)/2$. If $p(z) = 1 + c_n z^n + \dots$ is analytic in E and $\phi(p(z), zp'(z); z) \in \Omega$ for all $z \in E$, then $\operatorname{Re} p(z) > 0$.

Main results

In this section, we study some sufficient conditions for function belongs $Q_\lambda(g, n, \beta)$.

Theorem 2.1. If $f(z) \in A_n$, satisfies

$$\operatorname{Re} \left(e^{i\lambda} \frac{z(f * g)'(z)}{(f * g)(z)} \right) \left(\frac{\alpha z(f * g)''(z)}{(f * g)'(z)} + 1 \right) > \frac{M^2}{4L} + N, (z \in E)$$

where $0 \leq \alpha \leq 1, 0 \leq \beta < 1, \lambda$ is real with $|\lambda| < \frac{\pi}{2}$

and

$$L = \alpha(1 - \beta) \cos \lambda \left[\frac{n}{2} + (1 - \beta) \cos^2 \lambda \right]$$

$$M = -(1 - \beta)^2 \sin 2\lambda \cos \lambda$$

$$N = \alpha \cos \lambda (\beta^2 \cos^2 \lambda - \sin^2 \lambda) + \alpha \beta \sin \lambda \sin 2\lambda \alpha \cos^2 \lambda + \beta(1 - \alpha) \cos \lambda - \frac{n\alpha}{2}(1 - \beta).$$

Then $f(z) \in Q_\lambda(g, n, \beta)$.

Proof. Set

$$\frac{z(f * g)'(z)}{(f * g)(z)} = q(z) = \cos \lambda [(1 - \beta)p(z) + \beta] + i \sin \lambda. \quad (2.1)$$

Then $p(z)$ and $q(z)$ are analytic in E with $p(0) = 1$ and $q(0) = 1$.

Taking logarithmic differentiation of (2.1), we have

$$\frac{z(f * g)''(z)}{(f * g)'(z)} = \frac{zq'(z) + e^{-i\lambda}q^2(z) - q(z)}{q(z)},$$

and hence

$$\begin{aligned} & \left(e^{i\lambda} \frac{z(f * g)'(z)}{(f * g)(z)} \right) \left(\frac{\alpha z(f * g)''(z)}{(f * g)'(z)} + 1 \right) \\ &= Azp'(z) + Bp^2(z) + Cp(z) + D \\ &= \phi(p(z), zp'(z); z), \end{aligned}$$

with

$$\begin{aligned} A &= \alpha(1 - \beta) \cos \lambda, \\ B &= \alpha e^{-i\lambda} (1 - \beta)^2 \cos^2 \lambda, \\ C &= (1 - \beta) (2\alpha\beta e^{-i\lambda} \cos^2 \lambda + i\alpha e^{-i\lambda} \sin 2\lambda \\ &\quad + (1 - \alpha) \cos \lambda), \\ D &= \alpha e^{-i\lambda} (\beta^2 \cos^2 \lambda - \sin^2 \lambda + i\beta \sin 2\lambda \\ &\quad + (1 - \alpha)(\beta \cos \lambda + i \sin \lambda)). \end{aligned}$$

Now

$$\phi(r, s; t) = As + Br^2 + Cr + D.$$

For all real x and y satisfying $y \leq -n(1 + x^2)/2$, we have

$$\begin{aligned} & \phi(ix, y; z) = Ay + B(ix)^2 + C(ix) + D \\ &= Ay - Bx^2 + iCx + D \\ &\leq -\frac{(1 + x^2)nA}{2} - Bx^2 + iCx + D \\ &= -\left(\frac{nA}{2} + B\right)x^2 + iCx - \frac{nA}{2} + D \\ &= -\left[\frac{n}{2}\alpha(1 - \beta) \cos \lambda + \alpha e^{-i\lambda} (1 - \beta)^2 \cos^2 \lambda\right]x^2 \\ &\quad + i\left[(1 - \beta)(2\alpha\beta e^{-i\lambda} \cos^2 \lambda + i\alpha e^{-i\lambda} \sin 2\lambda + (1 - \alpha) \cos \lambda)\right]x \\ &\quad + \alpha e^{-i\lambda} (\beta^2 \cos^2 \lambda - \sin^2 \lambda + i\beta \sin 2\lambda) \\ &\quad + (1 - \alpha)(\beta \cos \lambda + i \sin \lambda). \end{aligned}$$

Now taking real part of both sides, we have

$$\begin{aligned} \text{Re } \phi(ix, y; z) &\leq -\alpha(1 - \beta) \cos \lambda \left[\frac{n}{2}\right. \\ &\quad \left.+ (1 - \beta) \cos^2 \lambda\right]x^2 \\ &\quad - [\alpha(1 - \beta)^2 \sin 2\lambda \cos \lambda]x \\ &\quad + \alpha \cos \lambda (\beta^2 \cos^2 \lambda - \sin^2 \lambda) \\ &\quad + \alpha\beta \sin \lambda \sin 2\lambda + \beta(1 - \alpha) \cos \lambda \\ &\quad - \frac{n\alpha}{2} (1 - \beta). \end{aligned}$$

Equivalently, we have

$$\begin{aligned} \text{Re } \phi(ix, y; z) &\leq -Lx^2 - Mx + N \\ &= -\left[\sqrt{L}x + \frac{M}{2\sqrt{L}}\right]^2 + \frac{M^2}{4L} + N \\ &< \frac{M^2}{4L} + N, \end{aligned}$$

where L, M and N are given in the hypothesis.

Let $\Omega = \left\{ \omega; \text{Re } \omega > \frac{M^2}{4L} + N \right\}$.

Then $\phi(p(z), zp'(z); z) \in \Omega$ and $\phi(ix, y; z) \notin \Omega, \forall$ real x and $y \leq -n(1 + x^2)/2, z \in E$. By an application of Lemma 1.1, we obtain the required result.

By taking $\beta = 0, n = 1, \lambda = 0$ and $g(z) = \frac{z}{1-z}$ in Theorem 2.1, we get the result proved in [1].

Corollary 2.2. If $f(z) \in A$, satisfies

$$\text{Re} \left\{ \frac{zf'(z)}{f(z)} \left(\alpha \frac{zf''(z)}{f'(z)} + 1 \right) \right\} > -\frac{\alpha}{2}, \quad z \in E, \alpha \geq 0,$$

then $f(z) \in S^*$.

If we take $\beta = \frac{\alpha}{2}, n = 1, \lambda = 0$ and $g(z) = \frac{z}{1-z}$ in Theorem 2.1, we obtain the following result proved in [1].

Corollary 2.3. If $f(z) \in A$, satisfies

$$\text{Re} \left\{ \frac{zf'(z)}{f(z)} \left(\alpha \frac{zf''(z)}{f'(z)} + 1 \right) \right\} > -\frac{\alpha^2}{4} (1 - \alpha),$$

then $f(z) \in S^* \left(\frac{\alpha}{2} \right)$.

If we take $\lambda = 0$ and $g(z) = \frac{z}{1-z}$ in Theorem 2.1, we obtain the result proved in [3].

Corollary 2.4. If $f(z) \in A_n$, satisfies

$$\begin{aligned} \text{Re} \left\{ \frac{zf'(z)}{f(z)} \left(\alpha \frac{zf''(z)}{f'(z)} + 1 \right) \right\} \\ > \alpha\beta \left[\beta + \frac{n}{2} - 1 \right] + \left[\beta - \frac{\alpha n}{2} \right], \end{aligned}$$

$0 \leq \alpha, \beta < 1$, then $f(z) \in S_n^*(\beta)$.

Theorem 2.5. Let $\alpha \geq 0, 0 \leq \beta < 1$ and λ is real with $|\lambda| < \frac{\pi}{2}$. If $f(z) \in A_n$ satisfies

$$\begin{aligned} \text{Re} \left\{ e^{i\lambda} \frac{(f * g)(z)}{z} \left(\alpha \frac{z(f * g)'(z)}{(f * g)(z)} + 1 - \alpha \right) \right\} \\ > \left[\beta - \frac{n\alpha}{2} (1 - \beta) \right] \cos \lambda, \end{aligned}$$

then

$$\text{Re } e^{i\lambda} \frac{(f * g)(z)}{z} > \beta \cos \lambda.$$

Proof. Consider

$$e^{i\lambda} \frac{(f * g)(z)}{z} = [(1 - \beta)p(z) + \beta] \cos \lambda + i \sin \lambda.$$

Taking logarithmic differentiation, we get

$$\begin{aligned} \alpha \frac{z(f * g)'(z)}{(f * g)(z)} + 1 - \alpha \\ = \frac{[\alpha(1 - \beta) \cos \lambda] zp'(z)}{[(1 - \beta)p(z) + \beta] \cos \lambda + i \sin \lambda} + 1 \end{aligned}$$

So

$$e^{i\lambda} \frac{(f * g)(z)}{z} \left(\alpha \frac{z(f * g)'(z)}{(f * g)(z)} + 1 - \alpha \right) \\ = [\alpha(1 - \beta)\cos\lambda]zp'(z) \\ + [(1 - \beta)\cos\lambda]p(z) \\ + (\beta\cos\lambda + i\sin\lambda). \\ = \phi(p(z), zp'(z); z).$$

For all real x and y satisfying $y \leq -n(1 + x^2)/2$, we have

$$\phi(ix, y; z) = [\alpha(1 - \beta)\cos\lambda]y + [(1 - \beta)\cos\lambda](ix) \\ + (\beta\cos\lambda + i\sin\lambda).$$

Taking real part on both sides, we have

$$\operatorname{Re} \phi(ix, y; z) = [\alpha(1 - \beta)\cos\lambda]y + \beta\cos\lambda \\ \leq -\frac{1}{2}n(1 + x^2)\alpha(1 - \beta)\cos\lambda + \beta\cos\lambda \\ \leq \beta\cos\lambda - \frac{n\alpha(1 - \beta)\cos\lambda}{2}.$$

Let us take

Let $\Omega = \left\{ \omega; \operatorname{Re} \omega > \left[\beta - \frac{n\alpha}{2}(1 - \beta) \right] \cos\lambda \right\}$. Then $\phi(p(z), zp'(z); z) \in \Omega$ and $\phi(ix, y; z) \notin \Omega, \forall$ real x and $y \leq -n(1 + x^2)/2, z \in E$. By an application of Lemma 1.1, we obtain the required result.

References

1. Li JL and Owa S. Sufficient conditions for starlikeness, Indian J. Pure Appl. Math., 2002; 33: 313-318.
2. Miller SS and Mocanu PT. Differential subordination and inequalities in the complex plane, J. Differ. Equations, 1987; 67: 199-211.
3. Ravichandran V, selvaraj C and Rajalakshmi R. Sufficient conditions for starlike functions of order alpha, J. Ineq. Pure Appl. Math., 2002; 3 (5): 1-6.
4. Spacek, L Prispěvek k teorii funkei prostych, Čapopis Pest. Mat. Fys., 1933; 62: 12-19.

10/13/2012

Prevalence and Determinants of Low Birth Weight in Abha City, Ksa

¹Faten M. R. Ismaeil H and ²Al Musa H. M

¹Public Health and Community Medicine Department, College of Medicine, Assiut University-Egypt.

²Family Medicine Department, King Khalid University, College of Medicine, Abha, Kingdom of Saudi Arabia.

Abstract: Low birth weight babies have been defined by W.H.O as weight at birth of less than 2.5 kg. It contributes substantially to neonatal, infant and childhood mortality as well as morbidity. Across the world neonatal mortality is 20 times more likely for low birth weight babies compared to heavier babies (> 2.5 kg). The World Health Organization has estimated that annually 24 million LBW infants are born in developing countries. As the prevalence of LBW infants is around 5% in many industrialized countries, it changes between 5-30% in underdeveloped or developing countries. One of the goals of the 1990 World Summit for Children was to reduce the prevalence of low birth weight to less than 10% by the year 2000. However, this remains a formidable challenge to-date. Objectives: To estimate the prevalence of low birth weight among babies registered in the primary health care centers in Abha city and to identify the factors that determines Low Birth Weight among these babies. Subjects and methods This study followed a cross-sectional design. It was conducted in Abha City, which is the capital of Aseer Region in Saudi Arabia. Results: 18.8% of the studied babies had LBW. The present study showed that birth weight was significantly associated with level of utilization of antenatal care. Maternal age is an important risk factor related to birth weight of the neonate. Mothers less than 20 years of age had increased proportion of LBW babies. LBW was more common in female babies as compared to male babies. working mothers are at increased risk of having LBW infants, Mothers had previous abortion, preeclampsia, hypertension or anemia had LBW babies. Conclusion: It is concluded from this study that young maternal age, maternal work, poor antenatal care, maternal anemia, and pregnancy induced medical ailments have strong association with low birth weight. To overcome these problems, the mother and child health care services should receive special attention and mothers must be encouraged to attend the PCCCs regularly for antenatal care.

[Faten M. R. Ismaeil, and Hasssan Al Mosa. **Prevalence and Determinants of Low Birth Weight in Abha City. KSA.** *Life Sci J* 2012;9(4):2490-2495]. (ISSN: 1097-8135). <http://www.lifesciencesite.com>. 368

Keywords: Low birth weight, Determinants, prevalence.

1. Introduction

Children's health is to a great extent determined by factors that operate in utero, well before they are born. ⁽¹⁾ Birth weight (BW) is the most important determinant of perinatal, neonatal, and post-neonatal outcomes. ⁽²⁾ Poor growth during the intrauterine period increases the risks of perinatal and infant mortality and morbidity throughout life ⁽³⁾. Low birth weight (LBW) is responsible for 60% of the infant mortality in the first year of life and it carries a 40-fold increase in the risk of neonatal mortality during the first month ⁽⁴⁾. Low birth weight is defined as a birth weight of a live born infant of less than 2,500 g, regardless of gestational age and is associated with a range of both short- and long-term adverse consequences. ⁽⁵⁾

Infants born LBW are at risk to develop acute diarrhea or to be hospitalized for diarrhoeal episodes at a rate almost two to four times greater than their normal birth weight counterparts ⁽⁶⁾. Infants who are LBW risk contracting pneumonia or acute lower respiratory infections (ALRI) at a rate almost twice that of infants with normal birth weight; and more than three times greater if their weight is less than 2000 g. ⁽⁷⁾ LBW is also implicated as a contributor to

impaired immune function which may be sustained throughout childhood ⁽⁸⁾.

Low birth weight is a risk factor for malnutrition, growth retardation, failure to thrive and cognitive impairment. Low birth weight is also a risk factor for atherosclerosis, renal disease, non-insulin dependent diabetes mellitus, asthma, hypertension, obesity, psychological stress and hepatoblastoma. ⁽⁹⁾

Although about one-half of all LBW infants in industrialized countries are born preterm (<37 wk gestation), most LBW infants in developing countries are born at term and are affected by intrauterine growth restriction that may begin early in pregnancy ⁽¹⁰⁾.

The World Health Organization has estimated that annually 24 million LBW infants are born in developing countries. As the prevalence of LBW infants is around 5% in many industrialized countries, it changes between 5-30% in underdeveloped or developing countries ⁽¹¹⁾

According to current available data from 111 countries, Yemen has the highest percentage of LBW (32%); it is lowest in Albania, which also is a developing country. It is 5% in Denmark and 6% in Italy. The figure stands at 19% for Pakistan, 22% for

Sri Lanka and 30% for India and Bangladesh. This is in sharp contrast to neighboring China (6%) and Iran (7%).(12).

Causes of IUGR are complex and multiple, Growth will be retarded *in utero* if the placenta is abnormally small or blocked causing insufficient nutrients to reach the fetus. The maternal environment is the most important determinant of birth weight, and factors that prevent normal circulation across the placenta cause poor nutrient and oxygen supply to the foetus, restricting growth. These factors may include maternal undernutrition, anaemia, and acute and chronic infections (such as sexually transmitted diseases and urinary tract infections). Also associated with IUGR are maternal disorders such as renal diseases and hypertension. Cigarette smoking and pre-eclampsia cause the highest relative risks for IUGR in industrialized countries, while alcohol and drug use may also restrict foetal growth (13).

Low socio-economic status is the underlying cause of low birth weight. Other causes include maternal diseases like antepartum hemorrhage, cervical incompetence; adolescent pregnancies; short birth intervals; intrauterine infections; congenital malformations. Also it has been documented that there is increased risk of low birth weight among young mothers (<20 years) as compared to mothers above 20 years (14).

Multiple gestations are high risk pregnancies, which may be complicated by pre-maturity, low birth weight infants, preeclampsia, anemia, postpartum hemorrhage, intrauterine growth restriction, neonatal morbidity and high perinatal, neonatal and infant mortality. The rate of multiple gestation pregnancies has grown exponentially over the last few decades and is responsible for the steady increase in the rate of low birth weight infants. As a group, infants of multiple gestation pregnancies have higher mortality and morbidity than singleton pregnancies. The increase in adverse outcomes is related to the increased risk of preterm delivery and low birth weight, and not to the multiple gestation itself (15).

Gebremariam (16) found that younger maternal age, maternal short stature, late antenatal visits and complicated pregnancies were significantly associated with low birth weight. Less than 4 antenatal visits, coffee or tea intake during pregnancy, and repeated abortions as risk factors of LBW. Pre-term labor, premature rupture of membrane and close birth spacing, as risk factors of LBW (17).

One of the goals of the 1990 World Summit for Children was to reduce the prevalence of low birth weight to less than 10% by the year 2000. However, this remains a formidable challenge to-date. It is therefore encouraging that the international public

health community has begun to increase its attention toward these four million infants who die each year and the many more that survive with a diminished quality of life. Low birth weight is a reasonable well-defined problem caused by factors that are potentially modifiable and the costs of preventing them are well within reach, even in poor countries (18).

Objectives:

- 1- To estimate the prevalence of low birth weight among babies registered in the primary health care centers in Abha city.
- 2- To identify the factors that determines Low Birth Weight among these babies.

2.Subjects and methods:

This study followed a cross-sectional design. It was conducted in Abha City, which is the capital of Aseer Region in Saudi Arabia.

In this study all babies who were delivered alive and registered in the primary health care centers in Abha city during one year period from 1st January 2010 to 31th December 2010 were considered.

The data was obtained from the Case Records of Mothers of Babies registered in the primary health care centers. Records with insufficient Information were excluded.

The neonates divided into two groups according to the birth weights recorded in the health records. All LBW neonates were classified as the case group, while those whose birth weight exceeded 2,500 g served as the control group. In total, 3280 mothers and babies were included. Preterm and multiple babies were excluded.

Data for both groups of infants were listed in a special questionnaire that included maternal and delivery data, as well as data about the newborn. Variables such as age, body mass index (BMI), mother's body weight and height, presence of serious disease(s) before delivery, antenatal care, complications during pregnancy, smoking and working status and educational level of the mother, route of delivery, gender of the neonate and were carefully retrieved from the medical records of the mother and neonate. Births that occurred at < 37 weeks were classified as preterm. Neonatal birth weight < 2,500 g was classified as LBW.

Data was analyzed using the Statistical Package for the Social Sciences version 20 (SPSS,20). Frequencies and percentages were computed to present the categorical response variables like sex of baby, antenatal booking status, age, parity, working status, inter pregnancy interval and anemia. Chi-square test was applied to compare the categorical response variables between case and control groups. A *p*-value < 0.05 was considered to be statistically significant.

3. Results:

As table (1) shows, only 14.1% of births were born by cesarian section. About half of babies mothers (47.3%) attended the primary health care centers three times or more for antenatal care. Most of mothers were in the age group 20-35 years. The minimum age was 16 years and the maximum age was 45 years with the mean age was 27.67 years. About one third (27.3%) of the studied mothers were primigravida. About half of the studied babies (49.3%) had birth interval more than three years. As regard the birth order, about one third (27.4%) were the fifth child or more. More than half of the babies (51.2%) were males. More than three fourths (77.6%) of the studied mothers were house wives.

Table(1): Description of the study population

Characteristics	No.	%
Birth weight		
Normal	2664	81.2
LBW	616	18.8
Route of delivery		
Normal	2816	85.9
Cesarean section	464	14.1
No. of antenatal visits		
Nil	616	18.8
Inadequate (1-2)	1112	33.9
Adequate (3 or more)	1552	47.3
Maternal age		
Less than 20 years	88	2.7
20 -35 years	2696	82.2
More than 35 years	496	15.1
Range (years)	16-45	
Mean±SD (years)	27.67±5.840	
Birth interval (years)		
Primigravida	896	27.3
< 1	360	11.0
1-3	408	12.4
> 3	1616	49.3
Birth order		
1 st	896	27.3
2 nd - 4 th	1488	45.3
≥ 5 th	896	27.4
Fetal sex		
Male	1680	51.2
Female	1600	48.8
Mother work		
House wife	2544	77.6
Working	736	22.4
Total	3280	100

Table (2) shows that more than one third (36.8%) of the mothers had previous abortion and 27.3% of them had previous low birth weight. Only 3.2% of the mothers had preeclampsia and 2.0% of

them complained of DM during pregnancy. Few of the mothers had hypertension, bleeding and urinary tract infection during pregnancy (3.4, 4.1 and 4.6%) respectively. More than one third of the mothers (33.4%) had anemia during pregnancy and about one fifth of them (20.7%) exposed to second hand smoking.

Table (2): Factors influencing the birth weight

Characteristics	No.	%
Previous Abortion		
Yes	1208	36.8
No	2072	63.2
previous LBW		
Yes	896	27.3
No	2384	72.7
Preeclampsia		
Yes	104	3.2
No	3176	96.8
Diabetes Mellitus		
Yes	64	2.0
No	3216	98.0
Hypertension		
Yes	112	3.4
No	3168	96.6
Bleeding		
Yes	136	4.1
No	3144	95.9
Urinary tract Infections		
Yes	152	4.6
No	3128	95.4
Anemia		
Yes	1096	33.4
No	2184	66.6
Second hand smoking		
Yes	680	20.7
No	2600	79.3
Total	3280	100

Table (3) Shows that 18.8% of the studied babies had LBW. Less than half of low birth weight babies (45.5%) born by cesarian section, while only 6.9% of normal birth weight born by cesarian section. The difference was statistically significant ($P=0.000$).

The difference between LBW and NBW as regard of number of antenatal visits was statistically significant ($p=0.027$). 11.7% of low birth weight babies were born to mothers less than 20 years of age while only 0.6% of the normal birth children born to mothers less than 20 years. The difference was statistically significant ($P=0.000$).

54.5% of babies with birth interval less than one year were low birth weight while only 0.9% of NBW had birth interval less than one year, the difference

was statistically significant ($P=.000$). As regard the birth order there was statistically insignificant difference between LBW and NBW babies ($P=.073$). More than half of babies with LBW (58.4%) their mothers were working compared to only 14.1% of NBW their mothers were working, the difference was statistically significant ($P=.000$).

Table (3): Risk factors for low birth weight

Characteristics	No (%)		P-value
	LBW	NBW	
Route of delivery Cesarean section	280(45.5%)	184(6.9%)	.000
No. of antenatal visits			
Nil	208(33.8%)	408(15.3%)	.027
Inadequate (1-2)	248(40.2%)	864(32.4%)	
Adequate (3 or more)	160(26%)	1392(52.3)	
Maternal age			
less than 20 years	72(11.7%)	16(0.6%)	.000
20 -35 years	432(70.1%)	2264(85.0%)	
more than 35 years	112(18.2%)	384(14.4%)	
Birth interval (years)			
< 1	336(54.5%)	24(0.9%)	.000
1-3	80(13.0%)	328(12.3%)	
> 3	8(1.3%)	1608(60.4%)	
Birth order			
1 st	192(31.2%)	704(26.4%)	.073
2 nd - 4 th	248(40.3%)	1240(46.5%)	
≥ 5 rd	176(28.5%)	720(27.1%)	
fetal sex			
male	264(42.9%)	1416(53.2%)	.032
female	352(57.1%)	1248(46.8%)	
Mother work			
House wife	256(41.6%)	2288(85.9%)	.000
Working	360(58.4%)	376(14.1%)	

Table (4) shows that 42.9% of LBW babies mothers had previous abortion while 35.4% of NBW babies mothers had previous abortion, the difference was statistically significant ($P=.000$). About half of the mothers of LBW babies (45.5%) had previous LBW compared to 23.1% of NBW mothers, the difference was statistically significant ($P=.032$). 13.0% of mothers of LBW babies had preeclampsia during pregnancy while only 0.9% of NBW mothers had preeclampsia, the difference was statistically significant ($P=.000$). The difference between LBW and NBW as regard DM was statistically insignificant ($P=.069$). 15.6% of mothers of LBW babies had hypertension during pregnancy compared to only 0.6% of mothers of NBW babies, the difference was statistically significant ($P=.000$). 19.5% of mothers of LBW babies had bleeding during pregnancy compared to only 0.6% of mothers of NBW babies and the difference was statistically significant ($P=.000$). As regard urinary tract infections, 23.4% of mothers of LBW babies complained of UTI compared to only 0.3% of mothers of NBW babies and the

difference was statistically significant ($P=.000$). About two thirds (64.9%) of mothers of LBW babies had anemia during pregnancy while 26.1% of mothers of NBW babies had anemia, the difference was statistically significant ($P=.000$).

Table(4): cont. Risk factors for low birth weight			
Characteristics	No.(%)		P.Value
	LBW	NBW	
Previous Abortion			.000
Yes	264(42.9%)	944(35.4%)	
No	325(57.1%)	1720(64.6%)	
previous LBW			.032
Yes	280(45.5%)	616(23.1%)	
No	336(54.5%)	2048(76.9%)	
Preeclampsia			.000
Yes	80(13.0%)	24(0.9%)	
No	536(87.0%)	2640(99.1%)	
Diabetes Mellitus			.069
Yes	32(5.2%)	32(1.2%)	
No	584(94.8%)	2632(98.8%)	
Hypertension			.000
Yes	96(15.6%)	16(0.6%)	
No	520(84.4%)	2684(99.4%)	
Bleeding			.000
Yes	120(19.5%)	16(0.6%)	
No	496(80.5%)	2648(99.4%)	
Urinary tract Infections			.000
Yes	144(23.4%)	8(0.3%)	
No	472(76.6%)	2656(99.7%)	
Anemia			.000
Yes	400(64.9%)	696(26.1%)	
No	216(35.1%)	1968(73.9%)	

4. Discussion:

In our study, 18.8% of the studied babies had LBW. A study in Riyadh, 2004 shows that the prevalence of LBW in all deliveries at KCUH was 11.3% (19). Other studies in Taif region, KSA showed that the prevalence of LBW was 13.6% (20)

The rate of caesarean section was much higher in the LBW births (45.5%) than in

the NBW births (6.9%). Delivery by caesarean section was seen more frequently in LBW infants and this indicated once more that LBW infants were more prone to morbidity and mortality. This was consistent with the results of a study in Turkey which shows that the caesarian section route was higher in LBW than NBW babies (21).

The present study showed that birth weight was significantly associated with level of utilization of antenatal care ($p<0.027$). 33.8% of mothers who did not receive proper antenatal care delivered LBW babies while only 15.3% who did not receive any antenatal care delivered LBW. This result was consistent with an Indian study which shows that birth weight was significantly associated with level of utilization of antenatal care (22).

Maternal age is an important risk factor related to birth weight of the neonate. The relationship between maternal age and birth weight was significant when compared for mothers below and above 35 years of age. Mothers less than 20 years of age had increased proportion of LBW babies. This result supports previous studies mentioning teenage pregnancy as a risk factor(23).

54.5% of babies with birth interval less than one year were of low birth weight while only 0.9% of NBW had birth interval less than one year, the difference was statistically significant, these results are in agree with the results of a study in Iran (24). In our study, there was a difference between LBW and NBW babies as regard the birth order(31.4 & 26.2%) respectively, but this difference was statistically insignificant ($P=0.073$). Other studies showed that the birth order play a significant role in LBW (23- 25).

LBW was more common in female babies as compared to male babies (57.1% vs 42.9%) and this was consistent with another study in Pakistan which shows that

LBW was more common among female babies (26) but the same sex distribution have been seen in many studies.(27,28).

Our study also demonstrated that working mothers are at increased risk of having LBW infants, a finding that was also reported in Nobile *et al.*'s study (29). However, Dickute *et al.* reported that maternal unemployment during pregnancy significantly increases the risk of bearing infants with LBW.(30).

Our study showed that LBW was more common in babies whose mothers had previous abortion, this result was agreed by Golestan *et al.* study(24), But another study demonstrated that no significant difference between previous abortion and LBW (31). The present study also demonstrated that LBW was common in babies whose mothers had previous low birth weight babies, this is agreed by

Joshi *et al* study in India (22).

The present study also demonstrated that maternal preeclampsia significantly increases the risk of LBW in infants, which was in agreement with findings from other studies.(32,33).

Hypertension causes blood vessel stenosis in some pregnant women, which may result in neonates with LBW. The adverse effect of hypertension on birth weight was also observed in two other studies.(24,32) The blood pressure of pregnant women should be monitored during pregnancy, for their own health and the health of their foetus.

Our study showed that the difference between LBW and NBW babies as regard DM was statistically insignificant and this was also demonstrated by other

studies(24,31). Another study showed that DM is a risk factor for LBW

The present study demonstrated that mothers complained of bleeding during pregnancy give birth to LBW babies, Also, Maternal anemia has been related to Low birth weight, These results were agreed by Yadav *et al* who found a significant difference between LBW and NBW babies as regard ante partum hemorrhage (31). Mothers with Urinary tract infection were more risky to give birth of LBW babies, This is agreed by other study (24).

Conclusion:

It is concluded from this study that young maternal age, maternal work, poor antenatal care, maternal anemia, and pregnancy induced medical ailments have strong association with low birth weight. To overcome these problems, the mothers must be encouraged to attend the PCCC's regularly for antenatal care.

Corresponding author

Faten M. R. Ismaeil¹

Public Health and Community Medicine Department, Assiut University-Egypt

References:

- 1- Wilcox AJ, Skaeven R. Birth weight and perinatal mortality: The effect of gestational age. *Am J Public Health* 1992;82:378-83.
- 2- Maloni JA, Cohen AW, Kane JH. Prescription of activity restriction to treat high risk pregnancies. *Journal of Women's Health* 1998;7(3):351-8.
- 3- Sprague AE. The evolution of bed rest as a clinical intervention. *Journal of Obstetric, Gynecologic, and Neonatal Nursing* 2004;33(5):542-9.
- 4- Hanedan S. SSK. Bakırköy Dogumevi, Kadın ve Çocuk Hastalıkları Eğitim Hastanesi, Uzmanlık Tezi. Modifiye Wigglesworth sınıflaması ile perinatal mortalitenin 21659 dogumda değerlendirilmesi. 2000.
- 5- World Health Organization. International Classification of Diseases, Ninth revision, Vol. 1 Geneva, World Health Organization, 1987.
- 6- Victora CG, Barros FC, Kirkwood BR, Vaughan JP (1990). Pneumonia, diarrhea, and growth in the first 4 y of life: a longitudinal study of 5914 urban Brazilian children. *American Journal of Clinical Nutrition* 52:391-396.
- 7- Fonseca W, Kirkwood BR, Victoria CG, Fuchs SR, Flores JA, Misago C (1996) Risk factors for childhood pneumonia among the urban poor in Fortaleza, Brazil: a case-control study. *Bulletin of the World Health Organization* 74:199-208.
- 8- Chandra RK (1999) Nutrition and immunology: from the clinic to cellular biology and back

- again. *Proceedings of the Nutrition Society* 58(3):681-683
- 9- Godfrey KM, Barker DL. Fetal nutrition and adult disease. *Am J of Clin Nutr* 2000; 71: 1344-52.
 - 10- Villar J, Belizan JM. The relative contribution of prematurity and fetal growth retardation to low birth weight in developing and developed societies. *Am J Obstet Gynecol* 1982;143:793-8.
 - 11- Basso O, Olsen J, Christensen K. Low birth weight and prematurity in relation to paternal factors: a study of recurrence. *Int Epidemiology*. 1999;28:695-700.
 - 12- UNICEF. *The state of World's Children 2005 for UNICEF*. Oxford: Oxford University Press 2005: 104-45.
 - 13- Henriksen T (1999) Foetal nutrition, foetal growth restriction and health later in life. *Acta Paediatrica* 429S:4-8.
 - 14- Simiyu DE. Morbidity and mortality of low birth weight infants in the newborn unit of Kenyatta National Hospital, Nairobi. *East Afr Med J*. 2004 Jul; 81(7):367-74.
 - 15- Kilsztajn S, Rossbach A, do Carmo MS, Sugahara GT. Prenatal care, low birth weight and prematurity in Sao Paulo State, Brazil, 2000] *Rev Saude Publica*. 2003 Jun; 37(3):303-10
 - 16- Gebremariam A. Factors predisposing to low birth weight in Jimma Hospital south western Ethiopia. *East Afr Med J* 2005; 82 (11): 554-8.
 - 17- Rahman S, Talat A. An analytic study of risk factors for frequency of small for gestational age (SGA) and appropriate for gestational age (AGA) low birth weight babies in Peshawar Pakistan. *J Postgrad Med Inst* 2007; 21 (1): 3-9.
 - 18- Tema, T. Prevalence and determinants of low birth weight in Jima zone, Southwest Ethiopia. *East African Medical Journal* 2006, 83, 366-371.
 - 19- Sameer Abdullah, The Prevalence and Relationship between Periodontal Disease and Pre-term Low Birth Weight Infants at King Khalid University Hospital in Riyadh, Saudi Arabia. *The Journal of Contemporary Dental Practice* 2004, 6 (2): 212-217.
 - 20- Khalid A. Madani, Hassan A. Nasrat, Low Birth Weight in Taif Region, Saudi Arabia. *Eastern Mediterranean Health Journal* 1995, 1, 47-54.
 - 21- Emel Altuncu, Sultan Kavuncuoğlu, The Incidence Of Low Birth Weight In 5000 Liveborn Infants And The Etiology Of Fetal Risk Factors. *Marmara Medical Journal* 2006;19(2);46-51.
 - 22- Joshi H S, Srivastava P C, Risk Factors for Low Birth Weight (LBW) Babies and its Medico-Legal Significance. *J Indian Acad Forensic Med* 2007, 32(3).971-976.
 - 23- Fariha Anjum, Tahir Javed, Maternal Risk Factors Associated With Low Birth Weight: A Case Control Study. *Annals* 2011, 17. (3) 223-227.
 - 24- Golestan M, Akhavan Karbasi S, Fallah R, Prevalence and risk factors for low birth weight in Yazd, Iran. *Singapore Med J* 2011; 52(10): 730-733.
 - 25- Louangpradith Viengsakhone^{1,2}, Yoshitoku Yoshida¹, Harun-Or-Rashid¹. Factors Affecting Low Birth Weight At Four Central Hospitals In Vientiane, Lao Pdr Nagoya J. *Med. Sci.* 2010, 72. 51 ~ 58.
 - 26- Afshan Bhatti, Shabnam Naz, Najia Bhatti. Maternal Risk Factors Associated With Low Birth Weight Babies. *Medical Channel* 2010. 16,(2):241-250.
 - 27- Aziz M, Jabbar A, Wadood AA, Khattak MI. Birth weight of term, appropriate for gestational age neonates in Pakistan. *The PROFESSIONAL* 2003; 10(3): 1-5.
 - 28- Som S, Pal M. Effects of socioeconomic and Biological variables on birth weight in Madhya Pradesh, India. *Mal J Nutr* 2004; 10(2): 1
 - 29- Nobile CG, Raffaele G, Altomare C, Pavia M. Influence of maternal and social factors as predictors of low birth weight in Italy. *BMC Public Health* 2007; 7:192.
 - 30- Dickute J, Padaiga Z, Grabauskas V. Maternal socioeconomic factors and the risk of low birth weight in Lithuania. *Medicina (Kaunas)* 2004; 40:475-82.
 - 31- Yadav DK, Chaudhary U, Shrestha N³. Risk Factors Associated with Low Birth Weight. *J Nepal Health Res Counc* 2011 Oct;9(19):159-64.
 - 32- Roudbari M, Yaghmaei M, Soheili M. Prevalence and risk factors of low-birth-weight infants in Zahedan, Islamic Republic of Iran. *East Mediterr Health J* 2007; 13:838-45
 - 33- Nekatibeb G, G/Mariam A. Analysis of birth weight in Metu Karl hospital: South West Ethiopia. *Ethiop Med J* 2007; 45:195- 202. J.E. SIZA. Risk factors associated with low birth.

The Study of the Relationship between the Place of Residence Quality and the Feeling of Social Security in Kashan

¹Melahat Ahmadi, ¹Batoole Abedi, ¹Sanam Taghizadeh and ²Maryam Rezghi

¹Department of Urban Design, Science and Research Branch, Islamic Azad University, Zanjan, Iran

²Department of Urban Design, Qazvin Branch, Islamic Azad University, Qazvin, Iran

Abstract: Formation of suburbia is an obvious exposure of urban poverty and forms spontaneously without construction permit and official scheme for civil construction, it is developed by gathering of low income groups and live in low levels of quality and quantity compared to other areas and regions of city and named as non-official residential, spontaneous dwelling and slums, in this areas, due to this fact that humanism is vanished, social deviations grow rapidly and crimes such as burglary, addiction, smuggling, prostitution would extend. Furthermore, development of grounds for activities and extension in narco above and family disorders in suburbia is constructive factor to include social insecurity. This paper aims to assess degrees of social insecurity feeling and dwelling quality in Kashan city. To conduct this, we imply measurement method and 225 residence of Kashan selected by proper cluster sample and by articulated questionnaires data gathered. Validity of consistency of this study determined by Cronbach alpha for social security construction. Measure of social security feeling due to 12 separate aspects (Life risk, financial, semantic, ethical, cultural, economical, civil, emotional, feelings, occupation, legal and chastity) has been evaluated. According to this study results, there is not any difference in social security feelings and value in assessed regions.

[Ahmadi M, Abedi B, Taghizadeh S, Rezghi, M. **The Study of the Relationship between the Place of Residence Quality and the Feeling of Social Security in Kashan.** *Life Sci J* 2012;9(4):2496-2501] (ISSN:1097-8135). <http://www.lifesciencesite.com>. 369

Key words: Security feeling % Urban ecology % Physical security % Kashan city

1. Introduction

According to UN report, today most of world's population feels insecurity due to everyday life than a global disaster. Job security, health security, environmental, crimes and discriminations in consuming opportunities which negate discriminations in consuming opportunities which negate personal security are all anxieties of each individual in the world and providing insecurities or in other words negating personal and social security (Akhavan Kazemi, 2007).

One of the important, complicated and new contexts in modern world in among many political, social and economic issues is subject and concept security (Akhavan Kazemi, 2009). Security is regarded as basic requirement and necessity of individual and society and lack or perturbation in that would have reflex and consequences at the level of perilous and worrisome (Esmaili Zadeh, 2008) whereas citizens need to achieve high ranks of growth and this should be in secure and calmness which due to grow in rates of crimes and social disorders the formation of wrongdoing and insecurity in society lead to high levels of panic in society (Torabi & Godarzi, 2006). Thus, social security is more than other issues of importance for individuals necessary. In consequence to suburbia phenomenon, a lot of problems contribute in city life. Although these problems may not result directly of above mentioned phenomenon, in fact they are indirect effects which slum dwelling regions create or

enhance them. Suburbia involvement in nonofficial and fake occupations, unauthorized constructions, providing numerous problems for city management, disability of municipalities to maintain civic indices and undesirable cultural, social, economic and sometimes political effects of these areas on total civic system are destructive and undesirable effects of suburbia lives (Sherafati poor, 2006). Addressing suburbia living not only is necessity from humanism and ethical aspects but also is compliance to social benefits and consistency of communities and national development.

Social security as an index of social welfare could be aim of development and included in a network of cause and effect should be examined and evaluated to achieve security as a goal of development. On the other hand this is a tool for obtaining development. Consistent development has diversified aspects and simulations and harmonic growth of these dimensions leads to consistent development. And is a major characteristic for that. Social development includes mutual relation with social welfare and social security context. Security means to be safe regarding harm, theater harm phobia or fear (Hosseini, 2007). Therefore, attending security and feeling secure extents separate to various factors related to economy, social such as economical and social rank of individuals and quality of dwelling area in city, are required to be assessed scientifically and accurately.

Table 1. History of studies and researches into related issues of suburbia

Iranian History studies	International History studies
Fatemeh Karimi (2003), Massoud Sharifi Daryaz (2005), Mohammad Zahedi Assl (2006), Akhavan Kazemi (2007), Hossain Hosseini (2007)	Freks, G (2004), Michael Pacione (2003), Schneider, B. (2003), Mumtaz Babar (2001), Macedo, J (2000)

2. Review of Literature

The first who used “Suburbia” and “man of Suburbia” was Robert. A. Park. He described these conceptual terms in his paper “Human migration and man of Suburbia” (Khoshfar, 2005). In this section, which are related to Suburbia issue divided into national and foreign ones introduced in following (Table 1).

Naja deputy of social affairs and Ispa center of public opinion (Rahebiee, 2004) conducted a study named “Assessment of social Security feeling regarding views of Tehran citizens”. In theoretical criteria of this study, Morton, Welfares, Hors and others concepts are used. Results of this study show that measure of security feeling in location for majority of respondents is low (Zahedi Asl, 2006). Respondent don't feel secure about others in their interactions with social environment and 40% evaluate their security in their residential quarter high, while 60% respond that security in Tehran is low and very low. Most of respondents their evaluate police function in providing and maintaining security to be suitable. In the section of two variable results of study to be suitable, it is revealed that there are positive and meaningful relation between people's income and social security, but in general it may concluded that social security of Tehran's citizens is low. In summary and regarding this study, one may express that although this measurement derived from a work frame and scientific method which are acceptable, researchers had not consider Copenhagen forum theories such as Bouzan theorem and Weaver idea and this lead to negation of cultural and characteristic dimensions which account as major aspects of this variable (Sharifi Daryaz, 2005). Naja (2004) conducted idea evaluation in order to study police functional performance named “assessment of security feeling measure amongst suburbia of Tehran super city resolved by districts” to find out this community idea, Results of this research demonstrated that age, sex, marital, status, educations and income affect individuals' security feeling (Karimi, 2003). Esmaili Zadeh (2008) in his study suggested that to increase social security in supersites, the only way is local society's development (Esmaeil Zadeh, 2008).

Taylor *et al.*, (1985) conducted a study about relation between residents features and their expressions of physical disorders, they tried to assess (examine) structural and individual relations between

fear and environmental signs different with the social-economical levels. In middle class districts, the signals are corresponds to social disorder and civil corruptions, thus related to crime and insecurity. They concluded that in quarters which residents social-economy rank is high enough to create self confidence and is not low to generate pessimism, state of physical environment regarding to be bad or good affect drastically scope of people in quarter. Smith in other to complete this implication added that, respond to this question of why fear of crime and insecurity is very high in some areas and in other limited to wordiness only should be investigate d in civic environment features (A social atmosphere saturated by buildings) where fear is experienced. The main hypothesis is, these signals are not fearful spontaneously, they only excite fear in people who equalize civil disorder with crimes (Naderi et al., 2003). The rather successful results of some functional schemes to enhance security feeling level obtained by manipulating mentioned signals and provided indirect authentications for this approach claims. For example, Tin et al reported that improving lights of avenues has meaningful role in decreasing fear and insecurity feeling (Freks, 2004).

3. Materials and Methods

3.1. Theoretical Considerations

In this section, separate from numerous theories about feeling secure and various social effects on this, ecology approach that consider the relation of insecurity feeling measure and dwelling location as well as social economy rank in specified way is pointed out. Some observation in this approach try demonstrating relation between dwelling location and insecurity feeling: as an example it might be pointed that signs of physical disorders in quarter and social control weakness may bring risk of public consideration as insecure and dangerous area (Schneider, 2003). Disorder may regard as picture of social and physical environment suggesting, first. There is no control and concern, second values and incitement of other shareholder of observed community are affected and deviated. Due to investigation such as Ferraro, civil distressed means that social standards are at low level and in sequence imply the sign that values and disciplines which are ethically accepted are subsided. By analyzing data from national measurements, Ferraro found that civil distressed may provide ecological information which form people assumption of being victims of crimes, then this consideration can affect fear of crime and insecurity within society (Bullock & Susie, 2004). In this approach attempts are oriented to establish relation between individuals' feeling and ground variables such as citizenship, social life and civil distress.

Other ecological ideas are as following:

residents of super cities are reported more fear than small towns and rural areas and people who live in central districts of city (Mumtaz, 2001). Some experts, in addition, found meaningful correction between community size or city size and insecure feeling. Others suggest that that fear of insecurity in urban environment is due to population diversity, social atmosphere, grow and change dynamics in these environments, hence insecure feeling as they suggested is equal to urban "Alien" phobia or cultural and future phobia. In brief, a set of environmental marks accompany with insecure feeling are as following:

- Deem light of quarter in night
- Vandalism (Anarchy)
- Number of residents in quarter
- Suitable locations to hide criminals
- Disorderly and unsuitable buildings
- Acoustic pollution
- Quarters people considerations
- Deserted and abandoned streets
- Locations included abandoned areas: Park, Parking lots, or factor in vicinity of residential
- Ordinary disturbing and disorder behavior in quarter
- Existing ruined places and suitable locations for criminals to hide
- Existing clues of addicts such as left syringe or blacken walls due to lightening fire
- Gathering of wanderer and fussy youngsters who use bad language
- Fights and quarrels in quarter specially when mostly reported

All above mentioned issues may be categorized in two major groups: Social signals and Physical signals. Social signals includes disturbing behavior, acoustic pollution and scope of quarter people and physical signals include elements such as vandalism, ruined places or wandering dogs (Pacione, 2003).

3.2. Design

In this study survey method is used, while for developing study conception criteria and reviewing previous researches, library (Documentations) method is exploited, finally this study due to characteristic, time m scale and spread measure is applicable, intersected and extended, respectively, statistical community includes all citizens of Kashan city during October and November 2011 and by using Koukaran formula sample volume determined to be 225 individuals. In

this study method of proper clusters sampling is used (pps), whereas first, Kashan Municipality districts considered as main clusters and then avenues and round about in each distinct made blocks of cluster, at last phase, respondents are studied randomly. Tool of this study was questionnaires; these are used in final phase after receiving credit and consistency at primary phase of study, when used in order to gathering data.

4. Results

In this section, analytical and descriptive finding in brief and through tables and graphs are demonstrated. As the following table, security feeling in this study constituted of 11.76 in average and cultural security feeling has lowest with average of 5.73, average of total index due to lowest and highest value 23 and 170.

Physical security feeling is examined as one of aspects of social security. Following table 2 shows abundance distribution and percentage responses based on this item (range from not "at all" to "very much" in 6 levels). Study results suggest that people in our sample group don't feel secure in activities such as trafficking with non-official taxi and by taxi in the night as alone.

Feeling is evaluated in this study as a dimension and percentage responses based on this item (range from "not at all" to "very much" in 6 levels) is demonstrated. Average obtained above (Table 3) middle and it suggests Kashan citizens feel secure in chastity regards. Thus it concludes that in chastity aspect people highly feel secure.

Among 12 aspects of security in this study, detailed data of occupation and chastity are provided in above (Tables 4). Regarding analytical finding of this paper, we used Anva or Variance analysis. One of the independent variables was residential area of city which divided in three areas called uptown, middle town and down town. Considering levels of meaningfulness F test (equal to 0.99) it is detected that there are no difference city district of living due to social security feeling.

Results are shown in above table suggest that differences are between respondents exists due to economy-social states of them are not observed, on the other hand by considering meaningfulness level of 0.027 for social security feeling as well as their dimensions, it is noted that economy-social base has meaningful positive correction only with physical security aspect of social security and there is not any meaningful relation with other dimensions, it means that people of higher economy-social base feel more secure in term of physical aspects of than others.

Table 2. Abundance distribution of social security feeling aspects physical security feeling as an aspect of security

Aspects	Average	Measure deviation	Minimum score	Maximum score
Emotional security feeling	10.59	3.77	0	20
sensatical security feeling	9.21	2.72	0	15
Legal security feeling	9.45	3.32	0	20
Chastity security feeling	11.76	4.11	0	20
Cultural security feeling	5.73	2.77	0	16
Indicial security feeling	7.52	3.42	0	17
Mental security feeling	7.74	3.98	0	18
Ethical security feeling	8.07	3.50	0	20
Economic security feeling	8.13	3.51	0	17
Financial security feeling	8.76	3.68	0	18
Occupation security feeling	8.10	2.96	0	18
Physical security feeling	6.77	4.32	0	18
Social security feeling	105.01	24.20	0	170

Table 3. Abundance distribution of questions regarding physical security, chastity security

statements	Options		Average		Very low		Low		Medium		High		Very high		0 to 5
	percent	abundance	Percent	Abundance	percent	abundance	percent	abundance	Percent	abundance	Percent	abundance	Percent	abundance	
Walking alone in a empty route	19.9	49	26.8	66	10.2	25	25.6	63	13	22	4.5	11	1.98		
Travel within official taxies in the night	45.5	112	22.8	56	13	32	13.4	33	4.1	10	1.2	3	1.11		
Travel lonely in a night in taxi	45.5	112	22.8	56	12.2	30	24.4	60	11.4	28	2.4	6	1.78		

Table 4. Abundance distribution of questio

Statements	Options		Average		Very low		Low		Medium		High		Very high		(0 to 5)
	percent	abundance	percent	Abundance	percent	Abundance	percent	Abundance	percent	abundance	Percent	abundance	Percent	abundance	
Aggression to chastity in quarter	2.8	7	14.6	36	18.3	45	26	64	22.8	56	15.4	38	2.98		
Aggression to chastity in city	7.7	16	27.6	68	22	54	22	54	14.2	35	6.5	16	2.27		
Aggression to chastity by relations and friend	2	5	4.1	10	13	32	13.8	34	26	64	41.1	101	3.81		
Aggression to chastity during travel in day or night	2.4	6	15.6	36	26.3	72	23.6	58	18.3	45	10.6	26	2.71		

Table 5. Output of variance analysis in comparison of social security feeling in up, middle, down city located areas

Meaning	Squares sum	degree of freedom	Squares average	FF	Meaning
Intergroup Variance	1897.52	2	947.26	1.626	0.199
Within group Variance	141571.47	243	582.60		
Total variance	143465.98	245			

To evaluate social-state and measure of social security Pierson correction coefficient is used.

Table 6. Correction matrix of economy-social base and different aspects of secur

Aspects	Financial security feeling	Economic security feeling	Ethical security feeling	Mental security feeling	Indicial security feeling	Cultural security feeling	Chastity security feeling	Legal security feeling	Sensatical security feeling	Emotional security feeling	Physical security feeling	Financial security feeling	Occupation security feeling	Social security feeling
Social-economic basic	Pierson coefficient 0.190*	-0.026	-0.006	0.054	-0.074	0.061	-0.074	-0.057	0.019	-0.016	-0.021	0.081	0.026	0.027
Meaningfulness level		0.003	0.920	0.396	0.246	0.337	0.246	0.376	0.766	0.804	0.741	0.205	0.683	0.676

5. Conclusion and Discussion

Recognition of each phenomenon is related to our knowledge of its historical process, for suburbia there are reported notions about sleeping and residing in ruined places and cemeteries, living in slums and deserted areas (Pal and Kumar, 2005).

Suburbia phenomenon in Iran begins from date of accelerated development and expanding of cities; formation of suburbia is one of the scopes of poverty attached to urbanization which is grown by non-permitted civil constructions and activities which conducted informal an unofficially arisen from gathering low income people at very low level of life quality and quantitative aspects (Macedo, 2000). On the other hand, security feeling as a psychological and social element is affected by direct and indirect experiences of people in face of different social conditions in order to achieve healthy life and consistent social relations. From a total of 225 respondents in our study 52.4% of male samples and 47.6% of females included, in term of income 38% were at range of 401 to 600 thousand Toman. 5% were lower than 200 thousand and 2% more than one million toman. In term of economy-social status, 76% in middle rank, 19% of low and 5% of high rank. 64% of participants live in middle class areas, 25% in high class and 11% live in low class areas, about occupation; 45% had middle level jobs, 26% low and 18% very low level jobs, 10% involved in high level and only half percent involved in very high levels jobs.

However, results of economy-social base relation with social security feeling demonstrated that this is not confirmed. Although in compliance to ecological approach, people who live in low level areas would have had more insecure feeling, but evaluation of this point shows that quality of residential area has not any effort measures of insecure / social feelings and this critical matter is consistence with study results of their findings (Sclarée et al., 2005). Physical environment of bad or well has drastic effect on people's vision of their quarter, then on their social security feelings. Because of richness in culture of this city which mostly is rooted in religious learnings, there are significant different areas of city (Smart, 2003).

Finally, the fact that by upgrading human needs even living requirements all are functions of society so This is a multi dimensional phenomenon and study on this consisted of diversified factors of economy, political and social life, but most of the experts believe that measure of society feeling in society is as important as security itself, because individuals react the same as their understanding of level of security, therefore security feeling is a key variable in this ground (Margaret, 2006).

Corresponding Author

Melahat Ahmadi

Department of Urban Design, Science and Research Branch, Islamic Azad University, Zanjan, Iran

References

1. Akhavan Kazemi, Bahram, 2007. Security and aspects in Qara, *Islamic study Seas and release*, 75: 11-39.
2. Akhavan Kazemi, Bahram, 2009. Security in Farabi and Mohaghegh Toosi, *Islamic State Seas and release*, 14th year, 2: 110-89.
3. Esmaeil Zadeh, Hassan, 2008. Local communities, strategy of social security growth in super cities, *Social security second release 4th year*, 14: 11-37.
4. Torabi, Yousef and Ayat Goodarzi, 2006. Values and Social security, series of articles on Social security seminar, *Social deputy NAJA*, 1: 164-189.
5. Sherafati poor, Javid, 2006. Cruelty news in publications survey and its effect on society, *Social Security Studies 2nd year*, 6: 22-34.
6. Hosseini Hossain, 2007. Security feeling, conceptual look into on research finding, *Security sea sand release 5th year*, 4: 7-51.
7. Khoshfar, Gholamreza, 2005. People contribution in developing, holding and expanding social security in cities centers of Mazandaran province, *Series of articles on social security*, 3: 134-145.
8. Rahebiee, Ali, 2004. *National Security Studies Ministry of foreign affairs*. Political studies office, Tehran, Ministry of foreign affairs print and publication center.
9. Zahedi Assl, Mohammad, 2006. Social Psychological Security in Social working view, Series of articles on seminar of Psychology role, Social aid and consultancy in maintaining and developing social-psychological security, Social deputy of Naja, pp: 49-84.
10. Sharifi Daryaz, Massoud, 2005. A survey in over taking and effective factors on it by emphasizing Security feeling, Master degree thesis, Literature and human sciences faculty Shahid Beheshti University, Tehran.
11. Karimi, Fatemeh, 2003. Evaluating Suburbia problems by emphasizing on cultural-social aspects (Isfahan, Darak and Arznan districts) Master degree thesis, Isfahan University, Isfahan, pp: 17-18.
12. Esmaeil Zadeh, 2008. Survey on citizens' security feeling Order of social deputy Naja. Survey on security feeling of suburbia community in Tehran Super city resolved by districts, Tehran, Social and guidance deputy Naja.

13. Naderi, Hamdollah, Mohammad Ali Jahed and Mohindokht Shirzadeh, 2010. Survey on social security and social capital (Case study of Ardabili) social security sea sand release, 21: 59-89.
14. Freks, G., 2004. Risk and Globalization: the Globalization of Risk, *society for international development*, 4: 32-41.
15. Schneider, B., 2003. Beyond Fear: Thinking Sensibility about Security in an Uncertain World, Library of Congress Cataloging-in-publication Data: USA.
16. Bullock, B.S. and J. Susie, 2004. An analysis of Technology use and quality of life in a rural west Texas community, university of Texas.
17. Mumtaz Babar, 2001. Why cities need slums. *Habitat Debate*, 7(3): 15.
18. Pacione, Michael, 2003. Urban environmental quality and human wellbeing-a social geographical perspective, *Landscape and Urban Planning*, 65: 19-30.
19. Pal, A.K. and U.C. Kumar, 2005. Quality of life concept for the evaluation of societal development of rural community in west bangal, India, *Rural Development*.
20. Macedo, J., 2000. Land use Policies and Urbanization of Formal Settlement. Planning Imitative for Environmental Protection Areas in Curitiba, Brazil, Dissertation PH.D, Advisor: Stroh, Robert C. University of Florida: United States.
21. Sclarée, Elliot, D., et al., 2005. The 21st century health challenge of slums and cities, *The lancet*, 365. London.
22. Smart, Alan, 2003. Impeded self-help: toleration and the proscription of housing consolidation in Hong Kong's squatter areas. *Habitat International*, 27: 205-225.
23. Margaret S., 2006. A longitudinal investigation of satisfaction with personal and environmental quality of life in an informal South African housing settlement, Doorknob, Soweto, *Habitat International*, 30: 175-189.

10/10/2012

The consideration of nerve pressures arising from work and its role in reducing the organization productivity in Fars province Red Crescent Society

¹Mehrzad Sarfarazi (Corresponding Author), ²Sholeh-Sadat Ehteshami

¹Instructor and PhD Candidate, Faculty of Management and Accounting, Qazvin Branch, Islamic Azad University, Qazvin, Iran

²Researcher of Iranian National Center for Globalization Studies, Tehran, Iran

Abstract: Stress is a physical or emotional depression arises from real or imaginary matters and problems. Stress can cause numerous damages to the individuals and organizations. It is the people's reflection against the threatening environment characteristics. The aim of current research is to consider the association between the influences of nerve pressures arising from work (work stress) on reducing the organization productivity in Fars province Red Crescent society. The research method is measuring –descriptive. The research statistical samples include all the managers of the 3 branches of master, middle and operational, as well as the employees of Fars province Red Crescent society which are 463 people of the cities of Firooz –abad, Lamerd, Shiraz, Fasa, Neyriz, Jahrom, Gerash, Khonj, Lar, Evaz, Darab, and Kazeroun. 106 samples were selected at random through cluster sampling method. The questionnaires were distributed among the samples and 94 of them were returned to the researcher. The research questionnaire contains 30 questions which are regulated according to research hypotheses by the researcher. In order to measure the validity of the questionnaire, the validity of the contents is used. The Alpha cronbach method is used to estimate the measurement tool reliance of this research. The data statistical processing is done within the NINITAB and SPSS software environments. The research results regarding the main hypotheses of the study, have shown that Fars province Red Crescent employees believe that nerve pressures are not considered as factors to reduce the productivity. However, they believe that they may sustain a loss or damage in their working environments which is one of the causes of their organization productivity reduction. Regarding the first derivative hypothesis of the research, it can be concluded that the more important the employees careers, the less stress. The results of the second derivative hypothesis of the research show that the large volume of tasks and works lead to more stress in employees. The research results also support the third derivative hypothesis and show that the more conflicts in roles of the employees, the more stress they will experience. However, the fourth hypothesis is not supported. Therefore, the conflicts of employees personal relationships with other colleagues and managers do not lead to stress.

[Mehrzad Sarfarazi, Sholeh-Sadat Ehteshami. **The consideration of nerve pressures arising from work and its role in reducing the organization productivity in Fars province Red Crescent Society..** *Life Sci J* 2012;9(4):2502-2510] (ISSN:1097-8135). <http://www.lifesciencesite.com>. 370

Keywords:

Nerve pressures arising from work –nerve pressure consequences –effective factors in making stress productivity –organizational productivity.

Introduction:

Due to the studies, the majority of employees of organizations have considered those symptoms which show their depression or stress. According to one of the conducted researches, reducing those problems and matters which lead to the employees' stress at their working environments, is considered as one the responsibilities of the organization management. Thus, deliberating the amount of stress arising from working environment matters and problems can make the management aware of the employees mental and physical health. So, in case stress negative symptoms are seen, necessary decisions will be made by the management to diminish the stress and to guide the organizational environment toward its improved level that leads to the highest point of employees productivities. Since, in today industrial world, the people are highly engaged in life and work concerns,

the intensive social activities of these societies, Particularly in civil lives and in organizations, negate the individuals peace and calm and involve them in mental and nerve pressures at times.

The first step to leave these mental pressures, is to recognize the nerve pressures making factors. Then, to decrease the amount of stress, it is necessary to do some changes, both in life and working environments, such as reducing the social commitments, changing the life path and place movement. Similarly, if mental pressures happen continuously, other approaches can also be used to dominate the stress. In this research, we will seek the answer to this question that whether or not there are any relationships between nerve pressures arising from work and reducing the organization productivity. We will also seek the answers to other questions such as :

Do the nerve pressures resulted from work (stress) lead to mental tension?

Do the nerve pressures resulted from work (stress)lead to reduction of employees performances ?

Do the nerve pressures resulted from work (stress) influence the accessibility of an organization to its predetermined goods ?

Are the managers organization able to control and diminish the nerve pressures resulted from work (stress)?

Measuring the nerve pressure at the organization:

The most recognized consequences of nerve pressures relate to companies and organizations, and among all of them statistics related to the absences comes at first. This statistics demonstrates the employees daily absences percents in their work environments.

However, it cannot be concluded that the company with the highest amount of absences undoubtedly suffers the employees nerve pressures more than other companies (for instance in some particular industrial companies happenings such as employees injuries or damages, are the main causes of their absences. In fact, sometimes some of the companies suffer the presence of their employees; the presence of unqualified and tired employees who like the absents, do not have any benefits and advantages to the companies. The individuals with nerve pressures prefer not to stay at homes. They want to be at their work place (Montazeri, 1383, p14).

Diagram 1: the research conceptual model

- A valuable job
- Reducing the productivity
- The high volume of work
- Nerve pressure arising from work
- The role conflict
- The contrast in employees relationship
- The Research Objectives

The main goal: Discovering the relationship between nerve pressures arising from work (stress) and the reduction of productivity.

The derivative goal:

1:Discovering the relationship between the volume of work nerve pressures arising from work (job stress).

2:Discovering the relationship between the role ambiguity and amount of nerve pressures arising from work.

3:Discovering the relationship between the contrast of employees personal and the amount of nerve pressures arising from work.

4:Discovering the relationship between personal symptoms of stress and employees job securities.

The research hypotheses and the main hypothesis:

There is a significant relationship between nerve pressures arising from work (stress) and reduction of organization productivity.

The derivative hypothesis:

1:It seems that the more valuable job leads to less stress.

2-It seems that the high volume of work causes stress among employees.

3-It seems that the conflict in roles lead to stress among employees.

4-It seems that contrast of employees personal relationships with other colleagues and managers lead to stress.

The research methodology:

The research method is a collection of rules, tools, reliable and systematic ways for considering the facts, discovering the ambiguities, and the accessibility to problem solutions (Ezzati.1376,p20).

The measuring research selects the small and large groups and considers the psychological and sociological mutual relations by studying those selected samples (Kerlinjer,Fred, Ann,1374,p213).

The sample society includes assumptive or real members to which the research results are transferred.(Delavar,1384,p167). the sample society is a collection of all the elements sharing one or more common features (Hooman,1373,p147) due to the research goals. The method of this research is measuring –descriptive.

The statistical samples of the research include the managers of three branches (master, middle and operational).

The sampling and sample volume determination method:

The sample volume is the whole elements of a sample. The sample size depends on the nature of a society and the purpose under the consideration. (Sarukhani. 1377, p157).

The sampling procedure of this research is cluster method. In order to determine the necessary sample, first of all among Fars provinces Red Crescent groups including Shiraz, Firooz Abad, Lamerd, Fasa, Neiriz, Jahrom, Grash, Khonj, Lar, Evaz, Darab, and Kazeroon, samples were selected at random and by referring to every one of these groups the statistics related to the number of the employees were discovered.The whole statistical samples contain 115 people including the managers of all ranks as well as the employees. According to the below formula, 106 people were chosen as sample volume and about 106 questionnaire were distributed among them. At last, 94 questionnaires were returned to the researcher.

$$n = \frac{ntS^2}{nd + t^2S^2} = \frac{364 \times 1/96^2 \times /29^2}{436 \times /5^2 + 1/96^2 \times /29^2} = 106$$

Table 1 shows the statistical society and necessary sample volume:

THE Data collection and measurement tool:

The questionnaire is identified as a most common method of data collection (Delavar,1384,p120)

The measurement tool of this research is the researcher-made questionnaire. This questionnaire contains 30 inquiries which are designed based on Likert spectrum, that measures the research hypotheses. First of all, the answerer must reply to public questions such as gender, age, education level, work and experience background and...

The validity of the measurement tool:

The concept of validity answers this question that to what extent the measurement tool, measures the intended Feature. Without knowing the validity of the measurement tool, one can not rely on the related Findings (Sarmad and Friends, 1379,p170).

In order to measure the validity of the questionnaire of this research, the validity of the contents is used. There Fore, the questionnaire inquiries were regulated by the researcher and other staff, through studying the related scientific literature and theories. Then, they were offered to the experts and after necessary reformations, profiting by experts opinions and the confirmation of the validity of the contents, the questionnaire was supported and made ready in order to be distributed among statistical samples.

The reliance of measurement tool.

The reliance of measurement tool means that to what extent the measurement tool leads to the equal results within the different conditions.

The reliability index range is usually from zero (The lack of communication)to +1 (full communication) (Sarfarazi,1382,p113). To calculate the reliability index of a measurement tool, the Cronbach Alfa method has been used. This method is used for calculating the inside coordination of measurement tool such as the questionnaires or tests which measures the various features. In this type of measurement, the response to each question can be diverse numerical amounts. In order to calculate the Cronbach Alfa index, the grade variances of every questionnaire inquiries subcategories (or sub-test) as well as the general variance, must be computed first. Then, the Alfa index amount should be figured out through this formula:

Ra=

In which:

J=The number of sub categories of the test questionnaire inquires.

S21=the variance of the M sub –test.

S2=The variance of the general test.(Sarmad and friends,1378,p169)

The research findings:

The tables of frequency distribution:

The consideration of related questions about the main hypothesis of the research.

The main question of the research: The nerve pressures arising from work (stress), reduce the organizational productivity.

Table 2 shows the consideration of questions related to the main hypothesis of the research.

According to the Findings of the above table, the average grade of the 1st question is equal to 3/25m, the second question: 3/27, the third question: 2/69, the fourth question: 3/61, the fifth question: 2/8.

The highest collective percent of agree and fully agree with 56/4, related to the fifth question (I think in my working environment, there is a possibility to be damaged while doing the tasks): In contrast, the Lowest collective percent of agree and fully agree with 21/3, related to The fourth question (I do not like my job, but I can not take a risk and change my working path).

The average grade of the answers have been fluctuated from 2/69 to 3/61 which indicates the amount of answerers agreement with the effect of nerve pressures arising from work (stress), on reduction of organizational productivity.

Table 3: The comparison of the average grade of nerve pressure index with standard grade.

$$H_0 = M \geq 3$$

$$H_1 = M < 3$$

H_0 = The nerve pressures arising from work (stress) do not lead to the reduction of organizational productivity.

H_1 = The nerve pressures arising from work (stress) lead to organizational productivity.

The average grade o the answerers were 3/25, with the standard deviation of 0/967.

With respect to the fact that the observed t at the level of $p < 0/01$, has not been significant, the zero presumption is not rejected. In other words the nerve pressures arising from work (stress), do not lead to an organizational productivity reduction. The employees believe that nerve pressures are not considered as productivity reduction factors.

The examination of questions related to the research first derivative hypothesis

The first derivative question of the research:

It seems that, the more important one's job is, the less stress she/he may have.

Table 4 shows the examination of questions related to the research first derivative hypothesis

Due to the above findings, the average grade of question 6 is : 2/29, question 7: 2/10, question 8: 1/52, question 9: 2/15, question 10: 3/01. The highest percent alternatives of "agree" and "fully agree", with 93/6, relate to the eighth question (If I do a job which I am really interested in, I can perform the tasks better), and the lowest percent of collective alternatives of "Fully agree" and "agree", with 49, relate to the tenth question (I quit doing any entertainments because I am fully engaged in the job).

The average grade of the answers have been, fluctuated between 9/52 to 3/01 which indicates the agreement amounts of answerers with the influence of job importance on stress reduction:

Table 5 shows the comparison of the average grade of job importance improvement index, with the standard grade.

$$H_0 = M \geq 3$$

$$H_1 = M < 3$$

H_0 = In case, there is a more important job, the stress will not be reduced.

H_1 = The more important work, the less stress.

The average grades of the answerers have been 2/20, with the standard deviation of 0/629.

As the observed t at the level of $p < 0/01$ has been significant, the zero presumption is rejected.

The examination of questions related to the research second derivative hypothesis:

The second derivative question:

It seems that the high volume of work lead to employees stress.

Table 6 shows the examination of questions related to the research second derivative hypothesis:

According to the above findings, The average grade of question 11 is equal to 2/56, the twelfth question: 2/83, the thirteenth question: 2/89, the fourteenth question: 2/02, the fifteenth question: 2/81, and the sixteenth question: 2/90.

The highest collective percent of the alternatives "Fully agree" and "agree" with 64/9, relate to the question 11 (I don't feel inner calmness if there is much to do at work place), and the lowest collective percent of "Fully agree" and "agree", relate to the 14th and 16th questions (I don't agree to take the tasks to home However, I have to do it at times) and (I feel I am not able to look after my household members Due to the high volume of work to be done).

The answerers average grades have been fluctuated from 2/02 to 2/90 which indicates the agreement of the answers with the influence of high volume of work on the increase of stress.

Table 7 shows the comparison of the average grade of the high volume of work index with the standard grade.

$$H_0 = M \geq 3$$

$$H_1 = M < 3$$

H_0 = The high volume of work do not lead to the employees stress.

H_1 = The high volume of work lead to the employees stress.

The average grade of the answerers have been 2/67 with the standard deviation of 0/629. Due to the fact that the observed t in the level of $p < 0/01$ has been significant, the zero presumption is rejected. In other words, the high volume of work leads to the enhancement of employees ' stress.

The examination of questions related to the research third derivative hypothesis:

The third derivative hypothesis: It seems that, the role conflict leads to stress among the employees.

Table 8 shows the examination of questions related to the research third derivative hypothesis

Table 9 shows the examination of question related to research fourth derivative hypothesis.

According to the above findings, the average grade of question 23 is equal to 2/37, question 24: 2/94, question 25: 3/67, question 26: 2/95, question 27: 2/72, question 28: 3/56, question 29: 2/46 and question 30: 3/85. The highest collective percent of alternatives "Fully agree" and "agree" with 69/9, relate to the twenty – third question (I like to be at a busy environment and in communication with other people), and the lowest collective percent of the alternatives "Fully agree" and "agree" with 17, relate to the thirtieth question (The people do not accept my request and make me disappointed).

The average grade of the answers has been fluctuated from 2/37 to 3/58 which shows the agreement of the answerers with the influence of employees personal relationships with other colleagues and managers on the stress.

Table 10 shows the comparison of the grade average of contrast index in personal relationships, with the standard grade.

$$H_0 = M \geq 3$$

$$H_1 = M < 3$$

H_0 = The contrast of employees personal relationships with other colleagues and managers does not lead to the stress.

H_1 = The contrast of employees leads to the stress.

The grade average of the answerers has been 3/063 with the standard deviation of 0/897. Due to the fact that the observed t at the level of $p < 0/01$ has not been significant, the zero presumption is not rejected.

In other words,

The contrast in personal relationships with other colleagues and managers does not lead to stress.

The independent T test:

Table 11 shows the comparison of average grades of both female and male answerers regarding the research indices.

Due to the fact that the observed T at the level of $p < 0/05$ has not been significant, there is no difference between the opinions of female and male answers. Similarly, from female and male's points of view, the influence of nerve pressure on the reduction of productivity, the influence of high volume of work on stress, the influence of the conflict on stress and influence of contrast in employees job – related relationships on stress, are all the same. According to male's opinions, the highest influence is on the effect of nerve pressures on productivity reduction and then, on the influence of contrast in employees job – related relationships on stress, The influence of the high volume of work on stress, the influence of the role conflict on stress and the influence of job importance on productivity reduction, respectively. However, women think that the highest influence is on the effect of nerve pressures on productivity reduction and then, on the influence of the contrast in employees job-related relationships on stress, the influence of role conflict on stress, the influence of high volume of work on stress and the influence of job importance on stress reduction, respectively.

Conclusion and suggestions:

1: The analysis of the main question of the research:

The main question of the research:

The nerve pressures arising from work (stress) Lead to the productivity reduction.

The findings analysis related to the above hypothesis indicate that the grade average of nerve pressures influence has been 3/25 with the standard deviation of 0/967.

Due to the fact that observed T at the level of $p < 01$ and ($p = 0/000$) has not been significant, the employees believe that the nerve pressures are not the Factors of productivity reduction.

The analysis of those indices related to nerve pressures has shown that the highest influence of nerve pressure on organizational productivity reduction, relate to the fifth question (I think there is a possibility to be damaged while working at my job place) with 56/4. In other words, most of the Red Crescent employees believe that, at their job environment, there is a possibility to be damaged and this is one of the factors of organizational productivity reduction.

According to the research Findings, it can be concluded that, working environments must be secured from being damaged

The examination of the research first derivative question:

It seems that, the more important job, the less stress.

The analysis of the findings related to the research first and derivative question shows that, the grade average of the influence of job importance on the reduction of stress has been 2/20, with the standard deviation of 0/624. Due to the fact that the observed T at the level of $p < 01$ and ($p = 0/000$) has been significant, with the probability of 0/99 it can be concluded that in case there is an important job, the stress will be reduced. In other words, the Red crescent employees believed, due to the employees self – confidence and credit. The analysis of the indices related to the influence of job importance on the reduction of stress shows that the highest effect of job importance on the stress reduction relates to the eighth question (In a job which I am really interested, I can do my duties better if I play my role correctly) with 93/6. In other words, the most employees of the Red Crescent believe that in case they became employed at their favorite job, they will do their duties better. According to the findings of this research, it can be concluded that by making a correct culture among the employees, i.e by showing the importance of their jobs and taking their jobs into consideration, the stress of employees can be reduced. The comparison of the females and males opinions indicate that the influence of job importance on the reduction of stress does not differ among men and women. ($p = 0/093$).

3: The examination of the research second derivative question:

It seems that the high volume of work leads to the stress among the employees.

The analysis of the findings related to the research second derivative question has shown that the grade average of the influence of the high volume of job on the stress has been 2/67 with the standard deviation of 0/629. Due to the fact that the observed T at the level of $p < 01$ and ($p = 0/000$) has been

significant, it can be concluded 99% that: the more volume of work, the more stress.

The analysis of the indices related to the influence of high volume of work on the stress indicates that the highest effect of high volume of work on stress relates to the eleventh question (I will not feel deep calm in case there is much to do) with 64/9.

In other words, most of the employees of the Red Crescent believe that if there are high volume of work, they will not feel deep calm. It can be concluded that the high volume work of the individuals must be reduced by employing new working forces, and there fore the stress will be reduced too (p=0/109)

The comparison of males and females opinions show that the influence of job importance on the reduction of stress does not differ among men and women (p=0/093).

4: The examination of the research third derivative question:

It seems that the role conflict leads to the employees' stress.

The analysis of the research third derivate question has indicated that the grade average of the influence of role conflict on stress has been 2/66, with the standard deviation of 0/708. According to the fact that the observed T at the level of $p < 0/01$ and (p=0/000) has been Significant, with the probability of 0/99, it can be concluded that:

The more role conflicts, the more stress.

The analysis of the indices related to the influence of a role conflict on stress has shown that the highest effect of conflicts in employees roles on stress relates to the nineteenth question (I hate waiting in most of the queues), with 73/4. In other words, most of the Red Crescent employees believe that they hate waiting in most of the queues.

Due to the research findings, it can be concluded that, The jobs which are assigned to individuals should contain coordinated duties so as to save the employees from being confused and minimize their stress. (p=0/200).

The comparison of the female and male answerers opinions has shown that the influence of conflicts in employees roles does not differ among men and women.

5: The examination of the research Fourth derivative question:

It seems that the contrast in employees personal relationships with other colleagues and managers Lead to stress.

The analysis of the research fourth derivative question has shown that the grade average of the influence of the contrast in employees personal relationships with other colleagues and managers on

the stress has been 3/063, with the standard deviation of 0/697.

Due to the fact that the observed T at the level of $p < 0/01$ and (p=0/000) has been significant, with the probability of 0/99, it can be concluded that there is not any significant relationships with other colleagues and managers and the stress. The analysis of the indices related to the influence of the contrast in employees personal relationships with other colleagues and managers on the stress has indicated that the highest influence of the contrast in employees personal relationships with other colleagues and managers on the stress, relates to the twenty-third question (I like to be in a busy environment and in communication with other) with 69/9. In other words, most of the employees of Red crescent believe that they are interested in being in busy environments and in communication with other individuals).

According to the research findings, it can be concluded that the Fars province Red Crescent employees do not agree with that the contrast in employees personal relationships with other colleagues and managers, Leads to the stress. Thus, the non coordinated jobs, do not have any influence on employees work, either.

The comparison of female and male answers opinions has illustrated that the influence of the contrast in employees personal relationships with other colleagues and managers on the stress, does not differ among men and women (p=0/100).

The suggestions regarding research Findings:

1: Due to the Fact that the job importance Lead to the reduction of stress among the employees, the significant indices should be identified and emphasized to them so, The superior managers should pay attention to the inferior employees by encouraging them.

2: Due to the Fact that the high volume of work causes stress among the employees, it is suggested to categorize the tasks and assign specified work for the employees working hours in order to diminish their stress.

3: According to the Fact that the conflict in employees, roles causes stress among, them, it is suggested to coordinate the individuals, tasks and duties through appropriate programming, to reduce their stress.

Because, the having the conflict in one's tasks and duties, causes confusion and decreases the performance.

4: It is suggested to be more relationships between employees and managers. In this way, the employees will be more sensitive about their tasks and the managers will be aware of their employees

duties, so as to offer strategies for eliminating the deficiencies.

5: It is suggest to display the employees tasks, not only as a pecuniary duty, but also as a spiritual one; Thus they will be more careful while working.

6: It is suggested to poll the employees and managers of the organization. So, those factors which cause the stress among the employees, will be identified and eliminated. In this way, the employees productivity will be enhanced.

According to the above findings, the average grade of the seventeenth question is 2/56, The eighteenth question: 1/71, the nineteenth question: 2/09, the twentieth question: 3/27, the twenty – first question: 2/90 and the twenty second question: 3/40. The highest collective percent of the alternatives "Fully agree" and "agree" with 73/4, relate to the nineteenth question (I hate waiting in long queues), and the lowest collective percent of the alternatives "Fully agree" and "agree" with 30/9, relate to the twenty – second question (The organizational climate and environment is not compatible with my interests and spirits).

The average grade of the answers has been fluctuated from 1/71 to 3/40 which indicates the agreement of the answerers with the influence of role conflict on employees stress.

Table 12: The comparison of the average grade of role conflict index, with the standard grade

$$H_0 = M \geq 3$$

$$H_1 = M < 3$$

H_0 = The role conflict does not lead to the employees stress.

H_1 = The role conflict Leads to the employees stress.

The average grade of the answerers has been 2/66, with the standard deviation of 0/708. Due to the Fact that the observed at the level of $p < 0/01$ has been significant, the zero presumption is rejected.

In other words, the role conflict leads to employees stress.

The examination of questions related to the research Fourth derivative hypothesis:

The research fourth derivative hypothesis: It seems that the contrast in employees personal relationships with other colleagues and managers lead to stress.

Table 1:the statistical society and necessary sample volume:

row	city	Number of employees	Number of distributed questionnaires	Number of returned questionnaires by the employees
1	Firooz-Abad	9	8	7
2	Lamerd	14	13	12
3	Shiraz	19	17	17
4	Fasa	8	8	7
5	Neyriz	6	6	4
6	Jahrom	9	6	6
7	Gerash	9	9	9
8	Khonj	12	11	11
9	Lar	7	7	6
10	Evaz	6	5	4
11	Darab	8	8	6
12	kAZEROON	8	8	7
total	12	115	106	94

Table 2: The consideration of questions related to the main hypothesis of the research.

Alternative		question1	question2	question3	question4	question5
Fully agree	Frequency	13	7	25	12	20
	Percent	13/8	7/4	26/6	12/8	21/3
agree	Frequency	19	29	28	8	33
	Percent	20/2	30/9	29/8	8/5	35/1
Without any ideas	Frequency	14	10	7	9	7
	Percent	14/9	10/6	7/4	9/6	7/4
Fully opposed	Frequency	22	25	19	37	12
	Percent	23/4	26/6	29/8	39/4	12/8
Opposed	Frequency	23	22	15	26	22
	Percent	24/5	23/4	26/6	27/7	23/4
The collective percent of "Fully agree" and "agree"		34	38/3	26/4	21/3	56/4
Average		3/25	3/27	2/69	3/61	2/8
Standard		1/41	1/32	1/45	1/33	1/50

Table 3: The comparison of the average grade of nerve pressure index with standard grade.

Index	Average	standard deviation	t	p
Nerve pressure	3/25	0/967	2/48	0/99

Table 4: The examination of questions related to the research first derivate hypothesis

Alternative		question6	question7	question8	question9	question10
Fully agree	Frequency	24	26	54	39	20
	Percent	25/5	27/7	57/4	41/5	21/3
agree	Frequency	40	45	34	31	26
	Percent	42/6	47/9	36/2	33	27/7
Without any ideas	Frequency	16	11	2	7	4
	Percent	17	11/7	2/1	7/4	4/3
Fully opposed	Frequency	4	5	1	4	17
	Percent	4/3	5/3	1/1	3/4	18/1
Opposed	Frequency	9	5	2	13	25
	Percent	9/6	5/3	2/1	13/8	26/6
The collective percent of "Fully agree" and "agree"		68/1	75/6	93/6	74/5	49
Average		2/29	2/10	1/52	2/15	3/01
Standard deviation		1/18	1/05	0/78	1/37	1/6

Table 5: The comparison of the average grade of job importance improvement index, with the standard grade.

Index	Average	standard deviation	t	p
Job experience	2/20	0/629	-11/94	0/000

Table 6: The examination of questions related to the research second derivative hypothesis:

Alternative		question11	question12	question13	question14	question15	question16
Fully agree	Frequency	23	16	11	27	24	14
	Percent	24/5	17	11/7	28/7	25/5	14/9
agree	Frequency	38	33	38	52	27	32
	Percent	40/4	35/1	40/4	55/3	28/7	32
Without any ideas	Frequency	6	12	13	3	3	12
	Percent	6/4	12/8	13/8	3/2	3/2	12/8
Fully opposed	Frequency	11	14	14	10	22	19
	Percent	11/7	14/9	14/9	10/6	23/4	20/2
Opposed	Frequency	16	18	18	2	18	16
	Percent	17	19/1	19/1	2/1	19/1	17
Collective percent of "Fully agree" and "agree"		64/9	52/1	52/1	48/9	54/2	48/9
Average		2/56	2/83	2/89	2/02	2/81	2/90
Standard		1/41	1/46	1/33	0/97	1/51	1/35

Table 7: The comparison of the average grade of the high volume of work index with the standard grade.

Index	Average	standard deviation	t	p
The high volume of work	2/67	0/629	-5/02	0/000

Table 8: The examination of questions related to the research third derivative hypothesis

Alternative		question17	question18	question19	question20	question21	question22
Fully agree	Frequency	21	39	42	12	19	6
	Percent	22/3	41/5	44/7	12/8	20/2	6/4
agree	Frequency	33	48	27	21	25	23
	Percent	35/1	51/1	28/7	22/3	26/6	24/5
Without any ideas	Frequency	10	4	9	14	12	14
	Percent	10/6	4/3	9/6	14/9	12/8	14/9
Fully opposed	Frequency	17	1	6	23	18	29
	Percent	18/1	1/1	6/4	24/5	19/1	30/9
Opposed	Frequency	13	2	10	24	18	22
	Percent	13/8	2/1	10/6	25/5	19/1	23/4
Collective percent of "Fully agree" and "agree"		57/4	12/6	73/4	35/1	47/8	30/9
Average		2/56	1/71	2/09	3/27	2/90	3/40
Standard		1/37	0/78	1/32	1/39	1/44	1/26

Table 9: The examination of question related to research fourth derivative hypothesis.

Alternative		question23	question24	question25	question26	question27	question28	question29	question30
Fully agree	Frequency	20	9	3	20	16	6	20	3
	Percent	21/8	9/6	3/2	21/3	17	6/4	21/3	3/2
agree	Frequency	45	29	18	24	35	16	40	13
	Percent		30/9	19/1	25/5	37/2	17	0/6	13/8
Without any ideas	Frequency	47/129	29	10	11	14	15	14	17
	Percent		30/9	10/6	11/7	14/9	16	14/9	18/1
Fully opposed	Frequency	12/58	10	39	17	17	31	8	23
	Percent		10/5	41/5	18/1	18/1	33	8/5	26/5
Opposed	Frequency	51/13	16	24	22	12	25	11	38
	Percent	11/7	17	25/5	23/4	12/8	26/6	11/7	40/4
The collective percent of "Fully agree" and "agree"		69/9	40/9	22/3	46/8	54/3	23/7	64/5	17
Average		2/37	2/94	3/67	2/95	2/72	3/56	2/46	3/58
Standard		1/223	1/227	1/14	1/49	1/29	1/23	1/25	1/19

Table 10: The comparison of the grade average of contrast index in personal relationships, with the standard grade.

Index	Average	The standard deviation	t	p
The contrast of personal relationships	3/063	0/697	0/88	0/810

Table 11: The comparison of average grades of both female and male answerers regarding the research indices.

Index	Female		Male		t	D
	average	variance	average	variance		
nerve pressure	3/45	0/85	30/16	1/01	1/33	0/185
job importance	2/38	0/69	2/13	0/59	1/69	0/093
The high volume of work	2/66	0/58	2/67	0/65	-0/05	0/95
The role conflict	2/69	0/80	2/63	0/66	0/34	0/73
The contrast in personal relationships	3/22	0/65	2/95	0/68	1/6	0/100

Table 12: The comparison of the average grade of role conflict index, with the standard grade

Index	Average	The standard deviation	t	p
role conflict	2/66	0/708	4/58	0/000

References:

1-kreitner, Robert qand Angele kinicki, Organizational Behavior, 2nd edition, Boston, MA:IRWN 1991

2-Nelson, Debra L.and Jears Cempbell Quick, Understanding Organizational Behavior:A Multimedia Approach, Cincinnati, Ohio:South-Western, 2002.

3-George Jennifer M. and Gareth R Jones, Undeestanding and Managing Organizational Behavior edititon Reading, Massachussts:Addisson-Wesley,1999

4-Schermerhorn, Jr, John R, James G.Hunt, and Richard N.Osborn, Managing Oganizational Behavior, 5th edition, New York : John Wiley, 1994

5-Jamal Muhammad, "Relationship of Job Stress and Type A Behavior to Employees Job Satisfaction, Organizational Commitment, Psychosomatic Health Problems, and Turnover Motivation", Human Relations, August 1990,pp 727-738.

6-Tipgos, M.A., "The Things That stress Us" Management World, June-August 197,pp.17-18.

7- Girdano,D.A., G.Everly, Jr.and D. E. Dusek, Controlling stress and Tension:A Holiistic Approach, 3rd ed., Englwood Cliffs,N.J.:Prentice Hall,1990.

10/10/2012

The effect of government size on inflation in Iran

Marzieh Esfandiari¹, Vahid Dehbashi², Hamid Mohammadi², Iman Shahraki³

¹: Department of Management, Zahedan Branch, Islamic Azad University, Zahedan, Iran

²: Department of Agricultural Economics, University of Zabol, Zabol, Iran

³: Student of Management, Science and Research Zahedan Branch, Islamic Azad University, Zahedan, Iran

marzieh_esfandiari@yahoo.com

Abstract: This paper explores the influence of government size on inflation with considering the major determinants of inflation in Iran. It has been tried to consider combination of theories about inflation to determine the important factors on inflation and to inference the role of government size. In order to investigating short run and long run relation between inflation and the government size in 1971-2008, the ARDL approach has been utilized. An empirical model has been constructed which considers the effects of liquidity, the government size, exchange rate, the investment of private sector, imported price index, the change of CPI in each year and two dummy variables for Iran-Iraq war and change in exchange system. The empirical results show that imported inflation, expected inflation and the size of government are the most important factors affecting on inflation in Iran. Also the findings indicate that a decline in the government size may lead to low inflation.

[Esfandiari M, Dehbashi V, Mohammadi H, Shahraki I. **The effect of government size on inflation in Iran.** *Life Sci J* 2012;9(4):2511-2515] (ISSN:1097-8135). <http://www.lifesciencesite.com>. 371

Keywords: Inflation; liquidity; exchange rate; government size; ARDL approach

1. Introduction

In developing countries, government plays an important role in planning organization and resources allocation. Revolution in Iran in 1978 and the Iran-Iraq war during 1980-1989 were caused to increase in government size. Most of the economic and social centers like banks, insurance institutes, hospitals and so on, which had been managed by private sector before, transferred to government after revolution.

More ever, inflation rate in Iran was double digit in those years. There are a number of causes of

inflation which are related to expansive monetary or physical policy (or both) and this type of inflation can be referred to as demand – pull in nature. Inflation can also stem from profit or wage rises and this is classified as either aggregate, sectoral or cost – push inflation. Inflation resulting from temporary causes, such as those initiated by war or natural disaster, are easily identified. Higher prices for goods and services imported from abroad and other external circumstances can also affect the domestic economy, causing inflation. This is import – induced inflation (Pahlavani,Rahimi).

Table1. Inflation rates based on CPI

Revolution period 1979-1980	War period 1980-1989	First development plan 1990-1994	Between first and second development plan 1995	Second development plan 1996-2000	Third development plan 2001-2005	forth development plan 2006-2008
10%	19.8%	18.8%	35%	22.5%	14.12%	14.7%

As in table 1 is reported, inflation in Iran during last three decades had ascendant progress. During 1974-1978, because of high increase in oil price, inflation rate reached to 15.6%. After the revolution in 1979-1980, inflation rate decreased to 10%. Then because of economic sanction during the Iran-Iraq war period, the rate of inflation raised to 19.8%. In the last year of the war the ratio of budget deficit to government budget reached the incredible rate (50%). After the war and during the first development plan, inflation rate decreased to 18.8%. Executing unsuitable strategies, especially in

exchange market caused to economic crisis. In 1994, which was between the first and the second development plan, there was again increase in inflation rate. This process continued and reached to 49% in 1995.

On the other hand Positive effects of foreign incomes and production and oil price increase caused to decrease in inflation expectations. Using the exchange reserves increased the ratio of total demand to supply in the third year of third development plan. The bonds were sold in order to liquidity shrinking by central bank, caused to decrease in inflation rate in

the first year of the fourth development plan. Finally in 2006 because of increase in exchange reserves, a rapid increase in inflation was seen.

The literature on inflation determinants is relatively extensive. Examples include Adedeji and Liu (2000), Aljebrin (2006), Bahmani-Oskooee (1995), Delavano and Vilanueva (1993), Tashkini and Abasinegad (2004), Pahlavani and Rahimi (2009), Pesaran (2000). The focus of these earlier is mostly based on monetary viewpoint of inflation and sometimes on the effect of expectation on inflation forming. In previous studies, monetary aspect of inflation and its psychic affects were reviewed and in some studies the exchange rate has been applied in model as imported inflation.

However there are a few Studies on the government size effect on inflation. The paper closest to ours in motivation is that of Han and Mulligan (2008). They have shown the big government and inflation are related in special cases like war time. Contrary in peace time there is a weak positive correlation between government size and inflation.

$$P = (GM_2)^{\alpha_1} (EX)^{\alpha_2} (G)^{\alpha_3} (DP)^{\alpha_4} (PM)^{\alpha_5} \quad (1)$$

This function can also be written as:

$$\ln(P_t) = \alpha_1 \ln(GM_2) + \alpha_2 \ln(EX) + \alpha_3 \ln(G) + \alpha_4 \ln(DP) + \alpha_5 \ln(I) + \alpha_6 \ln(PM) \quad (2)$$

Where:

P_1 : domestic prices

GM_2 : growth rate of liquidity

EX : the exchange rate

G : the ratio of government expenditure to GDP (as an indicator of structural inflation)

DP : change in domestic prices (as an indicator of expectation inflation)

This study focuses on the relationship between government size and inflation with considering the major determinants of inflation in Iran. To do so, a theoretical model of inflation is constructed here, based on the study of Aljebrin (2006). The study has been employed annual time series data (1971-2008) in order to investigate the effect of government size on inflation in Iran.

The rest of the paper is organized as follows. Section 2 describes the model and data. In section 3 and 4 the methodology and the empirical evidence are presented respectively. Finally, conclusions are summarized in section 5.

2. Material and Methods

Data set of this study is annual and based on studies done in 1971 – 2008 time period. These data are collected from statistics of central bank of Islamic republic of Iran statistic center. In order to analyze the impact of the government size on inflation, a theoretical model has been constructed. According to Aljebrin (2006) the theoretical framework of our model is as follows:

I : the ratio of private investment to GDP (as an indicator of cost – push inflation)

PM : foreign prices (as an indicator of imported inflation)

Furthermore, we consider two Dummy variables to capture the effect of revolutions (1977 , 1978) and exchange system change from fixed to managed float (1994 , 1995). Finally the following equation has been used as the estimation process:

$$\ln(P_t) = \alpha_0 + \alpha_1 \ln(GM_2) + \alpha_2 \ln(EX) + \alpha_3 \ln(G) + \alpha_4 \ln(DP) + \alpha_5 \ln(I) + \alpha_6 \ln(PM) + D_{57} + D_{74} \quad (3)$$

Where:

$$D_{57} = \begin{cases} 1 & \text{for: 1977, 1978} \\ 0 & \text{others} \end{cases} \quad D_{74} = \begin{cases} 1 & \text{for: 1994, 1995} \\ 0 & \text{others} \end{cases}$$

To examine the existence of the long-run relation between inflation and its determinants as formulated in equation (3) we apply the ARDL Co-integration approach.

The results of the ARDL Co-integration approach using traditional estimation methods is based on stationary of variables. But in many cases this is not true. So it's necessary to be sure about

stability of variables and for this reason we use augmented Diki-Fuller test. According to the ADF Test, P , GM_2 , EX , G and ΔP are $I(1)$ and Pm is $I(0)$. The autoregressive distributed lag (ARDL) approach is a new Co-integration technique for determining long-run relationship among variables under study. There are some advantages for ARDL approach as follow while other Co-integration

techniques require all of the repressors to be integrated of their order of integration. According to Ghattak and Siddiky (2001), ARDL approach is a better method in small samples. Moreover, with this approach, it is possible that different variables have

different optimal numbers of lags. Because of these advantages, ARDL is used in this study. Following Pesaran (2001) the error correction representation of the ARDL model is as follows.

$$\begin{aligned} \Delta LP = & a_0 + \sum_{j=1}^n b_j \Delta LP_{t-j} + \sum_{j=1}^n c_j \Delta LGM2_{t-j} + \sum_{j=1}^n d_j \Delta LEX_{t-j} + \sum_{j=1}^n e_j \Delta LG_{t-j} \\ & + \sum_{j=1}^n f_j \Delta LI_{t-j} + \sum_{j=1}^n g_j \Delta LPM_{t-j} + \sum_{j=1}^n h_j \Delta LDP_{t-j} + \delta_1 \Delta LP_{t-1} + \delta_2 \Delta LGM2_{t-1} \\ & + \delta_3 \Delta LEX_{t-1} + \delta_4 \Delta LG_{t-1} + \delta_5 \Delta LI_{t-1} + \delta_6 \Delta LPM_{t-1} + \delta_7 \Delta LDP_{t-1} + D74 + \varepsilon_{1t} \end{aligned} \quad (4)$$

The parameter, δ_i where $i=1, 2, 3, 4, 5, 6$ is the corresponding long-run multipliers. While the parameters $b_j, c_j, d_j, e_j, f_j, g_j, \dots$ are short-run dynamic coefficients of the underlying ARDL model.

3. Results and discussions

To estimation the model we use 37 annual observation, according to the Schwarz–Bayesian criteria (SBC), 4 was chorea as the maximum lag length.

Table2. Estimated short-run coefficients using the ARDL approach

Regressor	Coefficient	Standard Error	T-Ratio Prob
LP(-1)	.861840	0.0098142	87.8155 (0.000)
LGM2	.0530790	0.012493	4.2486 (0.016)
LEX	-0.015652	0.015479	-1.0112 (0.324)
LG	0.052474	0.022683	2.7542 (0.012)
DLPM	0.10217	0.026179	3.9027 (0.001)
LDP	0.097373	0.0070113	13.8879 (0.000)
C	0.23944	0.027194	8.8049 (0.000)
LI1	-0.063986	0.018928	-3.3804 (0.006)
D57	0.0091095	0.0041716	2.1837 (0.041)
D74	0.021857	0.0047392	4.6157 (0.000)
$R^2 = 0.99$	$\bar{R}^2 = 0.99$	DW=2.1561	F = 158852.6

Table 2 reports the results of short-run estimation of the ARDL model. All the variables have the significant effect (at 5 % level) and the imported inflation is the most effective variable. The

dummy variable coefficients are significant and positive imply that revolution and exchange policies have effected on inflation in Iran.

Table3. Estimated long-run coefficients using the ARDL approach

Regressor	Coefficient	Standard Error	T-Ratio Prob
LGM2	0.01943	0.07246	2.6281 (0.016)
LEX	0.14405	0.047269	3.0474 (0.006)
LG	0.45218	0.17785	2.5425 (0.019)
DLPM	0.73949	0.21769	3.3971 (0.003)
LDP	0.78766	0.084548	9.3161 (0.000)
C	1.7331	0.18969	9.1362 (0.000)
LI1	-0.54483	0.16606	-3.2809 (0.013)
D57	0.065934	0.030619	2.1534 (0.044)
D74	0.15833	0.037476	4.2248 (0.000)

Now, we estimate the long-run ARDL model. Table 3 shows the long-run coefficients of variables under investigation. As expected, empirical

results in tables 3 reveal that liquidity exchanges rate, government size, expected inflation and imported inflation are significant.

Table4. The results of error correction model (ECM)

Regressor	Coefficient	Standard Error	T-Ratio Prob.
dLGM2	.0530790	0.012493	4.2486 (0.016)
dLEX	-0.015652	0.015479	-1.0112 (0.324)
dLG	0.052474	0.022683	2.7542 (0.012)
dDLPM	0.10217	0.026179	3.9027 (0.001)
dLDP	0.097373	0.0070113	13.8879 (0.000)
dC	0.23944	0.027194	8.8049 (0.000)
dLI	-0.063986	0.018928	-3.3804 (0.006)
dD57	0.0091095	0.0041716	2.1837 (0.041)
dD74	0.021857	0.0047392	4.6157 (0.000)
ECM	-0.13816	0.0098142	-14.0777 (0.000)

Table 4 reports the results of the error correction term shows the speed of adjustment of short-run model regarding to equilibrium state.

According to table 4 the ECM term is -.1386 and highly significant. It means that in each year about 13% of deviation is corrected.

The result of diagnostic tests for serial correlation, functional form, normality and heteroscedasticity are shown in table5. The result define that model was specified well.

Finally, that cumulative sum of recursive residuals (CUSUM) and the cumulative sum of squares (CUSUMSQ) tests were applied to test for parameter constancy. Figure plots the CUSUM and

CUSUMSQ statistics. The results clearly indicate the absence of any instability of the coefficients during the investigated period.

Table 5-The results of diagnostic tests

Test Statistics	Aim	Prob.
LM	Serial Correlation	0.171
RAMSEY RESET	Functional Form	0.834
NORMALITY	Normality	0.294
WHITE	Heteroscedasticity	0.789

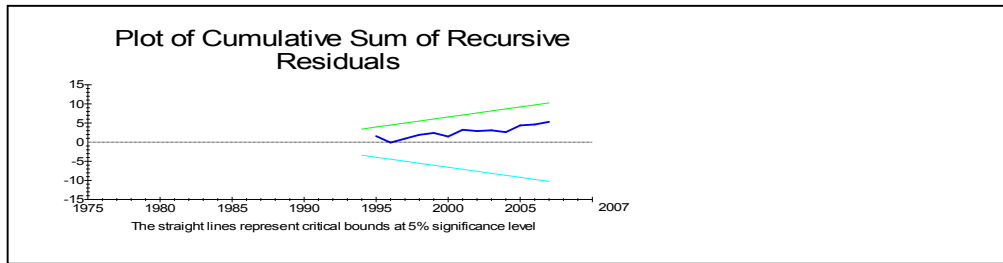

Figure 1. The plot of CUSUM statistics for coefficient stability test

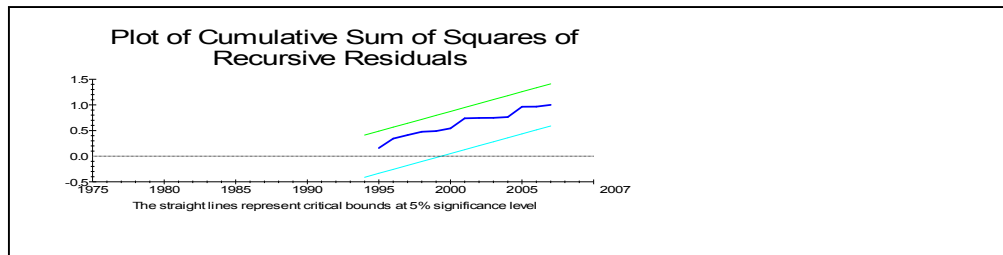

Figure 2. The plot of CUSUM statistics for coefficient stability test

4. Conclusion

Inflation is one of the most important problems in Iran. In this paper, we tried to determine the important factors on inflation in Iran during 1971-2008 with emphasizing on the role of government size by applying the ARDL approach.

Based on empirical results, the size of government has significant and positive effect on Iran's inflation. In both the long-run and short-run, imported inflation has the most significant impact on inflation, in which one percent increase in imported inflation rate leads to 0.1 percent increase in inflation. And the expected inflation has the second place in Iran's inflation.

Diagnostic and stability tests prove model specification is done well and ECM term shows that in each year about 15% of deviation is corrected and after 7 years will be completed.

Thus, considering obtained results, a decline in government size may lead to decline in inflation in Iran. It seems that Iranian's policy makers can decrease inflation with more emphasis on privatization and execute of Article 44 of the constitution.

Corresponding Author:

Marzieh Esfandiari
Department of Management
Zahedan Branch
Islamic Azad University
Zahedan, Iran
E-mail: marzieh_esfandiari@yahoo.com

References

1. Adediji, O.S. & Liu, O. (2000). An Analysis of Money Demand and Inflation in the Islamic Republic of Iran, A Macroeconomic Analysis. *IMF Working Paper*. (pp.127: 1-28).
2. Aljebrin, M. (2006). Analysis of Inflation Determinants in Developing Oil-Export Based Economies, *Doctoral Dissertation*, Colorado state University.
3. Bahmani-Oskooee, M., (2001). How stable is M2 money demand function in Japan? *Japan and World Economy* (13: 455-461).
4. Bahmani-Oskooee, M. and A. Nasir, (2004). ARDL Approach to Test the Productivity Bias Hypothesis. *Review of Development Economics*, 8(3): 483-488.
5. Bonato, Leo, (2004), Money and Inflation in the Islamic Republic of Iran, *IMF working papers*, Middle East Central Asia Department.
6. Ghatak S. and Siddiki, J., (2001). The Use of ARDL Approach in Estimating Virtual Exchange Rates in India, *Applied Statistics*. 28: 573-58.
7. Han, S. and Muligan, A. (2008). Inflation and the size of government, *Federal Reserve Bank of St. Louis review*, 90(3, part2): 245-67.
8. Pahlavani, M. and Rahimi, M. (2009). Sources of Inflation in Iran: An application of the ARDL Approach, *International Journal of Applied Econometrics and Quantitative Studies*. Vol.9(1).
9. Pesaran, M.H. and Pesaran, B., (1997). *Working with Microfit4.0: Interactive Econometric Analysis*, Oxford: Oxford University Press.
10. Pesaran, M.H., Shin, Y., (1996). Co integration and Speed of Convergence to Equilibrium. *Econometrics* 71(1-2): 117-43.
11. Pesaran, M. H., Shin, Y. and R.J. Smith, (2001). Bounds Testing Approaches to the Analysis of Level Relationships, *Applied Econometrics* 16(3): 289-326.
12. Pesaran, M. H. and R., (1998). Smith Structural Analysis of Co integration VARs, *Journal of Economic Surveys*. 12(5): 471-505.

10/14/2012

Screening Of Antimicrobial Activity Of Sesquiterpenoid Crude Extract Of *Ganoderma*

Asgar.Sharifi¹, Seyed Sajjad Khoramrooz¹, Soheyla Jahedi³, Seyed Abdolmajid Khosravani¹

1. Department of Microbiology, Medical Microbiology Research Center, School of Medicine, Yasuj University of Medical Sciences, Yasuj, Iran.
2. Department of Parasitology and Mycology, School of Medicine, Shiraz University of Medical Sciences, Shiraz, Iran.
3. Farhangian University of Shiraz, Iran
khosravani2us@yahoo.com

Abstract: Antimicrobial activities of sesquiterpenoid of *Ganoderma* were tested against human pathogenic microorganisms. Four out of 11 species of *Ganoderma* showed good antimicrobial activity. Minimal inhibitory concentration was determined for the sesquiterpenoid extract of *Ganoderma* Mazandaran *Ganoderma* lipsiense, *Ganoderma* multicornum and *Ganoderma* lucidum on selected microorganisms. *Proteus mirabilis* (MTCC 1429) *Candida albicans* (MTCC 1637), *Klebsiella pneumonia* (MTCC 432), *Escherichia coli* (MTCC 2064) and *Bacillus subtilis* (NCIM 2010) were tested. *Ganoderma* lucidum extract showed maximal inhibition of *Proteus mirabilis* and was also active against *Candida albicans*, as was the extract of *Ganoderma* mazandaran. Lowest MIC values were 128 μ g/ml demonstrated by sesquiterpenoid extract of *G. lucidum*, and *G. Mazandaran* against *B. subtilis* and *P.mirabilis*. Further separation of the sesquiterpenoid compounds need to be carried out to detect the bioactivity of specific compounds.

[Asgar.Sharifi, Seyed Sajjad Khoramrooz, Soheyla Jahedi Seyed Abdolmajid Khosravani. **Screening Of Antimicrobial Activity Of Sesquiterpenoid Crude Extract Of *Ganoderma***. *Life Sci J* 2012;9(4):2516-2519] (ISSN:1097-8135). <http://www.lifesciencesite.com>. 372

Keywords: Antimicrobial activity, *Ganoderma*, Standard Antibiotics, sesquiterpenoid Extraction

1. Introduction

Antimicrobial activity is the ability of a substance to inhibit growth and reproduction or to kill microorganisms. A chemical, at low concentration, should have a broad spectrum of antimicrobial activity, which means that it should inhibit or kill many different kinds of microorganisms. Most pathogenic bacteria and fungi are susceptible to antibiotics or other antimicrobial agents and their response towards these antibiotics, however varies enormously (1). Antimicrobial agents include antibiotics and antimicrobial metabolites produced by one microorganism which inhibits the growth of other organism (2). Several antimicrobial metabolites have been isolated from mushrooms like *Ganoderma* and have a potent antiviral, bacterial and fungal activity (3-4). *Ganoderma* spp have been economically important fungi, for over 4000 years particularly in the Far East countries, and used as antitumor activity (5-6). The reasons for the use of *Ganoderma* spp were to prevent, cure, treatment of cancer, diarrhea, and excessive salivation (7). This report elucidates interesting chemical compounds extracted (sesquiterpenoid), purified and identified from fruit bodies of *Ganoderma* as a bioactive agents tested against a selected isolates of microorganisms. The aims of the present study are to screen antimicrobial activities of sesquiterpenoid extracts of *Ganoderma* on selected microorganisms.

2. Material and Methods

In this present work *P. mirabilis* MTCC 1429, *C.albicans* MTCC 1637, *K. pneumonia* MTCC 432, *E.coli* ATCC 2046, *B. subtilis* NCIM 2010 and *S. aureus*, were used as test microorganisms for sesquiterpenoid samples extracted from *Ganoderma* for their antimicrobial activity. Culture medium for bacteria: nutrient agar (1.0g beef extract, 2.0g yeast extract, 5.0g peptone, 5.0g sodium chloride, 20.0g agar, 1000 ml DW, pH was adjusted to 7.0-7.5).

Culture medium for *Candida albicans* was Yeast extract peptone dextrose agar (YEPD), (3.0g yeast extract, 10.0g peptone, 20.0g dextrose, and 15.0g agar, 1000 ml DW). The cultures were maintained as slants incubated at 37 °C. Sub culturing was done every two weeks for bacteria and yeast.

Preparation of inoculums:

A loop full of freshly isolated colonies of bacteria and yeast were suspended in 0.85% saline and/ or sterile distilled water.

Well Assay Method.

The well assay method was according to Barry (1986). In brief, the agar plates were prepared in accordance to the organism (as given previously). The plates were inoculated using a sterile cotton swab by spreading the inoculums evenly over the surface of the medium. Inoculums were left for few minutes to dry, with the lid closed at room temperature, wells were made with a cork borer

(6mm), and sample extracts of fungi were added to the wells (50µl in each well), also containing a well with positive control (methanol). The plates were incubated at 35-37 °C for 18-24 hours. The activity was calculated by measuring the diameter of zone of

inhibition (including the diameter of the well) to the nearest millimeter. The results of the test and control plates were compared.

Table 1. *Ganoderma* spp used:

Name of Species	Samples NO.
<i>Ganoderma applanatum</i> (Pers.) Pat.	GA-02.
<i>Ganoderma capense</i>	GA-06
<i>Ganoderma chalceum</i>	GA-39
<i>Ganoderma lipsiense</i> (Batsch.) Murill	GA-19
<i>Ganoderma lucidum</i> (Curtis; (Fr.) P Karst Var. <i>lucidum</i> .	GA-34, GA-38, GA-10
<i>Ganoderma lucidum</i> var. <i>microsporus</i> .	GA-16
<i>Ganoderma multicornum</i> (P Karst var.)	GA-28
<i>Ganoderma multiplicatum</i> (Mont.) Pat.	GA-12, GA-27
<i>Ganoderma perzonatum</i> (Murrill)	GA-36
<i>Ganoderma Mazandaran</i> (proposed new species).	GA-11
<i>Ganoderma praelongum</i> (Murrill)	GA-37
<i>Ganoderma</i> sp.	GA-K, GA-S
<i>Ganoderma stipitatum</i> (Murrill)	GA-07

Table 2: Antimicrobial Activity of Sesquiterpenoid Extract From *Ganoderma* Samples Against Human Pathogen Microorganism

Samples	<i>P. mirabilis</i>	<i>C. albicans</i>	<i>K.pneumonia</i>	<i>S.areus</i>	<i>E. coli</i>	<i>B. subtilis</i>
<i>G. mazandaran</i>	25	24.6	17.6	20.6	24.67	28.3
<i>G.lipsiense</i>	25.3	24.3	16.67	22.6	19	21.67
<i>G.multicornum</i>	23.3	21.3	18.33	21.67	23	22.67
<i>G. lucidum</i>	31.3	27.3	21.67	29	30.67	32.67

For bacteria Nutrient Broth (NB) and for fungi Yeast

Table 3: Determination of the Minimum Inhibitory Concentration (MIC) of *Ganoderma* Samples against Human Pathogenic Microorganisms.

Sample	Name of microorganisms (MIC µg/ ml)					
	<i>E. coli</i>	<i>S.areus</i>	<i>K.pneumonia</i>	<i>P. mirabilis</i>	<i>C. albicans</i>	<i>B. subtilis</i>
<i>G. mazandaran</i>	64	64	64	32	64	32
<i>G.lipsiense</i>	64	64	64	32	32	32
<i>G.multicornum</i>	32	32	64	64	64	64
<i>G. lucidum</i>	32	32	32	32	32	32

Sample collection: *Ganoderma* spp were collected from different parts of Mazandaran province (Northern of Iran), brought to laboratory and air-dried in Department of Microbiology at Yasouj University of Medical Sciences, then it was ground and maintained in airtight plastic bag for further use (Table 1).

Identification:

The *Ganoderma* spp were identified using keys and morphological characters mentioned by Steyaert (8) and Ryvarden (9).

Sesquiterpenoid Extraction:

5gm of powder was extracted with 100ml (X 2) of chloroform overnight with initial warming. The

filtrates were combined and evaporated under vacuum. The residue was dissolved in 25ml of ethanol (95%) and 25ml of lead acetate (4% aqueous). The solution was evaporated under vacuum; the resulting residue was dissolved in chloroform and again evaporated to dryness under vacuum. The residue was collected, weighed, dissolved in methanol and used for further TLC analysis. Solvent System: Chloroform: Methanol (9:1). (10)

Minimum inhibitory concentration (MIC):

The lowest concentration of the antimicrobial extract inhibiting the visible growth after overnight incubation is denoted as MIC. MIC of

the extract for bacteria was determined using broth dilution method. To determine Minimum Lethal Concentration (MLC), a known quantity of inoculum from each of the tubes of broth that showed no visible turbidity is sub-cultured to solid agar plate. The lowest concentration of antimicrobial agent that allowed less than 0.1% of the original inoculum to survive is said to be the MLC. The results of MIC are usually the same results of MLC, or one tube before MIC.

Potato Dextrose Broth (YPDB) was used. The solutions, the methanol solution with the extract, were serially diluted in respective media to obtain dried extract concentrations of 128, 64, 32, 16, 8, 4 and 2 mg ml⁻¹. The experiments were performed in triplicate and analyzed by SPSS.

Tested cultures in this study were *P. mirabilis*, *C. albicans*, *K. pneumoniae*, *S. aureus*, *E. coli* and *B. subtilis*. The cultures were maintained as slants, which were incubated at 37 °C. The sub culturing was done every two weeks. Each experiment was done in triplicate and analyzed by ANOVA test.

3. Results

The sesquiterpenoid extract of *Ganoderma Mazandaran*, *Ganoderma lipsiense*, *Ganoderma multicornum* and *Ganoderma lucidum*, from Mazandaran, Iran, were tested for antimicrobial activity by the disc diffusion agar method.

Strong = zone of inhibition equals or greater than 21mm

Moderate = zone of inhibition equals 11 mm to 20 mm

Weak = zone of inhibition equals or less than 10 mm

Data represented in Table 2 showed that, *G. lucidum* strongly inhibited the growth of *E. coli*, *P. mirabilis*, and *B. subtilis* with inhibition zone diameters of (30.69 mm), (31.3, mm), (32.67 mm) respectively. Similarly, the effect of commonly used antibiotics (for fungi we used fluconazol, and for bacteria nitrofurantoin, trimethoprim sulfamethoxazol, amikacin, tetracycline, penicillin, gentamycin, cefalotine, and polymixin B were used) was tested against these microorganisms and showed that they were highly resistant to at least one antibiotic ($P < 0.01$).

Ganoderma mazandaran showed maximum zone of inhibition of 28.3mm on *B. subtilis* and minimum zone of inhibition (17.6mm) on *K. pneumoniae*, while *Ganoderma lipsiense* showed 23.3mm, 22.67mm and 21.3mm zone of inhibition on *P. mirabilis*, *B. subtilis* and *C. albicans* respectively, *G. multicornum* showed the maximum zone of inhibition (23.3mm) by for *P. mirabilis*.

The MIC value of sesquiterpenoid extract of *G. lucidum* against *P. mirabilis*, *E. coli*, *S. aureus*, *K.*

pneumoniae and *C. albicans* (Table 3) was 32 µg/ml. Our results also indicates that the MLC values for *P. mirabilis* and *C. albicans* was 64µg / ml respectively. The MIC of *G. mazandaran* was 32 µg/ml by *P. mirabilis* and 64µg / ml in the other present microorganisms, *Ganoderma lipsiense* showed that MIC=32µg / ml on *E. coli* and *S. aureus* and 64µg / ml on other microorganisms, MIC= 32µg / ml by *G. lipsiense* against *P. mirabilis*, *B. subtilis* and *C. albicans* and 64 µg / ml on other present microorganisms.

4. Discussions

Research for novel antibiotic is of utmost importance since most microorganisms have developed resistance to many antibiotics. The present work was carried out using extract from 11 *Ganoderma* spp. to search for novel compounds. Although, a few reports on bioactive compounds of *Ganoderma* spp are available (11-12). The results obtained in our study clearly indicate that extracts of mushrooms belonging to *Ganoderma* spp. possess potent antimicrobial activity.

Our present study revealed that purified sesquiterpenoid extract of *G. lucidum* exhibited an inhibitory effect against bacteria and fungi. These findings are in concomitant with other studies (13-14) *G. stipitatum* was active against Gram negative and Gram positive bacteria.

Apparently, the sesquiterpenoid extract of *G. Mazandaran*, *G. lipsiense*, *G. multicornum* and *G. lucidum* were potent and effective against the fungal isolates (*C. albicans*) since zone of inhibition of growth (23.3 mm to 31.3 mm) was observed in contrast with earlier findings regarding the antibiotics (14). In contrast Smala et al. (15) stated that *G. annulare* produces applanoxidic acid which showed a weak activity against the dermatophyte *T. mentagrophyes*.

According to Gao et al (16), *G. lucidum* and other *Ganoderma* species, more often in combination with chemotherapeutic agents, have been used to treat various bacterial diseases. They have suggested that the sesquiterpenoid components play an important role in its bioactive principle. Therefore it could be concluded from our results *G. Mazandaran*, *G. lipsiense*, *G. multicornum* and *G. lucidum* spp could be employed to combat several diseases caused by pathogenic microorganisms. Nevertheless, there is still more mushrooms needed to be examined for their potentiality activities against bacteria and pathogenic fungi.

Acknowledgements:

Authors are grateful to the research deputy and Clinical Microbiology Research center of Yasuj

University of Medical Sciences for financial support to carry out this work.

Corresponding Author:

Dr. Seyed Abdolmajid Khosravani
Department of Microbiology, Medical Microbiology
Research Center, School of Medicine, Yasuj
University of Medical Sciences, Yasuj, Iran.
E-mail: khosravani2us@yahoo.com

References

1. 1- Pelczar, M.J.; Jr.E.C.S. Chan.; and Noel. R. Krieg (1993) Microbiology concepts and applications; international edition. Published by: MC GRAW-Hill, INC. P. 162-582
2. 2- Hugo, W.B.; and A.D.Russell (2003) Pharmaceutical microbiology, sixth edition, Blackwell science, United Kingdom, p.91-336
3. 3- Jonathan SG, Kigigha ,LT and Ohimain E (2008) Evaluation of the Inhibitory potentials of eight edible higher Nigerian fungi against pathogenic Microorganisms. Afric J Biomed Res, 11:195-200.
4. 4- Jonathan SG and Awotona FE (2010) Studies on Antimicrobial Potentials of three Ganoderma species. Afric J Biomed Res, 13:119-125.
5. 5- Mizushima, Y.; Hanashima, L.; Yamaguchi, T.; Takemura, M.; Sugawara, F.; Saneyoshi, M.; Matsukage, A.; Yoshida, S.; Sakagushi, K (1998) A mushroom fruiting body-inducing substance inhibits activities of replicative DNA polymerases. Biochem. Biophys. Res. Commun. 249, 17-22.
6. 6- Chiu, S.W.;Wang, Z.M.; Leung, T.M.; Moore, D (2000) Nutritional value of Ganoderma extract and assessment of its genotoxicity and antigenotoxicity using comet assays of mouse lymphocytes. Food Chem. Toxicol., 38, 173-178.
7. 7- Vaidya,J,G and P.Y,Lamrood(2000) Traditional medicinal mushrooms and fungi of India.International journal of medicinal mushrooms 2(3):209-214
8. 8- Steyaert, R.L. Species of Ganoderma and related Genera(1972) mainly of the Bogor and Lieden Herbaria. Personia; 7(1): 55-118.
9. 9- Ryvardeen, L.(2000) Studies in Neotropical polypores 2: a preliminary key to Neotropical species of Ganoderma with a laccate pileus. Mycologia; 92(1): 180-191.
10. 10- Tawfik M. Muhsin, Abdul-Hafiz A. Al-Duboon and Kawther T. Khalaf (2011) Bioactive Compounds from a Polypore Fungus Ganoderma applanatum (Per s. ex Wallr.) Pat. Jordan Journal of Biological Sciences. 4, 205-212.
11. 11- Mothana RA, Jansen R, Julich WD and Lindequist U.(2000). Ganomycin A and B, a new antimicrobial farnesyl hydroquinones from the basidiomycetes Ganoderma pfeiffer. J. Nat. Produc. 63: 416-418.
12. 12- Keypour S, Riahi H, Moradali MF, Rafati H (2008) Investigation of the antibacterial activity of a chloroform extract of Ling Zhi or Reishi Medicinal Mushroom, Ganoderma lucidum (W.Curt.: Fr) P. Karst. (Aphyllphoromycetidae) from Iran. International Journal of Medicinal ushrooms, 10(4): 345-349.
13. 13- Kim HW, Kim BK(2002) Recent advances on the biologically active triterpenoids of Ganoderma lucidum. In: Ganoderma: Genetics, Chemistry, Pharmacology and Therapeutics. ZB Lin (Ed), Beijing Medical University Press, Beijing, , pp: 10-19.
14. 14- Smania A, Monache FD, Loguericio C, Smania EF and Gerber AL.(2001). Antimicrobial activity of basidiomycetes. Int .J. Med. Mush., 3: 87.
15. 15- Smala EF, Monache DF, Smania JA and Cuneo YR.(2003). Antifungal activity of sterol and triterpenes isolated from Ganoderma annulanane. Fitoterapia. 74: 375-377.
16. 16- Gao Y, Zhou S, Huang M, Xu A (2003) Antibacterial and antiviral value of the genus Ganoderma P. Karst. Species (Aphyllphoromycetidae) : A review. Internationa Journal of Medical Mushroom; 5(3): 235-246.

10/11/2012

Factors Influencing Households' Environmental Hazard Exposure in Ibadan Metropolis

Abayomi Samuel Oyekale

Department of Agricultural Economics and Extension, North-West University Mafikeng Campus, Mmabatho 2735 South Africa. asoyekale@yahoo.com

Abstract: Environmental hazards constitute a lot of economic development bottlenecks in Nigeria. In this study, the different forms of environmental problems facing households Ibadan were identified and composite indicators of hazard vulnerability were computed from them. Data were collected from 120 households from Ibadan metropolis using the stratified sampling method. Data were analyzed with the Factor Analysis and ordinary least Square (OLS) regression. The results show that majority of the households were faced with bushy and untidy environment, illegal structure/urban slum and improper disposal of domestic wastes. Regression results show that female household heads were significantly more vulnerable to domestic and air pollution hazards ($p < 0.05$). Also, as income increased, exposure to domestic and water pollution hazards significantly decreased ($p < 0.05$). The study recommended serious enforcement of existing environmental laws in order to ensure safe environment for residents of Ibadan, among others.

[Abayomi Samuel Oyekale. **Factors Influencing Households' Environmental Hazard Exposure in Ibadan Metropolis.** *Life Sci J* 2012;9(4):2520-2527]. (ISSN: 1097-8135). <http://www.lifesciencesite.com>. 373

Keywords: environmental hazards, vulnerability, Factor Analysis, urban households, Ibadan

INTRODUCTION

Upsurges in urban population growth, without adequate initiatives for waste management have resulted in catastrophic environmental situations in many Nigerian cities. The dynamics of spatial urbanization in Nigeria can be reflected from social infrastructure proliferation since 1815. Prior to national independence in 1960, the growth patterns of urban centers were drastically influenced by creation of new towns, modernizing physical structures of existing towns and provision of some basic social infrastructures. Some political and economic influences have also resulted in rapid urbanization and population growth (Ekundare, 1973).

Although Nigeria's demographic statistics are sometimes contentious, available data suggest that urban growth has continued unabated (Ayedun *et al.* 2011). Falade (1998) submitted that with annual growth rate of more than 6 percent, Ibadan, Lagos and Port-Harcourt are among Nigerian cities that have surpassed the average national urban growth of 3.6 percent. Alkali (2005) also noted that while average growth rate of Nigerian population was 2.8 percent, urban population had grown at about 5.8 percent since mid-1980s. Given that about 7 percent, 15 percent, 23.4 percent, 43.5 percent and 50 percent of Nigerian populations were living in urban centers in 1945, 1950, 1975, 2000 and 2010, respectively, there are enough statistics to prove the catastrophic tendencies of urbanization (Onibokun and Kumuyi, 1996; Ujoh *et al.*, 2010; Ayedun, 2011).

The Nigerian Constitution charges the states with the responsibility of ensuring environmental protection within their domains. Each of the local

governments within the states is also mandated according to state legislatures to ensure safe environment. However, several urbanization prompted environmental hazards are common phenomena in many Nigerian cities, majority being the state capitals. The situation in Ibadan is worrisome because the city is endowed with large land areas, which if well planned and judiciously utilized could have made the town an epitome of indescribable beauty.

Specifically, lack of adequate planning, foresights and inability of successive governments to adequately enforce civic compliance with existing environmental laws are notable among the problems that had aggravated environmental hazards. Similarly, corruption in the civil service has influenced the manners in which environmental officers and those that are charged with the responsibility of urban planning carry out their duties. Therefore, recent environmental decays are products of serious enigmas of abject policy failure, which no doubt engenders other adverse socio-economic development consequences (Omoleke, 2004).

Specifically, we now have some of our urban main roads being decorated with heaps of waste disposal bags, drainage channels are blocked with waste materials, major streets are littered with waste papers, nylons and sometimes human excreta and people are denied fresh air due to air pollution. It is therefore pathetic that our governments, more often lack adequate strategies to address emerging environmental challenges in our cities. This, having being the norms in governance has resulted in a

situation whereby Nigerian cities have been ranked among the dirtiest in the world. (Omoleke, 2004; Alabi, 2004)

Environmental pollution is directly related with population density (Inyang, 1997). This explains persistent concentration of environmental pollution in major urban centers. Health hazards that such pollutants constitute result in increased health expenditures, with diverse economic and welfare consequences. Also, rapid urban growth poses some frightening negative social consequences. Perhaps, the most notable of them are environmental poverty, quality of life decline and inability to adequately tap into the wealth of human and environmental resources. Therefore, urban poverty promotes a situation where low income urban dwellers are concentrated in rapidly expanding slums, with deplorable housing and social amenities (Onibokun and Kumuyi, 1996; DANIDA, 2000).

Industrialization is another source of environmental hazards in developing as well as developed countries (Dike, 2005). The magnitude of the problems varies from country to country, and depends on the stage of industrial development and the degree of enforcement of environmental regulations. Urban centers are more often the primary recipients of industrial pollution [United Nations Industrial Development Organization (UNIDO), 2004]. Regrettably, existing legislations on the need for environmental impact assessment are being side-tracked due to persistent corruption in the public work force. A development scenario in which social costs of some production activities outweigh the social benefits has been created. Also, rapid industrialization is always accompanied by environmental hazards, which are sometimes beyond what existing technologies can decisively cope with. Government's lapses to respond to these demands often result in poverty, unemployment, inadequate housing facilities, water pollution, air pollution, among others.

This paper addressed two basic research questions. First, what are major environmental hazards that urban households face? Second, what are factors that explain exposure of urban households to environmental hazards? In the remaining parts of the paper, section two discussed the methods of data collection and analytical methods, section three presented the results and discussions, while section four concluded the study with some insights into policy recommendations.

MATERIALS AND METHODS

The study area and methods of data collection

In geographical size, Ibadan is the largest city in Nigeria. The metropolis comprises of five local government areas which are Ibadan North,

Ibadan Northeast, Ibadan Northwest, Ibadan Southeast and Ibadan Southwest local governments. The population these local government areas summed up to 1338659 based on the 2006 National Population Census (National Bureau of Statistics, 2009). Data for the study were obtained from primary sources.

The data were obtained with the aid of well-structured questionnaires administered to households. Stratified sampling technique was employed group the study area into the traditional area, the transitional areas and the elite areas. Simple random sampling was then used to pick equal number of respondents from each of the stratum. The rationale behind the stratification was to ensure equal representation of different classes of people in the selection of the respondents, since the three strata (the traditional, transitional and elite areas) are heterogeneous in terms of settlement pattern and level of planning which are likely to reflect in the socio-economic characteristics of the respondents.

Traditional areas in Ibadan metropolis are places like Beere, Oja Oba, Agugu, Foko, Oje, Idi Arere etc. The transitional area covers place such as Sango, Agbowo, Akobo, Ijokodo, Ashi, Iwo Road etc. while the elite area are well planned areas such as Old Bodija, Agodi G.R.A, Jericho GRA, Onireke, Oluyole extension and so on. For the purpose of this study, 40 households were randomly selected from each of the strata, giving us a total of 120 respondents.

Construction of environmental hazard vulnerability indices and its correlates

Several authors have computed indicators of hazard vulnerability from qualitative or quantitative data, or a combination of these. In this study, environmental hazard vulnerability indices were constructed using information sought on those environmental problems that the households suffer from. Composite vulnerability indices were computed for each of the households, using the factor analysis (FA). The advantage of this aggregation is its ability to extract unique information of vulnerability into a composite index by taking into cognizance their linear combinations with exclusion of any form of collinearity. Four categories of environmental hazards were identified. These are domestic hazards (rodents, insects, bushy environment and illegal structures), air pollutant hazards (noise, dirty air, smoke from refuse burning, kitchen smoke, industrial smoke and bad odour), water pollutant hazards (erosion, flooding and contaminated water) and land pollutant hazards (blockage of drainage systems, traffic congestion and improper waste disposal).

The mathematical expression of FA can be presented as:

$$A_i = f_1(a_{i1} - a_1)/(s_1) + \dots + f_n(a_{in} - a_n)/(s_n) \quad 1$$

$$A_i = \sum_{j=1}^n f_j(a_{ij} - a_j) / s_j \quad 2$$

where A_i is the hazard vulnerability index for each household ($i=1 \dots 120$). Ignoring the time dimension, f_j is the scoring factor for each weather variable ($j=1, \dots, n$), a_{ij} is the j th hazard exposure of i th household ($i, j = 1, \dots, n$), a_j is the mean of i th hazard exposure of households ($j = 1, \dots, n$), s_j is the standard deviation of j th hazard exposure ($j = 1, \dots, n$) and z is the standardized variables. Derived from FA, scoring factors of the first factor component (the efficient component) was used for constructing the hazard vulnerability index of each household. Since all environmental hazard exposure variables are dichotomous and take only a value of zero or one, then the weight is easy to be interpreted. A move from 0 to 1 changes the index by f_j / s_j .

Using the vulnerability index computed by this formula, each household can then be gauged on the extent of vulnerability to environmental hazards, while the indices were also subjected to further parametric analysis using the ordinary least square (OLS) method. This is to explore the correlates of hazard vulnerability by estimating the specified equation:

$$A_i = \eta + \beta_j \sum_{j=1}^8 Z_i + e_i \quad 3$$

With β_j being the estimated parameters, Z_i are the explanatory variables. The explanatory variables are sex of the household head (female =1, 0 otherwise), years of education, household size, private wage employment (yes =1, 0 otherwise), unemployed (yes =1, 0 otherwise), government employment (yes =1, 0 otherwise), income and ownership of house (yes =1, 0 otherwise). Tolerance level was used to address collinearity problem among variables, which resulted in dropping of some highly collinear variables.

RESULTS AND DISCUSSIONS

Socio-economic characteristics of the respondents

Table 1 shows that about 19 percent of the respondents were females. This is in line with cultural norms of the study area, which makes the males breadwinners and head of households. Average age of the respondents is 45.84 years. The variability index of 26.77 percent reveals that there is no much variation in the distribution of respondents' ages. A total of about 33 percent of the respondents were not married, comprising of 15.5 percent singles and 17.5 percent divorcees, widows or widowers. Majority of the heads of households (67 percent) are married. The average household size is 5.42, with coefficient of

variation of 46.86 percent. This implies that high dispersion in the distribution of household size.

Occupational group with highest percentage is government employment (28.3 percent). This, together with the private salaried job (15.8 percent) constitutes 44.1 percent of the entire respondents' occupation. This is typical of any urban center, where people always rely on formal sector. The occupation with second highest frequency is private owned business which is 25 percent, while private salaried job and merchandize are both 15.8 percent unemployed constitute 5.0 percent each, while labour and others not included constitute 0.8 and 3.3 percent respectively.

The average year of education is 12.33, which shows a reasonable literacy level. About 8.3% of the respondents had no formal education, 20 percent spent between 1 and 10 years in school, while 41.7% spent between 16 and 20 years. The disparity in the distribution of respondents by educational status is not so high, considering the coefficient of variation of 45.54%. Also, 56.67% of the respondents owned their dwellings. Average income is N33,941.67k. Income variability is very high with coefficient of variation being 74.33%.

Table 1: Socio-economic characteristics of the respondents

Variable	Mean (%)	Std. Dev.	Coeff. of variation
Gender (female)	(19.16)	0.40	-
Age	45.84	12.27	26.77
Marital status (not married)	32.50	0.47	-
Household size	5.42	2.54	46.81
Own house	(56.67)	0.50	-
Unemployed	(5.00)	0.45	-
Government employment	(28.30)	0.37	-
Private wage	(15.80)	0.44	-
Income	33941.67	25228.47	74.33
Years of education	12.33	5.61	45.54

Environmental sanitation practices and rating

The mode of waste water disposal is an indicator of the level of environmental attitudes and concerns of the households. Table 2 shows the mode of kitchen's waste water disposal of the households. Precisely, 35.8 percent of the households disposed the kitchen waste water properly into septic tanks. However, 13.3 percent discharged kitchen waste water into surrounding gutters, while 44.2 percent poured it in some open spaces.

The mode of bathing water disposal is another measure of environmental attitude and concerns of the households in the study area. Table 3 reveals that 45.8 percent of the households had good environmental practice as far as bathing water

disposal is concerns. These are those whose bathing water was disposed of through septic tanks.

Table 2: Distribution of Respondents by the Mode of Kitchen's waste water disposal

Rating	Frequency	Percentage
Septic tank	43	35.8
Surrounding gutter	16	13.3
Nearby canal	6	5.0
Open space	53	44.2
Others	2	1.7

Table 3: Distribution of Respondents by the Mode of Bathing water Disposal

Mode of Disposal	Frequency	Percentage
Septic tank	55	45.8
Surrounding gutter	15	12.5
Nearby canal	5	4.2
Open space	45	37.5

Table 4: Distribution of Respondents by Methods of Household Refuse Disposal

Mode of Disposal	Frequency	Percentage
Collected	45	37.5
Public Approved dumpsite	16	13.3
Unapproved Dumpsite	56	46.7
Burnt by Households	3	2.5
Others	0	0
Total	120	100.0

Refuse waste disposal and management has been described as the most serious problems in most of the urban centers in Nigeria. For instance per capita solid waste generation in Ibadan was estimated at 0.33kg/day as at 1983, while WHO (2006) reported that Lagos generates 10,000 tones of solid waste daily. The result from this study shows that the method of refuse disposal by most of the households is poor and calls for attention. It is evident from table 4 that 37.5 percent of the households surveyed have their refuse being collected, 16 percent dump theirs at publicly approved dumpsites, 46.7 percent dump refuse indiscriminately in various unapproved dumpsites, while 2.5 percent claims they burn their household refuse. Table 5 further shows that about 54 percent of the respondents were using water closet type of toilet. However, 16.7 percent were using pit latrine toilet, 1.7 percent indicated that they were using public toilet and 27.5 percent admitted to be using nearby bush.

Table 5: Distribution of Respondents by the type of Toilet

Types of toilet	Frequency	Percentage
Water closet	65	54.2
Pit toilet	20	16.7
Public toilet	2	1.7
Nearby bush	33	27.5

Table 6 shows the importance of environmental safety to the respondents. It is evident from the table that environmental safety is very important to majority of the respondents (70 percent). About 25 percent of them indicated that it is fairly important and 1.7 percent affirmed that it was not important. Respondents were also asked to rate the levels of environmental safety in their immediate environment. Only 5 percent rated environmental safety in their immediate environment as being good, 55.8 percent rated their as being fair, whilst 28.3 and 10.8 percent rated the level of environmental safety in their immediate environment as being poor and very poor, respectively.

Table 6: Importance of environmental safety and respondents rating of environmental safety

Degree of Importance of Environmental safety	Frequency	Percentage
Very important	84	70.0
Fairly Important	30	25.0
Not important	2	1.7
Don't know	4	3.3
Rating of environmental safety		
Good	6	5.0
Fair	67	55.8
Poor	34	28.3
Very poor	13	10.8

Environmental problems experienced by respondents

Sixteen most common environmental problems, peculiar to urban environments were selected and the respondents indicated the ones being experienced by their households. Table 7 shows the percentage of respondents that indicated each of the problems as part of environmental problems being experienced in their immediate environment. The problems categorized as domestic pollutants were rodents, insects, bushy environment and illegal constructions being experienced by 61.67 percent, 60.00 percent, 78.33 percent and 59.17 percent, respectively. Unhygienic practices at home often provide breeding grounds for mosquitoes, cockroaches, bed bugs, house flies and rats. These have some associated health challenges like cholera, dysentery, yellow fever, plague and filariasis (Omoleke, 2004). Illegal structures are also common in Ibadan, which had resulted in loss of lives and properties. A very insightful reference is recent flood disaster in the town which wrecked such enormous havocs due to non-compliance with urban housing and planning regulations. Greedy landlords and investors have always circumvent laws and build in questionable places such as along the stream, across drainage system, very close to the road and under high tension cables (ACN, 2011).

Table 7: Environmental problems being experienced by urban households

Variable	Mean
Rodents	61.67
Insects	60.00
Bushy environment	78.33
Illegal structure	59.17
Noise	59.17
Dusty air	62.50
Refuse smoke	65.83
Kitchen smoke	42.50
Industrial smoke	19.17
Bad odour	69.17
Erosion	16.67
Flooding	19.17
Water contamination	11.67
Water drainage blockage	75.00
Traffic congestion	46.67
Improper refuse disposal	72.50

Other notable problems reported are those related to air pollution. These include noise, dusty air, refuse smoke, kitchen smoke, industrial smoke and bad odours. However, 69.17 percent, 65.83 percent and 62.50 percent, respectively are for those that indicated bad odours, refuse some and dusty air respectively. It is important to note that though it is a very important environmental hazard, many Nigerian do not know that they have legal constitution against noise pollution. In Ibadan precisely, hawkers of food and other commodities, vehicular horns, generators and radio cassette players are common sources of pollution. Also, domestic wastes are sometimes burnt within the compound, thereby depriving other neighbours their right to clean air. Similarly, industrial smokes, largely through powering of machines during operations and electricity generating plants are real contributors to air pollution.

Also, erosion problem, flooding and water contamination were reported by 16.67 percent, 19.17 percent and 11.67 percent of the respondents respectively. These problems can be directly linked with blockages of water channels, traffic congestion and improper refuse disposal which were reported by 75.00 percent, 46.67 percent and 72.50 percent of the respondents, respectively. Erosion is the cause of road damages in many Ibadan metropolis. Also, human activities through dumping of refuse in gutters and at the very onset of rainfall are also problematic. Therefore, drainages are blocked and flooding results. Also, due to congestion and lack of adequate planning, some well are dug close to septic tanks. This, along with flooding often leads to water contamination.

Construction of environmental hazard indicators

We constructed four indicators of environmental hazards with specific focus on domestic hazards, air pollutant hazards, water pollutant hazards and land pollutant hazards. The

Factor Analysis results in table 8 shows that the first factor was adequate for use in all the results, accounting for more than 100 percent variance in the results for all hazard groups except domestic hazards. The LR-tests are also statistically significant ($p < 0.01$), except for water pollution hazards that is significant at 10 percent. These results show that the aggregation of the data was fitly done.

Table 8: Eigen value of the factor analysis for each of the environmental hazard groups

Hazard classification	Eigen-value	Explained Variance	LR-test	Chi square
Domestic pollution	1.24086	0.9931	95.71***	
Air pollution	0.8736	1.1906	47.82***	
Water pollution	0.3027	3.0256	6.23*	
Land pollution	0.6677	1.7534	25.51***	

Table 9 further shows the correlation coefficient of the included hazards exposure in the overall prediction of the final indicators. For domestic hazards, exposure to rodents and insects are with highest correlation coefficients with 0.7468 and 0.7357 respectively. Bushy environment has negative parameter. Also, in the group of air pollution hazards, exposure to refuse smoke and kitchen smokes are with highest correlation coefficients with 0.5773 and 0.5415, respectively. Parameters of exposure to industrial smoke and bad odour are with negative sign. Under the water pollution hazards, water contamination has the highest correlation of 0.3451, while flooding is with negatively signed correlation parameter. Blockages of water drainage and improper refuse disposal are with correlation parameters of 0.5436 and 0.5039 respectively under land pollution hazards.

Table 9: Correlation and uniqueness parameters of the factors analysis

Variable	Factor1	Uniqueness
<i>Domestic hazards</i>		
Rodents	0.7468	0.4378
Insects	0.7357	0.4489
Bushy environment	-0.0767	0.7393
Illegal structure	0.3689	0.6718
<i>Air pollution hazards</i>		
Noise	0.3349	0.8484
Dusty air	0.1791	0.8341
Refuse smoke	0.5773	0.6320
Kitchen smoke	0.5415	0.6584
Industrial smoke	-0.2933	0.8998
Bad odour	-0.1298	0.9438
<i>Water pollution hazards</i>		
Erosion	0.2661	0.9292
Flooding	-0.3359	0.8872
Water contamination	0.3451	0.8809
<i>Land pollution hazards</i>		
Water drainage blockage	0.5436	0.7045
Traffic congestion	0.3438	0.8818
Improper refuse disposal	0.5039	0.7461

Table 10 shows the descriptive statistics of the computed composite environmental hazard indicators. It reveals that the mean of domestic hazard (-9.00e-09) is the smallest, while air pollution hazards has the highest value of 9.93e-10. The histogram graphs of the distribution are in figures 1-4

Table 10: Descriptive statistics of computed indicators of environmental hazards

Variable	Mean	Std. Dev.	Minimum	Maximum
Domestic hazards	-9.00e-09	.8264369	-1.228106	.8088478
Air pollution hazards	9.93e-10	.7226099	-1.477281	1.039995
Water pollution hazards	8.69e-10	.4887285	-.7349245	1.339901
Land pollution hazards	-6.21e-09	.6622337	-1.364974	6329107

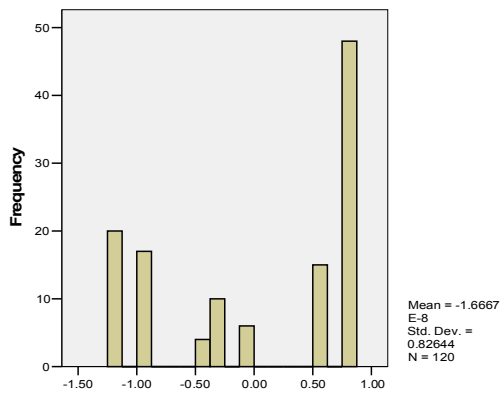

Figure 1: Distribution of domestic hazard's composite indicators

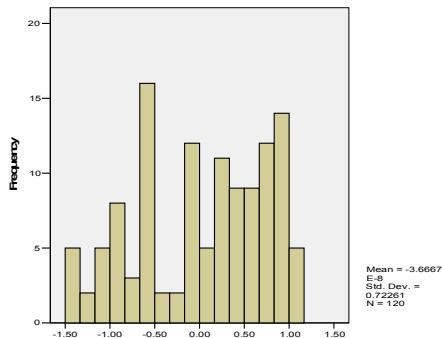

Figure 2: Distribution of air pollution hazard's composite indicators

Tables 11a and 11b contain the results of Ordinary Least Square (OLS) regression analysis of the determinants of environmental hazard exposure. The results show that the models produced good fits of the data, being statistically significant ($p < 0.05$). The variables were also tested for collinearity using the variance inflating factor as provided by STATA

10.0 software. The results show that multicollinearity was not a problem because the least tolerance level is 50.65 percent for female household headship.

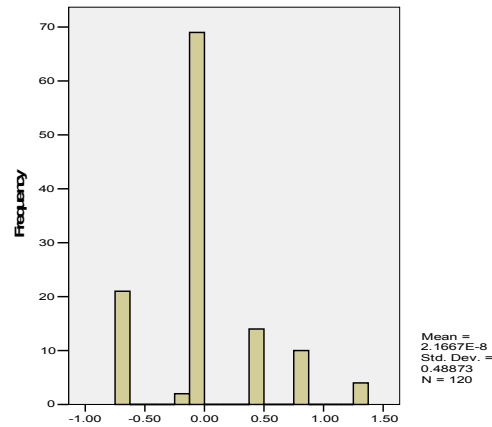

Figure 3: Distribution of water pollution hazard's composite indicators

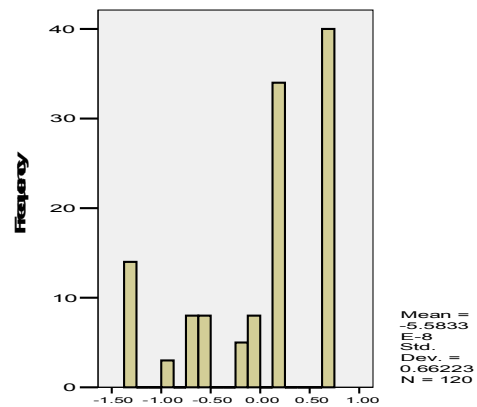

Figure 4: Distribution of land pollution hazard's composite indicators

The parameters of gender for domestic hazard and air pollution hazard models are statistically significant ($p < 0.05$). This shows that female headed households show more vulnerability to domestic and air pollution hazards. This lends credence to assertion by Blaikie *et al* (1994), that gender is one of the social factors subject households to hazard vulnerability. It also buttressed the emphasis of DANIDA (2000) and Commission on the Status of Women (2009) that female headed households' deprivation in access to production resources always exposes them to hazard vulnerability.

Table 11a: Determinants of environmental health hazard exposure

Variables	Coefficient	t-statistics	Coefficient	t-statistics	Tolerance
	Domestic Hazards		Air Pollution Hazards		
Gender	.3509688**	2.05	.3339494**	1.99	0.506493
Household size	.0808637**	2.34	.0480628	1.41	0.562668
Own house	.2636106*	1.72	.2282969	1.52	0.585297
Unemployed	.4097978**	2.29	-.1365625	-0.78	0.593947
Government employment	.0968275	0.45	-.2150125	-1.01	0.615970
Private wage	-.299351	-1.61	-.0385359	-0.21	0.648586
Income	-.0000121***	-3.95	-4.29e-06	-1.42	0.673265
Years of education	-.0236339	-1.59	-.0212992	-1.46	0.854135
Constant	-.1834356	-0.48	.0961446	0.26	
F-value	8.05***		3.43***		
Adj R-Square	0.3216		0.1405		

Note : *** Statistically significant at 1 percent, ** Statistically significant at 5 percent, * Statistically significant at 10 percent

Table 11b: Determinants of environmental health hazard exposure

Variables	Coefficient	t-statistics	Coefficient	t-statistics	Tolerance
	Water Pollution Hazards		Land Pollution Hazards		
Gender	.0410405	0.35	-.0065889	-0.04	0.506493
Household size	.0167167	0.70	.1066386**	3.37	0.562668
Own house	.026558	0.25	.3280707**	2.34	0.585297
Unemployed	.312867**	2.54	-.2698662*	-1.65	0.593947
Government employment	-.0604936	-0.40	-.0458773	-0.23	0.615970
Private wage	.0001358	0.00	.107036	0.63	0.648586
Income	-4.41e-06**	-2.08	-3.35e-06	-1.19	0.673265
Years of education	.0340778***	3.34	.0037965	0.28	0.854135
Constant	-.5985719**	-2.28	-.5224706	-1.50	
F-value	2.26**		2.91***		
Adj R-Square	0.0783		0.1138		

Note : *** Statistically significant at 1 percent, ** Statistically significant at 5 percent, * Statistically significant at 10 percent

Household size variable parameters are with positive sign and statistically significant for domestic hazard and land pollution hazard models. The results imply that increasing household size by one unit will increase indicators of domestic hazard and land pollution hazards by 0.0809 and 0.1066, respectively. These results are in line with submissions by Inyang (1997) that environmental hazard exposure is directly related to population density. Therefore, when the house is overcrowding, there are tendencies of having too many things packed in small rooms, which can easily serve as breeding ground for pests and rodents. Households with many members are also going to generate a lot of kitchen wastes and disposal may be a problem, depending on house location. The parameters of ownership of house variable for domestic hazards and land pollution hazards are with positive sign and statistically significant ($p < 0.10$). These show that those that owned the houses where they were resident have higher exposure to land pollution and domestic hazards.

Being unemployed also significantly increased ($p < 0.05$) vulnerability to environmental hazard exposures (domestic and water pollution hazards). This may result from poverty that is expected to be associated with unemployment. Our results can be buttressed by the assertion of Onibokun and Kumuyi (1996) that urban poverty promotes environmental hazard exposure because the poor cannot afford accommodation in a decent environment. It should also be noted that the parameters of income variable in all the models are with negative sign but statistically significant domestic hazard and water pollution hazard exposure ($p < 0.01$). The results confirm the findings of Onibokun and Kumuyi (1996), Adger (1996) and DANIDA (2000) that poverty or low income is directly associated with environmental hazard exposures. However, the parameter of education variable is positive and statistically significant for water pollution hazard model. This is contrary to our expectation and implies that as household heads' years of education increases by one unit, indicator of

water pollution hazard significantly increases by 0.0340.

RECOMMENDATIONS

Environmental safety is a prerequisite for healthy living and socio-economic development of any nation. Without it, economic development will be compromised and households resources will not be optimally utilized. Given the findings from this study, some issues should be addressed by policy makers. First, there is need to initiate community based self-help efforts in provision of certain amenities such as toilets, drainages, dumpsites and refuse evacuation facilities. This is highly needed in those areas that are not well planned (traditional areas) where people live under deplorable environmental condition. These people, being largely poor need government's assistance in evacuating their domestic wastes for ensuring environmental safety.

Second, relevant government agencies should enforce provision of certain environmental amenities by individuals building houses in all the existing and newly developed areas. These include safe toilets, septic tanks and drainage system. Similarly, efforts should be made to ensure effective sanitary inspections and monitoring of environmental practices of people. This can be effectively achieved through enforcement of existing environmental laws by appropriate government agencies.

There is also the need to enact laws to protect citizens from externalities resulting from activities of some other players in the society. These may include restrictions on noise pollution whether in markets or at home, restrictions on refuse burning, mandatory compliance with urban house planning and regulations.

References

1. ACN. Ibadan Flood: Ajimobi gives quit notice to owners of illegal structures. 2011. Internet file retrieved on 23rd July 2012 from <http://actioncongressnigeria.org/2011/09/01/ibadan-flood-ajimobi-gives-quit-notice-to-owners-of-illegal-structures/>
2. Adger WN. An assessment of vulnerability to climate change in Xuan Thuy, Vietnam. Unpublished paper, CSERGE, University of East Anglia and University College London. 1996
3. Alabi M. Waste products' survey for identification and quantification of different wastes generated in Nigeria. Unpublished PhD Thesis in the Dept of Geography, University of Ibadan. 2004
4. Ayedun CA, Durodola OD, Akinjare OA. Towards ensuring sustainable urban growth and development in Nigeria: challenges and strategies. *Business Management Dynamics* 1(2):99-104, 2011.
5. Blaikie P, Cannon T, Davies I, Wisner B. *At risk – natural hazards, people's vulnerability, and disasters*, London: Routledge. 1994
6. DANIDA. Who suffers? Identifying the vulnerable groups. Extracted from DANIDA workshop papers: improving the urban environment and reducing poverty. December 5, 2000; Copenhagen, Denmark. Internet file retrieved on 24th July 2012 from <http://web.mit.edu/urbanupgrading/urbanenvironment/issues/vulnerable-groups.html>
7. Dike AA. Environmental Problems in third World Cities :A Nigerian Example. *Journal of Current Anthropology* 26(4):501-505. 1985
8. Ekundare O. An economic history of Nigeria, 1860-1960 Africana Pub. Co., Jun 1, 1973, 458 pages.
9. Falade JB. Public acquisition of land for landscaping and open space management. *Journal of the Nigeria Institute of Town Planners*, 11: 1-13. 1998
10. Inyang PER. Urbanization process and problems in Nigeria. Final Report; NISER. 1997
11. National Bureau of Statistics (NBS). Annual Abstract of Statistics 2009. Abuja. 2009.
12. Omoleke II. Management of environmental pollution in Ibadan, An African city: The challenges of health hazard facing government and the people. *J. Hum. Ecol.*, 15(4): 265-275. 2004
13. Onibokun AG, Kumuyi AJ. Urban poverty in Nigeria: towards sustainable strategies for its alleviation. Centre for African Settlement Studies and Development, Ibadan, Nigeria." CASSAD Monograph Series 10. pp. 1–2, 1996.
14. Ujoh F, kwabe ID, Ifatimehin OO. Understanding urban sprawl in the Federal Capital City, Abuja: Towards sustainable urbanization in Nigeria. *Journal of Geography and Regional Planning* 3(5):106-113, 2010.
15. UNIDO. The industrial development report 2004. industrialization, environment and the Millennium Development Goals in Sub-Saharan Africa: the new frontier in the fight against poverty. Vienna: United Nations Industrial Development Organization. 2004
16. WHO. Health of the People. The African Regional Health Report, 2006.

10/27/2012

Linearization Algorithms for a Level and PH Process

Subbulekshmi¹, Kanakaraj²

¹ Corresponding Author, Dept of Instrumentation and control systems Engineering, PSG College of Technology, Coimbatore, Tamilnadu, India

² Dept of Electrical and Electronics Engineering, PSG College of Technology, Coimbatore, Tamilnadu, India
dslsubbu03@yahoo.com

Abstract: The aim of this work is to keep the interacting liquid level and pH parameter at a desired value. This article presents Kravari's decoupling and linearization algorithm and Generic Model Control (GMC) and Hirschorn's algorithms for an approximated model of interacting level and pH process. The comparison with the above algorithms is shown. Control laws obtained from the above algorithms are relatively simple and accurate. These algorithms make the closed loop system linear in an input-output sense. Simulations are carried out using PI, PI-SPW (Set point Weighting), Fuzzy Logic Controller (FLC) and Model Predictive Control (MPC). Control performance of a Hirschorn's with MPC is found to be better. The control laws obtained for Hirschorn's algorithm gives improved Settling Time (Ts) and Integral Square Error (ISE).

[Subbulekshmi, Kanakaraj. **Linearization Algorithms for a Level and PH Process.** *Life Sci J* 2012;9(4):2528-2533]. (ISSN: 1097-8135). <http://www.lifesciencesite.com>. 374

Keywords: Decoupling, Multivariable, Interacting, GMC, Hirschorn's Algorithm

1. Introduction

The nonlinear, strongly interacting nature of multivariable chemical processes necessitates the development of solid control methodologies that are capable of coping with both nonlinearities and interactions (Chung et al., 2007).

In this work for a process with significant nonlinearities, the linear analysis is valid only in an infinitesimally small neighborhood of the operating point. Here three decoupling and linearization state feedback laws are applied to an interacting nonlinear level and pH process. An external linear conventional decentralized PI controller is implemented in the above mentioned level and pH process (Ahsene et al., 2012).

Control of pH is important in the chemical industry especially in waste water treatment. However pH processes are difficult to control due to their nonlinear dynamics (Alexd et al., 2005). In a chemical process involving the mixing of reaching streams (acid, base, salts), the pH is a measure of the hydrogen ion concentration, that determines the acidity / alkaline of a solution (Yoon et al., 2005).

This work is concerned with the comparison of a three linearization algorithms for the synthesis of the nonlinear controller for multivariable interacting nonlinear level and pH process that makes the system linear (Crespo and Sun., 2004).

The Hirschorn's algorithm is found to be most accurate and efficient as in presented comparison. Decoupling and linearization algorithm and GMC needs some further model refinement but also give acceptable results. The aim of this article is to evaluate the comparison between performance of

Hirschorn's algorithm, decoupling and linearization and GMC algorithms based on approximated model as a possible approach to control in real world installations.

In this paper is a brief description of the basics of decoupling and linearization algorithm. Further the available literature is also surveyed in this section. Then deals with the liquid level and pH process. Next describes the basis of Kravari's algorithm. Also describes the basis of GMC algorithm. Then describes the basis of Hirschorn's algorithm. Presents the simulation results with decoupling algorithms along with PI, PI-SPW, FLC, MPC controller such as Kravari's, GMC and Hirschorn's are presented after the application to the model.

2. Material and Methods

General Formulation of the MIMO System

Consider an open loop stable multivariable system with n-inputs and n-outputs as shown in Figure 1. In this process two of the controlled outputs and manipulated inputs are shown in Figure 2. It has the following two control loops. Liquid level and pH coupling with acid flow rate u_1 and base flow rate u_2 . Where r_i , $i=1, \dots, n$ are the reference inputs; u_i , $i=1, \dots, n$ are the manipulated variables; y_i , $i=1, \dots, n$ are the system outputs $G(s)$ and $G_c(s)$ are process transfer function matrix and full dimensional controller matrix with compatible dimensions, expressed by

$$G(s) = \begin{bmatrix} g_{11s} & g_{12s} & \dots & g_{1ns} \\ g_{21s} & g_{22s} & \dots & g_{2ns} \\ \dots & \dots & \dots & \dots \\ g_{n1s} & g_{n2s} & \dots & g_{nns} \end{bmatrix} \text{ and}$$

$$G_c(s) = \begin{bmatrix} g_{c11s} & g_{c12s} & \dots & g_{c1ns} \\ g_{c21s} & g_{c22s} & \dots & g_{c2ns} \\ \dots & \dots & \dots & \dots \\ g_{cn1s} & g_{cn2s} & \dots & g_{cnns} \end{bmatrix}$$

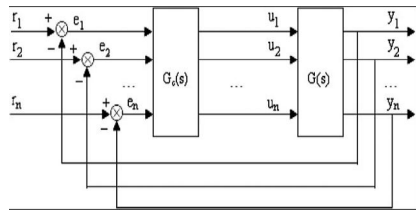

Figure 1 Closed loop multivariable control system
We consider the nonlinear systems with equal number of inputs and outputs of the form

$$\dot{x} = f(x) + \sum_{j=1}^m g_j(x) u_j \tag{1}$$

$$y_i = h_i(x), i = 1, 2, \dots, m \tag{2}$$

Where

$$u = \begin{bmatrix} u_1 \\ \vdots \\ u_m \end{bmatrix} \in \mathbb{R}^m, \quad y = \begin{bmatrix} y_1 \\ \vdots \\ y_m \end{bmatrix} \in \mathbb{R}^m, \quad x = \begin{bmatrix} x_1 \\ \vdots \\ x_n \end{bmatrix} \in \mathbb{R}^n$$

$f(x)$ is a smooth vector field on \mathbb{R}^n , $g_1(x), \dots, g_m(x)$ are smooth vector fields on \mathbb{R}^n , $h_1(x), \dots, h_m(x)$ are smooth scalar fields on \mathbb{R}^n and $m < n$. This is a comparison of linearization algorithms like kravaris decoupling and linearization, GMC, Hirschorn's algorithm.

Level and pH process

A neutralization reaction process, which is schematically shown in Figure 2. A strong acid (HCL) at a concentration of CAO and a strong base (NaOH) at a concentration CBO is also studied (Kravaris and Chung, 1991). This process is nonlinear and an interaction also exists between the parameters. The aim of this control process is to keep the liquid level and the pH at desired values. It is an established fact that this control problem is challenging when the set point is near the point of neutrality, even if the control system is a SISO. The aim of the control is to keep the liquid level and the pH in the tank at the desired values. Y_1 is a level sensor output and Y_2 is a pH sensor output. As level and pH depends on u_1 (feed flow rate of acid) and u_2 (feed flow rate of base). It is clear, however that an interaction exists in this process.

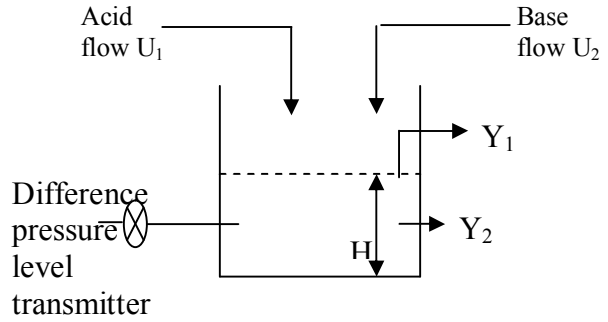

Figure 2 Schematic Diagram for the level and pH control process. (a) u_1 is the feed flow rate of acid (b) u_2 is the feed flow rate of base (c) Y_1 is the level sensor output (d) Y_2 is the pH sensor output. (e) H is the height of the liquid.

The process model under the appropriate assumptions is given by

$$\dot{x}_1 = \left(\frac{-k}{s} \right) x_1^{1/2} + \frac{1}{s} (u_1 + u_2) \tag{3}$$

$$\dot{x}_2 = \left[\frac{-1}{s x_1 \log_{10}(a)} \right] [(b - CAO)U_1 + (b + CBO)U_2] \tag{4}$$

Where $b = -10^{x_2-14} + 10^{-x_2}$,
 $a = 10^{x_2-14} + 10^{-x_2}$

Output equation is given by

$$y_1 = x_1$$

$$y_2 = x_2$$

Here x_1 and x_2 are the liquid level and the values of pH respectively. u_1 and u_2 are feed flow rate of strong acid and strong base respectively. The tank is a stirred column of 75 cm height and 15.6 cm diameter. A strong acid (HCL) is at a concentration CAO and strong base (NaOH) is at concentration CBO. The aim of this control process is to keep the liquid level and the pH at the desired values. It is known that this control problem is very difficult when the setpoint is nearer to the point of neutrality. The values 's' and 'k' are cross sectional area of the tank 191cm² and constant coefficient 1.8cm^{5/2}s⁻¹ respectively. The feed concentrations are CAO=CBO =0.03mol cm³. The feed rates are constrained as $0 \leq u_1, u_2 \leq 22 \text{cm}^3 \text{ s}^{-1}$.

Development of Non-Interacting Control Law

A non-interacting feedback control law is given by (Kravaris and Chung, 1991)

$$\begin{bmatrix} u_1(x) \\ u_2(x) \end{bmatrix} = \alpha_i(x) + \beta_{ij}(x) \begin{bmatrix} \gamma_1 \\ \gamma_2 \end{bmatrix} \tag{5}$$

$$(i = 1, 2; j = 1, 2)$$

where $\gamma_1(x)$ and $\gamma_2(x)$ are new inputs.

According to Kravari's decoupling and linearization control theory, control of control law u_1 and u_2 are taken as

$$u_1 = \frac{S(b+CBO)}{(Cao+CBO)} \left[\left(\frac{k}{S}\right)x_1^{1/2} - \zeta_{10}x_1 + V_1 \right] + \frac{Sx_1 \log_{10}(a)}{(CAO+CBO)} [-\zeta_{20}x_2 + V_2] \quad (6)$$

$$u_2 = \frac{S(b-CAO)}{(CAO+CBO)} \left[-\left(\frac{k}{S}\right)x_1^{1/2} + \zeta_{10}V_1 \right] + \frac{Sx_1 \log_{10}(a)}{(CAO+CBO)} [\zeta_{20}x_2 - V_2] \quad (7)$$

Substituting u_1 and u_2 in the state model, results in state equation being in decoupled form and linearized form. Before applying this algorithm, liquid level Y_1 depends on u_1 and liquid pH Y_2 depends on u_1 and u_2 . But now it is decoupled and interaction is eliminated.

$$\begin{aligned} \dot{x}_1 &= -\delta_{10}x_1 + v_1 \\ \dot{x}_2 &= -\delta_{20}x_2 + v_2 \end{aligned}$$

Where v_1 and v_2 are new control inputs. x_1 is liquid level x_2 is liquid pH value. $\delta_{10}=\delta_{20}$ is constant coefficients.

Development of GMC Control Law

The main objective of GMC is to guide a system from its initial condition to a desired setpoint by manipulating its input so that the system follows the behavior of a predefined reference model. A reference model is specified for y_1 and y_2 , according to the GMC formulation. Find a control law, such that y is equal to Y_{sp} .

$$\begin{aligned} \begin{bmatrix} \dot{y}_1 \\ \dot{y}_2 \end{bmatrix} &= \begin{bmatrix} K_{11} & 0 \\ 0 & K_{12} \end{bmatrix} \begin{bmatrix} y_{1sp}-y_1 \\ y_{2sp}-y_2 \end{bmatrix} + \\ \int \begin{bmatrix} K_{21} & 0 \\ 0 & K_{22} \end{bmatrix} \begin{bmatrix} y_{1sp}-y_1 \\ y_{2sp}-y_2 \end{bmatrix} dt \end{aligned} \quad (8)$$

GMC is mainly used to compensate for model errors and update the model parameters at steady-state as it is very difficult to determine the steady state case. GMC is a multivariable controller with interactions between variables taken into account in the calculation of the values and of the manipulated variables. For a same model GMC algorithm is also included.

According to GMC algorithm control theory, control law U_1 and U_2 taken as

$$u_1 = SV_1 + kx_1^{1/2} - \frac{[Sx_1 \log_{10}(a)V_2 - bSV_1 - bkx_1^{1/2} + CAOSV_1 + CAOKx_1^{1/2}]}{(CAO+CBO)} \quad (9)$$

$$u_2 = \frac{[Sx_1 \log_{10}(a)V_2 - b(SV_1 + kx_1^{1/2}) + CAO(SV_1 + kx_1^{1/2})]}{(CAO+CBO)} \quad (10)$$

Substituting u_1 and u_2 in the state model, results in state equation being in decoupled form and linearized form. Before applying this algorithm, liquid level Y_1 depends on u_1 and liquid pH Y_2

depends on u_1 and u_2 . But now x_2 depends on u_1 and u_2 .

$$\begin{aligned} \dot{x}_1 &= \left(\frac{-k}{S}\right)x_1^{1/2} + \frac{1}{S} \left[\frac{(SV_1 + kx_1^{1/2})(2CAO + bCAO + CBO)}{CAO + CBO} \right] \\ \dot{x}_2 &= \frac{1}{CAO + CBO} \left[\begin{aligned} &b(SV_1 + kx_1^{1/2})(2CAO + CBO + bCAO - b) - \\ &CAO(Sx_1 + kx_1^{1/2})[CAO + CBO + b + bCAO] \\ &(CBO - b)Sx_1 \log_{10}(a)v_2 + (SV_1 + kx_1^{1/2})(CAO - b) \end{aligned} \right] \end{aligned}$$

So interaction exists even after implementing GMC algorithm in the process.

Development of Hirschorn's Control Law

A derivative function h along a vector field f is called a lie derive, denoted by

$$L_f h(x) = \frac{\partial}{\partial x} h(x) f(x) \quad \text{Note that } \frac{\partial h}{\partial x} \text{ is a } (1,n) \text{ row vector and } f(n,1) \text{ column vector.}$$

If h and f are smooth mapping, the differentiate along the same or another vector field can be repeated, for example the twice repeated lie derivative along f is written as the function $L_f(L_f h(x)) = L_f^2 h(x)$, for $k \geq 1$, repeated lie derivative notation is

$$L_f^k h(x) = L_f(L_f^{k-1} h(x)) \quad (11)$$

$$L_f^0 h(x) = h(x) \quad (12)$$

Consider the non-linear system (3 &4), taking the time derivative of the each output component, $Y_i=h_i(x)$, the smallest order of each output derivative that explicitly depends on the input u , as the relative degree ζ_i .

$$\dot{y}_i = \frac{dh_i}{dt} = \frac{dh_i}{dx} \frac{dx}{dt} = L_f h_i(x) \quad (13)$$

$$\ddot{y}_i = L_f^2 h_i(x) \quad (14)$$

$$y_i^{(\zeta_i)} = L_f^{\zeta_i} h_i(x) + L_g L_f^{\zeta_i-1} h_i(x) u$$

where $L_g L_f^{\zeta_i-1} h_i(x) u$ denotes the $(1,m)$ row vector with the j^{th} component $L_{g_j} L_f^{\zeta_i-1} h_i(x)$. The purpose of the differentiation is to obtain an explicit expression for the control input u .

In Hirschorn's algorithm, $\zeta^{(k^*)} = m$,

$F_l(k) = \text{constant}$, $l=0, \dots, k^*-1$. Furthermore, given by $m \times 1$ matrices β_{ik} , $i=0, \dots, m$, $k=0, \dots, r_i-1$ and an $m \times m$ invertible matrix Γ . The state feedback (Kravaris and Soroush, 1990)

$$u = \left[\Gamma L_g H^{(k^*)}(x) \right]^{-1} \left\{ V - \sum_{i=1}^m \sum_{k=0}^{r_i-1} \beta_{ik} L_r^k h_i(x) - \sum_{l=0}^{k^*-1} \gamma_l [F_l : I_m - \zeta^{(l)}] E_l L_r H^{(k^*)}(x) \right\} \quad (15)$$

where $H^0(x) = \begin{bmatrix} L_r^{r_1-1} h_1(x) \\ \vdots \\ L_r^{r_m-1} h_m(x) \end{bmatrix}$

$$\zeta^{(0)} = \text{Rank} [L_g H^0(x)] \quad (16)$$

$k=0, 1, 2, \dots$

Rearrange the rows of $L_g H^{(k)}(x)$ so that the first $\zeta^{(k)}$ rows are linearly independent and denote by E_k , the corresponding elementary matrix that performs this row rearrangement. Find a $(m - \zeta^{(k)}) \times \zeta^{(k)}$ matrix $F_k(x)$ such that $[F_k(x) : I_m - \zeta^{(k)}] E_k L_g H^{(k)}(x) = 0$. Where $I_m - \zeta^{(k)}$ denotes the $(m - \zeta^{(k)}) \times (m - \zeta^{(k)})$ identity matrix, define

$$H^{(k+1)}(x) = \begin{bmatrix} \text{first } \zeta^{(k)} \text{ rows of } E_k H^{(k)}(x) \\ [F_k : I_m - \zeta^{(k)}] E_k H^{(k)}(x) \end{bmatrix} \quad (17)$$

$$\zeta^{(k+1)} = \text{Rank} [L_g H^{(k+1)}(x)] \quad (18)$$

following the steps of the algorithm, a sequence of non negative integers $0 \leq \zeta^{(0)} \leq \zeta^{(1)} \leq \zeta^{(2)} \leq \dots \leq \zeta^{(k^*)} \leq \dots \leq m$. Thus there is a least positive integer k^* such that $\zeta^{(k^*)}$ is maximal. In other words, the algorithm will always terminate after a finite number of steps equal to k^* , and at the last step, one will either have $\zeta^{(k^*)} = m$.

The Hirschorn's control algorithm based on non-linear feedback transformation is applied to a non-linear interactive level and pH process.

$$u_1 = \frac{S}{(CAO + CBO)} [bV_1 - b\zeta_{10}x_1 + b\frac{k}{s}x_1^{1/2} - \frac{bk^2}{2S^2} + CBOV_1 - CBO\zeta_{10}x_1 + CBO\frac{k}{s}x_1^{1/2} - CBO\frac{k^2}{2S^2} + x_1 \log_{10}(a)V_2 - x_1 \log_{10}(a)\zeta_{20}x_2] \quad (19)$$

$$u_2 = \frac{S}{(CBO + CBO)} [-bV_1 + b\zeta_{10}x_1 - b\frac{k}{s}x_1^{1/2} + \frac{bk^2}{2S^2} + CBOV_1 - CAO\zeta_{10}x_1 + CAO\frac{k}{s}x_1^{1/2} - CAO\frac{k^2}{2S^2} - x_1 \log_{10}(a)V_2 + x_1 \log_{10}(a)\zeta_{20}x_2] \quad (20)$$

Substituting u_1 and u_2 in the state model, results in state equation being in decoupled form and linearized form. Before applying this algorithm, liquid level Y_1 depends on u_1 and liquid pH Y_2 depends on u_1 and u_2 . But now it is decoupled and interaction is eliminated.

$$\begin{aligned} \dot{x}_1 &= v_1 - \delta_{10}x_1 - \frac{k^2}{2S^2} \\ \dot{x}_2 &= v_2 - \delta_{20}x_2 \end{aligned}$$

Where v_1 and v_2 are new control inputs. x_1 is liquid level x_2 is liquid pH. $\delta_{10} = \delta_{20}$ is constant coefficients.

3. Results

At first, PI controller is added for level and pH process along with the decoupling Kravaris algorithm. It is reproduced in Figure 3. It shows that the output response of the level and pH when the set point of the level is changed from 1 to 30cm and pH from 1 to 4. The sudden disturbance introduced at time of 200 sec in level is not affecting the pH process.

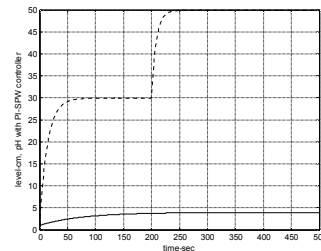

Figure 3 Process with decoupling (Kravaris) with PI controller for level and pH process

Next PI-SPW controller is added along with the decoupling Kravaris algorithm. It is reproduced in Figure 4. The sudden disturbance introduced at time of 200 sec in level is not affecting the pH process. It can be seen from the figure that the influence of the control performance is improved compared to Figure 3.

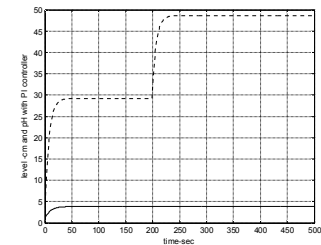

Figure 4. Process with decoupling (Kravaris) with PI-SPW controller for level and pH process

Then FLC controller is added along with the decoupling kravaris algorithm. It is reproduced in Figure 5. The sudden disturbance introduced at time of 200 sec in level is not affecting the pH process. It can be seen from the figure that the influence of the control performance improved when compared to Figure 4.

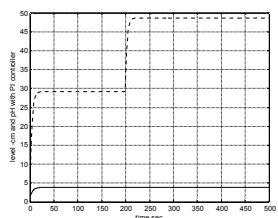

Figure 5 Process with decoupling (kravaris) with FLC controller for level and pH process

Next applying GMC algorithm with external PI controller is shown in Figure 6. It shows the output response of the level and pH when the set point of the level is raised from 1 to 30cm and pH from 1 to 4. The sudden disturbance introduced at time of 200sec in level is not affecting the pH process. It can be seen from the figure that under the influence of the controller performance, ISE is improved.

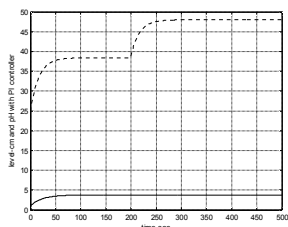

Figure 6 Process with decoupling (GMC) with PI controller for level and pH process

Next GMC algorithm with external PI set point weighting controller is shown in Figure 7. The sudden disturbance introduced at time of 200sec in level does not affect the pH process. It can be seen from the figure that the ISE is improved than Figure 6.

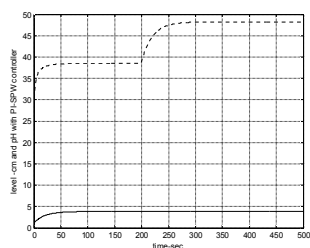

Figure 7 Process with decoupling (GMC) with PI-SPW controller for level and pH process

Then decoupling and linearization with external Fuzzy logic controller is added as shown in Figure 8. The sudden disturbance introduced at time

of 200sec in level was not affecting the pH process. It can be seen from the figure that the influence of the control performance improved where compared to Figure 7.

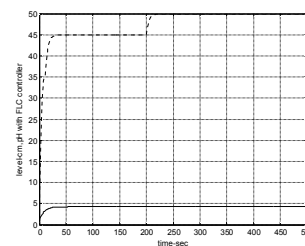

Figure 8 Process with decoupling (GMC) with FLC controller for level and pH process

Level pH control experiment with PI controller is carried out with the Hirchorn's algorithm. The result is shown in Figure 9 (Weijie et al 2009). It shows the output response of the level and temperature when the set point of the level is changed from 1 to 30cm and pH from 1 to 4. The sudden disturbance introduced at time of 200sec in level is not affecting the temperature process. It can be seen from the figure that under the influence of the controller performance, ISE is also improved

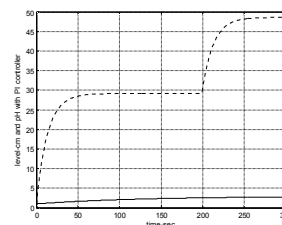

Figure 9 Process with decoupling (Hirchorn's) with PI controller for level and pH process

Next level and pH control experiment with PI-SPW controller is carried out with the Hirchorn's algorithm. The output response is shown in Figure 10. It can be seen from the figure that the control performance is improved when compared to Figure 9.

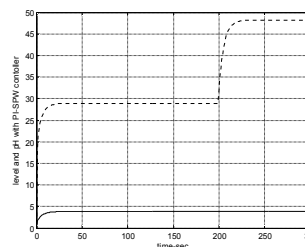

Figure 10 Process with decoupling (Hirchorn's) with PI-SPW controller for level and pH process

Then the level and pH control experiment with MPC controller is carried out with the Hirchorn's algorithm. The corresponding output is shown in Figure 11. It can be seen from the figure

that the control performance is improved when compared to Figure 10.

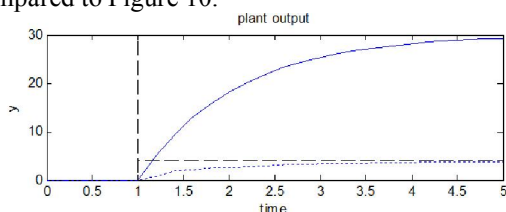

Figure 11 Process with decoupling (Hirchorn's) with MPC controller for level and pH process

4. Discussions

Table 1. Comparison of controller performance (Kravaris algorithm)

	Process	Ts(sec)	ISE
PI	Level	80	1.096e+004
	pH	80	165.58
PI-SPW	Level	50	5.935e+004
	pH	50	142.197
FLC	Level	30	3.338e+003
	pH	40	49.5

Table 1 shows the performance of Level pH process with controllers. It is inferred that FLC controller gives less Settling time (Ts) and Integral Square Error (ISE) for both the process to reach the desired set point.

Table 2. Comparison of controller performance (GMC algorithm)

	Process	Ts(sec)	ISE
PI	Level	80	Interaction exists
	pH	80	Interaction exists
PI-SPW	Level	50	Interaction exists
	pH	50	Interaction exists
FLC	Level	30	Interaction exists
	pH	30	Interaction exists

GMC is not suitable for the Level pH process. Interaction exists even after implementing GMC algorithm in the process.

Table 3. Comparison of controller performance (Hirchorn's algorithm)

Hirchorn's		Ts (sec)	ISE
PI	level	50	6.419e+003
	pH	50	585.07
PI-SPW	level	25	1.352e+003
	pH	25	30.79
MPC	level	3	25
	pH	4	25

Table 3 shows the performance of Level pH process with controllers. It is inferred that MPC controller gives less Settling time (Ts) and Integral Square Error (ISE) for both the process to reach the desired set point.

This work concerns the comparison of control laws of a linearization algorithms for the synthesis of controllers for multivariable nonlinear processes that makes the level and pH system linear. Hirchorn's linearization feedback algorithm is most accurate and efficient in the comparison. Decoupling and linearization feedback control law and GMC needs further model simulation. They too give acceptable results. This paper reports the simulation application of the Hirchorn's control law, Decoupling and linearization feedback control law and GMC control law to the chemical process, (level and pH control process). Results of these simulations are presented in Table 1. This includes that Hirschorns algorithm with PI controller gives less Settling time and Integral Square Error for both level and pH parameter.

Acknowledgements:

The authors would like to thank all colleagues and students who contributed to this study.

Corresponding Author:

D. Subbulekshmi
Department of I&CE,
PSG College of Technology,
Coimbatore, Tamilnadu, India.
E-mail: dsl@ice.psgtech.ac.in

References

- Ahsene Boubakir, Salim Labiod, Fares Boudjema. A stable self-tuning proportional-integral-derivative controller for a class of multi-input multi-output nonlinear systems. *Journal of Vibration and Control* 2012; 18 (2):228-39.
- Alexd.Kalafatis, Liuping Wang, William R. Cluett. Linearizing feedforward- feedback control of pH processes based on the Wiener model. *Journal of Process Control* 2005; 15:103-12.
- Chung-Cheng Chen, Yen-Feng Lin, Ming-Huang Chen, Nonlinear Tracking with Almost Disturbance Decoupling and Its Application to Ball and Beam System. *Journal of the Chinese Institute of Engineers* 2007; 30 (3), 545-51.
- Crespo L.G and Sun J.Q. On the Feedback Linearization of the Lorenz System. *Journal of Vibration and Control* 2004; 10 (1), 85-100.
- Jenn-Yih Chen, Wen-Jieh Wang. A new Sliding Mode Position Controller for the Induction Motor Using Feedback Linearization. *Journal of the Chinese Institute of Engineers* 1998; 121 (2), 211-19.
- Kravaris, C, Chung, C.B. Multivariable control experiments of non-linear chemical process using non-linear feedback transformation. *AIChE J* 1991; 33, 592-98.
- Kravaris, C, Soroush, M. Synthesis and multivariable non-linear controllers by input / output linearization. *AIChE J* 1990; 36, 249-64.
- Weijie Wang, Donghai Li, Yali Xeu. Decentralised two degree of freedom PID tuning method for MIMO processes. *IEEE conference on Industrial Electronics* 2009; 143-148.
- Yoon S.S, Yoon T.W, Yang, D.R, Kang, T.S. Indirect adaptive non linear control of a pH process. *Computers and Chemical Engineering* 2005; 26, 1223-30.

31/10/2012

Depressive disorder among brucellosis patients in Hamadan, Iran: A case-control study

Peyman Eini MD¹ (Corresponding author), Mohammad Mehdi Majzoobi MD¹, Mohammad Ahmadpanah², Mojgan Mamani MD³

¹. Assistant Professor, Department of Infectious Diseases, Hamadan University of Medical Sciences, Hamadan, Iran.

². Assistant Professor, Department of Psychiatry, Hamadan University of Medical Sciences, Hamadan, Iran.

³. Associate Professor, Department of Infectious Diseases, Hamadan University of Medical Sciences, Hamadan, Iran.

Abstract: Objectives: The aim of this study was to determine the prevalence of depressive disorder among brucellosis patient attending to the central university hospital in Hamadan, Iran. **Methods:** In this case-control study, the rate of depression was compared between 100 brucellosis patients as cases and 71 healthy controls. The depression was assessed with Zung Depression Scale and confirmed by a clinical psychologist. **Results:** The prevalence of depression in case and control group was 53% and 16.9%, respectively ($P < 0.001$). **Conclusion:** Iran is an endemic region for *Brucella* infection and there is a high rate of depression among brucellosis patients. Physicians should pay more attention to behavioral disorders in high risk patients with unexplained neurologic symptoms to rule out the infectious nature of such diseases.

[Peyman Eini, Mohammad Mehdi Majzoobi, Mohammad Ahmadpanah, Mojgan Mamani. **Depressive disorder among brucellosis patients in Hamadan, Iran: A case-control study.** *Life Sci J* 2012; 9(4):2534-2537]. (ISSN: 1097-8135). <http://www.lifesciencesite.com>. 375

Keywords: brucellosis, depression, Hamadan

Introduction

Human brucellosis is the major zoonotic infectious diseases with a worldwide distribution and still remains as a serious public health problem in many countries, especially, where the animal health care programs are poor (1,2). Patients with *Brucella* infection may present various clinical features with involvement of all organs of the body including reticuloendothelial system, hematologic system, central nervous system (CNS), cardiopulmonary system and genitourinary system (1, 3, and 4).

The neurological involvement in this infectious disease has a variety manifestation and usually occurs without a background disease (5). These include encephalitis, meningoenephalitis, radiculitis, myelitis, peripheral and cranial neuropathies, subarachnoid haemorrhage and psychiatric appearance. Some psychiatric disorders consequent to *Brucella* infection have been reported such as depression, amnesia, psychosis, agitation, nightmares, personality disorder and euphoria as well as some rare symptoms including headache, confusion, and gait disorders (6-8). These complications may appear in the acute stage of brucellosis or, even later, during the chronic phase (5).

The depression has been showed as the most common finding of psychiatric disturbance among brucellosis patients (10). Although, depressive disorders and mental confusion are common in brucellosis, direct invasion of the CNS occurs in less than 5% of patients (9). However, studies indicated

that psychiatric disorders disappeared among neurobrucellosis patients after administration of only antibiotics with no antidepressant or antipsychotic therapy (6).

In Iran the incidence of brucellosis has increased in recent years because of its incomplete eradicating in animals. Hamadan province in the western part of the country has been shown with the highest incidence rate in Iran and it was 130 cases per 100,000 population (11). The aim of this study was to determine the prevalence of depressive disorder among brucellosis patient attending to the central university hospital in Hamadan, Iran.

Methods

A case-control study was conducted and all consecutive patients with chronic brucellosis presenting to Farshchian Hospitan in Hamadan between October 2009 and September 2010 were included as cases. A case of brucellosis was defined by the presence of clinical symptoms of fever, fatigue, night sweats and myalgia confirmed by positive serologic tests (wright $\geq 1:160$, Coomb's test $\geq 1:320$, 2-mercapto ethanol $\geq 1:80$). Patients presented at the acute stage of the disease (less than two months) were not eligible for enrolment.

Healthy controls were randomly selected from patient companions at the hospital. The individual controls were defined as persons who were free of brucellosis and/or without a diagnosis of fever of undetermined origin. Also, controls with a history of hospitalization within the preceding 1 month as

well as having a chronic disease influencing depression such as CNS disorders (including, but not limited to, stroke, Parkinson's disease, and head trauma), cardiovascular disease, cancer, diabetes, and autoimmune system diseases such as lupus were not included the study.

The study protocol was performed in accordance with the declaration of Helsinki and subsequent revisions and approved by ethics committee at Hamadan University of Medical Sciences. All participants were informed of the study purpose and gave their verbal consent. Also, an informed consent was obtained from participants before entering into the study.

Information on patients and controls was supplemented with data obtained by interview with study subjects using a standard questionnaire. A Persian-validated translation of the Zung Depression Scale (ZDS) was used to assess depressive symptoms. The ZDS is a 20-item questionnaire to assess depressive symptoms at the time of testing (12). Cases and controls were asked to answer the questions themselves or respond the interviewer if they were not able to read or write. In analysis and

reporting the patients, we did not consider severity of the depression and its diagnosis was confirmed by the consulting clinical psychologist if the ZDS indicated a depression condition.

Results are given as “means \pm standard deviation” for continuous variables and number (percent) for categorical variables. Bivariate associations were assessed using the chi-square test or Fisher's exact test. Statistical analyses were performed using SPSS v.18 (SPSS, Chicago, Illinois, USA) and a *P* value less than 0.05 was considered significant.

Results

A total of 100 cases and 71 controls were analyzed: 57 cases (57%) and 39 controls (54.9%) were male. The mean age was 38 ± 15.8 (ranged from 14 to 72) years for cases and 39.5 ± 16.3 (ranged from 14 to 76) years for controls. All cases and controls were Iranian; 77% of cases and 76.1% of controls lived in villages. There was no difference between cases and controls on the demographic data. (Table 1)

Table 1- Demographic data and depression in two groups

	Case n=100	Control n=71	P value
Gender			
Male	57 (57%)	39 (54.9%)	NS
Female	43 (43%)	32 (45.1%)	NS
Age group			
29 and less	33 (33%)	27 (38%)	NS
30-49	36 (36%)	29 (40.8%)	NS
50 and over	31 (31%)	15 (21.1%)	NS
Mean age	38 ± 15.8	39.5 ± 16.3	NS
Location			
Urban area	23 (23%)	17 (23.9%)	NS
Rural area	77 (77%)	54 (76.1%)	NS
Depression	53 (53%)	12 (16.9%)	<0.001

Table 2 shows the rate of depression in the two groups based on gender, age, and location. The prevalence of depression in case group was 53% vs. 16.9% in control group. There was a significant difference in the rate of depression between two groups ($\chi^2=22.9$, $P<0.001$). This difference remained significant in both genders, so among men 47.4% of cases vs. 17.9% of controls ($\chi^2=8.7$, $P=0.003$) and among women 60.5% of cases vs. 15.6% of controls ($\chi^2=15.2$, $P<0.001$) had a depressive disorder. Also,

this difference remained significant in all age groups ($P<0.05$).

Among participants who lived in urban area, there was no difference between two groups in the rate of depression (43.5% of cases vs. 35.3% of controls). However, the rate of depression was significantly higher among cases who lived in rural area (55.8% of cases vs. 11.1% of controls; $\chi^2=27.2$, $P<0.001$).

Table 2- Comparison of depression between cases and controls

	Depression in cases n=53	Depression in controls n=12	p value
Gender			
Male	27 (47.4%)	7 (17.9%)	0.003
Female	26 (60.5%)	5 (15.6%)	<0.001
Age group			
29 and less	19 (57.6%)	6 (22.2%)	0.006
30-50	20 (55.6%)	4 (13.8%)	<0.001
51 and over	14 (45.2%)	2 (13.3%)	0.034
Location			
Urban area	10 (43.5%)	6 (35.3%)	NS
Rural area	43 (55.8%)	6 (11.1%)	<0.001

Discussion

Brucellosis is a systemic infection that can involve any organ or organ system of the body. The disease has a variety of clinical features. It appears in the differential diagnosis of many infectious and noninfectious diseases. Although depression is a common complication of chronic brucellosis, there are little research data on this issue and data found in the literature are generally restricted to case reports or case series. This study conducted on 100 brucellosis patients and compared the prevalence of depression between these patients and a group of 71 healthy participants. Most of our patients were men with a mean age of about 38 years. Our findings suggest that the rate of depression may be as much as 53% higher in brucellosis patients than in normal population, in whom the prevalence of depression was indicated as about 17%. It highlights the high prevalence of depression in this infectious disease. Some other studies have reported a lower rate of depression in brucellosis. Shehata et al in a study on brucellosis patients showed that depression was seen in 7 of 27 (25.9%) patients (13). Gul et al conducted a pooled analysis based on primary data from 35 studies on brucellosis in Turkish medical practice (3). Totally, 187 neurobrucellosis was investigated and depression was found in 5% of cases. Eren et al compared 34 neurobrucellosis cases and 30 patients with brucellosis without neurological involvement (6). They found a mild depression among neurobrucellosis patients after the psychiatric examination and stated that the depression was in consequence of a general medical condition (neurobrucellosis). However, they found no depression among the brucellosis patients without neurologic involvement. The high rate of depression among our patients indicated that depressive disorder could not be related only to a neurological involvement as a special complication of neurobrucellosis. Although, depressive disorders could be directly due to destructive effect of *Brucella*

organism on CNS or indirectly as a result of cytokine or endotoxin on the neural tissue (5), the chronic nature of the disease as well as its long time treatment and its relative disability may aggravate this condition or even induce depression without any neurological involvement.

Another finding of our study was the higher rate of depression among patients resident in rural areas than their controls. However, there is no study on this field which compared the difference between rural and urban areas. Overall, the higher prevalence of depression among rural patients could be explained by occupational nature of the disease and its related disability as well as the high cost of diagnosis and treatment which are the major stressors for these patients. In fact, these stressors are a key source for onset of depression. It emphasizes the need for particular attention to mental health of the society, especially among those whose role in economic development cannot be negligible. Indeed, the negative impact of depressive disorders on economy is a consequence to the lack of manpower in the community, especially in rural areas. Also, coexistence of depression in the chronic condition of brucellosis can result in subsequent fail of treatment programs which may lead to more additional costs.

Conclusion

There is a need for attention to the cognitive and behavioral changes in brucellosis patients, especially in endemic areas. Study of these conditions may help to facilitate the treatment of *Brucella* infection. Also, psychiatric consulting as well as administering the cognitive function tests in these patients may lead to determine the etiology of disorder and prevent wrong medications. It is recommended further investigations with greater study samples to identify the specific role of microorganism in development of depressive disorder in brucellosis with comparing to the rate of depression in other chronic diseases.

Acknowledgments

The research was funded by Hamedan University of Medical Sciences. The funding source had no involvement in any aspect of the research. We acknowledge the help of the infection department of Farshchian University Hospital providing us with their census data, as well as the patients who participated in the study.

Corresponding author:

Peyman Eini MD. Farshchian Hospital, Mirzadeye eshghi Ave. Hamadan - Iran.

References

1. Pappas G, Akritidis N, Bosilkovski M, Tsianos E. Brucellosis. *N Engl J Med* 2005;352:2325-2336
2. Pappas G, Papadimitriou P, Akritidis N, Christou L, Tsianos EV. The new global map of human brucellosis. *Lancet Infect Dis* 2006;6:91-99
3. Gul HC, Erdem H, Bek S. Overview of neurobrucellosis: a pooled analysis of 187 cases. *Int J Infect Dis* 2009;13:e339-343
4. Buzgan T, Karahocagil MK, Irmak H, et al. Clinical manifestations and complications in 1028 cases of brucellosis: a retrospective evaluation and review of the literature. *Int J Infect Dis* 2010;14:e469-478
5. Ceran N, Turkoglu R, Erdem I, et al. Neurobrucellosis: clinical, diagnostic, therapeutic features and outcome. Unusual clinical presentations in an endemic region. *Braz J Infect Dis* 2011;15:52-59
6. Eren S, Bayam G, Ergonul O, et al. Cognitive and emotional changes in neurobrucellosis. *J Infect* 2006;53:184-189
7. Demiraslan H, Metan G, Mese EA, et al. Neurobrucellosis: an evaluation of a rare presentation of brucellosis from a tertiary care centre in Central Anatolia, Turkey. *Trop Doct* 2009;39:233-235
8. Yetkin MA, Bulut C, Erdinc FS, Oral B, Tulek N. Evaluation of the clinical presentations in neurobrucellosis. *Int J Infect Dis* 2006;10:446-452
9. Bodur H, Erbay A, Akinci E, et al. Neurobrucellosis in an endemic area of brucellosis. *Scand J Infect Dis* 2003;35:94-97
10. Gur A, Geyik MF, Dikici B, et al. Complications of brucellosis in different age groups: a study of 283 cases in southeastern Anatolia of Turkey. *Yonsei Med J* 2003;44:33-44
11. Hashemi SH, Keramat F, Ranjbar M, et al. Osteoarticular complications of brucellosis in Hamedan, an endemic area in the west of Iran. *Int J Infect Dis* 2007;11:496-500
12. Shafer AB. Meta-analysis of the factor structures of four depression questionnaires: Beck, CES-D, Hamilton, and Zung. *J Clin Psychol* 2006;62:123-146
13. Shehata GA, Abdel-Baky L, Rashed H, Elamin H. Neuropsychiatric evaluation of patients with brucellosis. *J Neurovirol* 2010;16:48-55

10/20/2012

Biochemical and pathological study of protective effect of Vitamin A in Azathioprine - induced pancreas toxicity in Rat

¹Rasoul Estakhri, ²Ali Khodadadi, ³Mahsa Parnian, ⁴Babak Hajipour, ²Mehdi Kamalipour, ⁵Maryam Mohsenikia, ⁶Ehsan Jangholi, ⁷Fereydoon Abedi

¹Departemnet of Pathology, Tabriz University of Medical Sciences, Tabriz, Iran

² Resident of Veterinary Clinical Pathology, Science and Research Branch of Islamic Azad University of Tehran, Iran

³ Student of Guidance and counseling, Payame noor University (PNU) of Benis-Iran

⁴ Department of Surgery, Urmia University of Medical Sciences, Urmia (Iran)

^{5,6} Young Researchers Club, Islamic Azad University-Tehran Medical Branch, Tehran, Iran

⁶ Student Research committee, Islamic Azad University-Tehran Medical Branch, Tehran Iran

⁷ Student of Biotechnology, Higher Education Institute of Rab-Rashid, Tabriz – Iran.

Correspond author: Babak Hajipour; Email: hajipourb@yahoo.com

Abstract: Azathioprine (AZA) is the most widely used immunosuppressive drug for preventing graft rejection and autoimmune disease. However, the therapeutic treatment induces several side effects such as toxicity to bone marrow, pancreas, liver and gastrointestinal tract. One of the major functions of Vitamin A is to act as a natural antioxidant by scavenging free radicals. Considering the kind of Azathioprine-induced damage in Pancrease tissue, we decided to study the protective effect of Vitamin A against Azathioprine-induced toxicity. Forty Male Wistar rats were divided into 4 groups (each group contains 10 rats). Group 1 was control group and only took normal saline. Groups 2 & 3 were administrated daily use of Vitamin A for 7 days I.M. and Group 4 was administrated with normal saline instead of Vitamin A in same condition as groups 2&3. In the last day groups 3 & 4 were administrated with single dose of AZA, 15 mg/kg (IP). After 24 hours, we took the animals blood and tissue samples and studied them for biochemical and pathological examinations. This study showed that Azathioprine-induced damage on pancreas in group 3 is less than that in group 4 while the function of organ in group 3 is nearly the same as control group. Also vitamin A decreases Azathioprine-induced toxicity on pancreas in rats. With Regard to importance of Azathioprine-induced damage, the usage rate of this drug in medicine, and the results of this study, we suggest that co-administration of Azathioprine and vitamin A decreases the toxicity of this drug.

[Rasoul Estakhri, Ali Khodadadi, Mahsa Parnian, Babak Hajipour, Mehdi Kamalipour, Maryam Mohsenikia, Jangholi, Fereydoon Abedi. **Biochemical and pathological study of protective effect of Vitamin A in Azathioprine - induced pancreas toxicity in Rat.** *Life Sci J* 2012;9(4):2538-2542] (ISSN:1097-8135). <http://www.lifesciencesite.com>. 376

Keywords: Azathioprine, Pancrease toxicity, Vitamin A.

1. Introduction

AZA is one of the immunosuppressive drugs that use in medicine and Veterinary in different remedies that derived from 6 mercaptopurine. Use of AZA in autoimmune disease is routine and co-administration of this drug with corticosteroids is choice for prevention of rejection of graft (3). Also this drug Uses in treatment of different disease like as Inflammatory Bowel Disease (IBD)(10,13), Acute Lymphoblas Leukemia, Rheumatoid Arthritis (8), Ulcerative Colitis (6,14), etc.

Mechanism of this drug is depended to prevention of synthesis of purines and followed prevention of RNA and DNA synthesis. Although, Azathioprine is mostly use but despite of its lymphocytic suppressive effect in patient, there is evidence that it cause bone marrow toxicity, digestive system toxicity and other organ toxicities. That is demonstrated that this druge induced

oxidative stress and damage on organs (9,11,15) that it is related to free radicals production like as superoxide anions (7,15).

Broe PJ and Cameron, J.L. demonstrated that no change induced by administration of AZA on amylase levels but reduction of bicarbonate and trypsin levels in comparison to control group was observed (1,2).

Foitzik T. in 1998 showed that cell necrosis is one of other damages that induced by AZA administration (4).

Watanabe et al. (1979) confirmed that Azathioprine oral consumption increases alkaline phosphatase (ALP), Gamma Glutamyl Transferase (GGT) in liver. In addition, from a pathological respect this drug cause necrosis in lobular center, proliferation of mitochondria and endoplasmic reticle (15).

Vitamin A is one of the fat soluble vitamins that have more functions that are related to skin, auditory and ... this vitamin is an antioxidant and prevents against oxidative stress that demonstrated by findings of other researches (5,12).

Spain scientists (2006) showed that vitamin A is one of the important antioxidants (5). Noyan S. and et al. (2006) demonstrated hepatoprotective effect of vitamin A against CCl₄ induced liver toxicity (12).

As the rat's pancreas toxicity is because of oxidative stress of Azathioprine, and producing free radicals, the objective of this study was to evaluate the effects of vitamin A against pancreas damage due to Azathioprine prescription.

2. Material and Methods

Investigation using experimental animals were conducted in accordance with the internationally accepted principles for laboratory animal use and care as found in the United States National Institute for Health publication No.85-23, revised in 1985) and the ethical Committee on animal care approved the protocol. Forty male Wistar rats that were apparently healthy were selected and divided into 4 equal groups. After body-weighting of each group by digital balance, all animals were kept in individual cages during the whole experimental period, under strict hygienic conditions and fed with standard ration for rat ad libitum.

In lighting for 12 h and darkness for the same hours in 25°C to get used to the environment. Then 1.5 ml of blood sample was taken via the tail vein from the members of all groups and the samples were studied in a way that will describe as following.

For the first group, as the control one, normal saline was given. The second and third groups received 100 mg/kg of vitamin A daily and for 7 days by IM injection. The fourth group, that had similar state with three others, normal saline was injected for 7 days. On the 7th day, both group 3 and 4 treated by 15 mg/kg Azathioprine (Ramopharmin Pharmaceutical lab-50 mg per tablet) as a single dose and IP form. Two other groups only received the solvent of Azathioprine in the same dose and manner. Twenty-four hours after Azathioprine injection, the animals after being weighted were anesthetized by ether and blood sample were taken via the tail vein and pathological sample was got from pancreas. The samples were allowed to clot and then their serum was separated by centrifuge machine of 2500 rpm for 10 min.

Biochemical parameters including amylase and lipase and glucose were measured by identification kit of biochemistry and bio-wave spectrophotometer apparatus. Tissue samples were fixed in formalin

10% and then pathology cope was produced of them. After Hematoxylin and Eosin staining, they were compared in terms of cellular damages such as degenerative changes, cellular death and inflammation changes.

Statistical analysis

All biochemical results were expressed as mean \pm SD. Significant differences among groups were determined by one-way analysis of variance (ANOVA) followed by student t-test using the statistical analysis software (SPSS) Ver.13, significance was considered at $p < 0.05$.

3. Results

Differences of weight values between groups:

Mean of weight parameters between groups are observed in table 1. Parameters showed that final mean of weight in control group compared to initial mean of weight increased. Group vitamin A and co-administration of vitamin A and AZA were same with control group and showed significant increase between first and last mean of weight values ($p < 0.05$).

AZA group showed significant decrease of final values of weight compared to first values ($p < 0.05$).

Table 1: Initial and final weight averages in several groups of animals

Groups	Initial weight averages	Final weight averages
Control	153 \pm 5 a	161 \pm 4 b
AZA	158 \pm 3 a	144 \pm 5 b
Vit A	150 \pm 9 a	159 \pm 1 b
AZA + Vit A	153 \pm 3 a	157 \pm 5 b

Dissimilar letter(s) in each row shows that there is a meaningful difference ($p < 0.05$).

Table 2 shows the average of chemical parameters such as insulin, glucose, amylase, lipase in both control and Azathioprine receiving group and the group got vitamin A and the group got vitamin A co-administrated with Azathioprine.

Glucose values between groups show no differences between Control and Vitamin A and co-administration of vitamin A and AZA but there are significant increases observed between AZA and control groups. Amylase and Lipase values were same with glucose and had no difference between Control and AZA+vitamin A and Vitamin A, but there are significant increases between AZA and control groups ($p < 0.05$).

Values of insulin measurement were compared between groups and showed significant decrease in AZA group to others ($p < 0.05$).

Table 2: Biochemical parameters

	Amylase(u/l)	Lypase(u/l)	Insulin(iu/l)	Glucose(mg/dl)
Control	703.75+/-3.59 a	1.8 +/- 0.2 a	0.19 +/- 0.05 a	74.97 +/- 9.76 a
AZA	1020.75+/- 0.96 b	2.5 +/- 0.01 b	0.11 +/- 0.06 b	160.67 +/- 15.71 b
Vit A	785+/- 3.22 a	1.81 +/- 0.5 a	0.18 +/- 0.1 a	78.95 +/- 2.65 a
AZA+Vit A	899.75+/-8.62 a	1.95+/-0.17 a	0.16+/- 0.05 a	102.17+/- 15.78 a

Data are expressed as Mean+/-SEM, N=10. Dissimilar letter in each row shows that there is a meaningful difference ($p < 0.05$).

Pathological Study

Histological studies of the pancreas were carried out on experimental groups. Histological parameters of the pancreas were normal in control rats. Histopathologic changes in the pancreas of Azatioprin treated rats include: Acute necrosis of the exocrine pancreas and loss of cell polarity and zymogen granules, chronic post necrotic interstitial pancreatitis, dilation of ductus and hydropic degeneration of ductal epithelium and periductal inflammation and fibrosis, severe atrophy of acinar parenchyma, necrosis of pancreatic fat, evidence of chronic post necrotic interstitial scarring, accumulation of fibrinous exudate and edema within the interlobular septa and inflammatory cell infiltrate, large areas of hemorrhage, severe destruction of the islet of Langerhans with reduced number of islet cells (Figures 1-2).

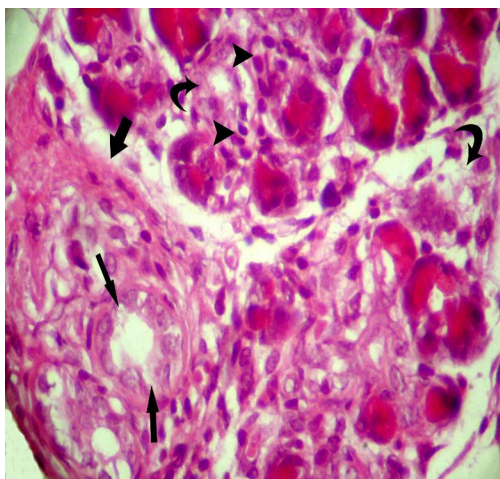

FIG 1- In Azatioprin treated animals, acute necrosis of the exocrine pancreas (curved arrows) and chronic post necrotic interstitial pancreatitis (arrowheads) is prominent. Dilation of ductus and hydropic degeneration of ductal epithelium (thin arrows) and periductal inflammation and fibrosis (thick arrow) are also seen.

After administration of Azatioprin and Vitamin A respectively, there were any significant recovery in pancreatic damages caused by Azatioprin. However, histopathology of the pancreas in these groups

showed moderate to severe tissue damages, almost similar to group AZA, which treated merely with Azatioprin (Figure 3).

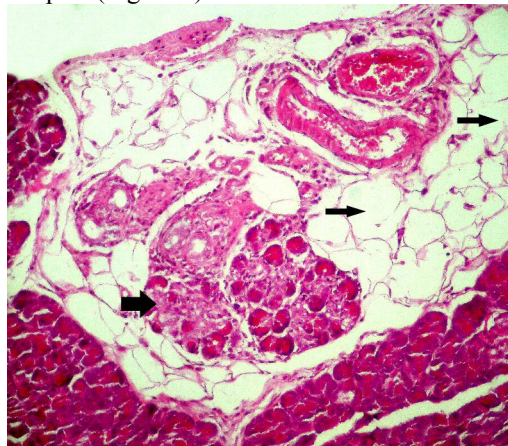

FIG 2- Note the severe atrophic lobule of acinar parenchyma, centered on necrotic pancreatic fat (thin arrows) with evidence of chronic post necrotic interstitial scarring (thick arrow) in Azatioprin treated animals.

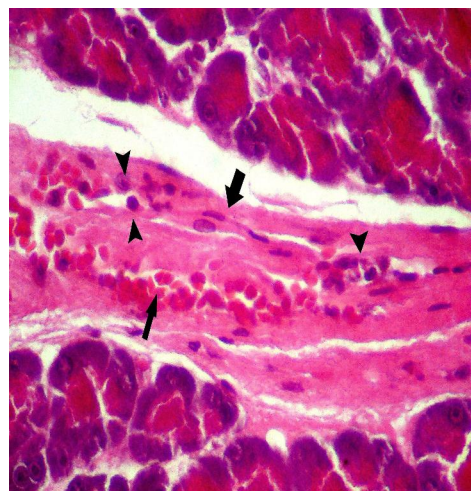

FIG 3- Microscopic appearance of Azatioprin & Vitamin A treated pancreas shows abundant fibrous connective tissue (thick arrow) which contains chronic inflammatory cells (arrowheads) and hemorrhage within the interlobular septa.

4. Discussion

Now a days, disease such as cancers and autoimmune problems are common throughout the world and increase continuously. In order to encounter against this troubles, it involves using drugs that not only prevent disease progression, but has also lessen side effects on natural function of cells and organs patient's body.

Among this drugs, azathioprine is one of the widely used of them in these days (9).

This drug is prescript in disease such as IBD, acute lymphoblastic leukemia, rheumatoid arthritis, ulcerative colitis, auto immune hepatitis, IgA nephropathy, dermatologic disease and etc.

It can prevent resynthesis of purine bases and so preventing cellular replication by inhibiting the RNA and DNA synthesis. The toxicity effect of this drug in different organs, such as bone marrow, liver, digestive system and pancreas, following its usage is distinct (9,11,15). The toxicity of this drug is because of producing free radicals in body. In current study we decided to investigate protective effects of vitamin A against toxicity of AZA in pancreas tissue.

Weight results show that following toxicity and damages of Azathioprine in AZA group, growth of animals had defects and final weights are lower than initiate weights. In co-administration of AZA and vitamin A, results aren't same with control group but shows that vitamin A could protected toxicity induced by Azathioprine in pancreas tissue. Vit A group had same results with control group.

Results showed that Insulin values in AZA group in compare with control group had significant decrease that this is another cause of toxicity of Azathioprine in AZA group. This could related to production of free radicals and induction of defects in function of antioxidant systems of tissue following to administration of Azathioprine drug. Results in AZA+Vit A group and Vit A group show no significant differences to control group and showed that vitamin A could protect against Azathioprine drug.

Serum values of Amylase and Lypase in AZA group showed significant decrease in compare to control group that it could be related to toxicity of drug in exocrine site of pancreas but values in Vit A group are similar to control group and in AZA + Vit A group results are close to control and had significant differences with AZA group and showed protective effects of Vit A against Azathioprine. This is important that our results don't demonstrated with Broe P.J. & Cameron, J.L. about serum values of Amylase(2).

Pathological results showed acute toxicity induced by Azathioprine in endocrine and exocrine

sites of pancreas tissue. Results in co administration of vitamin A and Azathioprine group showed low improvement in this group in compare to AZA group.

In current study the toxicity of Azathioprine in different tissues has been approved, so we should try to use this drug as less as possible except in emergency occasions. Then, as this drug can affect body's antioxidant system, it's better to use vitamins and antioxidant drugs together with it.

Our results showed that Vitamin A as a weak antioxidant have protective effects against toxicity induced by Azathioprine drug in pancreas tissue but that is suggested to investigate other antioxidant vitamins and agents to identifying the best protective agent against toxicity induced by Azathioprine.

References

- 1) Ateş, B., Batçioğlu, K., Eşrefoğlu, M., Gul, M., Selimoğlu Mukadder, A., (2006): Antioxidative effect of melatonin, ascorbic acid and N-acetylcysteine on caerulein-induced pancreatitis and associated liver injury in rats, *World J Gastroenterol*. 12(2):259-264.
- 2) Broe, P.J., Cameron, J.L., (1983): Azathioprine and acute pancreatitis: studies with an isolated perfused canine pancreas. *J Surg Res*. 34(2):63-159.
- 3) Di landro, D., Sarzo, G., Marchini, F., (2000): New immunosuppressive treatment in kidney transplantations. *Clinical Nephrology*. 53: 23-32.
- 4) Foitzik, T., Forgacs, B., Ryschich, E., (1998): Effect of different immunosuppressive agents on acute pancreatitis: a comparative study in an improved animal model. *Transplantation*. 27,65(8):6-1030.
- 5) [Gonzalez-Reyes S](#), [Martinez L](#), [Martinez-Calonge W](#), [Fernandez-Dumont V](#), [Tovar JA](#). Effects of antioxidant vitamins on molecular regulators involved in lung hypoplasia induced by nitrofen, *J Pediatr Surg*. 2006 Aug;41(8):1446-52.
- 6) Kader, H.A., Mascarenhas, M.R., Piccoli, D.A., et al. (1998): Experiences with 6-Mercaptopurine and azathioprine therapy in pediatric patients with severe ulcerative colitis. *J Pediatric Gastroenterol. Nutr*. 28: 8-54.
- 7) Kaplowitz, N., (1977): Interaction of azathioprine and glutathione in the liver of the rat. *J Pharmacology*. 200: 479-486.
- 8) Kerstens, P.J., Boerbooms, A., Jeurissen, M.E., et al. (2000): Radiological and clinical results of long-term treatment of rheumatoid arthritis with methotrexate and azathioprine. *J Rheumatol*. 27: 55-1148.
- 9) Lee, A.U., Farrell, G.C., (2001): Mechanism of azathioprine induced injury to hepatocytes: roles

- of glutathione depletion and mitochondrial injury. *J Hepatology*. 35: 756-764.
- 10) Ludwig, D., Stange, E.F., (1999): Efficacy of azathioprine in the treatment of chronic active Crohn's disease. *Gastroenterol*. 37:91-1085 .
- 11) M, R., M. A., Gado, A., (2003) : A comparison of hepatoprotective activities of aminoguanidine and N-acetylcysteine in rat against the toxic damage induced by azathioprine. *Comp Biochem Physiol C Toxicol Pharmacol*. 134 (4):6-451.
- 12) [Noyan S](#), [Cavusoglu I](#), [Minbay FZ](#). The effect of vitamin A on CCl4-induced hepatic injuries in rats: a histochemical, immunohistochemical and ultrastructural study. *2006;107(6):421-34*.
- 13) Pearson, D.C., May, G.R., Fick, G., et al.(2000):Azathioprine for maintaining remission of Crohn's disease. *Cochrane Database. syst. Rev. CD000067*.
- 14) Sood, A., Midha, V., Sood, N., et al. (2000): Role of azathioprine in severe ulcerative colitis: one year, placebo controlled, randomized trial. *Indian J Gastroenterol*. 19: 6-14.
- 15) [Watanabe, A.](#), [Hobara, N.](#), [Tobe, K.](#), [Endo, H.](#), [Nagashima, H.](#),(1979):Biochemical and morphological study on hepatotoxicity of azathioprine in rat, *Acta Med Okayama*. 33(1):5-14.

9/6/2012

Anew Shoe Decreases Pain and Fatigue in Ascending and Descending the stairs in patients with knee osteoarthritis

¹Amir Mohammad Navali, ²Bina Eftekhar Sadat, ³Babak Hajipour, ²Reza Ranjbaran

¹Department of Orthopedics, Tabriz University of Medical Sciences, Tabriz(Iran)

²Department of Rehabilitation Medicine, Tabriz University of Medical Sciences, Tabriz(Iran)

³Department of Surgery, Urmia University of Medical Sciences, Urmia (Iran)

Corresponding Author: Babak Hajipour MD, Postbox:51385-3633, Tabriz (Iran); [Tel:+98-9141075936](mailto:Hajipourb@yahoo.com); E-mail: Hajipourb@yahoo.com

Abstract: Osteoarthritis (OA) is a common painful and chronic condition that affects a large proportion of the older population. Patients with knee OA often present with decreased stair climbing performance, measured as time needed to ascend and descend a given number of stairs, and stair climbing performance is frequently used as a measure of function in this patient group. The aim of this study was to evaluate the effect of a new shoe on improving knee OA in ascending and descending the stairs in terms of pain and fatigue. Ninety-nine patients were divided into two group by gender and age adjustment. Group one consisted of forty nine patients, 44 (89.8%) female and 5 (10.2) male, mean age was 58.71 ± 6.98 in this group. Group two was consisted of 50 patients 43 (86%) female and 7 (14%) male, mean age was 58.38 ± 8.84 in this group. Visual analog scale (VAS) and fatigue score and duration of ascending and descending of stairs was studied in the patients with and without wearing the new shoe. VAS and fatigue score were lower in patients during wearing the designed shoe, although there was no significant difference in ascending and descending duration of stairs with or without shoe. Our experiment showed that a new designed shoe can improve OA patients in ascending or descending the stairs and improve their fatigue score, so it may be useful to improve their life quality through decreasing their pain in ascending and descending the stairs. [Mohammad Navali, Bina Eftekhar Sadat, Babak Hajipour, Reza Ranjbaran. **Anew Shoe Decreases Pain and Fatigue in Ascending and Descending the stairs in patients with knee osteoarthritis.** *Life Sci J* 2012;9(4):2543-2549] (ISSN:1097-8135). <http://www.lifesciencesite.com>. 377

Key words: Shoe - Pain - Fatigue - stairs – osteoarthritis.

1. Introduction

Osteoarthritis (OA) is a disease in which the joint cartilage breaks down, leading to joint changes (1) and chronic pain. Knee OA is a common painful and chronic condition that affects a large proportion of the older population [1]. Osteoarticular diseases reduce the rheological properties of synovial fluid in the various joints that increase the susceptibility of the articular cartilage to damage [2].

Estimated population prevalence varies from 4 - 30% depending on the age, sex and disease definition. Knee OA is a multifactorial disease [3]. The cause of OA remains unknown, though there is clear evidence for major risk factors, such as age, obesity, joint trauma, and heavy work load [3]. The risk factors can be divided into systemic (for example age, gender, genetics and over weight) and local biomechanical factors, such as joint injury and mal alignment, over weight and muscle weakness[4]. Abnormal mechanical loading in various sport activities or during heavy work may activate the biochemical cascade that leads to joint degeneration and pain, but also even in normal mechanical loading if the cartilage is impaired. Of all the risk factors known, obesity is most strongly associated with development and progression of knee OA [5].

Although the pathogenesis of knee OA is not well understood, biomechanical stresses that affect the articular cartilage and subchondral bone have been implicated as important inciting factors [6,7]. Radin et al [8] postulated that the repetitive impulsive loading may first induce trabecular micro fractures in the subchondral bone. According to this theory, subsequent remodeling increases the stiffness and thickness of the subchondral bone in an attempt to dampen impact forces. As a consequence, the over lying cartilage may become overloaded a break down resulting in cartilage degeneration and loss [8]. The incidence of knee OA is estimated to increase because the proportion of elderly population continues to raise [9]. Knee OA has a substantial impact on activities of daily living treatment strategies for knee OA, so foot orthoses, knee braces and footwear, have been proposed to minimize the knee adduction moment, and consequently reduce the loading on the knee OA [9-10]. One of the common complaints of an individual suffering from OA of the knee joint is pain while climbing stairs. Tibiofemoral joint weight loading is six times greater during stair descending comparing to level walking and thus frequently causes pain in patients with knee OA[11].

Patients with knee OA often present with decreased stair climbing performance, measured as time needed to ascend and descend a given number of stairs, and stair climbing performance is frequently used as a measure of function in this patient group [12,13]. The ability to ascend stairs is directly related to the function of the quadriceps femoris. It has been suggested that these patients lean their trunk forward to compensate for weakness in their quadriceps muscles [14]. Thus, as the severity of knee OA increases, it is likely that patients may also adopt compensatory strategies associated with a forward trunk lean [15].

In this study we used a kind of shoe to see if using this kind of shoe can help OA patients in ascending or descending the steps.

The aim of this study was to evaluate the effect of a new shoe on improving knee OA in ascending and descending the stairs in terms of pain and fatigue. In brief by considering mathematical calculations, it is clear that by decreasing stair height to half of its height, the torque force on knee joint decreases about 20% in ascending and descending the stairs, and this result in reduction of pain and accelerating of stair ascending and descending by patients. We did this by designing a shoe with half height of the stairs height. By this design during ascending the stairs, in each step, because of height of the shoe the patients have passed half height of the stairs before elevating his/her foot, and this result in torque force. This shoes are designed to use single step system of ascending and descending (in ascending, first foot without the shoe ascends and then foot wearing the shoe with put next to the other foot, in descending the action is reverse).

2. Material and Methods

Patients:

Ninety-nine patients were divided into two groups by gender and age adjustment. Group one consisted of forty nine patients, 44 (89.8%) female and 5 (10.2) male, mean age was 58.71 ± 6.98 in this group. Group two was consisted of 50 patients 43 (86%) female and 7 (14%) male, mean age was 58.38 ± 8.84 in this group.

Inclusion criteria:

(1): Fulfilling the diagnostic criteria of American college of rheumatology including: age over 50 years of old, joint stiffness below thirty minutes and finally criptation by osteophyte. (2):The radiologic confirmation of knee OA. (3): Having bilateral knee OA having pain and disability in ascending or descending the stairs.

Exclusion criteria:

(1):Age under 50 years of old. (2):Underlying systemic diseases like congestive heart failure, COPD and etc.(3): Any disease causing imbalance and

ataxia.4.Knee OA secondary to trauma, surgery, and etc.

Shoe:

The shoes were pair of shoes in which the right pair was 85 mm higher than the left pair (this height was the half height of each stair (170mm) that patients would ascend or descend on them). The shoes had strips to fasten the shoe and fit them to the foot (figure 1).



Figure 1. The shoes

Procedure:

After educating the patients about experiment procedure, visual analog scale (VAS) was explained to them and they were asked to score the scale before ascending the stairs (Pain intensity was assessed by a 100-mm visual analog scale (VAS)). Then they climbed a stairs consisted of nine steps by 170mm height in rehabilitation center of Imam Reza hospital, Tabriz, Iran. After climbing the steps they asked to score the VAS again. The score system includes 4 scores for both VAS and fatigue. 1: before ascending, 2:after ascending, 3:before descending, 4:after descending. There was a rest time of 20 minutes between the stages.

Ethics:

In this research patients considering inclusion and exclusion criteria were included in the research after informing them and explaining the experiment procedure. All participants provided written informed consent and were free to withdraw from the study at any time. The protocol was approved by local ethics committees.

Statistical Analysis

Differences in VAS and fatigue score between patients by shoe and control subjects were detected using analysis of variance (ANOVA; $P < 0.05$). Tukey test applied for posthoc comparison between groups. The difference in ascending and descending duration between groups was analyzed by Student T test and ($P < 0.05$) considered as significant level.

3. Results

3.1.VAS score:

The VAS score was significantly lower before ascending without shoe comparing to after ascending without shoe ($P < 0.0001$). The VAS score was significantly higher after ascending without shoe, comparing to before ascending without shoe ($P < 0.0001$), before ascending with shoe ($P < 0.0001$) and after ascending with shoe ($P = 0.022$) [Table 1, Figure2].

The VAS score was significantly lower before ascending with shoe comparing to after ascending without shoe ($P < 0.0001$), and after ascending with shoe ($P < 0.0001$). There was no significant difference in VAS score between before ascending without shoe and before ascending with shoe [Table 1, Figure 2].

The VAS score is presented in all the groups, and wearing shoe improved vas score comparing to not wearing the shoe significantly.

The VAS score was significantly higher between after ascending with shoe and before ascending without shoe ($P < 0.0001$) and before ascending with shoe ($P < 0.0001$) but it was lower than, after ascending without shoe ($P = 0.022$) [Table 1, Figure2]

Figure (3). Fatigue score in before and after ascending and descending with and without shoe.

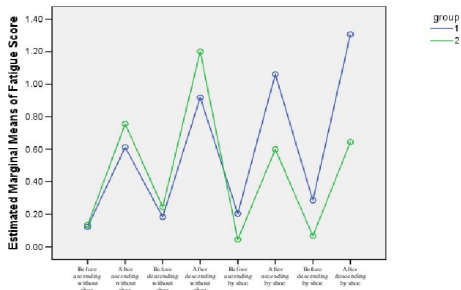
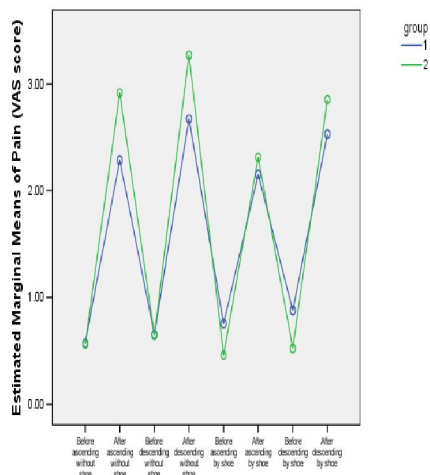

Table (1). VAS score in before and after ascending and descending with and without shoe.

VAS	(1 st : without shoe, 2 nd :by shoe)	(1 st :by shoe, 2 nd :without shoe)
Before ascending without shoe	0.57±0.73	0.56±0.74
Before ascending by shoe	0.75±0.96	0.45± 0.68
After ascending without shoe	2.28±1.30	2.91±1.45
After ascending by shoe	2.15±1.28	2.31±1.55
Before descending without shoe	0.65±0.90	0.64±0.93
Before descending by shoe	0.87±1.12	0.52±0.79
After descending without shoe	2.67±1.50	3.27±1.72
After descending by shoe	2.53±1.69	2.85±1.68

Figure (2). VAS score in before and after ascending and descending with and without shoe.



The VAS score was significantly lower between before descending without shoe comparing to after

descending without shoe ($P < 0.0001$) and after descending with shoe ($P < 0.0001$), but there was no significant difference in VAS score between before descending without shoe and before descending with shoe [Table 1, Figure2].

The VAS score was significantly higher between After descending without shoe and Before descending without shoe ($P < 0.0001$), Before descending with shoe ($P < 0.0001$) but there was no significant difference in VAS score between After descending without shoe and After descending with shoe ($P = 0.376$) [Table 1, Figure2].

The VAS score was significantly lower between before descending with shoe comparing to after descending without shoe ($P < 0.0001$) and after descending with shoe ($P < 0.0001$), but there was no significant difference in VAS score between before descending with shoe and before descending without shoe [Table 1, Figure2].

The VAS score was significantly higher between after descending with shoe and before descending without shoe ($P < 0.0001$), before

descending with shoe ($P<0.0001$), but there was no significant difference in VAS score between after descending with shoe and after descending without shoe ($P=0.376$) [Table 1, Figure2].

3.2. Fatigue score

The fatigue score was significantly lower between before ascending without shoe than after

ascending without shoe ($P<0.0001$) and after ascending with shoe ($P<0.0001$), but there was no significant difference in fatigue score between before ascending without shoe and before ascending with shoe [Table 2, Figure3].

Table (2). Fatigue score in before and after ascending and descending with and without shoe

fatigue	(1 st : without shoe, 2 nd :by shoe)	(1 st :by shoe, 2 nd :without shoe)
Before ascending without shoe	0.12±0.33	0.13±0.34
Before ascending by shoe	0.20±0.53	0.04±0.20
After ascending without shoe	0.61±0.99	0.75±1.19
After ascending by shoe	1.06±1.40	0.60±1.07
Before descending without shoe	0.18±0.44	0.24±0.48
Before descending by shoe	0.28±0.61	0.06±0.25
After descending without shoe	0.91±1.09	1.20±1.42
After descending by shoe	1.30±1.44	0.64±0.98

The fatigue score is presented in all the groups, and wearing shoe improved vas score comparing to not wearing the shoe significantly.

Figure (3). Fatigue score in before and after ascending and descending with and without shoe.

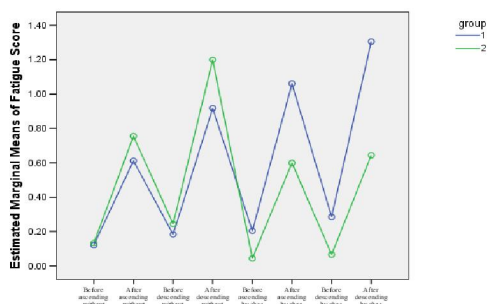

The fatigue score was significantly higher in after ascending without shoe than before ascending without shoe ($P<0.0001$), before ascending with shoe ($P<0.0001$) but there was no significant relation between after ascending without shoe and after ascending with shoe [Table 2, Figure3].

The fatigue score was significantly lower between before ascending with shoe and after ascending without shoe ($P<0.0001$), after ascending with shoe ($P<0.0001$). There was no significant difference in fatigue score between before ascending without shoe and before ascending with shoe [Table 2, Figure3].

The fatigue score was significantly higher between after ascending with shoe and before ascending without shoe ($P<0.0001$) and before ascending with shoe ($P<0.0001$) but it was significant

difference comparing to after ascending without shoe [Table 2, Figure3].

The fatigue score was significantly lower between before descending without shoe comparing to After descending without shoe ($P<0.0001$) and after descending with shoe ($P<0.0001$), but there was no significant difference in fatigue score between before descending without shoe and before descending with shoe [Table 2, Figure3].

The fatigue score was significantly higher between after descending without shoe and before descending without shoe ($P<0.0001$), before descending with shoe ($P<0.0001$) but there was no significant difference in fatigue score between after descending without shoe and after descending with shoe [Table 2, Figure3].

The fatigue score was significantly lower between before descending with shoe comparing to after descending without shoe ($P<0.0001$) and After descending with shoe ($P<0.0001$), but there was no significant difference in fatigue score between before descending with shoe and before descending without shoe [Table 2, Figure3].

The fatigue score was significantly higher between after descending with shoe and before descending without shoe ($P<0.0001$), before descending with shoe ($P<0.0001$) but there was no significant difference in fatigue score between after descending with shoe and after descending without shoe [Table 2, Figure3].

3.3. Ascending and descending duration:

The difference in time duration in (1st :without shoe, 2nd :by shoe) group for ascending by shoe and without shoe was not significant ($P=0.62$) [Table 3].

Table 3. Ascending and descending duration time.

	Ascending time (Seconds)	Descending time (Seconds)
Group (1 st :without shoe, 2 nd :by shoe)	39.73±13.04	40.89±13.16
Group (1 st :without shoe, 2 nd :by shoe)	22.24±27.75	22.44±12.52
Group (1 st :by shoe, 2 nd :without shoe)	38.72±13.02	37.24±13.66
Group (1 st :by shoe, 2 nd :without shoe)	21.16±9.80	23.56±12.63

There was no significant difference in time duration for ascending and descending the steps with or without shoe

The difference in time duration in (1st :without shoe, 2nd :by shoe) group for descending by shoe and without shoe was not significant (P=0.78) [Table 3].

The difference in time duration in (1st :shoe, 2nd :without shoe) group for ascending by shoe and without shoe was not significant (P=0.35) [Table 3].

The difference in time duration in (1st :shoe, 2nd :without shoe) group for descending by shoe and without shoe was not significant (P=0.41) [Table 3].

3.4. Data:

There was no significant difference in height, weight, hip flexion, hip extension, knee flexion and knee extension between two groups, Table 4.

Table 4. Demographic data of the patients

	Group (1 st :by shoe, 2 nd :without shoe)	Group (1 st :without shoe, 2 nd :by shoe)
Height	156.87±13.87	157.48±9.93
Weight	79.42±18.90	76.61±9.87
Hip flexion	118.57±9.24	121.00±8.45
Hip extension	25.06±26.75	20.06±3.28
Knee flexion	121.36±19.89	125.00±10.10
Knee extension	174.75±3.19	175.40±3.05

There was no difference in height, weight, hip flexion, hip extension, knee flexion and knee extension between two groups

4. Discussion:

Disability refers to persons impaired performance for socially defined life tasks that are expected in a typical sociocultural and physical environment of individual. Disability is a complex phenomenon influenced by pain, obesity, co morbidity, low level of physical activity, social and psychological factors as well as local impairments in lower extremities [18]. These will interfere with object performance tests and physical function. However, in knee OA, the limitations in physical function or activities of daily living play a crucial role in the development of disability. Pain is obviously a central factor in the physical function impairments via its direct effects on the function [18], but physiological [19] and social [20] factors contribute to the development of pain. They can be considered as mediators of pain and functional limitations.

The majority of patients with symptomatic knee OA do not attain satisfactory long-term relief, even with recent advances in pain relievers. Analgesic treatment may relieve the pain but does not improve biomechanics and may even aggravate OA. Although OA is complex and not completely understood, disease onset and progression are at least partly

related to responses by bone and cartilage to biomechanical loading. Devices that promote pressure reduction from the medial knee may provide pain relief while simultaneously protecting the joint from further degeneration; one such device is a lateral wedge orthotic shoe insert. When worn during weight-bearing activity, these inserts have been shown to reduce loading of the medial compartment and may provide pain relief. There is controversial evidence regarding whether foot orthoses or knee braces improve pain and function in selected patients with OA. We asked whether a new shoe would reduce pain, enhance functional scores. Patients with knee OA frequently demonstrate difficulties in stair climbing [21] evaluated by the time required to ascend or descend a given number of stairs. Stair ambulation performance is often used as measure of function in OA patients [22].

Our data showed that also there was no significant difference in ascending and descending duration with or without shoe, but VAS score and fatigue score was better in using our shoe comparing to not using the shoe. Unfortunately, there are rather few papers available about stair ambulation during the gait analysis among patients with knee OA. Recently, Asay et al [23] investigated patients with moderate or severe knee OA and compared the results with healthy controls during stair climbing task. Patients with more severe OA (KL>3)

demonstrated a greater peak trunk flexion angle, lower peak flexion moment and higher peak flexion moment than the controls. There was no difference in the knee flexion angle at the initial contact. Patients with one knee more severely affected than the other exhibited a decreased peak flexion moment on their more affected side compared to the contra lateral side. The authors concluded that the patients with severe knee OA tried to reduce uaderatus femoris demanded by leaning their trunk forward during stair climbing [23].

Kaufman et al [24] found no differences in the maximum knee flexion during stair ascent and descent between the control subjects and patients with knee OA. The patients demonstrated lower maximum knee internal extension moments both during stair ascent and descent. Female OA subjects exhibited a greater peak knee extension moment as well as more knee flexion Kaufman et al [24], again emphasizing the influence of gender. These results should be interpreted with caution, as the patients with knee OA were on average 27 years older walked at significantly slower speed and possessed different anthropometries compared to the controls. Hinman et al [25] reported that the patients with knee OA did not exhibit delayed temporal onset of VM muscle relatively to VL, in contrast to healthy controls, during stair climbing. Bennell et al [26] observed that the joint-position sense and QFM onset associated with the knee flexion angle at initial contact during stair descent, and further more, the Qfm strength correlated with the peak knee flexion angle occurring during the loading response. The authors concluded that the impaired sensorimotor function was not strongly associated with the altered joint kinematics in the knee OA patients during locomotion [26].

Kirkley et al. [27] described improvement on the Western Ontario and McMaster Universities (WOMAC) pain scale of 9% in 41 patients treated with an unloader valgus brace, which was better than a nonbraced control group. Brouwer et al. [28] noted a better knee function score (an improvement of 4 units of 100) after valgus bracing compared with nonbracing in a group of 95 patients with medial knee OA. A recent crossover RCT concluded wedged shoe insoles were not efficacious in patients with medial knee OA [29]. They compared laterally wedged insoles with neutral insoles, which may act as shock absorbers and relieve symptoms [30].

Hughes et al [31] reported that during both stair ascent and descent, the female subjects had a 6 to 8 degree greater peak knee flexion angle than males. The females also had a significantly greater peak knee flexion angle during level walking than men. The difference in peak knee flexion is most likely due to a significant difference in height between the

female and male subjects. The female subjects had a mean height of 162 cm (± 6) while the male subjects averaged 177 cm (± 8). Similarly, the female subjects generated a greater maximum internal knee extension moment than men for all conditions, with only stair ascent demonstrating a significant difference.

5. Conclusion:

Society must prepare itself for an aging world, OA is the most common cause of reported disabilities. Hence, disability and participation restriction is becoming an important component to assess in defining public health strategies. Current treatment is aimed at minimizing pain, maintaining or improving joint mobility, and decreasing functional impairment. Our experiment showed that a new designed shoe can improve OA patients in ascending or descending the stairs and improve their fatigue score, so it may be useful to improve their life quality through decreasing their pain in ascending and descending the stairs.

References:

1. Woolf AD, Pfleger B. Burden of major musculoskeletal conditions. *Bull World Health Organ.* 2003;81:646-656.
2. Foti C, Cisari C, Carda S, Giordan N, Rocco A, Frizziero A, Della Bella GA. A prospective observational study of the clinical efficacy and safety of intra-articular sodium hyaluronate in synovial joints with osteoarthritis. *Eur J Phys Rehabil Med.* 2011 Mar 15.
3. Arokoski J, Malmivaara A, Manninen M, Moilanen E, Ojala R, Paavolainen P, Ruuskanen J, Virolainen P, Virtapohja H, Vuolteenaho K, Osterman H. *Duodecim.* 2007;123(14):1759-60.
4. Arokoski JP, Lammi MJ, Hyttinen MM, Kiviranta I, Parkkinen JJ, Jurvelin JS, Tammi MI, Helminen HJ. Etiopathogenesis of osteoarthritis. *Duodecim.* 2001;117(16):1617-26; quiz 1626, 1679.
5. Nuki G, Salter D. The impact of mechanical stress on the pathophysiology of osteoarthritis. In: Sharma L, Berenbaum F, editors. *Osteoarthritis: a companion to rheumatology.* Philadelphia: Mosby; 2007. p. 33-52.
6. Jackson BD, Wluka AE, Teichtahl AJ, Morris ME, Cicuttini FM. Reviewing knee osteoarthritis-A biomechanical perspective. *J Sci Med Sport.* 2004;7(3):347-57.
7. Roemhildt ML, Coughlin KM, Peura GD, Badger GJ, Churchill D, Fleming BC, Beynon BD. Effects of increased chronic loading on articular cartilage material properties in the Lapine tibio-femoral joint. *J Biomech.* 2010;43:2301-2308.
8. Radin EL, Paul IL, Rose RM. Role of mechanical factors in pathogenesis of primary osteoarthritis. *Lancet.* 1972 Mar 4;1(7749):519-22.
9. Nakajima K, Kakihana W, Nakagawa T, Mitomi H, Hikita A, Suzuki R, Akai M, Iwaya T, Nakamura

- K, Fukui N. Addition of an arch support improves the biomechanical effect of a laterally wedged insole. *Gait Posture*. 2009;29:208–213.
- 10-Baker K, Goggins J, Xie H, Szumowski K, LaValley M, Hunter DJ, Felson DT. A randomized crossover trial of a wedged insole for treatment of knee osteoarthritis. *Arthritis Rheum*. 2007;56:1198–1203.
 11. Andriacchi TP, Andersson GBJ, Fermier RW, et al. A study of lower-limb mechanics during stair-climbing. *J Bone Joint Surg*. 1980;62:749-757.
 - 12-Mizner RL, Petterson SC, Snyder-Mackler L. Quadriceps strength and the time course of functional recovery after total knee arthroplasty. *J Orthop Sports Phys Ther* 2005, 35: 424–436.
 13. Shrader MW, Draganich LF, Pottenger LA, et al. Effects of knee pain relief in osteoarthritis on gait and stair-stepping. *Clin Orthop Relat Res* 2004; 421:188–193.
 - 14.Andriacchi TP, Galante JO, Draganich LF. Relationship between knee extensor mechanics and function following total knee replacement. In: Dorr L, editor. *Proc 1st Ann Meet Knee Soc*. Baltimore, MD: University Park Press 1985; 83–94.
 - 15-Asay JL, Mündermann A, Andriacchi TP. Adaptive patterns of movement during stair climbing in patients with knee osteoarthritis.*J Orthop Res*. 2009 Mar;27(3):325-9.
 - 18.Sharma L, Cahue S, Song J, Hayes K, Pai YC, Dunlop D.Physical functioning over three years in knee osteoarthritis: role of psychosocial, local mechanical, and neuromuscular factors. *Arthritis Rheum*. 2003 Dec;48(12):3359-70.
 - 19.van Baar ME, Dekker J, Lemmens JA, Oostendorp RA, Bijlsma JWPain and disability in patients with osteoarthritis of hip or knee: the relationship with articular, kinesiological, and psychological characteristics. *J Rheumatol*. 1998 Jan;25(1):125-33
 - 20.Ethgen O, Vanparijs P, Delhalle S, Rosant S, Bruyère O, Reginster JY. Social support and health-related quality of life in hip and knee osteoarthritis. *Qual Life Res*. 2004 Mar;13(2):321-30
 - 21.Stratford PW, Kennedy DM, Woodhouse LJ. Performance measures provide assessments of pain and function in people with advanced osteoarthritis of the hip or knee. *Phys Ther*. 2006 Nov;86(11):1489-96.
 - 22.Shrader MW, Draganich LF, Pottenger LA, Piotrowski GA.Effects of knee pain relief in osteoarthritis on gait and stair-stepping. *Clin Orthop Relat Res*. 2004 Apr;(421):188-93.
 - 23.Asay JL, Mündermann A, Andriacchi TP.Adaptive patterns of movement during stair climbing in patients with knee osteoarthritis. *J Orthop Res*. 2009 Mar;27(3):325-9.
 - 24.Kaufman KR, Hughes C, Morrey BF, Morrey M, An KN.Gait characteristics of patients with knee osteoarthritis. *J Biomech*. 2001 Jul;34(7):907-15.
 - 25.Hinman RS, Bennell KL, Metcalf BR, Crossley KM.Temporal activity of vastus medialis obliquus and vastus lateralis in symptomatic knee osteoarthritis. *Am J Phys Med Rehabil*. 2002 Sep;81(9):684-90.
 - 26.Bennell KL, Hinman RS, Metcalf BR.Association of sensorimotor function with knee joint kinematics during locomotion in knee osteoarthritis. *Am J Phys Med Rehabil*. 2004 Jun;83(6):455-63; quiz 464-6, 491.
 27. Kirkley A, Webster-Bogaert S, Litchfield R, Amendola A, MacDonald S, McCalden R, Fowler P. The effect of bracing on varus gonarthrosis. *J Bone Joint Surg Am*. 1999;81 :539–548.
 28. Brouwer RW, Raaij TM, Verhaar JA, Coene LN, Bierma-Zienstra SM. Brace treatment for osteoarthritis of the knee: a prospective randomized multi-centre trial. *Osteoarthritis Cartilage*. 2006;14:777–783.
 29. Baker K, Goggins J, Xie H, Szumowski K, LaValley M, Hunter DJ, Felson DT. A randomized crossover trial of a wedged insole for treatment of knee osteoarthritis. *Arthritis Rheum*. 2007;56:1198–1203.
 30. Kemp G, Crossley KM, Wrigley TV, Metcalf BR, Hinman RS. Reducing joint loading in medial knee osteoarthritis: shoes and canes. *Arthritis Rheum*. 2008;59:609–614.
 31. Hughes C. A., Kaufman K. R., Morrey B. F., Morrey M.A., K. N..Gender differences in knee kinematics and kinetics during stair climbing and level walking in adults with osteoarthritis of the knee.*Myoclinic/Foundation*,2000, <http://www.asbweb.org/conferences/2000/pdf/085.pdf>.

9/6/2012

Double-blind comparison of intra pleural analgesia through a catheter and intra pleural analgesia through a catheter beside a chest tube

Touraj Asvadi Kermani¹, Mehdi Zamiri², Saviz Pazhhan¹, Shahin Mir Mohammad Sadeghi², Babak Hajipour^{3,4}, Hamze majidi⁴

¹Assistant of General Surgery, Department of General Surgery, Imam Reza Hospital, Tabriz University of Medical Sciences, Tabriz, Iran.

²Department of surgery, Shahid Beheshti University of Medical Sciences, Tehran, Iran.

³Department of surgery, Urmia University of Medical Sciences, Urmia, Iran.

⁴Young Researchers club, Tabriz Branch, Islamic Azad University, Tabriz, Iran.

Correspond author: Babak Hajipour; Postbox:51385-3633, Tabriz city, Iran; E-mail, Hajipourb@yahoo.com; Tel:+98-9141075936

Abstract: Thoracotomy is a surgical procedure associated with severe pain. Operative morbidity rates reduce by effective postoperative pain control and the intensity of pain is exacerbated by ventilation. Thus, the goal of the clinician is to develop an analgesic regimen that provides effective pain relief to allow post operative thoracotomy patients the ability to maintain their functional residual capacity by deep breathing. One of these methods is insertion of an intrapleural catheters. In this study we tried to compare the efficacy of current method with the newer one, which is the implementation of a double lumen chest tube. The aim of this study is to compare the effectiveness of the chest tube catheter and intrapleural catheter for pain after thoracotomy. The study was double-blind and consisted of twenty patients undergoing thoracotomy and pulmonary mass resection (indicated because of malignancy or hydrated cyst) in Shahid Modarres hospital (Tehran, Iran) during September 2006 to March 2007. In our study, anesthetics did not make a difference in the 6th hour but improve pain indices in the 12th, 18th and 24th hour (only PHS). It can be postulated that during the first hours after the surgery the pain is too severe for the anesthetic to show significant improvement. Also, no significant difference was found between the routes of administration. This study shows that pleural anesthesia through a catheter secured in a tube is more favorable to intra pleural anesthesia through a catheter, concerning risk and surgery complications.

[Touraj Asvadi Kermani, Mehdi Zamiri, Saviz Pazhhan, Shahin Mir Mohammad Sadeghi, Babak Hajipour, Hamze majidi. **Double-blind comparison of intra pleural analgesia through a catheter and intra pleural analgesia through a catheter beside a chest tube.** *Life Sci J* 2012;9(4):2550-2555] (ISSN:1097-8135).
<http://www.lifesciencesite.com>. 378

Keywords: thoracotomy, local anesthesia, pain control, double lumen chest tube

1. Introduction

Thoracotomy is a surgical procedure associated with severe pain. Operative morbidity rates reduce by effective postoperative pain control and the intensity of pain is exacerbated by ventilation. Limited ventilation may cause atelectasis, hypoxia and pulmonary infection. Thus, the goal of the clinician is to develop an analgesic regimen that provides effective pain relief to allow post operative thoracotomy patients the ability to maintain their functional residual capacity by deep breathing. Various strategies including epidural analgesia, intrapleural analgesia, intercostals nerve blockade, systemic opioids, and non steroidal anti-inflammatory drugs (NSAIDs) have been used for thoracotomy pain management [1]. Considerable pain relief may be achieved with systemic opioids; however, these drugs may cause respiratory depression and intestinal dysfunction [2]. NSAIDs may be associated with gastrointestinal bleeding and renal toxicity, although they are useful [3].

Intrapleural analgesia was first described by Reiestad and Stromskag [4], and previous studies evaluating intrapleural analgesia in patients undergoing a thoracotomy revealed conflicting results [3].

Various analgesic techniques have been developed to treat postoperative thoracotomy pain [4-5]. However, the acute pain condition associated with thoracotomy continues to be a challenge to clinicians [6]. Systemic administration of opioids is the simplest and most common method to provide analgesia for postoperative pain; unfortunately, systemic opioid administration may not be adequate for treating the intense postoperative pain associated with thoracotomy.

In a meta-analysis of 65 studies, Ballantyne et al [7] concluded that postoperative epidural pain control may significantly decrease pulmonary morbidity. However, it is not appropriate for certain patients, especially those with coagulation disorders, spinal deformities, or neurologic disorders, or who have received anticoagulant therapy [5].

Intrapleural analgesia—the administration of local anesthetic agents through a catheter positioned inside the pleural cavity to diffuse across the parietal pleura and anesthetize the intercostals nerves—may be another alternative [8]. Several studies have shown limited improvement in analgesia with IP (Intrapleural analgesia) [9, 10, and 11]. Explanations for the limited analgesic efficacy of IP include loss of local anesthetic through the chest tube, dilution of local anesthetic with blood and exudative fluid present in the pleural cavity, binding of local anesthetic with proteins, and altered diffusion across the parietal pleural after surgical manipulation and inflammation [11, 12].

Another option to minimize post thoracotomy pain is extra pleural regional anesthesia. Extra pleural regional anesthesia depends primarily on diffusion of the analgesic agent into the par vertebral region [13]. Local anesthetic agents affect not only ventral nerve roots but also afferent fibers of the posterior primary ramos. Posterior ligaments of the posterior primary ramos innervate posterior spinal muscles and skin. These ligaments are usually traumatized during poster o lateral thoracotomy [14]. The procedure involves intermittent administration of local anesthetic to this area through a catheter placed in the extra pleural region. Depth and width of the anesthetized area depend on diffusion of the local anesthetic. This finding is one of the method's objective criteria for providing pain relief after thoracotomy.

2. Material and Methods

Patients:

The study had a double-blind interventional design. Twenty patients underwent thoracotomy and pulmonary mass resection (indicated because of malignancy or hydrated cyst) in Shahid Modarres hospital (Tehran, Iran) during September 2006 to march 2007. All patients considering their primarily problem, indicated for thoracotomy and their written approval had gotten these patients who referred to Shahid Modarres hospital during September 2006 to march 2007 which twenty patients followed the treatment regularly.

Exclusion criteria

The patients with: Under 12 years old, Under 30 kilograms, Low level of consciousness, Addicted , Depressed and the persons with psychological problems, empyema, Bleeding diathesis, Broncho pleural fistula, Sever adhesions of pleura, Underling problem of pleura such as chemical or surgical pleurodesis were eliminated from study.

Treatment protocol:

All patients got intra pleural analgesia through a catheter and intra pleural analgesia through a catheter beside a chest tube and also got two

different solution that there name were solution A and B. Anesthetic substance was 0.25% bupivacaine in amount of 0.5 mg /kg of patient weight.

In every time of injection intra pleural catheter (solution A) and intra pleural catheter beside a chest tube (solution B) got solution by chance. Only Anesthesiologists did know the Information about the type of solution so the patients and researcher did not know about it (double-blind).

After the surgery in every 6 hours, we decreased the pain until 24 hours. Before injection the pain score was measured by VAS and PHS (prince Henry score of pain), also maximum expiratory flow was measured by peak flow meter.

Te VAS that we used in our study as Linear scale that lied vertically and the patients were informed to show their pain score. Previous studies showed that this method is the appropriate method in compare with others.

By referring to previous studies we have known that PHS is appropriate and specific method in patients who underwent thoracic operation.

prince Henry score of pain	score
No pain on coughing	0
Pain on coughing, not deep breathing	1
Pain on deep breathing but not at rest	2
Pain at rest, slight	3
Pain at rest, severe	4

According to the previous studies one of the best factors in patients recovery is the rate of expiratory flow in patients so we measured this important factor with peak flow meter.

Statistical analysis

Data were expressed as means \pm SD. Differences among various groups were tested for statistical significance using the Mannwithney U test. A P value of less than 0.05 denoted the presence of a statistically significant difference.

3. Results

In this study twenty patients underwent thoracotomy. They were ten men and ten women. Mean age was 50.6 ± 13.92 .

These patients were divided to 2 groups into ten patients. And every 6 hours were injected analgesics by catheter or chest tube randomly. Pain score was estimated and compared with PFM, PHS, VAS factors before injection and half an hour after injection.

In first 6 hours estimated mean of VAS in patients who were got the drug from catheter, before injection of the analgesic was 74 ± 17.127 and after injection was 73 ± 18.287 . In the other hand in patients who were got the drug from chest tube, mean before the injection was 56 ± 18.378 and after that mean was 58 ± 18.738 .

In second 6 hours estimated mean of VAS in patients who were got the drug from catheter, before the injection of analgesic was 47.5 and SD was 23.243 but after the injection was 41 and SD was 23.781. In the other hand in patients who were got the drug from chest tube mean before the injection of drug was 72 and SD was 15.491 but after that mean was 64 and SD was 16.455.

In third 6 hours estimated mean of VAS in patients who were got the drug from catheter, before the injection of analgesic was 48 and SD was 30.840 but after the injection was 38 and SD was 30.110. In

the other hand in patients who were got the drug from chest tube mean before the injection of drug was 32 and SD was 28.596 but after that mean was 29 and SD was 26.012.

In 4th 6 hours estimated mean of VAS in patients who were got the drug from catheter, before the injection of analgesic was 30.5 and SD was 26.294 but after the injection was 32.5 and SD was 28.987. In the other hand in patients who were got the drug from chest tube mean before the injection of drug was 43 and SD was 32.335 but after that mean was 40 and SD was 29.439.

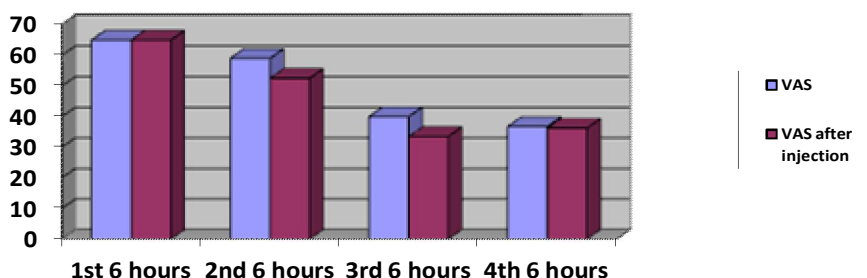

Figure 1. The diagram of the changes in patients pain before and after the analgesic injection according to the VAS scale.

In first 6 hours estimated mean of PHS in patients who were got the drug from catheter, before the injection of analgesic was 3.5 ± 0.707 and after that was 3.4 ± 0.843 . In the other hand in patients who were got the drug from chest tube mean before injection was 2.8 ± 1.135 but after that mean was 2.6 ± 1.075 .

In second 6 hours estimated mean of PHS in patients who were got the drug from catheter, before the injection of analgesic was 2.5 ± 1.269 but after the injection was 2.1 ± 1.197 . In the other hand in patients who were got the drug from chest tube mean before the injection of drug was 3.6 ± 0.699 but after that mean was 3.3 ± 0.823 .

In third 6 hours estimated mean of PHS in patients who were got the drug from catheter, before the injection of analgesic was 2.5 ± 1.581 but after the injection was 2 ± 1.333 . In the other hand in patients who were got the drug from chest tube mean before the injection of drug was 2.1 ± 1.370 but after that mean was 1.9 ± 1.370 .

In 4th 6 hours estimated mean of PHS in patients who were got the drug from catheter, before the injection of sedative was 1.9 ± 1.633 but after the injection was 1.9 ± 1.663 . In the other hand in patients who were got the drug from chest tube mean before the injection of drug was 2 ± 1.553 but after that mean was 2 ± 1.563 .

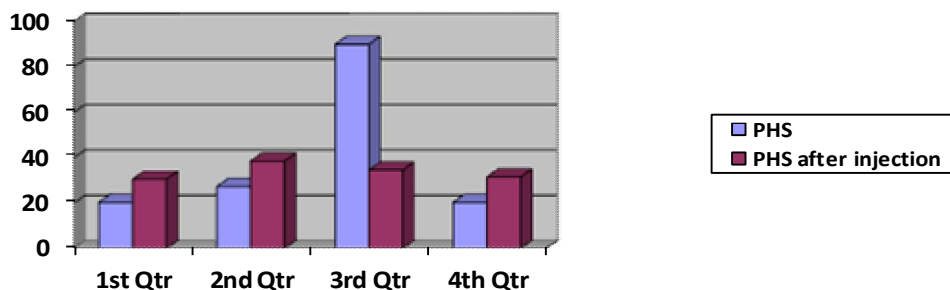

Figure 2. The diagram of the changes in patients pain before and after the analgesic injection according to the PHS scale

In first 6 hours estimated mean of PFM in patients who were got the drug from catheter before the injection of analgesic was 98 ± 33.928 but after the injection was 103 ± 34.335 . In the other hand in patients who were got the drug from chest tube mean before the injection of drug was 149 ± 85.173 but after that mean was 154 ± 84.089 .

In second 6 hours estimated mean of PFM in patients who were got the drug from catheter, before the injection of analgesic was 156 ± 87.076 but after the injection was 178 ± 100.862 . In the other hand in patients who were got the drug from chest tube mean before the injection of drug was 105 ± 33.082 but after that mean was 125 ± 37.785 .

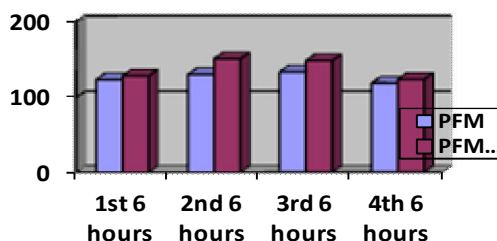

Figure 3. The diagram of the mean changes in patients PFM before and after the analgesic injection. Generally in the first time of checking patients means 6 hours after the surgery the average of pain before the injection of analgesic according to the VAS criterion was 65 which was still 65 half-hour after the injection.

According to the second criterion the average of pain in patients was 3.15 which was reduced to 3 half-hour after the injection of the analgesic.

The third criterion of the pain measurement for the patients is PFM in which the overall average before the injection of analgesic was 123.5 and half-hour after that was 128.5.

In second evaluation means 12 hours after the surgery, average of patients' pain according to the VAS criterion was 59, PHS was 3.05 and PFM was 13.05. These numbers reduced to 52.5, 2.7 and 151.5 half-hour after the analgesic injection respectively.

But in third stage mean of VAS, PHS and PFM before the injection was 40, 2.3, 134 and after that was 33.5, 1.95 and 149 respectively.

After 24 hours mean of VAS, PHS and PFM before the injection was 36.75, 1.9 and 119 and after that was 36.25, 1.95 and 124 respectively.

As we observed the effect of the analgesics in first 6 hours did not reduce patients pain indexes significantly but 12, 18 and 24 hours after that reduced the pain significantly (Tables 1 and 2).

In third 6 hours estimated mean of PFM in patients who were got the drug from catheter, before the injection of analgesic was 106 ± 62.751 and after the injection was 118 ± 78.993 . In the other hand in patients who were got the drug from chest tube mean before the injection of drug was 162 ± 96.355 and after that mean was 180 ± 106.874 .

In 4th 6 hours estimated mean of PFM in patients who were got the drug from catheter, before the injection of sedative was 155 ± 120.023 but after the injection was 161 ± 120.779 . In the other hand in patients who were got the drug from chest tube mean before the injection of drug was 83 ± 63.779 but after that mean was 88 ± 68.280 (Figures 1,2 and 3).

In addition that there was no significant relationship between the way of analgesic prescription (catheter or chest tube) and reducing the patients pain.

Table 1. The table of the efficacy of analgesics to reduce pain.

	test	Difference before and after anesthetic instillation(P Val)
6 th hour	VAS	0.7
	PHS	0.83
	PFM	0.058
12 th hour	VAS	0.009
	PHS	0.008
	PFM	0.003
18 th hour	VAS	0.016
	PHS	0.008
	PFM	0.007
24 th hour	VAS	0.783
	PHS	0.05
	PFM	0.62

Table2. The table of Methods of pain relief medication for patients.

	test	Difference before and after anesthetic instillation(P Val)
6 th hour	VAS	0.529
	PHS	0.739
	PFM	0.393
12 th hour	VAS	0.853
	PHS	0.739
	PFM	0.796
18 th hour	VAS	0.218
	PHS	0.28
	PFM	0.353
24 th hour	VAS	0.315
	PHS	0.971
	PFM	0.97

Discussion:

Post thoracotomy pain is known as severe and intense as a result of tissue damage to the ribs, muscles, and peripheral nerves. It is a complex phenomenon involving multiple neurotransmitters and excitatory and inhibitory pathways that are difficult to target and quantify. Pain is exacerbated by motion and coughing. These actions result in weak, superficial breathing and nonproductive coughing. The earliest change in respiratory mechanics during the postoperative period is the decrease in FEV1 and forced vital capacity. Decreased functional residual capacity and alveolar collapse during anesthesia may be impaired further by restrictive ventilation caused by postoperative pain and abnormal respiration pattern. Therefore, pain management plays a vital role in decreasing morbidity and alteration of lung function after thoracotomy [15, 16]

Various analgesic techniques have been developed to treat postoperative thoracotomy pain [4-5]. However, the acute pain condition associated with thoracotomy continues to be a challenge to clinicians [6]. Systemic administration of opioids is the simplest and most common method to provide analgesia for postoperative pain; unfortunately, systemic opioids administration may not be adequate for treating the intense postoperative pain associated with thoracotomy.

In a meta-analysis of 65 studies, Ballantyne et al [7] concluded that postoperative epidural pain control may significantly decrease pulmonary morbidity. However, it is not appropriate for certain patients, especially those with coagulation disorders, spinal deformities, or neurologic disorders, or who have received anticoagulant therapy [5].

Intrapleural analgesia—the administration of local anesthetic agents through a catheter positioned inside the pleural cavity to diffuse across the parietal pleura and anesthetize the intercostals nerves—may be another alternative [8]. Several studies have shown limited improvement in analgesia with Intrapleural analgesia [9, 10, and 11]. Explanations for the limited analgesic efficacy of Intrapleural analgesia include loss of local anesthetic through the chest tube, dilution of local anesthetic with blood and exudative fluid present in the pleural cavity, binding of local anesthetic with proteins, and altered diffusion across the parietal pleural after surgical manipulation and inflammation [11,12].

Another option to minimize post thoracotomy pain is extra pleural regional anesthesia. Extra pleural regional anesthesia depends primarily on diffusion of the analgesic agent into the par vertebral region [13]. Local anesthetic agents affect not only ventral nerve roots but also afferent fibers of the posterior primary ramos. Posterior ligaments of the posterior primary

ramous innervate posterior spinal muscles and skin. These ligaments are usually traumatized during poster o lateral thoracotomy [14]. The procedure involves intermittent administration of local anesthetic to this area through a catheter placed in the extra pleural region. Depth and width of the anesthetized area depend on diffusion of the local anesthetic. This finding is one of the method's objective criteria for providing pain relief after thoracotomy.

In our study, we aimed to compare two analgesic modalities for post thoracotomy pain (intra pleural analgesia through a catheter vs. intra pleural analgesia through a catheter beside a chest tube)

In this study there is no meaningful decrease in pain index in first 6 hour this phenomenon because of severe pain in first 6 hours after the operation, but these indexes were decreased meaningfully after 12, 18 and 24 hours in administration of analgesic substance.

In this study we understand that there are no meaningful differences between the ways of analgesic administration and rate of pain decreases.

As we mentioned the limitations of intra pleural analgesia through a catheter and intra pleural analgesia through a catheter beside a chest tube it seems intra pleural analgesia through a catheter beside a chest tube is easier and cheaper way to decrease the pain after thoracotomy, also it has low rate complication after surgery.

Authors' Contribution

Saviz Pazhhan and Shahin Mir Mohammad Sadeghi designed and supervised the study, Mehdi Zamiri and Babak Hajipour collected the data and wrote the paper. Mehdi Zamiri and Babak Hajipour and Hamze Majidi contributed to the data entry. Hamze Majidi contributed to the analyzed and interpreted the data. All authors read and approved the final revision.

References:

- [1] Chaney MA, Labovsky JK. Thoracic epidural anesthesia and cardiac surgery: balancing postoperative risks associated with hematoma formation and thromboembolic phenomenon. *J Cardiothorac Vasc Anesth* 2005;19:768—71.
- [2] Takamori S, Yoshida S, Hayashi A, Matsuo T, Mitsuoka M, Shirouzu K. Intraoperative intercostal nerve blockade for postthoracotomy pain. *Ann Thorac Surg* 2002;74:338—41.
- [3] Soto RG, Fu ES. Acute pain management for patients under going thoracotomy. *Ann Thorac Surg* 2003;75:1349—57.

- [4] Reiestad F, Stromskog KE. Intrapleural catheter in the management of postoperative pain: a preliminary report. *Reg Anaesth* 1986;11:89—91.
- [5] Savage C, McQuitty C, Wang D, Zwischenberger JB. Postthoracotomy pain management. *Chest Surg Clin North Am* 2002;12:251-63.
- [6] Soto RG, Fu ES. Acute pain management for patients undergoing thoracotomy. *Ann Thorac Surg* 2003;75:1349-57.
- [7] Ballantyne JC, Carr DB, deFerranti S, et al. The comparative effects of postoperative analgesic therapies on pulmonary outcome: cumulative meta-analyses of randomized, clinical trials. *Anesth Analg* 1998;86: 598-612.
- [8] McKenzie AG, Mathe S. Intercostal local anaesthesia: anatomical basis for mechanism of action. *Br J Anaesth* 1996;76:297-9.
- [9] Kambam JR, Hammon J, Parris WC, Lupinetti FM. Intrapleural analgesia for postthoracotomy pain and blood levels of bupivacaine following intrapleural injection. *Can J Anaesth* 1989;36:106-9.
- [10] Scheinin B, Lindgren L, Rosenberg PH. Treatment of postthoracotomy pain with intermittent instillations of intrapleural bupivacaine. *Acta Anaesthesiol Scand* 1989;33:156-9.
- [11] Silomon M, Claus T, Huwer H, Biedler A, Larsen R, Molter G. Intercostal analgesia does not influence postthoracotomy pain. *Anesth Analg* 2000;91:44-50.
- [12] Kreitzer JM, Reuben SS. Central nervous system toxicity in a patient receiving continuous intrapleural bupivacaine. *J Clin Anesth* 1996;8: 666-8.
- [13] Eng J, Sabanathan S. Site of action of continuous extrapleural intercostal nerve block. *Ann Thorac Surg* 1991;51:387-9.
- [14] D'Amours RH, Riegler FX, Little AG. Pathogenesis and management of persistent postthoracotomy pain. *Chest Surg Clin North Am* 1998;8: 703-22.
- [15] Warner DO. Preventing postoperative pulmonary complications. *Anesthesiology* 2000;92:1467-72.
- [16] Craig DB. Postoperative recovery of pulmonary function. *Anesth Analg* 1981;60:46-52.
- [17] Mourisse J, Hasenbos MA, Gielen MJ, Moll JE, Cromhecke GJ. Epidural bupivacaine, sufentanil or the combination for postthoracotomy pain. *Acta Anaesthesiol Scand* 1992;36:70-4.
- [18] Macias A, Monedero P, Adame M, Torre W, Fidalgo I, Hidalgo F. A randomized blinded comparison of thoracic epidural ropivacaine, ropivacaine/fentanyl or bupivacaine/fentanyl for postthoracotomy analgesia. *Anesth Analg* 2002;95:1344-50.
- [19] Takamori S, Yoshida S, Hayashi A, Matsuo T, Mitsuoka M, Shirouzu K. Intraoperative intercostal nerve blockade for postthoracotomy pain. *Ann Thorac Surg* 2002;74:338-41.
- [20] James EC, Kolberg HL, Iwen GW, Gellatly TA. Epidural analgesia for post-thoracotomy patients. *J Thorac Cardiovasc Surg* 1981;82: 898-903.
- [21] Logas WG, el-Baz N, el-Ganzouri A, et al. Continuous thoracic epidural analgesia for postoperative pain relief following thoracotomy: a randomized prospective study. *Anesthesiology* 1987;67:787-91.
- [22] Liu SS, Moore JM, Luo AM, Trautman WJ, Carpenter RL. Comparison of three solutions of ropivacaine/fentanyl for postoperative patient-controlled epidural analgesia. *Anesthesiology* 1999; 90:727-33.
- [23] Mann LJ, Young GR, Williams JK, Dent OF, McCaughan BC. Intrapleural bupivacaine in the control of postthoracotomy pain. *Ann Thorac Surg* 1992;53:449-54.
- [24] Kaiser AM, Zollinger A, Lorenzi D, Largiader F, Weder W. Prospective, randomized comparison of extrapleural versus epidural analgesia for post-thoracotomy pain. *Ann Thorac Surg* 1998;66: 367-72.

9/6/2012

Comparison Of Direct Visual Inspection (DVI) With Pap Smear In Diagnosis Of Precancerous Lesion Of Cervix

Fatemeh Mallah¹, Fatemeh Nazari¹, Nazli Navali¹, Babak Hajipour².

1. Women's Reproductive Health Research Center, Tabriz University of Medical Sciences, Tabriz, Iran

2. Department of Surgery, Urmia University of Medical Sciences, Urmia, Iran.

Corresponding author: Babak Hajipour, Post box: 51385-3633, Tabriz, Iran. Tel: +98-9141075936.

Abstract: The aim of this study was to compare direct visual inspection (DVI) with Pap smear in diagnosis of precancerous lesion of cervix. A total of 1500 women were screened cytologically as well as clinically with direct visual inspection of cervix after application of acetic acid (DVI). A total of 1500 women were screened cytologically as well as clinically with direct visual inspection of cervix after application of acetic acid (DVI). Women with abnormal findings in either Pap smear or DVI were investigated with colposcopy and biopsies were obtained from colposcopically assessed abnormal lesions. Seven women had abnormal Pap smear (6 ASCUS, 1 CIN₁) with colposcopy and biopsies. 3 of 7 were actually positive. All of 3 positive tests were positive in DVI but one of the 4 false-positive tests was positive in DVI. Nine women had abnormal DVI which colposcopy and biopsies confirmed 8 of them as premalignant or malignant lesions of cervix. Two of them were invasive cancer (negative Pap smears), 3 CIN₁ (one of them negative in Pap smear, one CIN₁, one ASCUS), 2 CIN₂ (one of them negative in Pap smear, one ASCUS) and 1 CIN₃ (negative Pap smear). Test efficiency parameters particularly sensitivity, specificity, and positive predictive values of DVI were 88.8%, 99.9% and 88.8%, respectively; those of Pap smear were 37.5%, 99.06%, 42.85%, respectively. Direct visual inspection (DVI) is feasible and easy to perform with superior sensitivity and specificity to Pap smear in detecting cervical premalignant and malignant lesions. Direct visual inspection can be used as an efficient primary screening tool with a satisfactory low biopsy rate in low resources settings.

[Fatemeh Mallah, Fatemeh Nazari, Nazli Navali, Babak Hajipour. **Comparison Of Direct Visual Inspection (DVI) With Pap Smear In Diagnosis Of Precancerous Lesion Of Cervix** *Life Sci J* 2012;9(4):2556-2560] (ISSN:1097-8135). <http://www.lifesciencesite.com>. 379

Key word: Direct visual inspection, Pap smear, Cervix.

1. Introduction

Cervix cancer is one of the most important female genitalia cancers. Not only the most common gynecological malignancy in the world, but also is the 3rd prevalent cancer in female after breast and colorectal cancers. This disease is more prevalent in under developing countries and 78% of its cases happen in these areas; and the reason is, lack of effective screening programs¹⁻³.

In the East Azerbaijan of Iran the incidence of cervix cancer in 2003-2004 was reported as 5.11 in 100000, and incidence of high grade pre-malignant lesions of cervix was 11.9 in 100000 and with low grade pre-malignant lesions the incidence was 3.68 in 100000⁴.

The main oncogenic factor that transmits via sexual contact to the cervix is human papilloma virus (HPV), which has a role in inducing pre-malignant lesions or intraepithelial neoplasias of cervix (CIN). HPV genome has been detected in all neoplasias of cervix. HPV infection usually does not stay stable and in most women, infection resolves in 9 to 15 months. Minority of women exposed to HPV develop a persistent infection and progress to CIN⁵.

There is a usually long period of pre-malignancy before formation of invasive cancer of cervix, which is microscopically, has a different range of progressive events from cellular atypia to varying degrees of dysplasia or CIN⁵.

Using screening methods and specially Pap smear in the United States has reduced the prevalence of cervix cancer up to 79% and its mortality up to 70% since 1950⁵.

A single Pap smear has a sensitivity of about 50% to 60% which means having a single Pap smear in most of the women, will not show the cervix lesions¹. About 30% of new cases of cervix cancer, every year, are the women who had Pap smear but due to errors in sampling, fixation or interpretation have been reported incorrectly normal⁵. Against the effectiveness of cytological programs of cervix, the Pap smear has lots of limitations³.

Direct visual inspection (DVI) is the other method for screening cervical pre-malignant lesion with high sensitivity (90%) and specificity (94.6%). DVI has high positive predictive value⁶.

In this study, we assumed that the direct visual inspection is equal or more capable to detect abnormal lesions of cervix in comparison to Pap smear, and its

usage is easier and affordable in different regions of our country. General purpose of this survey is comparing the direct visual inspection of cervix with Pap smear in diagnosing pre-malignant lesions of cervix.

2. Material and Methods

This was a cross sectional study on 1500 women, voluntaries or referred by doctors or health care centers, visited the Alzahra and Taleghani hospitals for screening cervix cancer and its pre malignant lesions. Pregnant and women who had a history of pre malignant or malignant lesions of cervix were excluded from the study.

Everyone who included in the study went on the gynecology bed and in lithotomic position, her cervix exposed with one time usable spatula and the Pap smear taken with spatula from exocervix cellules, also from endocervix by brushing, then they expanded on a lamella and fixed with 95% alcohol. Then cotton impregnated with 5% acetic acid placed on the cervix for a minute, and after removing the cotton, the cervix observed under the adequate light.

The findings of direct visual inspection of cervix were registered as bellow:

1. Abnormal findings in cervix same as invasive cancer, polyps, leukoplakia, condyloma cervicitis.
2. Presence or absence of acetowhite region in the cervix.
3. The expansion of acetowhite region if it exists.

When there was no acetowhite lesion, DVI was reported negative.

The DVI was reported positive when opaque acetowhite lesions with sharp borders near to SCJ were seen. Some times after using acetic acid TZ had a very light discoloration which was lucent and had no sharp borders, these cases considered negative. If the DVI was positive the colposcopy done in the same visit and if it was necessary biopsy as the gold standard of cervix assessment taken.

The Pap results were reported after a week via pathologic centers of hospitals, and if they were positive an appointment for colposcopy was made.

Cytology considered positive in bellow situations:

Invasive cancer, ASC-US, ASC-H, LSIL, HSIL

Statistic analysis:

Continuous data with normal distribution are given as mean \pm standard deviation, otherwise as median, student t test for testing the significance of mean for independent continuous scale data, Chi-square or Fisher exact test for testing the significance of percentages. A *p* value of 0.05 or less was considered significant.

3. Results

1500 women ,voluntaries or referred by doctors or health care centers, who had come to the Pap smear

centers of Alzahra and Taleghani hospitals ,went under the Pap smear and direct visual inspection (DVI) of cervix after using acetic acid .

The mean age of cases was 36.63 ± 9.7 (18-80). Half of the patients had less than 36 years of age.

No one was single or pregnant, 81.2% of women had husband and 18.8% was divorced or was widowers and there for had no sexual intercourse. 1187 (79.1%) women were educated and 313 (20.9%) were illiterate.

The mean age of women in their first intercourse was 17.92 ± 2.42 . 901 of the study group (60.1%) had no problem and just wanted to have Pap smear and 39.9% had came due to a problem in their genitalia or they just declared their problem in history taking before screening.

Through these objections backache with 38.7% had the highest rate. The other objections were :lower abdominal pain(28.7%), bleeding between the menses (14.5%), painful intercourses(11.9%), lesions in the external ano-genitalia(8.9%), menorrhagia(8%), pruritus in external ano-genitalia (6.9%) and post coital bleeding (3%).

The results reported from evaluating the Pap smears of studied cases were as follow:

1251 cases (83.4%) were normal and had no finding, 48 cases (3.2%) had atrophy, 57 cases (3.8%) had benign changes, 25 cases (1.7%) had edema, 59 cases (3.9%) had fungus ,49 women (3.3%) had bacteria, 3 person (0.2%) had bacteria plus benign reactive changes, 1 case (.1%) had atrophy plus mild edema, 6 person (0.4%) had ASCUS and 1 woman (0.1%) had CIN₁.

Table 1: problem in history taking before screening

Problems	percentage
backache	38.7%
Lower abdominal pain	28.7%
Bleeding between the menses	14.5%
Painful intercourses	11.9%
lesions in the external ano-genitalia	8.9%
menorrhagia	8%
pruritus in external ano-genitalia	6.9%
post coital bleeding	3%

Table 2: The results reported from evaluating the Pap smears

Pap smear result	Percentage
No finding	83.4%
atrophy	3.2%
benign changes	3.8%
edema	1.7%
fungus	3.9%
bacteria	3.3%
bacteria plus benign reactive changes	0.2%
atrophy plus mild edema	1%
ASCUS	0.4%
CIN ₁	0.1%

From the mentioned cases due to the aim of our study 1493 (99.5%) cases were healthy and 7 cases that had ASCUS or CIN₁ considered positive and checked with colposcopy and biopsy taken from them.

Of these 7 cases only 3 get proofed as a premalignant lesion, with colposcopy and biopsy. And 4 cases had some changes in their cervix due to acute or chronic cervicitis which the Pap smear had reported them as ASCUS. The 3 cases which were diagnosed as ASCUS or CIN₁, through Pap smear and also biopsy had proofed their pre malignancy, were positive with DVI too.

But from 4 false positive cases of Pap smear only 1 had a positive DVI.

Of the 1500 cases only 9 cases had positive DVI whom went under the colposcopy and biopsy.

Of the 9 positive DVI cases, biopsy and colposcopy proofed 8 cases as pre- malignant or malignant lesions, so that 2 cases were invasive cancer (with negative Pap), 3cases CIN₁ (1 was reported negative in Pap and 1case as CIN and the other one was reported as ASCUS) and 2 cases were CIN₂ (one had a negative Pap and one was reported as ASCUS) and one case was CIN₃ which had negative pap smear.

Of the 8 cases which the pre-malignant or malignant lesions have been proofed by colposcopy and biopsy, 3 had no objection about their genital system (CIN₃-CIN₂-CIN₁), 2 women complained of excessive vaginal bleeding during menstruation period (CIN₂-CIN₁), and 3 had post coititious bleeding (2cases of invasive cancer and 1 case of CIN₁).

Test efficiency parameters particularly sensitivity, specificity, and positive predictive values of DVI were 88.8%, 99.9% and 88.8%, respectively; those of Pap smear were 37.5%, 99.06%, 42.85%, respectively.

Discussion:

One of the important health problems in many developing countries is cervical cancer⁷ which is the second most common cancer among women worldwide^{8,9} so that approximately 450,000 new cases of cervical neoplasm are diagnosed each year in the world¹⁰.

The cervical cancer incidence is higher in countries where screening programs are poorly^{11,12}. One of the major causes of cervical cancer remains the most common cause of cancer deaths among women in developing countries is failure of screening programs in these countries¹³.

Many cases of cervical cancer are preventable by screening programs. Some studies in developed countries demonstrate can be reduced by screening¹⁴⁻¹⁸.

There are several methods to screen for cervical cancer. One of these methods is direct visual

inspection of the cervix after the application of 5% acetic acid (DVI).

Because of its ability to in detecting cervical cancer is nearly equivalent to cervical cytology some studies have recommended this method¹⁹⁻²³. This method is cost effective and justified for screening²⁴. Another successful method for cervical cancer screening is Pap smear⁹.

The current study was designed to compare the DVI and Pap smear in diagnosis of precancerous lesions of cervix.

Recent studies have shown direct visual inspection (DVI) has high sensitivity for detecting the premalignant cervix lesions^{6,13,25} for example, in Denny et al survey, 2754 women were screened by DVI that can be diagnosed 70% of cases of high-grade SILs (CIN Grade 2, 3) in this study¹³.

Another study with equivalent design has done in Egypt; DVI had a sensitivity of 85% for pre-malignant lesions compared with 16.9% for cervical cytology²⁵. However, sensitivity of DVI was reported from 75% to 100% in several studies^{6,13,25-27}. Our results confirm these finding because in our study, sensitivity of DVI was 88.8%.

Sensitivity of the Pap smear in detecting pre-malignant lesions has been reported between 16 to 85 percent^{6,25,27-29}. In this study, sensitivity of Pap smear was 37.5%.

The specificity of the Pap smear is more than DVI, although its sensitivity is less than DVI^{6,25}. In De Vuyst et al survey, specificity of Pap smear (94.6%) was higher compared to that of DVI (80%)³⁰. In our study, specificity of Pap smear and DVI were 99.06% and 99.9%, respectively.

In several studies, positive predictive value of Pap smear has been reported lower than direct visual inspection (DVI)^{25,29}. Our results confirm these finding because in our study and PPV of DVI is better than Pap smear (PPV of Pap smear and DVI were 42.85% and 88.8%, respectively).

Sensitivity and specificity of DVI is higher than Pap smear and its cost effective^{13,25,26}. In our study, these results obtained, so we suggest direct visual inspection can be used as a primary screening tool with a satisfactory low biopsy rate in developing countries.

Conclusion:

Current survey shows that we can use a simple and inexpensive method to find malignant and pre-malignant lesions of cervix. Especially in the societies which there are not all the conditions resulting in effectiveness of screening methods such as Pap smear, in reducing the prevalence and mortality of cervix cancer, using a simple diagnostic method like DVI for all cases and referring the suspected ones to get final diagnose and be treated is critical. Direct visual

inspection (DVI) is feasible and easy to perform with superior sensitivity and specificity to Pap smear in detecting cervical premalignant and malignant lesions.

It seems that the important and basically problems which if be solved can reduce the cervix cancer are unconsciousness of most society people ,with any socioeconomically levels ,about the importance of screening and its method also the risk factors of this cancer such as smoking and unsafe sexual relations.

References:

- Dennis S, Nadeem R, Abu-Rustam, Plante M, Roy M. Te lind's operative Gyne cology, tenth edition. Lippincott Williams & Wilkins, Philadelphia, 2008; 1208-1227.
- Veena S, Ashok S, Usha K. screening for cervical cancer by direct inspection. *BMJ*, 1992; 304, 534.
- Singer A, Monaghan J. lower genital tract pre-cancer, second edition. Black weil science, USA, 2000;125-136.
- Dastranj Tabrizi A, Alizadeh M, Sayyah Melli M, Jafari M, Madarek E. Incidence rate of cervical cancer and precancerous lesion in east Azarbajjan, Iran. *Asian Pacific Journal of Clinical Oncology*, 2006; 2: 87.
- Berek J. Berek & Novak's Gynocology, fourteenth edition. Lippincott Williams & Wilkins, Philadelphia, 2007:561-600, 1404-1450.
- El-Shalakany A.H, Saeed M.M, Abdel-Aal M.R, El-Nakeeb A.H, Noseirat N, Ayyad S.B, El Din Z.S. direct visual inspection of the cervix with Lugol iodine for the detection of premalignant lesions. *J Low Genit Tract Dis*, 2008;12(3):193-8.
- Almonte M, Ferreccio C, Winkler J.L, Cuzick J, Tsu V, Robles S, Takahashi R, Sasieni P. Cervical screening by visual inspection, HPV testing, liquid-based and conventional cytology in Amazonian Peru. *Int J Cancer*, 2007; 121:796-802.
- Ferlay J, Bray F, Pisani P, Parkin D. M. GLOBOCAN 2002: Cancer Incidence, Mortality and Prevalence Worldwide. IARC CancerBase No. 5. Version 2.0. Lyon, IARCPress 2004.
- Laura Kotaniemi - Talonen. Randomised Evaluation of New Technologies within the Population - Based Cervical Cancer Screening Programme in Finland: Cross - Sectional Performance and Validity. Helsinki University Print Helsinki 2009.
- World Health Organization. Selected aspects of reproductive ill health: 1990–1995. Available from URL: <http://www.who.int/rht/rhtdimensions.htm> [accessed November 1, 1999].
- Parkin D.M, Pisani P, Ferlay J. Estimates of the worldwide incidence of eighteen major cancers in 1985. *Int J Cancer*, 1993;54(4):594–606.
- Denny L, Kuhn L, Pollack A, Wainwright H, Wright T.C. Evaluation of Alternative Methods of Cervical Cancer Screening for Resource-Poor Settings. *Cancer*, 2000; 89, 826–33.
- Denny L, Kuhn L, Pollack A, Wright T.C. Direct Visual Inspection for Cervical Cancer Screening. *An Analysis of Factors Influencing Test Performance*. *Cancer*, 2002; 94, 1699–707.
- IARC Working Group on Cervical Cancer Screening. Summary chapter. In: Hakama M, Miller AB, Day NE, editors. Screening for cancer of the uterine cervix. Lyon: International Agency for Research on Cancer, 1986; 133–142.
- Laara E, Day N.E, Hakama M. Trends in mortality from cervical cancer in the Nordic countries: association with organised screening programmes. *Lancet*, 1987;30:1247–1249.
- IARC Working Group on Evaluation of Cervical Cancer Screening Programmes. Screening for squamous cervical cancer: the duration of low risk after negative result of cervical cytology and its implication for screening policies. *Br Med J*, 1986;293: 659–664.
- Hakama M, Louhivuori K. A screening programme for cervical cancer that worked. *Cancer Surveys*, 1988;17(3) 403– 416.
- Parkin DM. Screening for cervix cancer in developing countries. In: Miller AB, Chamberlain J, Day NE, Hakama M, Prorok PC, editors. Cancer screening. Cambridge: Cambridge University Press, 1991:184–198.
- Megevand E, Denny L, Dehaeck K, Soeters R., Bloch B. Acetic acid visualisation of the cervix: an alternative to cytologic screening. *Obstet Gynecol*, 1996; 88, 383–386.
- Sankaranarayanan R, Wesley R, Somanathan T, Dhakad N, Shyamalakumary B, Sreedevi Amma N. Visual inspection of the uterine cervix after the application of acetic acid in the detection of cervical carcinoma and its precursors. *Cancer*, 1998; 83, 2150–2215.
- Sankaranarayan R, Shyamalakumary B, Wesley R, Sreedevi Amma N, Parkin DM, Nair MK. Visual inspection with acetic acid in the early detection of cervical cancer and its precursors [letter to the editor]. *Int J Cancer*, 1999; 80:161–163.
- University of Zimbabwe/JHPIEGO Cervical Cancer Project. Visual inspection with acetic acid for cervical cancer screening: test qualities in a primary-care setting. *Lancet*. 1999;353: 869–873.
- Denny L, Kuhn L, Risi L, et al. Two-stage cervical cancer screening: an alternative for resource poor settings. *Am J Obstet Gynecol*, 2000; 183-383.
- Singh V, Sehgal A, Parashari A, Sodhani P, Satyanarayana L. Early detection of cervical cancer

- through acetic acid application--an aided visual inspection. Singapore Med J, 2001; 42:351-4.
25. El-Shalakany A, Hassan S.S, Ammar E, Ibrahim M.A, Salam M.A, Farid M. Direct visual inspection of the cervix for the detection of premalignant lesions. J Low Genit Tract Dis, 2004;8(1):16-20.
 26. Singh V, Sehgal A, Parashari A, Sodhani P, Satyanarayana L. (2001) Early detection of cervical cancer through acetic acid application--an aided visual inspection. Singapore Med J, 2001;42(8): 351-4.
 27. Akinola O.I, Fabamwo A.O, Oshodi Y.A, Banjo A.A, Odusanya O, Gbadegesin A, Tayo A. Efficacy of visual inspection of the cervix using acetic acid in cervical cancer screening: a comparison with cervical cytology. J Obstet Gynaecol, 2007; 27(7):703-5.
 28. Cronje H.S, Parham G.P, Cooreman B.F, de Beer A, Divall P, Bam R.H. A comparison of four screening methods for cervical neoplasia in a developing country. Am J Obstet Gynecol, 2003;188 (2): 395-400.
 29. Jeronimo J, Morales O, Horna J, Pariona J, Manrique J, Rubiños J, Takahashi R. Visual inspection with acetic acid for cervical cancer screening outside of low-resource settings. Rev Panam Salud Publica, 2005; 17(1): 1-5.
 30. De Vuyst H, Claeys P, Njiru S, Muchiri L, Steyaert S, De Sutter P, Van Marck E, Bwayo J, M. Comparison of pap smear, visual inspection with acetic acid, human papillomavirus DNA-PCR testing and cervicography. Int J Gynaecol Obstet, 2005; 89: 120-6.

9/6/2012

Heterologous reconstitution the polyunsaturated fatty acid biosynthetic pathway of *Phaeodactylum tricoratum* in *Arabidopsis thaliana*

Yun-tao Li^{1,2*}, Yuan-min Zhu¹, Chun-hua Fu¹, Mao-teng Li^{1**}, Long-jiang Yu¹

¹ College of Life Science and Technology, Huazhong University of Science and Technology, Wuhan, 430074, China

² College of Life Science, Hubei Normal University, Huangshi, 435002, China

** Corresponding author. Address: Institute of Resource Biology and Biotechnology, College of Life Science and Technology, Huazhong University of Science and Technology, Wuhan 430074, P.R. China. E-mail: limaoteng426@mail.hust.edu.cn. Tel.: +86 (27) 87792264; Fax: +86(27)87792265.

Abstract: The genes encoding $\Delta 6$ desaturase, $\Delta 6$ fatty acid elongase, and $\Delta 5$ desaturase from the alga, *Phaeodactylum tricoratum*, were co-expressed in *Arabidopsis thaliana* under the control of the *Brassica napus* napin promoter to produce arachidonic acid (ARA; 20:4 $\Delta^{5,8,11,14}$) and eicosapentaenoic acid (EPA; 20:5 $\Delta^{5,8,11,14,17}$). ARA and EPA accumulated up to 0.5% and 0.05% of total fatty acids, respectively, in the transgenic *A. thaliana*. The conversion efficiencies of desaturation steps in n6 (18.6% and 23.8%) and n3 (6% and 9%) were different. The efficiency in n6 pathways was higher than that of in n3 pathways.

[Yun-tao Li, Yuan-min Zhu, Chun-hua Fu, Mao-teng Li, Long-jiang Yu. **Heterologous reconstitution the polyunsaturated fatty acid biosynthetic pathway of *Phaeodactylum tricoratum* in *Arabidopsis thaliana***. *Life Sci J* 2012;9(4):2561-2565] (ISSN:1097-8135). <http://www.lifesciencesite.com>. 380

Keywords: Desaturase; Elongase; Arachidonic acid and eicosapentaenoic acid; *Arabidopsis thaliana*; Transformation

1. Introduction

Polyunsaturated fatty acids (PUFAs), such as arachidonic acid (ARA; 20:4 $\Delta^{5,8,11,14}$) and eicosapentaenoic acid (EPA; 20:5 $\Delta^{5,8,11,14,17}$), are essential for human health and well-being. They can maintain the structure and function of bio-membrane (1). They also have important physiological and medical functions, such as curing of cardiovascular disease anti-inflammatory (2) and promoting brain development (3). Recently people have paid more attention to ARA, EPA and docosahexaenoic acid (DHA; 22:6 $\Delta^{4,7,10,13,16,19}$) than other PUFAs because of their special role and influence on human health. At present, the main source of EPA and DHA for human consumption is oily ocean fish (4). The γ -linolenic acid (GLA; 18:3 $\Delta^{6,9,12}$) can be found in plant oils derived from evening primrose, borage and black currant (5). ARA is commercially produced by fermentation of oleagenous fungi such as *Mortierella alpina* (6). The increasing demand has raised the interest in obtaining these PUFAs from alternative sources, which are more economical and sustainable than traditional source. One attractive option is to genetically engineer the oil-seed crops like soybean, rape, and others to produce long-chain PUFAs such as GLA, ARA, EPA, and DHA (7).

The production of PUFA such as ARA, EPA and DHA in oilseed crops has been the subject of much recent interest. Abbadi et al. reported 1.5% AA and 1.0% EPA in transgenic flax seeds containing $\Delta 6$ and $\Delta 5$ desaturases and a $\Delta 6$ elongase (8). However, in *Brassica juncea*, the introduction of 5 and 9 structural

genes resulted in the production of up to 25% AA and 15% EPA in transgenic seeds (9). Robert et al. used the *Arabidopsis thaliana* as the host plant for biosynthesis of PUFAs using a construct including a dual-purpose $\Delta 5/\Delta 6$ desaturase that acts on acyl-CoA substrates, the production of EPA and AA was 3.2% and 1.6% respectively in transgenic *Arabidopsis* (10). It is clear that some endogenous metabolic bottlenecks need to be overcome to enable transgenic plants to synthesize and accumulate PUFAs to levels equivalent to those found in the marine environment (11, 12, 13). Several different metabolic engineering rationales to increase PUFA production in transgenic seed oils have been suggested. One approach is to find superior desaturases can efficiently use acyl-CoA substrates (11). For example, $\Delta 6$ -desaturases from liverwort, *Marchantia polymorpha* and *Mantoniella squamata* can efficiently use acyl-CoA substrates, potentially bypassing the acyl-exchange bottleneck (14, 15, 16). Taken together, these results indicate that both the specific gene combinations used and the choice of host plant are important for VLCPUFA production (17).

In previous, our team has researched the influence of gene copy number on the yield of PUFAs using the $\Delta 6$, $\Delta 5$ desaturase and $\Delta 6$ elongases from *Phaeodactylum tricoratum* in *Pichia pastoris*. Recently our team identified the $\Delta 6$ desaturase gene from *M. alpina* W15 (18). In the present study, we report the seed-specific expression of $\Delta 6$ desaturase (D6), $\Delta 5$ desaturase (D5) (19), and $\Delta 6$ elongases (E6) (GenBank accession no. [AY746355](http://www.ncbi.nlm.nih.gov/nuccore/AY746355)) from *P. tricoratum* in *Arabidopsis thaliana* to reconstituted the biopathways for EPA and

ARA.

2. Materials and methods

Plant materials

P. tricornutum was grown in f/2 culture medium at 22 °C with photoperiods of 16 h of light, *A. thaliana* ecotype Columbia was grown at 22 °C and used for transformation. *Brassica napus* of B351 which provided by Shanxi Hybrid Rapeseed Research Centre of China was used for the cloning of napin promoter.

Nucleic acids extractions

Total genomic DNA was extracted from leaves of *B. napus* and seedlings of *A. thaliana* using a CTAB method (20). *P. tricornutum* in the logarithmic phase was collected by centrifugation and used for the extraction of total RNA (21). The total RNA of *P. tricornutum* was extracted using RNeasy Maxi Kit (Qiagen, Valencia, CA).

Vector construction

The sequence of napin promoter and the open reading frames of the different desaturases and elongase were modified by PCR to create appropriate restriction sites adjacent to the start codons and stop codons, cloned into the pGEMT-T vector (Promega, Madison, WI), and sequenced to confirm their identity.

For the generation of transformation constructs, a triple cassette containing the napin promoter, the NOS terminator, and three different polylinkers between each promoter and terminator were first inserted into the pUC18 vector, yielding the pUC18np plasmid.

The open reading frames of desaturases and elongases were then released using the restriction sites created by PCR and successively inserted into the same restriction sites of the polylinkers of the pUC18np plasmid, yielding the pUC18123np plasmid. The resulting cassette, containing the three genes each under the control of the napin promoter, was released by digesting the pUC18123np plasmid with *KpnI* and *BglII* and cloned into the corresponding sites of the binary vectors pCAMBIA1303 (CAMBIA, Canberra, Australia), yielding the pC1303D6E6D5 plasmid. The vectors pC1303D6E6D5 were transferred into the *Agrobacterium* strain LBA4404.

Plant transformation

A. thaliana transformation was carried out by the floral dipping method of Clough and Bent (22). Seeds from dipped plants (T₁ seed) were collected and plated out on selective media containing hygromycin (40 mg/L). The selected transformed seedlings were transferred to soil to establish T₁ plants.

Molecular analysis of transgenic plants

Transgenic plants were checked by PCR amplification on genomic DNA. In order to detect the expression of target genes, RT-PCR were performed. Total RNAs were isolated from transformant and first-strand cDNAs were synthesized using the First Strand cDNA Synthesis Kit (Fermentas). These

templates were used for the amplification of target gene using the same primer sets as those used in genomic PCR.

Fatty acid extraction and analysis

Total seed oil was extracted by a method as previously described (23). The fatty acid methyl esters (FAMES) were prepared according to Lightner et al. (24) and analyzed by gas chromatography-mass spectrometry (GC-MS) using an Agilent 7890A-5975C GC-MS Network system.

3. Results

Construction of plant expression vectors and molecular analysis of transgenic plants

Restriction and PCR analysis of the resultant clones identified trivalent expression vectors containing *D6*, *E6*, *D5* expression cassette, and the result showed that trivalent expression vectors were successfully constructed (Figure 1).

Hygromycin-resistant seedling lines were obtained after selection in a medium supplemented with increasing concentrations of hygromycin B from 15–45 mg/mL. Genomic PCR analysis revealed that some of the seedlings contained the genes of *D6*, *D5* desaturase, and *E6* elongase, while the others contained only one or two genes of them.

RT-PCR analysis showed that plant integrated by the genes of *D6*, *D5* desaturase, and *E6* elongase contained the transcripts of the three genes. And the transcripts of the three genes were detected only in the T₁ plant's seeds suggested that the three genes were only expressed in seeds (Figure 2).

Fatty acid analysis of transgenic plants

Following transformation with the trivalent expression vectors and selection on hygromycin, T₁ plants were recovered and their seeds were analyzed for fatty acid composition using GC-MS (Figure 3). The result showed that new n3 PUFA, including stearidonic acid (SDA; 18:4 $\Delta^{6,9,12,15}$), eicosatetraenoic acid (ETA; 20:4 $\Delta^{8,11,14,17}$) and EPA, and new n6 PUFA, including GLA, dihomo- γ -linolenic acid (DGLA; 20:3 $\Delta^{8,11,14}$) and ARA were synthesized in T₁ plants, conversely these productions were not detected in wild type *A. thaliana*. Thus it is concluded that ARA and EPA biosynthetic pathways were successfully reconstituted in *A. thaliana*.

The fatty acids of the transgenic *A. thaliana* were shown in Table 1. The contents of GLA, DGLA and ARA were 6.2 %, 1.6 % and 0.5 % respectively. The yields of SDA, ETA and EPA accumulated to 0.9 %, 0.5 % and 0.05 %, respectively. The contents of LA and ALA, especially eicosenoic acid (ENA; 20:1 Δ^{11}), were decreased in transgenic *A. thaliana* comparing with the wild type. The decrease of the LA, ALA and ENA contents in transgenic plants indicated that these heterologous genes which were transformed into *A. thaliana* had significant influence on the fatty acid

composition of *A. thaliana*. The conversion efficiency of each step in the n6 and n3 pathways was calculated as products/ (substrate + products). These results showed that the conversion efficiency of desaturation step in n6 (18.6% and 23.8%) was higher than in n3 pathways (6% and 9%) (Table 2). The low conversion efficiency in n3 pathways is partly because of the low content of EPA.

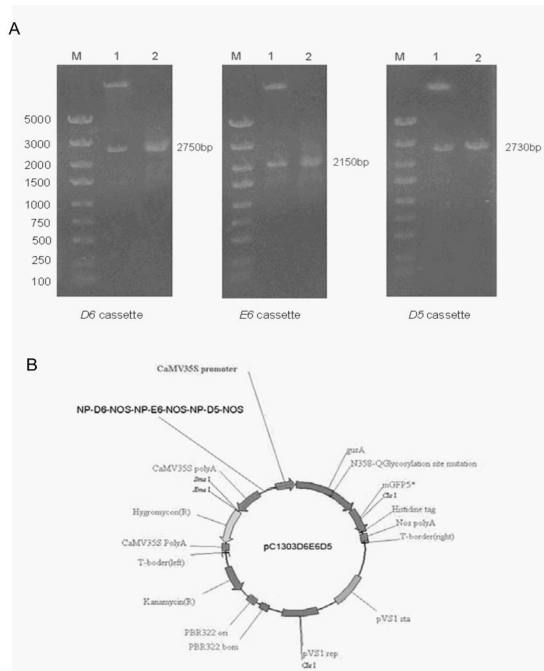

Figure 1. A: Restriction analyses of pC1303D6E6D5. M: marker; lane 1: digested recombinant plasmid; lane 2: PCR product of target gene expression cassette. B: The trivalent expression vector.

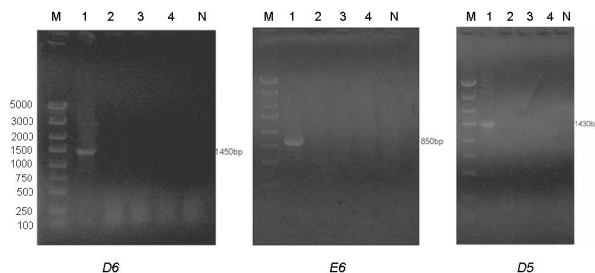

Figure 2. RT-PCR results of transgenic *A. thaliana*. M: marker; lane 1: seed; lane 2: root; lane 3: stem; lane 4: leaf; N: negative control.

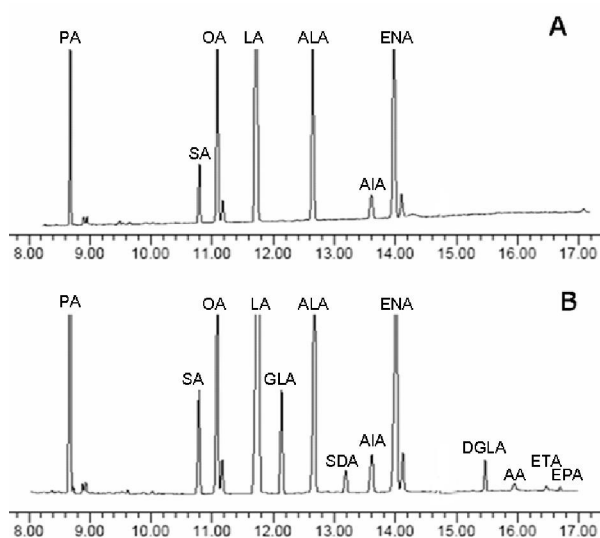

Figure 3. Results of GC-MS analysis of fatty acids in transgenic *A. thaliana*. A, B represent the fatty acids in the wild type and transgenic *A. thaliana* respectively.

Table 1. Fatty acid composition (% w/w) of total fatty acids from transgenic *A. thaliana*.

Fatty acid	<i>A. thaliana</i>	transgenic <i>A. thaliana</i>
PA ^a 16:0	9.7±0.3 ^b	10.1±0.3
SA 18:0	4.3±0.2	6.7±0.2
OA 18:1 Δ^9	16.6±0.5	15.8±0.5
LA 18:2 $\Delta^{9,12}$	28.2±0.6	27.1±0.5
ALA 18:3 $\Delta^{9,12,15}$	17.2±0.5	14.0±0.4
AIA 20:0	2.2±0.1	1.7±0.1
ENA 20:1 Δ^{11}	19.7±0.4	10.8±0.3
GLA 18:3 $\Delta^{6,9,12}$	ND ^c	6.2±0.4
DGLA 20:3 $\Delta^{8,11,14}$	ND	1.6±0.2
ARA 20:4 $\Delta^{5,8,11,14}$	ND	0.5±0.1
SDA 18:4 $\Delta^{6,9,12,15}$	ND	0.9±0.2
ETA 20:4 $\Delta^{8,11,14,17}$	ND	0.5±0.1
EPA 20:5 $\Delta^{5,8,11,14,17}$	ND	0.05±0.0

^aPA: palmitic acid; SA: stearic acid; OA: Oleic acid; LA: linoleic acid; ALA: α -linolenic acid; AIA: arachidonic acid; ENA: eicosenoic acid; GLA: γ -linolenic acid; DGLA: dihomo- γ -linolenic acid; ARA: arachidonic acid; SDA: stearidonic acid; ETA: eicosatetraenoic acid; EPA: eicosapentaenoic acid.

^bEach value is the mean \pm SD from three independent experiments

^cNot detected

Table 2. Conversion efficiency (%) of *P. tricornutum* PUFAs biosynthetic enzymes in transgenic *A. thaliana*.

$\Delta 6$ -des		$\Delta 6$ -elo		$\Delta 5$ -des	
LA→GLA	ALA→SDA	GLA→DGLA	SDA→ETA	DGLA→ARA	ETA→EPA
18.6 ^a	6.0	20.5	35.7	23.8	9

^a The conversion efficiency of each step was calculated as $100 \times \text{product}/(\text{substrate} + \text{product})$ (%)

4. Discussion

In this study, the content of EPA (n3) was lower than that of ARA (n6) in transgenic *A. thaliana*, thus the conversion efficiency of n6 pathways was higher than that of n3 pathways overall. It is partly because of the low content of EPA. The genes of $\Delta 6$ desaturase, $\Delta 5$ desaturase, and $\Delta 6$ elongases were from *P. tricornutum*. The content of EPA was much higher than ARA in *P. tricornutum*. Maybe there was some kind of mechanism by which ARA can be converted to EPA. Recently, some researchers reported that the seed-specific expression of a $\Delta 9$ elongase pathway consisted of the *Isochrysis galbana* $\Delta 9$ elongase, the *Pavlova salina* $\Delta 8$ and $\Delta 5$ desaturases in *A. thaliana* and *B. napus*, furthermore the contents of ARA and EPA were 9.7% and 2.4%, respectively in T₂ transgenic *B. napus* seed (25). The efficiency of $\Delta 9$ elongase pathway was higher than that of conventional $\Delta 6$ -pathway, but in the both pathway the content of ARA was much higher than that of EPA. In other study, the content of ARA was higher than that of EPA, too (26).

To obtain a suitable and alternative source of these desired PUFAs, producing PUFAs in the oil-bearing crops would be a preferable alternative. The fatty acids mainly synthesized in the seeds. Napin promoter can control the expression of heterologous genes which were specifically expressed in seeds, prevent foreign gene expression in other parts of the plant, reduce the waste of plant energy and nutrients, and reduce the adverse effects of transformation heterologous genes on plants. So napin promoter was often used in transformation of *A. thaliana* and *B. napus*. *P. tricornutum* has high levels of EPA, and its content exceeds 30% (27). *P. tricornutum* was possibly a good genetic source material. In transgenic *A. thaliana*, the conversion efficiencies of each step in the n6 and n3 pathways were low, so the content of ARA and EPA were low, too. The result showed that heterologous expression of the genes from some material which has high levels of PUFAs may not produce high levels of PUFAs in transgenic material. Hence, it is necessary to take other method to obtain high lever ARA and EPA. For example, using the $\Delta 9$ elongase pathway or acyl-CoA-dependent pathway, or using the lyso-phosphatidylcholine acyltransferases gene was optional methods.

Acknowledgements

The investigation was supported by the Key technologies research and development program of Wuhan (201020622246), National Natural Science Foundation of China (Grant No.20776058), the Natural Science Funds for Distinguished Young Scholars of Hubei Province (2010CDA097), the New Century Talents Support Program by Ministry of Education of China and National High Technology Research and Development Program of China (2007AA10Z120). The authors are grateful to Ms Cheng of Huazhong University of Science & Technology analytical and testing center for technical assistance.

Corresponding author:

Dr. Mao-teng Li

Institute of Resource Biology and Biotechnology, College of Life Science and Technology, Huazhong University of Science and Technology, Wuhan, Hubei 430074, P.R. China

E-mail: limaoteng426@mail.hust.edu.cn

Tel.: +86 (27) 87792264; Fax: +86(27)87792265.

References

1. Yehuda S, Rabinovitz S, Carasso LR, Mostofsky DI. The role of polyunsaturated fatty acids in restoring the aging neuronal membrane. *Neurobiol Aging* 2002; 23: 843-853.
2. Das UN. Estrogen, statins, and polyunsaturated fatty acids: similarities in their actions and benefits: is there a common link? *Nutrition* 2002; 18:178-188.
3. Benatti P, Peluso G, Nicolai R, Calvani M. Polyunsaturated fatty acids: biochemical, nutritional and epigenetic properties. *J Am Coll Nutr* 2004; 23: 281-302.
4. Pauly D, Christensen V, Guénette S, Pitcher TJ, Sumaila UR, Walters CJ, Watson R, Zeller D. Towards sustainability in world fisheries. *Nature* 2002; 418: 689-695.
5. Barre DE. Potential of evening primrose, borage, black currant, and fungal oils in human health. *Ann Nutr Metab* 2001; 45: 47-57.
6. Streekstra H. On the safety of *Mortierella alpina* for the production of food ingredients, such as arachidonic acid. *J Biotechnol* 1997; 56: 153-165.

7. Huang YS, Pereira SL, Leonard AE. Enzymes for transgenic biosynthesis of long-chain polyunsaturated fatty acids. *Biochimie* 2004; 86: 793-798.
8. Abbadi A, Domergue F, Bauer J, Napier JA, Welti R, Zähringer U, Cirpus P, Heinz E. Biosynthesis of very-long-chain polyunsaturated fatty acids in transgenic oilseeds: constraints on their accumulation. *Plant Cell* 2004; 16:1-15.
9. Wu G, Truksa M, Datla N, Vrinten P, Bauer J, Zank T, Cirpus P, Heinz E, Qiu X. Stepwise engineering to produce high yields of very long-chain polyunsaturated fatty acids in plants. *Nat Biotechnol* 2005; 23:1013-1017.
10. Robert SS, Singh SP, Zhou XR, Petrie JR, Blackburn SI, Mansour PM, Nichols PD, Liu Q, Green AG. Metabolic engineering of *Arabidopsis* to produce nutritionally important DHA in seed oil. *Funct Plant Biol* 2005; 32:473-479.
11. Ruiz-López N, Haslam RP, Venegas-Calderón M, Li T-b, Bauer J, Napier JA, Sayanova O. Enhancing the accumulation of omega-3 long chain polyunsaturated fatty acids in transgenic *Arabidopsis thaliana* via iterative metabolic engineering and genetic crossing. *Transgenic Res* 2012; DOI 10.1007/s11248-012-9596-0.
12. Venegas-Calderón M, Sayanova O, Napier JA. An alternative to fish oils: metabolic engineering of oil-seed crops to produce omega-3 long chain polyunsaturated fatty acids. *Prog Lipid Res* 2010; 49:108-119.
13. Napier JA, Graham IA. Tailoring plant lipid composition: designer oilseeds come of age. *Curr Opin Plant Biol* 2010; 13: 330-337.
14. Kajikawa M, Yamato KT, Kohzu Y, Nojiri M, Sakuradani E, Shimizu S, Sakai Y, Fukuzawa H, Ohyama K. Isolation and characterization of $\Delta 6$ -desaturase, an ELO-like enzyme and $\Delta 5$ -desaturase from the liverwort *Marchantia polymorpha* and production of arachidonic and eicosapentaenoic acids in the methylotrophic yeast *Pichia pastoris*. *Plant Mol Biol* 2004; 54:335-352.
15. Hoffmann M, Wagner M, Abbadi A, Fulda M, Feussner I. Metabolic engineering of $\omega 3$ -very long chain polyunsaturated fatty acid production by an exclusively acyl-CoA-dependent pathway. *J Biol Chem* 2008; 283:22352-22362.
16. Petrie JR, Shrestha P, Mansour MP, Nichols PD, Liu Q, Singh SP. Metabolic engineering of omega-3 long-chain polyunsaturated fatty acids in plants using an acyl-CoA $\Delta 6$ -desaturase with omega3-preference from the marine microalga *Micromonas pusilla*. *Metab Eng* 2010; 12:233-240
17. Cheng BF, Wu GH, Vrinten P, Falk K, Bauer J, Qiu X. Towards the production of high levels of eicosapentaenoic acid in transgenic plants: the effects of different host species, genes and promoters. *Transgenic Res* 2010; 19:221-229.
18. Liu JM, Li DR, Yin YT, Wang H, Li MT, Yu LJ. $\Delta 6$ -Desaturase from *Mortierella alpina*: cDNA cloning, expression, and phylogenetic analysis. *Biotechnol Lett* 2011; 33: 1985-1991.
19. Domergue F, Lerchl J, Zähringer U, Heinz E. Cloning and functional characterization of *Phaeodactylum tricornutum* front-end desaturases involved in eicosapentaenoic acid biosynthesis. *Eur J Biochem* 2002; 269: 4105-4113.
20. Kang TJ, Yang MS. Rapid and reliable extraction of genomic DNA from various wild-type and transgenic plants. *BMC Biotechnol* 2004; 4:20. doi: 10.1186/1472-6750-4-20.
21. Shirley BW, Hanley S, Goodman HM. Effects of ionizing radiation on a plant genome: analysis of two *Arabidopsis* transparent testa mutations. *Plant Cell* 1992; 4: 333-347.
22. Clough SJ, Bent AF. Floral dip: a simplified method for *Agrobacterium*-mediated transformation of *Arabidopsis thaliana*. *Plant J* 1998; 16: 735-743.
23. Tonon T, Harvey D, Larson TR, Graham IA. Identification of a very long chain polyunsaturated fatty acid $\Delta 4$ -desaturase from the microalga *Pavlova lutheri*. *FEBS Lett* 2003; 553: 440-444.
24. Lightner J, Lark E, James D, Browse J. Novel mutations affecting leaf stearate content and plant size in *Arabidopsis*. *Theor Appl Genet* 1997; 94: 975-981.
25. Petrie JR, Shrestha P, Belide S, Mansour MP, Liu Q, Horne J, Nichols PD, Singh SP. Transgenic production of arachidonic acid in oilseeds. *Transgenic Res* 2012; 21: 139-147.
26. Qi BX, Fraser T, Mugford S, Dobson G, Sayanova O, Butler J, Napier JA, Stobart AK, Lazarus CM. Production of very long chain polyunsaturated omega-3 and omega-6 fatty acids in plants. *Nat. Biotechnol* 2004; 22: 739-745.
27. Yongmanitchai W, Ward OP. Growth of and omega-3 fatty acid production by *Phaeodactylum tricornutum* under different culture conditions. *Appl. Environ Microbiol* 1991; 57: 419-425.

10/30/2012

Detection of *campylobacter* spp. in stool samples by new methods in comparison to culture

Mona Z Zaghloul, Naglaa Farouk and Zeinab Ali Galal

Clinical Pathology Department, Faculty of Medicine, Ain Shams University, Cairo, Egypt
monazaki_810@hotmail.com

Abstract: *Campylobacter* enteritis is a food-borne or waterborne illness caused by *Campylobacter jejuni* and, to a lesser extent, by *Campylobacter coli*. The aim of this study to compare *Campylobacter* spp. detection by molecular method (multiplex polymerase chain reaction) and by 2 immunoenzymatic methods (Premier CAMPY and ImmunoCard Stat Campy) to the culture on Skirrow's medium. **Subjects and methods:** In this study 350 stool specimens were collected from patients suffering from gastroenteritis manifestations with a mean age of 58.5 years. Faecal samples were subjected to culture on Skirrow's selective media, multiplex PCR and 2 immunoenzymatic methods, Premier CAMPY ELISA and ImmunoCard Stat Campy. **Results:** Out of 350 stool specimens tested, 23 (6.6%) fulfilled the positivity criteria, i.e., they were positive by culture method or, in case of a negative culture, by a positive molecular method and a positive immunoenzymatic method, 16 were positive by culture and 7 were culture negative but positive by both a molecular method (multiplex PCR) and an immunoenzymatic method. The *Campylobacter* species identified by culture were 10 (62.5%) *C. jejuni* and 6 (37.5%) *C. coli* while multiplex PCR identified 13 (56.5%) *C. jejuni*, 8 (34.8%) *C. coli* and 2 (8.7%) as mixed *C. jejuni* and *C. coli*. The sensitivity of the multiplex PCR was higher than the ELISA and ImmunoCard Stat Campy tests (100%, 95.6% and 86.9% respectively) while the ImmunoCard Stat Campy had higher specificity than the ELISA and multiplex PCR (98.7%, 98.1% and 97.9 % respectively). **Conclusion:** Multiplex PCR is attractive as it enables the detection and speciation of *campylobacter*. Also the procedure of the multiplex PCR had a rapid turnaround time of 6 h. The Premier CAMPY ELISA was rapid and had acceptable performance sensitivity of 95.6%.

[Mona Z Zaghloul, Naglaa Farouk and Zeinab Ali Galal **Detection of *campylobacter* spp. in stool samples by new methods in comparison to culture.** *Life Sci J* 2012;9(4):2566-2571]. (ISSN: 1097-8135).
<http://www.lifesciencesite.com>. 381

Key words: *Campylobacter*, *Gastroenteritis*, Polymerase chain reaction, Skirrow's medium

1. Introduction

Campylobacter spp. is a major cause of bacterial gastroenteritis worldwide [1,2]. In the USA, the incidence of *C. jejuni* infections is the second largest after *Salmonella* cases [3]. The relatively low infective dose, the potentially serious sequelae [4], as well as the association between certain *Campylobacter* virulence genes and the pattern of clinical infection confirm the importance of this zoonotic infection as a significant health hazard [5,6].

Campylobacter jejuni and *C. coli* colonize the gastrointestinal tracts of poultry, cattle, sheep, pigs and domesticated pets, such as dogs and cats. Most human enteric infections result from the ingestion of undercooked chicken [7]. Contaminated water or unpasteurized milk may also be sources for sporadic cases of disease or outbreaks of infection [8].

Campylobacter enteritis usually develops within 1 to 7 days after ingestion of a contaminated food, water or raw milk, with presenting symptoms of fever, abdominal pain, and mild to severe diarrhea. The disease is self-limited and does not usually require medical or therapeutic intervention except in severe cases. On rare occasions, serious post infection

sequels ranging from a transient reactive arthritis to Guillain-Barré syndrome [2], may develop due to the production of cross-reacting antibodies. Deaths from *Campylobacter* enteric infection are rare and occur primarily in infants, the elderly, or patients with underlying diseases [9].

The use of a selective medium is recommended for the optimal recovery of *Campylobacter* from stool samples [10]. Some of these selective media are Skirrow's medium [11], charcoal cefoperazone deoxycholate agar (CCDA) [12], and Campy-CVA medium [13]. Once inoculated, the medium is placed in a microaerophilic growth environment, incubated at 42°C for 72 h, and observed daily for the *Campylobacter* growth [12].

Direct detection of *Campylobacter* antigens in stool specimens by enzyme immunoassays (EIAs) has been developed such as the Premier CAMPY EIA (Meridian Bioscience, Cincinnati, OH), the ProSpecT *Campylobacter* EIA (Remel), and the ImmunoCard stat Campy test (Meridian Bioscience, Cincinnati, OH) [12].

Recently, DNA sequences of the *Campylobacter* genome were detected using real-time PCR, while the standard culture methods were

negative [14]. Also an in-house real-time PCR and a multiplex PCR named Seeplex Diarrhea ACE detection were studied by Bessède et al., [15] for detection of *Campylobacter* species, especially *Campylobacter jejuni* and *Campylobacter coli* in stool samples, as a major cause of human bacterial enteritis.

Aim of the work

This study aimed to compare *Campylobacter* spp. detection by molecular method (multiplex polymerase chain reaction) and by 2 immunoenzymatic methods (Premier CAMPY and ImmunoCard Stat Campy) to the culture method on Skirrow's medium.

2. Subjects and methods

This study was conducted on 350 patients (270 males and 80 females) with a mean \pm SD age of (58.5 \pm 4.5years) attending the Internal Medicine outpatient clinic, Ain Shams University Hospitals, Cairo, Egypt in the period from March 2011 to February 2012. Patients presented with symptoms of gastroenteritis in the form of diarrhea, colics, nausea and vomiting.

All patients were subjected to the following after their written consent:

- Full history taking and thorough clinical examination.
- Chest plain X-ray.
- Abdominal ultrasound.
- Collection of stool specimens:

Fecal specimens of the patients were subjected to microbiological examination, multiplex PCR, antigen ELISA and ImmunoCard Stat Campy.

Sample collection:

Stool specimens obtained from patients with gastrointestinal illness were sent to the laboratory for culture, antigen ELISA and ImmunoCard Stat Campy within 4 hrs. The remaining part of the stool samples was then frozen at -80°C for multiplex PCR.

I- Microbiological examination of fecal specimens [16]:

* Wet preparation by saline and eosin to exclude *Entamoeba histolytica*, *giardia lamblia* and other cysts or ova of parasites.

* Basic fuchsin smears for *cambylobacter*.

* Methylene blue preparation to detect pus cells.

* Gram stained film and motility to exclude vibrio.

* Culture on the following media:

a- MacConkey agar.

b- Xylose lysine deoxycholate agar to exclude *salmonella* and *shigella*.

c- Sorbitol MacConkey agar to exclude *E.coli* O157:H7 responsible for haemorrhagic colitis.

d- Alkaline peptone and thiosulphate citrate bile sucrose (TCBS) media to exclude *cholera*.

e- Culture on selective media for *Campylobacter* detection:

A stool sample was directly inoculated on Skirrow's medium (Oxoid, Basingstoke, Hampshire, United Kingdom) and incubated at 37°C and 42°C in a microaerobic atmosphere. Colonies were observed 24 hrs and 48 hrs after culture. Isolates that were oxidase positive and Gram-negative curved rods by Gram staining were identified as *Campylobacter* spp. [17]. Hippurate hydrolysis was used as a confirmatory test for the identification of *C. jejuni*.

Hippurate hydrolysis test:

Suspend a loopful of *Campylobacter* growth in 400 μl of a 1% Hippurate solution. Incubate at 37°C for 2 hours. Then slowly add 200 μl 3.5% ninhydrin solutions to the side of the tube to form an overlay. Reincubate at 37°C for 10 min, and read the reaction. Positive blue reaction indicating *Campylobacter jejuni*.

II- Antigen enzyme linked immunosorbent assay:

The Premier CAMPY (Meridian Bioscience, Inc., Cincinnati, OH) based on the use of specific monoclonal antibodies for a common antigen called *Campylobacter*-specific antigen (SA), that is shared by *C. jejuni* and *C. coli*. It can detect both species of *Campylobacter* in stool specimens but cannot differentiate them. Briefly: Fifty microliters of a well-mixed stool sample was transferred to the test tube containing 200 μl of sample diluent, and then the tube was vortexed for 15 s. One hundred microliters of the diluted stool sample was transferred to the microwell plate coated with specific monoclonal antibodies. After 60 min of incubation at room temperature, the microwell plate was washed with the washing buffer 5 times, and 2 drops of enzyme conjugate was added to each microwell and incubated for 30 min at room temperature. The microwell was washed 5 times before 2 drops of substrate was added and incubated for 10 min at room temperature. Then, 2 drops of stop solution was added, and the absorbance was read at 450 to 630 nm. Samples with an optical density greater than 0.1 were considered positive.

III- ImmunoCard Stat Campy:

ImmunoCard Stat Campy (Meridian Bioscience) is an immunochromatographic rapid test. A small solid stool sample was suspended in 1,400 μl of diluent, or 50 μl of liquid stools was added to 1,400 μl of the sample diluent, depending on the stool consistency. The diluted specimen was vortexed for 15 s, and then 175 μl was transferred to the sampling port of the device. After 20 min of incubation at room temperature, the result was read and validated if the control line band was clearly visible. A positive result showed 2 pink-red bands, the control band and a test line band, whereas a negative result showed only the pink-red control band.

IV - Multiplex polymerase chain reaction (PCR):***DNA extraction from stool.**

DNA from 180 mg stool specimens was extracted using a QIAamp DNA stool mini kit (Qiagen) according to the manufacturer's recommended procedures. The DNA obtained was stored at -20 °C.

***Multiplex PCR protocol.**

Three genes were targeted in the multiplex PCR protocol, namely *cadF* (genus-specific virulence gene), *hipO* (hippuricase gene for *C. jejuni*) and *asp* (aspartokinase gene for *C. coli*). The primer sets used, as described in table [1].

The multiplex protocol used a reaction mixture at a final volume of 50 µl, consisting of 25 µl multiplex master mix (Qiagen) contains HotStar *Taq* DNA polymerase, 0.5 µl *cadF* primer, 0.3 µl *asp* primer, 1.0 µl *hipO* primer, 0.5 µl 10 mg BSA ml⁻¹

(Promega), 4.5 µl eluted DNA and sterile water. The PCR amplification cycle included initial denaturation at 95 °C for 15 min, followed by 30 cycles of denaturation at 94 °C for 1 min, annealing at 49 °C for 1 min and extension at 72 °C for 1 min. The final stage was an extension cycle at 72 °C for 7 min. PCR cycles were carried out in a GeneAmp (Perkin-Elmer 9700; Applied BioSystems). *C. jejuni* ATCC 33291, *C. coli* strain, AGU 12305 were used as positive controls, and the negative control were included in every PCR run. Following gel electrophoresis, the amplified PCR product was stained with ethidium bromide and visualized with a UV transilluminator. The sizes of PCR products were estimated by comparison with 100 bp DNA molecular mass markers and the amplified control strains.

Table 1: The primer sets used in the multiplex PCR.

Primer	Sequence (5'-3')	Product (bp)
For <i>cadF</i> (forward)	TTG AAG GTA ATT TAG ATA TG	400
(reverse)	CTA ATA CCT AAA GTT GAA AC	
For <i>hipO</i> (forward)	GAA GAG GGT TTG GGT GGT G	735
(reverse)	AGC TAG CTT CGC ATA ATA ACT TG	
For <i>asp</i> (forward)	GGT ATG ATT TCT ACA AAG CGA G	500
(reverse)	ATA AAA GAC TAT CGT CGC GTG	

Nayak *et al.* (2005) [18]

Definition of a *Campylobacter*-positive stool sample:

The following criteria were used to define a stool sample positive for *Campylobacter*: either culture method was positive, or in the case of a negative culture, a positive molecular method and an immunoenzymatic method were both positive [15].

Results

Out of the 350 stool samples collected from patients with gastroenteritis, 23 specimens were positive (6.6%) based on the case definition, i.e., they were positive by culture method or, in case of a negative culture, by a positive molecular method and a positive immunoenzymatic method: 16 were positive by culture and 7 were culture negative but positive by both a molecular method (multiplex PCR) and an immunoenzymatic method. A total of 29 specimens were positive by at least one method. The different combinations are presented in table [2].

All methods were positive in only 14 cases. Of the positive culture specimens, 3 were missed, (one) by the ELISA and (two) by ImmunoCard.

In 6 out of 7 samples that fulfilled the positivity criteria when culture was negative, all of the methods were positive.

Of the 6 cases that were positive by immunoenzymatic methods only, 4 samples were positive by 2 immunoenzymatic methods and 2 samples were positive by ELISA only.

The *Campylobacter* species identified by culture were 10 (62.5%) *C. jejuni*, 6 (37.5%) *C. coli*, while multiplex (PCR) revealed 13 (56.5%) *C. jejuni*, 8 (34.8%) *C. coli* and 2 (8.7%) specimens had mixed infection (*C. jejuni* and *C. coli*). The *Campylobacter* species identified by culture and multiplex PCR were shown in table [3]. The immunoenzymatic test did not allow differentiation between *C. jejuni* and *C. coli*.

Out of the 350 stool specimens 15 (4.8%) specimens were reported as *Salmonella enterica* serovar *Typhi* positive and 7 (2%) were *Shigella sonii* positive.

Diagnostic validity test including sensitivity, specificity, predictive values of multiplex (PCR), Premier CAMPY ELISA and ImmunoCard Stat Campy were shown in tables [3, 4, 5]. The sensitivity of the multiplex PCR was higher than the ELISA and

ImmunoCard Stat Campy tests (100%, 95.6% and 86.9% respectively) while the ImmunoCard Stat Campy had higher specificity than the ELISA and

multiplex PCR (98.7%, 98.1% and 97.9% respectively).

Table 2: Distribution of the positivity profiles of the cases using different techniques for detection of *Campylobacter* spp.

	Culture	Multiplex PCR	Premier CAMPY ELISA	ImmunoCard Stat Campy
Positive by culture (n = 16)				
14	+	+	+	+
1	+	+	+	-
1	+	+	-	-
Positive by other tests (n = 7)				
6	-	+	+	+
1	-	+	+	-
Positive by Ag tests only (n = 6)				
4	-	-	+	+
2	-	-	+	-

Table 3: The *Campylobacter* species identified by culture on Skirrows and multiplex PCR.

	<i>C. jejuni</i> No. (%)	<i>C. coli</i> No. (%)	Mixed <i>C. jejuni</i> and <i>C. coli</i> No. (%)	Total
Culture	10 (62.5%)	6 (37.5%)	-	16
Multiplex (PCR)	13 (56.5%)	8 (34.8%)	2 (8.7%)	23

Table 4: Diagnostic validity test of multiplex (PCR) using culture as the reference method.

	True positive	False positive	True negative	False negative
Multiplex (PCR)	16	7	327	0
	Sensitivity %	Specificity %	Positive predictive %	Negative predictive %
	100	97.9	69.6	100

Table 5: Diagnostic validity test of Premier CAMPY ELISA using multiplex (PCR) as the reference method.

	True positive	False positive	True negative	False negative
Premier CAMPY ELISA	22	6	321	1
	Sensitivity	Specificity	Positive predictive value	Negative predictive value
	95.6%	98.1%	78.5%	99.7%

Table 6: Diagnostic validity test of ImmunoCard Stat Campy using multiplex (PCR) as the reference method.

	True positive	False positive	True negative	False negative
Immuno Card Stat Campy	20	4	323	3
	Sensitivity	Specificity	Positive predictive value	Negative predictive value
	86.9%	98.7%	83.3%	99.1%

1- Discussion

Campylobacter species, especially *Campylobacter jejuni* and *Campylobacter coli*, are a major cause of human bacterial enteritis. Current detection in stools is done essentially by culture on selective and nonselective media with filtration [14].

In our multiplex (PCR) protocol, three genes, namely *cadF* (genus-specific virulence gene), and *hipO* and *asp* (species specific for *C. jejuni* and *C. coli*, respectively), were targeted. The *cadF* gene, a

virulence gene associated with adhesion, is 100 % conserved among isolates of diverse sources [19,12]. The *hipO* gene is highly conserved in *C. jejuni* strains and represents the most widely validated gene for the identification of *C. jejuni* [20,7]. The *asp* gene encodes aspartokinase and is highly specific for *C. coli* [21].

Our results revealed that out of the 350 stool samples collected from patients with gastroenteritis, 23 specimens were positive (6.6%) based on the case

definition: 16 were positive by culture and 7 were culture negative but positive by both a molecular method (multiplex PCR) and an immunoenzymatic method. All methods were positive in 14 cases. The *Campylobacter* species identified by culture were 10 (62.5%) *C. jejuni*, 6 (37.5%) *C. coli*, while multiplex (PCR) revealed 13 (56.5%) *C. jejuni*, 8 (34.8%) *C. coli* and 2 (8.7%) specimens had mixed infection (*C. jejuni* and *C. coli*). Al Amri et al., [4] reported that of the 114 stool specimens (54 human and 60 chicken) evaluated by the multiplex PCR protocol, 70 (61.4 %) were identified as *C. jejuni*, 35 (30.7%) as *C. coli* and 9 (7.9 %) as a mixed infection with both species. Among the stool specimens that were culture negative for *Campylobacter*, two (6.7 %) were *C. jejuni* positive. The ability of the multiplex PCR to detect such mixed infections has important therapeutic implications in view of the high level of resistance of *C. coli* to erythromycin, which is usually the drug of choice for *C. jejuni*. Bessède et al., [15] reported that out of 242 stool specimens tested by 2 molecular methods, an in-house real-time PCR and a multiplex PCR named Seeplex Diarrhea ACE Detection, and 3 immunoenzymatic methods, Premier CAMPY, RidaScreen *Campylobacter*, and ImmunoCard Stat Campy, 23 (9.5%) fulfilled the positivity criteria: 16 were positive by culture and 7 were culture negative but positive by one molecular method and immunoenzymatic method. All methods were positive in only 7 cases. This could be explained by long contact of the bacteria with a normal atmosphere during stool processing, and the antibiotics incorporated into the selective media may inhibit certain *Campylobacter* strains.

Our study revealed that all culture-positive specimens were identified by multiplex PCR. In addition, 334 specimens identified as *Campylobacter* culture negative were examined and 7 (2%) were found to be *Campylobacter* positive by the multiplex PCR. Six of them were positive by all methods (multiplex PCR Premier CAMPY ELISA and ImmunoCard Stat Campy). O'Leary et al., [22] had studied 773 stool samples by routine culture and the EntericBio system (a multiplex PCR assay). He found that 42 samples had *Campylobacter* positive results by culture, and all of these were positive with the EntericBio system. This system detected an additional 12 positive samples *Campylobacter* spp.

Al Amri et al., [4] reported that a total of 61 specimens were identified as *Campylobacter* culture positive and the remaining 30 were *Campylobacter* negative, all culture-positive specimens were identified by multiplex PCR protocol. In addition, 30 human specimens identified as *Campylobacter* negative were examined and 7 (6.7 %) were found to be *Campylobacter* positive by the multiplex protocol.

These findings are indicative of the usefulness of this protocol to correctly detect the presence of *Campylobacter* spp. in stools.

In our study the sensitivity of the multiplex PCR was higher than the ELISA and ImmunoCard Stat Campy tests (100%, 95.6% and 86.9% respectively) while the ImmunoCard Stat Campy had higher specificity than the Premier CAMPY ELISA and multiplex PCR (98.7%, 98.1% and 97.9 % respectively). Bessède et al., [15] had reported that the specificities and negative predictive values (NPV) of the different methods were all in the range of 95 to 100% while the sensitivity of ELISA was higher than ImmunoCard Stat Campy and multiplex PCR it was (96%, 92% and 88.7% respectively) **conclusion:** multiplex PCR is attractive as it enables the detection and speciation of *Campylobacter*. Also the procedure of the multiplex PCR had a turnaround time of 6 h. The Premier CAMPY ELISA was rapid and had acceptable performance sensitivity of 95.6%.

Corresponding author:

Mona Zaki Zaghoul,
Consultant of Clinical Pathology, Microbiology unit,
Department of Clinical Pathology,
Faculty of Medicine, Ain Shams University.
monazaki_810@hotmail.com

References

1. Moore, J. E., Corcoran, D., Dooley, J. S., Fanning, S., Lucey, B., Matsuda, M., McDowell, D. A., Mégraud, F., Miller, B. C. & other authors (2005): *Campylobacter*. Vet Res, 36: 351-382.
2. Islam, Z., Gilbert, M., Mohammad, Q.D., Klaij, K., Li, J, et al, (2012) Aug 27. :Guillain-Barré Syndrome-Related *Campylobacter jejuni* in Bangladesh: Ganglioside Mimicry and Cross-Reactive Antibodies. PLoS One .7(8):e43976.
3. Gillis D., Cronquist A., Cartter M., Tobind'Angelo M., Blythe D., Smith K., Lathrop S., Cieslak P., Dunn J., Holt K. G., Guzewich J. J., Henao O. L., Mahon B., Griffin P., Tauxe R. V., Crim S. M. (2011). Vital signs: incidence and trends of infection with pathogens transmitted commonly through food – foodborne diseases active surveillance network, 10 U.S. sites, 1996-2010. MMWR Morb. Mortal. Wkly. Rep. 60, 749754.
4. Al Amri, A., Senok, A.C., Ismael, A.Y., Al-Mahmeed, A.E., Botta, G.A.(2007) Oct: Multiplex PCR for direct identification of *Campylobacter* spp. in human and chicken stools. *J Med Microbiol* ,56(Pt 10):1350-5.
5. Al-Mahmeed, A., Senok, A. C., Ismael, A.Y., Bindayna, K. M., Tabbara, K. S., Botta, G. A.

- (2006): Clinical relevance of virulence genes in *Campylobacter jejuni* isolates in Bahrain. *J Med Microbiol*, 55: 839-843.
6. Rozynek, E., Dzierzanowska-Fangrat, K., Jozwiak, P., Popowski, J., Korsak, D., Dzierzanowska, D. (2005): Prevalence of potential virulence markers in Polish *Campylobacter jejuni* and *Campylobacter coli* isolates obtained from hospitalized children and from chicken carcasses. *J Med Microbiol*, 54: 615-619.
 7. Stern, N. J., and J. E. Line. (1992): Comparison of three methods for recovery of *Campylobacter* spp. from broiler carcasses. *J. Food Prot*, 55:663-666.
 8. Infectious Disease Epidemiology Section, Office of Public Health, Louisiana Department of Health and Hospitals. Revision date, 25 February (2008). *Campylobacteriosis*
 9. Blaser, M., and B. M. Allos. (2005): *Campylobacter jejuni* and related species, p. 2548-2557. In G. Mandell, J. E. Bennet, and R. Dolin (ed.), *Principles and practice of infectious disease*, 6th ed. Elsevier/Churchill Livingstone, New York, NY.
 10. Fitzgerald, C., and I. Nachamkin. (2007): *Campylobacter* and *Arcobacter*, p. 933-946. In P. R. Murray, E. J. Baron, J. H. Jorgensen, M.
 11. Sinha, S., Prasad, K. N., Pradhan, S., Jain, D., Jha, S. (2004): Detection of preceding *Campylobacter jejuni* infection by polymerase chain reaction in patients with Guillain-Barre syndrome. *Trans R Soc Trop Med Hyg*, 98: 342-346.
 12. Granato, P.A., Chen, L., Holiday, I., Rawling, R.A., Novak-Weekley, S.M., Quinlan, T., Musser, K.A. (2010) Nov: Comparison of premier CAMPY enzyme immunoassay (EIA), ProSpecT *Campylobacter* EIA, and ImmunoCard STAT CAMPY tests with culture for laboratory diagnosis of *Campylobacter* enteric infections. *J Clin Microbiol*, 48(11):4022-7.
 13. Reller, L. B., S. Mirrett, and L. G. Reimer. (1983). Abstr. 85th Annu. Meet. Am Soc Microbiol, C-274: 357.
 14. Nakamura, S., Maeda, N., Miron. I.M, Yoh, M., Izutsu, K, et al, (2008): Metagenomic diagnosis of bacterial infections. *Emerg Infect Dis*, 14:1784-1786.
 15. Bessède, E., Delcamp, A., Sifré, E., Buissonnière, A., Mégraud, F. (2011) Mar: New methods for detection of campylobacters in stool samples in comparison to culture. *J Clin Microbio*, 49(3):941-4.
 16. Cheesbrough, M. *District laboratory practice in tropical countries*, Cambridge University press, (2000), part 2, page 104.
 17. Hutchinson, D. N., and F. J. Bolton. (1984): Improved blood free selective medium for the isolation of *Campylobacter jejuni* from faecal specimens. *J Clin Pathol*, 37:956-957.
 18. Nayak, R., Stewart, T. M., Nawaz, M. S. (2005): PCR identification of *Campylobacter coli* and *Campylobacter jejuni* by partial sequencing of virulence genes. *Mol Cell Probes*, 19: 187-193.
 19. Datta, S., Niwa, H., Itoh, K. (2003): Prevalence of 11 pathogenic genes of *Campylobacter jejuni* by PCR in strains isolated from humans, poultry meat and broiler and bovine faeces. *J Med Microbiol*, 52: 345-348.
 20. Skirrow, M. B. (1977): *Campylobacter* enteritis: a "new" disease. *Br Med J*, ii: 9-11.
 21. Linton, D., Lawson, A. J., Owen, R. J., Stanley, J. (1997): PCR detection, identification to species level, and fingerprinting of *Campylobacter jejuni* and *Campylobacter coli* direct from diarrheic samples. *J Clin Microbiol*, 35: 2568-2572.
 22. O'Leary, J., Corcoran, D and Lucey, B. (2009) Nov: Comparison of the EntericBio multiplex PCR system with routine culture for detection of bacterial enteric pathogens. *J Clin Microbiol*, 47(11):3449-53.

10/12/2012

Virulence of two Entomopathogenic nematodes (*Heterorhabditis bacteriophora*, *Heterorhabditis zealandica*) to *Galleria mellonella* (Lepidoptera: Pyralidae), *Tenebrio Molitor* (Coleoptera: Tenebrionidae) and pupae in the laboratory

Lubanza Ngoma^{1*}, Mirabel Akwa Nyamboli², Vince Gray³, Olubukola Oluranti Babalola¹

¹ Department of Biological Sciences, Faculty of Agriculture, Science and Technology, North-West University, Mafikeng Campus, Private Bag X2046, Mmabatho 2735, South Africa.

² Council for Scientific and Industrial Research (CSIR) P.O. Box 395, Pretoria 0001, South Africa

³ School of Molecular and Cell Biology, University of the Witwatersrand, Private Bag 3, Wits 2050, South Africa. jclubanza@yahoo.co.uk or jclubanza@hotmail.com

Abstract: *Heterorhabditis zealandica* (JF416797) and *Heterorhabditis bacteriophora* (JF416798) were evaluated for their virulence and reproductive potential using *Galleria mellonella*, *Tenebrio molitor* larvae and *Tenebrio molitor* pupae. Data obtained 24 hours post *Heterorhabditis bacteriophora* and *Heterorhabditis zealandica* application showed no significant differences in mortality ($P = 0.1379$) for all insect hosts. At 48 hours, insect mortality was highest at all dosages for *Heterorhabditis zealandica* ($P = 0.7846$) and *Heterorhabditis bacteriophora* ($P = 0.7975$). No significant differences were noted at 72 hours (*Heterorhabditis zealandica*: $P = 0.1555$; *Heterorhabditis bacteriophora* $P = 0.2444$) and 96 hours *Heterorhabditis zealandica*: $P = 0.0850$; *Heterorhabditis bacteriophora*: $P = 0.4662$). The reproductive test showed that *Galleria mellonella* produced the highest number of *Heterorhabditis zealandica*: 220500 ± 133933 infective juveniles, followed by *Tenebrio molitor*: 152133 ± 45466 infective juveniles and the lowest was pupae: 103366 ± 56933 infective juveniles. For *Heterorhabditis bacteriophora*, the highest number was observed in *Tenebrio molitor* exposed to 500 infective juveniles: 197666.6 infective juveniles/cadaver and *Galleria mellonella* exposed to 10 *Heterorhabditis bacteriophora*: 147933.333 infective juveniles/cadaver. The least number of progeny was produced by pupae: 13533.33 infective juveniles. The conclusion is that both nematodes have killed insects (particularly *Heterorhabditis zealandica*), and field testing is warranted.

[Ngoma L, Nyamboli MA, Gray VM, Babalola OO. **Virulence of two Entomopathogenic nematodes (*Heterorhabditis bacteriophora*, *Heterorhabditis zealandica*) to *Galleria mellonella* (Lepidoptera: Pyralidae), *Tenebrio Molitor* (Coleoptera: Tenebrionidae) and pupae in the laboratory.** *Life Sci J* 2012;9(4):2572-2579] (ISSN:1097-8135). <http://www.lifesciencesite.com>. 382

Keywords: *Galleria mellonella* larvae; *Tenebrio molitor* larvae; pupae; *Heterorhabditis zealandica*; *Heterorhabditis bacteriophora*; virulence; biological control.

1. Introduction

Entomopathogenic nematodes (EPNs) of the genus *Steinernema* live in a close symbiotic association with bacteria of the genus *Xenorhabdus* spp. while *Heterorhabditis* are associated with bacteria of the genus *Photorhabdus* spp (Shapiro-Ilan et al., 2012). These EPNs have attracted a lot of research in the agro-forestry industry as excellent candidate and safe biological control agents for a variety of insect pests in several ornamental and crop production systems (Ehlers, 2007). The life cycle of EPNs (*Steinernema* spp and *Heterorhabditis* spp) begins in the soil (Spence et al., 2011). Infective juveniles (IJs) is the only stage of nematode capable of surviving outside of a host (in the soil) and functions as the vector for the bacterial pathogens that kill the insect hosts. It is also a non-feeding, non-developing stage (Salame et al., 2010). The IJs actively seek out and penetrate potential insect larval hosts through natural openings such as the mouth, anus, spiracles or cuticle (for some species of EPNs).

After entering the insect hemolymph, nematodes release their symbiotic bacteria which multiply and secrete a wide range of extracellular hydrolytic enzymes that serve to assist the nematode in overcoming host immune system. Usually death occurs within 24 to 48 hrs (Shapiro-Ilan et al., 2012). The IJs feed on the rapidly multiplying bacterial cells, degrade host tissues and mature into adults, often completing 1-3 generations within the host cadaver. When food reserves are depleted, EPNs reproduction ceases and the offspring develop into resistant IJs that disperse from the cadaver to search for new hosts (Koppenhöfer et al., 2007).

The success of EPNs applications for insect pest control in agriculture soil depends on the IJ's aptitude to move and survive until it can locate an insect host (Koppenhöfer and Fuzy, 2007). It has been shown that factors such as behavioural, physiological, temperature, soil moisture, soil texture and ultra violet radiation affect IJ dispersal and persistence (Koppenhöfer and Fuzy, 2007).

EPNs have been found widely distributed under diverse ecological conditions and throughout North and South America, Australia, Europe, Asia and Africa (Salame et al., 2010). The African continent represents a fertile field for EPN exploration. In the few surveys which have been conducted, a number of new species and strains have been reported (Kaya et al., 2006). EPN species have been described in Cameroon (Kanga et al., 2012) Egypt (Abdel-moniem and Gesraha, 2001); Kenya (Stack et al., 2000), Tanzania (Mwaitulo et al., 2011) and South Africa (Malan et al., 2006; 2008). Current research on the fauna of Africa has focused on their efficacy under laboratory and field conditions (Kaya et al., 2006). Substantial efforts have been made in EPN research to isolate, identify and test a range of native EPNs against economically important insect pests.

Applying exotic EPNs will affect negatively native communities and ecosystem services provided by soil biodiversity (Campos-Herrera et al., 2011). Millar and Barbercheck (2001) found that when the exotic *Steinernema riobrave* was applied, detection of the endemic *Heterorhabditis bacteriophora* decreased, with possible effects on long term pest suppression. In this respect, the isolation of native species of EPNs provides a valuable source, not only from a biodiversity perspective but also from a more applicable standpoint (Stock et al., 2003).

The first objective of this study was therefore to determine and compare the virulence of two local Heterorhabditid nematodes: *Heterorhabditis bacteriophora* (Poinar, 1976) and *Heterorhabditis zelandica* (Poinar, 1990) to three insect hosts: *Galleria mellonella*, *Tenebrio Molitor* larvae and pupae of *Tenebrio molitor* larvae using one type of laboratory bioassay, namely, the dose-response assay. The virulence was evaluated on the basis of their ability to infect and kill the insect hosts. The second objective was to determine the reproduction capability of EPNs in *G. mellonella*, *T. molitor* larvae and pupae of *T. molitor* larvae.

2. Materials and methods

2.1 Nematodes Inoculum

The nematode isolates used in this study were *H. Zealandica* JF416797 and *H. bacteriophora* JF416798. These two species were found during local surveys conducted at the Agricultural Research Council (ARC) Roodeplaat experimental farm and Brits (South Africa). Both species were identified by polymerase chain reaction (PCR) and restriction fragment length polymorphism (RFLP), which are molecular identification methods. Nematodes were cultured on last instars *G. mellonella* and *T. molitor* larvae according to the method of Kaya and Stock (1997) at 25°C. IJs were recovered using White traps

as described by Kaya and Stock (1997) and the newly emerging IJs were suspended and acclimatized for at least 6 hours (hrs) at ambient room temperature before application.

2.2 Insect selection

Last-instar wax moth larvae (Lepidoptera: Pyralidae), were obtained from an existing laboratory culture that was kept in the dark, aerated in 3L volume Consol® glass jars (11 cm diameter and 15 cm height) at 25-28°C on an artificial medium (honey, cereal and yeast extract) at the University of the Witwatersrand South Africa according to the method described by Woodring and Kaya (1988). Insect host *T. molitor*, more commonly known as the mealworm (Coleoptera: Tenebrionidae), is the larval form of a species of darkling beetles and was obtained from a pet shop in Kensington (South Africa). Only healthy larvae were selected for testing in the multi-well plastic tissue culture trays so as to exclude the effects of a stressor.

2.3 Dose-response assays

Thirty-two well plastic tissue culture trays (BD Falcon TM) of 5 cm in diameter and 3 cm in depth diameter were used as the experimental arena. Each wells were filled with 2 g of autoclaved (121°C-3hrs) air-dried river sandy loam (particle size variable between 150-354 µm, 70% sand, 17% silt, 10% clay, and 3% organic matter, pH 6) adjusted to 10% w/w water content. The moisture content was kept stable by high room humidity to avoid rapid evaporation. Individual *G. mellonella* larvae and *T. molitor* larvae and pupae were exposed to 5, 10, 25, 50, 100, 200, 400 and 500 IJs of *H. bacteriophora* and *H. zelandica* applied in 1 ml of tap water to the centre of each well; where every five wells were considered as one observation. Control wells received water only, but were exposed to identical environmental conditions. The plates were then incubated at room temperature (28±3°C) in the dark. Four replicates were made for each nematode concentration and the bioassay experiment was repeated three times in parallel. Insect mortality was monitored every 24 hrs over a period of 4 days following exposure of the IJs. The mortality was determined by poking still insects; if no movement was noted, the insects were considered dead. Moreover, straight insects and insects which were already showing colour change as is evident in EPN-infected insects were considered dead as well.

2.4 Estimating final nematode yield

Counting large numbers of nematodes was impractical; hence the following serial dilution method described by Glazer and Lewis (2000) was commonly used during the course of this study: (a) the nematode suspensions were properly shaken in the 50 ml tissue culture tubes. A 50 µl aliquot was

withdrawn with a micropipette and transferred to a 5-cm Petri dish. Three samples were collected from each suspension, placed into 3 different Petri dishes and 15 ml of water were added to each Petri dish. (b) The nematodes in the dishes were counted under a dissecting microscope. Final nematode concentration per ml was calculated by multiplying the average of the three 50 μ l counts by 20.

2.5 Statistical analysis

The STATA SE 9, (Statacorp) was used to analyse all data. Virulence data as well as data on the mean number of progeny IJs emerging per cadaver were analyzed using one-way ANOVA. The assumption of equal variances was checked using Bartlett's test before ANOVA. Mortality data expressed as percentages were transformed by Arcsin transformations before statistical analysis. Means for percentage mortality were separated using the post ANOVA Bonferroni's multiple comparison test. The reference probability used throughout was $P \leq 0.05$.

3. Results

3.1 Dose-response assay

The control data were not included in the analyses of data in this study because no mortality of unexposed larvae occurred in any experiment. In the first experiment, the virulence of *H. bacteriophora* and *H. zealandica* were evaluated on the basis of their ability to infect and kill the insects at different doses. Figures 1-2-3-4-5-6 below show the mortality trend caused by *H. bacteriophora* and *H. zealandica* respectively in *G. mellonella* larvae as well as *T. molitor* larvae and pupae, at 24, 48, 72 and 96 hrs. Even as early as 24 hrs after exposure to IJs, a gradual increase in mortality was observed from dose 100 up to 500 IJs (Figs 1-2-3-4-5-6). Data analysis obtained 24 hrs post exposure to IJs of *H. bacteriophora* and *H. Zealandica* showed no significant differences in mortality between larvae exposed to different *H. bacteriophora* IJ doses (*H. bacteriophora*: $F = 2.15$; $df = 2$; $P = 0.1379$) for *G. mellonella* larvae as well as *T. molitor* larvae and pupae (Figs 1-2-3). However there were significant differences in mortality between larvae exposed to different IJ doses of *H. zealandica* (*H. zealandica*: $F = 7.28$; $df = 2$; $P = 0.0034$) for *G. mellonella* larvae as well as *T. molitor* larvae and pupae (Figs 4-5-6). After 48 hrs, insect mortality was highest at all dosages for both *H. bacteriophora* and *H. zealandica*. The trend in mortality was more consistent for insect larvae that were exposed to 100-500 IJs of *H. bacteriophora* or *H. zealandica*. Furthermore, it seems that larvae exposed to IJs of *H. zealandica* experienced higher levels of mortality compared to those exposed to *H. bacteriophora*. Less than 10% of the larvae were killed when exposed to 100 IJs of *H. bacteriophora* but mortality levels for larvae were

generally higher than 15% for *H. zealandica* (Figs 4-6). Insects *T. molitor* larvae and pupae were far more susceptible to the *H. zealandica* than to *H. bacteriophora*. Mortality was particularly high among pupae exposed to the *H. zealandica* with 20% dying after 24 hrs of exposure. At IJ concentrations of 5-50 IJs /larvae, there was a similar trend in mortality for all larvae exposed to either *H. bacteriophora* or *H. zealandica*. However, mortality was higher at smaller doses (5 and 10 IJs/ *G. mellonella* and *T. molitor* larvae) exposed to *H. Zealandica* compared to those exposed to *H. bacteriophora*. The following results were obtained after 48 hrs post exposure (Figs 1-3 and Figs 4-6): (*H. bacteriophora*: $F = 0.23$; $df = 2$; $P = 0.7975$ | *H. zealandica*: $F = 0.25$; $df = 2$; $P = 0.7846$). Bonferroni's test post ANOVA showed differences in *H. bacteriophora* only between 25-500 IJs/insect when compared to 5 and 10. High mortality of *H. zealandica* was observed between doses of 50 and 500 when compared to 5, 10 and 50 IJs/insect. The mortality was significantly influenced by nematode densities (Figs 1-2-3-4-5-6). Pupae of *T. molitor* were found to be susceptible to all isolates of the two nematode species, with cumulative mortalities ranging between 20% and 90% (Figs. 2-5). Data obtained at 72 hrs post exposure to varying nematode doses (Figs 1-3 and Figs 4-6), showed no significant differences in mortality by dose of the nematode species: *H. bacteriophora*: $F = 1.49$; $df = 2$; $P = 0.2444$ | *H. zealandica*: $F = 6.50$; $df = 2$; $P = 0.1555$); thus a post ANOVA multiple comparison test was not performed. The same was true for data obtained at 96 hrs post exposure: (*H. bacteriophora*: $F = 0.79$; $df = 2$; $P = 0.4662$ | *H. zealandica*: $F = 2.74$; $df = 2$; $P = 0.0850$). No mortalities were observed in nematode control treatments.

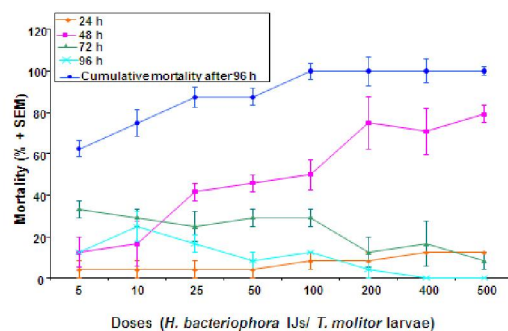

Figure 1: The percentage mortality of *T. molitor* larvae, following exposure to different concentrations (5, 10, 25, 50, 100, 200, 400, and 500) of IJs of *H. bacteriophora* in the dose response assay for 24, 48, 72 and 96 hrs of exposure. Bars represent \pm standard error of the mean.

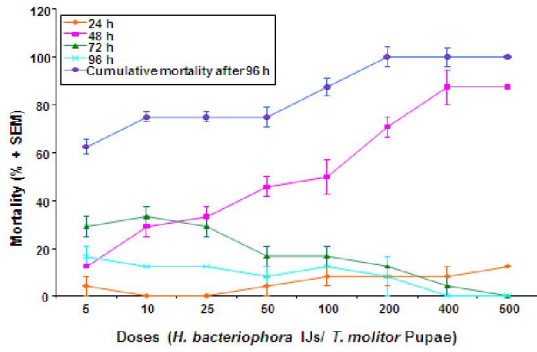

Figure 2: The percentage mortality of pupae, following exposure to different concentrations (5, 10, 25, 50, 100, 200, 400, and 500) of IJs of *H. bacteriophora* in the dose response assay for 24, 48, 72 and 96 hrs of exposure. Bars represent \pm standard error of the mean.

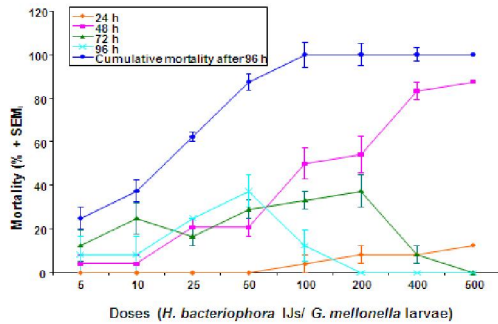

Figure 3: The percentage mortality of *G. mellonella* larvae, following exposure to different concentrations (5, 10, 25, 50, 100, 200, 400, and 500) of IJs of *H. bacteriophora* in the dose response assay for 24, 48, 72 and 96 hrs. Bars represent \pm standard error of the mean.

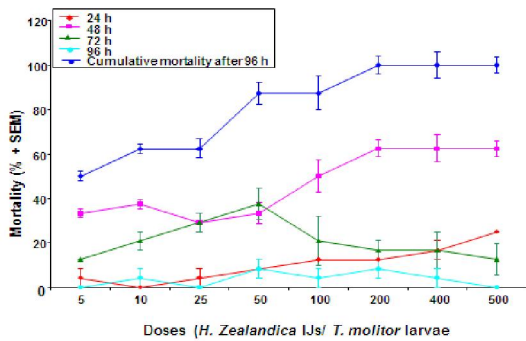

Figure 4: The percentage mortality of *T. molitor* larvae, following exposure to different concentrations (5, 10, 25, 50, 100, 200, 400, and 500) of IJs of *H. zealandica* in the dose response assay for 24, 48, 72 and 96 hrs of exposure. Bars represent \pm standard error of the mean.

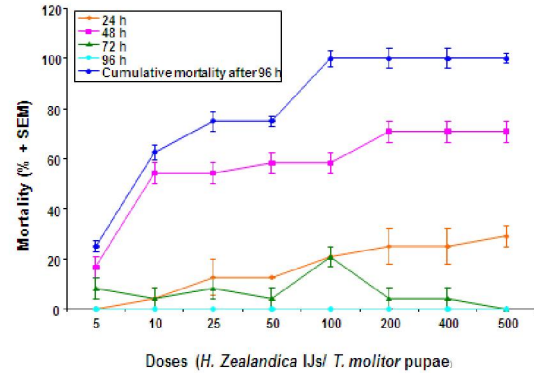

Figure 5: Percentage mortality of pupae, following exposure to different concentrations (5, 10, 25, 50, 100, 200, 400, and 500) of IJs of *H. zealandica* in the dose response assay for 24, 48, 72 and 96 hrs of exposure. Bars represent \pm standard error of the mean.

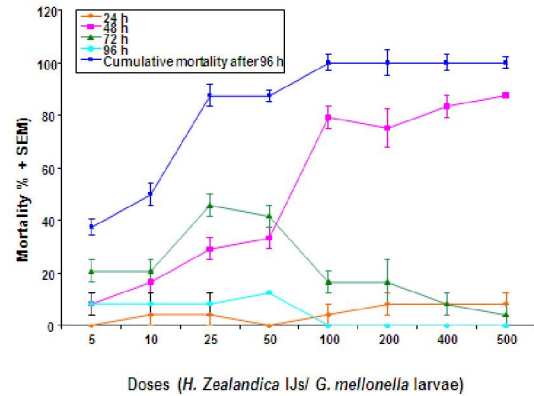

Figure 6: The percentage mortality of *G. mellonella* larvae, following exposure to different concentrations (5, 10, 25, 50, 100, 200, 400, and 500) of IJs of *H. zealandica* in the dose response assay for 24, 48, 72 and 96 hrs of. Bars represent \pm standard error of the mean.

3.2 Reproduction Assays

The IJ progeny production differed among the three larvae hosts used and the IJ doses exposed to, as well as the EPN species (Figs 7-8). The highest number of emerged IJs of *H. zealandica* was produced by *G. mellonella* (mean \pm SEM: 220500 \pm 133933 IJs), followed by *T. molitor* larvae (mean \pm SEM: 152133 \pm 45466 IJs) and the lowest was *T. molitor* pupae (mean \pm SEM: 103366 \pm 56933 IJs). In the case of *T. molitor*, more progeny IJs were produced by pupae which had been exposed to lower doses of *H. zealandica* IJs (<50 IJs/ pupae), but the IJ production was reduced in pupae that had been exposed to higher doses of *H. zealandica* IJs (Fig 7).

The afore-described trend for pupae is the reverse in the larvae (Fig 7). For *H. bacteriophora*-infected cadavers, the highest number of emerged IJs was observed in *T. molitor* larvae which had been exposed to 500 IJs, producing an average of 197666.6 IJs/ cadaver. Additionally, *G. mellonella* insects which had been individually exposed to 10 *H. bacteriophora* IJs produced on average 147933.333 IJs/ cadaver. The least number of progeny IJs was produced by *T. Molitor* pupae (13533.33 IJs). IJ production is reduced in *G. mellonella* exposed to higher IJ doses of *H. bacteriophora*, while the numbers produced by *T. molitor* larvae seem to increase as the IJ dose increases (Fig 8).

Data obtained revealed no significant differences in the number of emerged IJs among *H. bacteriophora* and *H. zealandica* in the three larvae hosts (*H. bacteriophora*: $F = 0.22$; $df = 7$; $P = 0.9799$ | *H. zealandica*: $F = 0.54$, $df = 7$, $P = 0.8024$). Moreover, there were no significant differences between the number of emerged IJs between *H. bacteriophora* nematode and *H. zealandica* nematode at all doses: [(5 IJs/larvae: $F = 0.2924$; $df = 16$; $P = 0.3869$); (10 IJs/larvae: $F = 0.2654$; $df = 16$; $P = 0.6029$); (25 IJs/larvae: $F = 0.1154$; $df = 16$; $P = 0.4588$); (50 IJs/larvae: $F = 0.0905$; $df = 16$; $P = 0.4645$); (100 IJs/larvae: $F = 0.8862$; $df = 16$; $P = 0.1943$); (200 IJs/larvae: $F = 0.5431$; $df = 16$; $P = 0.2973$); (400 IJs/larvae: $F = 0.4776$; $df = 16$; $P = 0.3197$); (500 IJs/larvae: $F = 0.2205$; $df = 16$; $P = 0.4141$)].

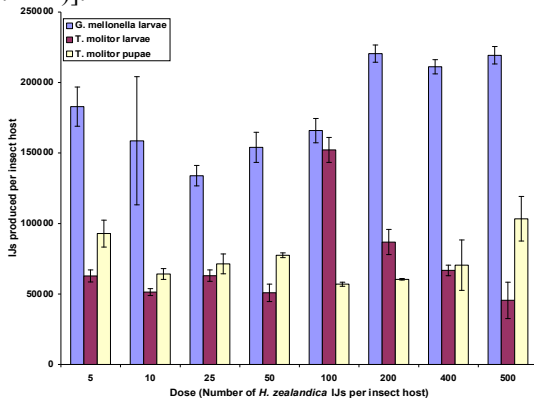

Figure 7: Mean number of progeny IJs which emerged from *G. mellonella*, *T. molitor* larvae and pupae that were exposed to different doses of *H. zealandica* nematodes. Bars are \pm standard error of the mean.

4. Discussions

The results obtained in this study clearly showed that the pathogenicity of these two EPN species tested to insect hosts and virulence varied considerably, thus suggesting that each complex presents different virulence degrees (Figs 1-2-3-4-5-

6). This is profusely documented in literature (Rosa et al., 2000). Both high and low nematode inoculums were effective in causing insect mortality but the results varied considerably among nematodes within insect hosts. However, infectivity differed between host for *H. bacteriophora* and *H. zealandica*. At 24 hrs, *H. zealandica* showed a relatively higher virulence than *H. bacteriophora* as it caused 20% mortality to *G. mellonella* and *T. molitor* larvae, while *H. bacteriophora* induced less than 5% mortality in pupae. This observation may be explained using four approaches. The first approach postulates that the use of different hosts for rearing may have affected the relative virulence of *H. bacteriophora* (Koppenhöfer et al., 2007). According to the second approach, the speed of releasing into the haemolymph of the symbiotic bacteria to overcome the immune system of the insect host might have been higher in *H. zealandica* than in *H. bacteriophora*. The third approach suggests that *H. zealandica* might have grown and reproduced faster than *H. bacteriophora* in the insect haemolymph (Aydin and Susurluk, 2005). The fourth approach could be explained by differences in the ability of the EPNs to penetrate the insect host.

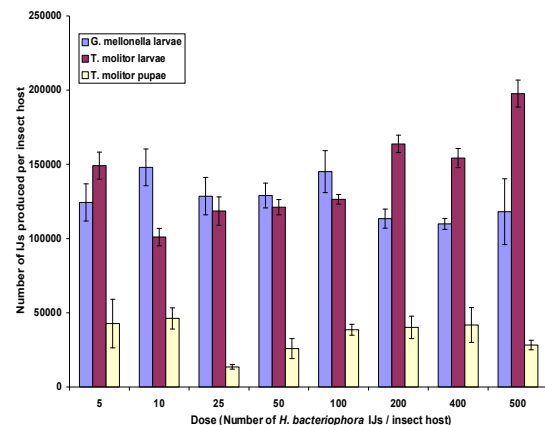

Figure 8: Mean number of progeny IJs which emerged from *G. mellonella*, *T. molitor* larvae and pupae that were exposed to different doses of *H. bacteriophora* nematodes. Bars are \pm standard error of the mean.

Results obtained at 48 hrs, showed that both nematodes killed great numbers of larvae hosts when exposed to IJ doses even as low as 50 IJs/larvae. Overall, mortality increased with longer exposure times (Figs 1-2-3 and Figs 4-5-6). The highest mortality was observed in *G. mellonella* larvae at all exposure times followed by pupae (Figs 1-2 and Figs 4-5). These findings suggest that longer exposure times make it possible for more nematodes to penetrate their insect hosts. Therefore, more

symbiotic bacteria are released by the nematodes which kill the insects by septicaemia (Wang et al., 1995). *G. mellonella* larvae have a softer cuticle, more spiracles and a larger surface area than *T. molitor*. These features allowed nematodes to penetrate *G. mellonella* more easily; hence this group experienced the highest mortality of all insect types tested. Another factor is carbon dioxide (CO₂) which has been reported to be an important attractive factor for EPNs (O'Hallaran and Burnell, 2003). Variation in CO₂ production over time among different insect species was correlated with insect host finding by EPNs (Koppenhöfer and Fuzy, 2008). In terms of production, it has been shown that *G. mellonella* produced more CO₂ than other insects (*Popillia japonica*) (Koppenhöfer and Fuzy, 2008). This difference could also account for *G. mellonella* tending to be the most attractive insect to EPNs in this experiment. The second highest mortality was observed in *T. molitor* pupae. This finding is probably due to the fact that *T. molitor* pupae do not move around as much as the larvae, they have a softer cuticle especially when they are newly moulted, and have a more rugged body structure compared to the larval stage. These features are believed to have aided penetration into the pupae by nematodes. However, *T. molitor* larvae have a waxy cuticle with more chitin compared to the other two groups tested, suggesting why the lowest mortality at shorter exposure times was observed amongst them. In addition to the aforementioned, certain lipids in insect diets have also been shown to promote host susceptibility and infection rates (Shapiro-Ilan et al., 2008). This is the case of *G. mellonella* diet used in this experiment. These characteristics may explain the variation in mortality patterns observed in this study.

Data obtained after 72 and 96 hrs post larvae exposure to IJs revealed that mortality was still recorded at lower IJ doses. Caroli et al. (1996) observed that for susceptible larvae such as *G. mellonella* and other lepidopterans, complete mortality was reached within 24-72 hrs of exposure to nematodes at concentrations similar to those used in this study. In addition Caroli et al. (1996) also observed that the time necessary for *H. bacteriophora* and *H. zealandica* to cause 50-90% mortality was determined after 24 hrs of exposure to higher concentrations of nematodes. In most other treatments, complete mortality was obtained after 96 hrs. However both Heterorhabditid nematodes tested in this study were virulent enough to kill over 95% of the insect host.

Results from the progeny production indicated large variations in the number of EPNs production. It was suggested that one of the criteria

for determining host suitability is the level of IJ reproduction following infection (Salame et al., 2010). According to Flanders et al. (1996), *H. bacteriophora* can be reared by *in vivo* methods; with yields of 567 000 IJs per *G. mellonella*. Hazir et al. (2001) reported 80,000 IJs while Shapiro-Ilan et al. (2001) reported up to 300,000 IJs having been harvested from one last instar *G. mellonella* larvae. These insect hosts are eminently suitable because they are susceptible, easily reared in the laboratory and widely available from many commercial sources (Hazir et al., 2003). Other than *G. mellonella*, the most commonly used host for *in vivo* culture is *T. molitor*, but little research has been reported on IJ production in this host. Yields of 115538 *H. bacteriophora* progeny per insect have been reported (Shapiro-Ilan and Gaugler, 2002). Compared to these authors, the numbers of IJs observed in larvae (*G. mellonella*, *T. molitor* and pupae) exposed to IJs of *H. zealandica* and *H. bacteriophora* was almost similar. In addition, the results indicated that IJ progeny production differed among the three larvae hosts, the IJ doses they were exposed to, as well as the EPN species (Figs 7-8). However, there was no relationship between progeny number and dosage. In fact, compared to *T. molitor* larvae and pupae, *H. zealandica* progeny in *G. mellonella* was consistently higher (mean \pm SEM: 220500-133933 IJs/*G. mellonella* larva), (mean \pm SEM: 152133-45467/ *T. molitor* larva and mean \pm SEM: 103366-56933 IJs / pupae) respectively. However, in the case of *H. bacteriophora*, progeny IJ production was similar in the *G. mellonella* and *T. molitor* larvae (all on average regardless of IJ dose larvae was exposed to, mean \pm SEM: 197666-101033/ *G. mellonella* mean \pm SEM 147933-109900/ *T. molitor* larvae). Closer rearing in the laboratory of *H. zealandica* and *H. bacteriophora* with *G. mellonella* could have led to higher reproductive potential with such hosts (Shapiro-Ilan and Gaugler, 2002). IJs production in *T. molitor* was reduced in *H. zealandica*-infected cadavers at 5, 10, 25, 50, 400 and 500 exposure doses than in the pupae (mean \pm SEM: 46200-13533 and mean \pm SEM: 103366 56933) respectively. However, low reproductive rates of the EPNs population from insect hosts may indicate that these populations are not suitable for use against these particular insect pests. The number of progeny IJs emerging from host insects should be considered for further development of a particular EPN strain for commercial use (Salame et al., 2010). Poor reproduction of EPNs may hamper their cost effectiveness in large-scale propagation systems (Ehlers, 2001). Environmental factors such as temperature, aeration and moisture could also explain the differences in yield (Georgis et al., 2006). Adequate aeration is necessary for

nematode development. Moisture level, for instance, high humidity levels, must be maintained throughout the production cycle (Woodring and Kaya, 1988) in the White trap. The substrate must remain sufficiently moist to prevent cadaver desiccation and allow emerging IJs to migrate, yet too much water will prevent movement and interfere with oxygen exchange (Shapiro-Ilan and Gaugler, 2002).

5. Conclusions

Susceptibility screening under laboratory conditions, as reported here, is needed to facilitate isolation of indigenous EPNS which are highly virulent to arthropod pests, for developing efficient and minimal usage of chemical pesticides and providing a more environmentally friendly method for the management of the crop. Studies under more natural conditions will be conducted in the next phase to evaluate the range of conditions under which these biological control agents might be utilized, and to develop a more accurate prediction of their effectiveness. Despite the virulence factors involved and the response of the insects, it seems clear that the pathogenic process developed by *H. zealandica* must be considered as being distinct from that of *H. bacteriophora*. Further work is necessary to study the host range and the ecological requirements of the strain, as well as the virulence of its symbiotic bacteria.

Acknowledgement:

The authors wish to acknowledge the National Research Foundation (NRF) Innovation Fund South Africa for funding this project. Also thanks to two anonymous reviewers whose comments improved this manuscript.

Correspondence to:

Dr. L. Ngoma
School of Environmental and Health Sciences,
Department of Biological Sciences, Faculty of
Agriculture Science and Technology, North-West
University – Mafikeng Campus, P. Bag X2046
Mmabatho 2735, South Africa.
Tel: +27183892568; Fax: +27183892134
Emails: jclubanza@yahoo.co.uk or
jclubanza@hotmail.com

References

1. Abdel-moniem ASH, Gesraha MA. (2001). Evaluation of certain entomopathogenic nematodes against the melon ladybird, *Epilachna chrysomelina* F. (coleoptera: coccinellidae). *Archiv. Phytopath. Pflanz.* 34: 327-336.
2. Aydin H, Susurluk A. (2005). Competitive Abilities of the Entomopathogenic Nematodes *Steinernema feltiae* and *Heterorhabditis bacteriophora* in the same host at different temperatures. *Turk. J. Biol.* 29: 35-39.
3. Campos-Herrera R, El-Borai FE, Stuart RJ, Graham JH, Duncan LW. (2011). Entomopathogenic nematodes, phoretic *Paenibacillus* spp., and the use of real time quantitative PCR to explore soil food webs in Florida citrus groves. *J. Invertebr. Pathol.* 108: 30-39.
4. Caroli L, Glazer I, Gaugler R. (1996). Entomopathogenic nematode infectivity assay: multi variable comparison of penetration into different hosts. *Biocontrol. Sci. Techn.* 6: 227-233.
5. Ehlers RU. (2001). Mass production of entomopathogenic nematodes for plant protection. *Appl. Microbiol. Biot.* 56: 623-633.
6. Ehlers RU. (2007). Entomopathogenic nematodes: from science to commercial use. *Biol. Control.* 13: 136-151.
7. Flanders KL, Miller JM, Shields EJ (1996). In vivo production of *Heterorhabditis bacteriophora* 'Oswego' (Rhabditida: Heterorhabditidae), a potential biological control agent for soil-inhabiting insects in temperate regions. *J. Econ. Entomol.* 89:373-380.
8. Georgis R, Koppenhöfer AM, Lacey LA, Belair G, Duncan LW, Grewal PS, Samish M, Tan L, Torr P, Van Tol RWHM. (2006). Success and failures in the use of parasitic nematodes for pest control. *Biol. Control.* 38: 103-123.
9. Glazer I, Lewis EE. Bioassays for entomopathogenic nematodes. (2000). In: Navon, A. and Ascher, KRS (eds) *Bioassays of Entomopathogenic Microbes and Nematodes*. CAB International, Wallingford, UK, pp 229-247.
10. Hazir S, Stock SP, Kaya HK, Koppenhöfer AM, Keskin N. (2001). Developmental temperature effects on five geographic isolates of the entomopathogenic nematodes *Steinernema feltiae* (Nematoda: Steinernematidae). *J. Invertebr. Pathol.* 77: 243-250.
11. Hazir S, Kaya HK, Stock P, Keskin N. (2003). Entomopathogenic Nematodes (Steinernematidae and Heterorhabditidae) for Biological Control of Soil Pests. *Turk. J. Biol.* 27: 181-202.
12. Kanga FN, Waeyenberge L, Hauser S, Moens M. (2012). Distribution of entomopathogenic nematodes in Southern Cameroon. *J. Invertebr. Pathol.* 109: 41-51.
13. Kaya HK, Stock SP. Techniques in Insect Nematology (1997). In: L. A. Lacey (ed.) *Manual of Techniques of Insect Pathogens*. Acad Press, pp 281-324.
14. Kaya HK, Aguilera MM, Alumai A, Choo YH, De la Torre M, Fodor A. (2006). Status of entomopathogenic nematodes and their symbiotic bacteria from selected countries or regions of the world. *Biol. Control.* 38: 134-155.

15. Koppenhöfer AM, Grewal PS, Fuzy EM. (2007). Differences in penetration routes and establishment rates of four entomopathogenic nematode species into four white grub species. *J. Invertebr. Pathol.* 35: 128-139.
16. Koppenhöfer AM, Fuzy EM. (2007). Soil moisture effects on infectivity and persistence of the entomopathogenic nematodes *Steinernema scarabaei*, *S. glaseri*, *Heterorhabditis zealandica*, and *H. bacteriophora*. *Appl. Soil. Ecol.* 35:128-139.
17. Koppenhöfer AM, Fuzy EM. (2008). Attraction of four entomopathogenic nematodes to four white grub species. *J. Invertebr. Pathol.* 99:227-234.
18. Malan AP, Nguyen KB, Addison MF. (2006). Entomopathogenic nematodes (Steinernematidae and Heterorhabditidae) from the southwestern parts of South Africa. *Afr. Plant. Protect.* 12: 65-69.
19. Malan AP, Nguyen KB, De Waal JY, Tiedt L. (2008). *Heterorhabditis safricana* n. sp. (Rhabditida: Heterorhabditidae), a new entomopathogenic nematode from South Africa. *Nematology.* 10: 381-396.
20. Millar LC, Barbercheck ME. (2001). Interaction between endemic and introduced entomopathogenic nematodes in conventional-till and no-till corn. *Biol. Control.* 22: 235-245.
21. Mwaitulo S, Haukeland S, Sæthre MG, Laudisoit A, Maerere AP. (2011). First report of entomopathogenic nematodes from Tanzania and their virulence against larvae and adults of the banana weevil *Cosmopolites sordidus* (Coleoptera: Curculionidae). *Int. J. Trop. Insect. Sci.* 31 (3): 154-161.
22. O'Hallaran DM, Burnell AM. (2003). An investigation of chemotaxis in the insect parasitic nematode *Heterorhabditis bacteriophora*. *Parasitology.* 127: 375-385.
23. Poinar Jr, GO. (1976). Description and biology of a new insect parasitic rhabditoid, *Heterorhabditis bacteriophora* n. gen. n. sp. (Rhabditida, Heterorhabditidae n. fam.). *Nematologica.* 21: 463-470.
24. Poinar Jr, GO. (1990). Taxonomy and biology of Steinernematidae and Heterorhabditidae, in *Entomopathogenic nematodes in biological control*, Eds. R. Gaugler and H.K. Kaya, Boca Raton, Florida: CRC Press, pp 23-61.
25. Rosa JS, Bonifassi E, Amaral J, Lacey LA, Simões N, Laumond, C. (2000). Natural occurrence of entomopathogenic nematodes (Rhabditida: *Steinernema*, *Heterorhabditis*) in the Azores. *J. Nematology.* 32: 215-222.
26. Salame L, Glazer I, Miqaia N, Chkhubianishvili T. (2010). Characterization of populations of entomopathogenic nematodes isolated at diverse sites across Israel. *Phytoparasitica.* 38:39-52.
27. Shapiro-Ilan DI, Lewis EE, Behle RW, McGuire MR. (2001). Formulation of Entomopathogenic Nematode-Infected Cadavers. *J. Invertebr. Pathol.* 78: 17-23.
28. Shapiro-Ilan DI, Gaugler R. (2002). Production technology for entomopathogenic nematodes and their bacterial symbionts. *J. Ind. Microbiol. Biotechnol.* 28:137-146.
29. Shapiro-Ilan D, Rojas MG, Morales-Ramos JA, Lewis EE, Tedders WL. (2008). Effects of host nutrition on virulence and fitness of entomopathogenic nematodes: Lipid and protein based supplements in *Tenebrio molitor* diets. *J. Nematol.* 40:13-19.
30. Shapiro-Ilan DI, Lewis EE, Campbell JF, Kim-Shapiro DB. (2012). Directional movement of entomopathogenic nematodes in response to electrical field: effects of species, magnitude of voltage, and infective juvenile age. *J. Invertebr. Pathol.* 109: 34-40.
31. Spence KO, Stevens GN, Arimoto H, Ruiz-Vega J, Kaya HK, Lewis EE. (2011). Effect of insect cadaver desiccation and soil water potential during rehydration on entomopathogenic nematode (Rhabditida: Steinernematidae and Heterorhabditidae) production and virulence. *J. Invertebr. Pathol.* 106: 268-273.
32. Stack CM, Easwaramoorthy SG, Metha UK, Downes MJ, Griffin CT, Burnell AM. (2000). Molecular characterisation of *Heterorhabditis indica* isolates from India, Kenya, Indonesia and Cuba. *Nematology.* 2(5): 477-487.
33. Stock SP, buckner J, Grossmiller L, Coyne P. (2003). Nematodes in oak woodlands from Southern Arizona's sky islands. *J. Nematol.* 35: 365.
34. Wang Y, Campbell JF, Gaugler R. (1995). Infection of entomopathogenic nematode *Steinernema glaseri* and *Heterorhabditis bacteriophora* against *Popillia japonica* (Coleoptera, Scarabaeidae) larvae. *J. Invertebr. Pathol.* 66: 178-184.
35. Woodring JL, Kaya HK. (1988). Steinernematid and Heterorhabditid Nematodes: A Handbook of Biology and Techniques. Southern Cooperative Series Bulletin, Arkansas Agricultural Experiment Station. Fayetteville, Arkansas, pp 1-17.

02/11/2012

Secured disclosure of data in multiparty clustering

G. Kirubhakar¹, Dr. C. Venkatesh²

¹ Department of Computer Science and Engineering, Surya Engineering College, Erode, Tamilnadu, India

¹ ergalaxy81@gmail.com, kirubhakarg@gmail.com

² Dean, Faculty of Engineering, Erode Builder Educational Trust's Group of Institutions, Kangayam, Tamilnadu, India

² dean.foe@ebet.edu.in

Abstract: Data mining can extract important knowledge from large data collections sometimes these collections are distributed among multiple parties. Privacy concerns may prevent the parties from directly sharing the data and some type of information about data. This work presents a distributed privacy-preserving k-clustering. K-means were used for clustering and that will be applied to the data bases that are distributed between many parties. The participants of the protocol learn only the final cluster centers on completion of the protocol. It uses data perturbation techniques for securing the information about data.

[G. Kirubhakar, C. Venkatesh. **Secured disclosure of data in multiparty clustering.** *Life Sci J* 2012;9(4):2580-2585]. (ISSN: 1097-8135). <http://www.lifesciencesite.com>. 383

Keywords: security, privacy, data dissemination, clustering, multiparty

1. Introduction

With the development of data analysis and processing technique, organizations, industries and governments are increasingly publishing micro data (i.e., data that contain non aggregated information about individuals) for data mining purposes, studying disease outbreaks or economic patterns. While the released datasets provide valuable information to researchers, they also contain sensitive information about individuals whose privacy may be at risk (P. Samarati, 2001).

Now a day's these data bases are distributed among several sites. Data mining techniques on distributed data bases however reveals sensitive information about individuals. Here the concept of securing data mining comes.

Securing distributed data mining allows cooperative computation of data mining algorithms without requiring the participating organizations to reveal their individuals data items to each other (D.Aruna, 2011).

2. Problem Definition

Recent advances in data collection, data dissemination and related technologies have inaugurated a new era of research where existing data mining algorithms should be reconsidered from the point of view of privacy preservation. The need for privacy is sometimes due to law (e.g., for medical databases) or can be motivated by business interests. However, there are situations where the sharing of data can lead to mutual benefit.

Despite the potential gain, this is often not possible due to the confidentiality issues which arise. It is well documented that the unlimited explosion of

new information through the Internet and other media has reached a point where threats against privacy are very common and deserve serious thinking.

Consider a scenario that there are several hospitals involved in a multi-site medical study. Each hospital has its own data set containing patient records. These hospitals would like to conduct data mining over the data sets from all the hospitals with the goal of obtaining more valuable information via mining the joint data set. Due to privacy laws, one hospital cannot disclose their patient records to other hospitals. How can these hospitals achieve their objective? Can privacy and collaborative data mining coexist? In other words, can the collaborative parties somehow conduct data mining computations and obtain the desired results without compromising their data privacy? We show that privacy and collaborative data mining can be achieved at the same time.

Common examples arise in health science, where data may be held by multiple parties: commercial organizations (such as drug companies, or hospitals), government bodies (such as the Food and Drug Administration) and non-government organizations (such as charities). Each organization is bound by regulatory restrictions (for instance privacy legislation), and corporate requirements (for instance on distributing proprietary information that may provide commercial advantage to competitors). In such a case, an independent researcher may not receive access to data at all, while even members of one of these organizations see an incomplete view of the data. However, data from multiple sources may be needed to answer some important questions. A classical example occurs for an organization like the CDC (Center for Disease Control and Prevention), who are mandated

with detecting potential health threats, and to do so they require data from a range of sources (insurance companies, hospitals and so on), each of whom may be reluctant to share data.

3. Literature Survey

The problem of secured data mining has found considerable attention in recent years because of the recent concerns on the privacy of underlying data (V.S.Verykios, 2004).

Various secured data mining techniques fall under:

- *K*-Anonymity
- Cryptographic techniques
- Randomized Response techniques
- Data modification

Many recent papers on privacy have focused on the perturbation model and its variants. Methods for inference attacks in the context of the perturbation model have been discussed by Acerkerman.M.S (1999).

A number of papers have also appeared on the *k*-anonymity model recently. Other related works discuss the method of top-down specialization for privacy preservation, and workload-aware methods for anonymization (W.Du, 2004).

Agrawal (2000) develops a new distribution-based data mining algorithm for the classification problem, whereas the techniques in Vaidya and Clifton (2002) and Rizvi and Haritsa (2002) develop methods for privacy-preserving association rule mining.

Another branch of privacy preserving data mining which uses cryptographic techniques was developed (S.Laur, 2006).

Randomized Response technique was first introduced by Warner as a technique to solve a survey problem (H.Polat, 2005).

In condensation approach, data modification is used in order to modify the original values of a database that needs to be released to the public and in this way ensure high privacy protection (V.S. Verykios, 2004).

The goal of this paper is to present technologies to solve security related data mining problems over large data sets at multiple sites or parties with reasonable efficiency.

4. Materials and Methods

4.1. Cluster Analysis

Clustering is an important data mining problem. The goal of clustering, in general, is to discover dense and sparse regions in a dataset. Most previous work in clustering focused on centralized data whose inherent geometric properties (V.S. Verykios, 2004) can be exploited to naturally define distance functions between points. Recently, the problem of clustering at distributed sites started receiving interest.

4.2. Proposed System

1) *Data partitioning methods*: There are two distinct situations that demand the need for effecting cluster analysis in a distributed way. The first occurs when the volume of data to be analyzed is relatively great, which demand a considerable computational effort, which sometimes is even unfeasible, to accomplish this task.

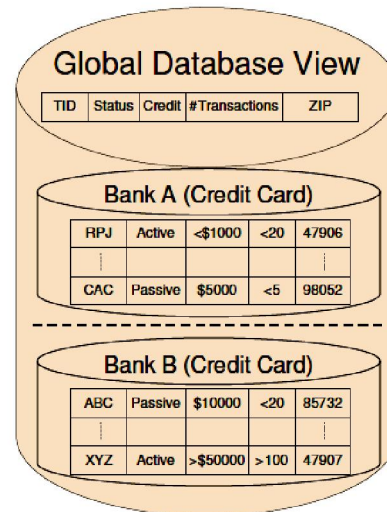

Fig.1. Database partitioning

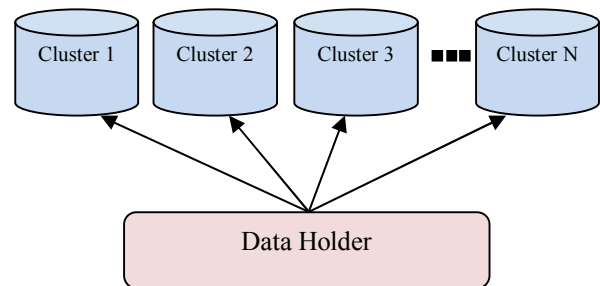

Fig.2. Multiparty clustering

The best alternative, then, is splitting data, cluster them in a distributed way and unify the results. The second occurs when data is naturally distributed among several geographically distributed units and the cost associated to its centralization is very high as in Fig. 1. Certain current applications hold databases so large, that it is not possible to keep them integrally in the main memory, even using robust machines.

Kantardzic (2002) presents three approaches to solve this problem:

a) Storing data in a secondary memory and clustering data subsets separately. Partial results are

kept and, in a posterior stage, are gathered to cluster the whole set;

b) Using an incremental clustering algorithm, in which every element is individually brought to the main memory and associated to one of the existing clusters or allocated in a new cluster. The results are kept and the element is discarded, in order to grant space to the other one as shown in Fig. 2.;

c) Using parallel implementation, in which several algorithms work simultaneously on stored data, increasing efficacy.

In cases in which the data set is unified and needs to be divided in subsets, due to its size, two approaches are normally used: horizontal and vertical partitioning (Fig. 3 and 4).

Fig.3. Horizontal partitioning

	x_1	x_2	x_3	x_4	x_5	x_6
1						
...						
m						
<hr/>						
m+1						
m+2						
...						
p						

	x_1	x_2	x_3	x_4	x_5	x_6
1						
...						
m						
m+1						
m+2						
...						
p						

Fig.4. Vertical partitioning

The first approach is more used and consists in horizontally splitting database, creating homogeneous data subsets, so that each algorithm operates on different records considering, however, the same set of attributes. Another approach is vertically dividing the database, creating heterogeneous data subsets; in this case, each algorithm operates on the same records, dealing, however, with different attributes.

2) *General aims of partitioning and placement:* Before proceeding, a few definitions of the terminology used are in order. Partitioning (also known as fragmentation) is the fragmentation of a relational table into subsets, called partitions as in Fig. 5. Placement is the assignment of these partitions to physical storage media. The collective term for these is

allocation. Note that some workers use the term partitioning to mean allocation. The general aims of data partitioning and placement in database machines are to

1. reduce workload (e.g. data access, communication costs, search space)
2. balance workload
3. speed up the rate of useful work (e.g. frequently accessed objects in main memory)

3) *Data perturbation:* It can be broadly divided into two sets of techniques – probability distribution, which is not dealt with here, and fixed-data perturbation, designed specifically for numerical/categorical (not statistical) data. Fixed-data perturbation methods usually generate an entirely new database, for secondary use. In their simplest form, only a single attribute is perturbed – but techniques also exist for the transformation of multiple attributes.

City	Country	Region
Lisbon	Portugal	Europe
London	United Kingdom	Europe
Seattle	United States	North America
Los Angeles	United States	North America

City	Country	Region	City	Country	Region
Lisbon	Portugal	Europe	Seattle	United States	North America
London	United Kingdom	Europe	Los Angeles	United States	North America

Fig.5. Partitioned entities

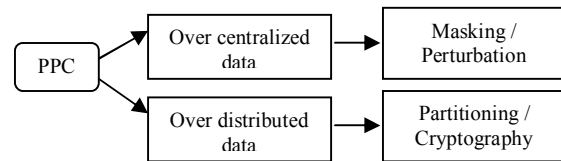

Fig.6. A taxonomy of data mining security solutions

4.3. Security Primitives and Data Perturbation

Taxonomy of data mining security solutions is shown in Fig. 6 and perturbation is one among them which is taken into account in this work.

4.4. Algorithms

The central idea of general k-means clustering (Algorithm 1) is as follows:

- | |
|---|
| <p>Algorithm 1: Centralized K-means Clustering</p> <ol style="list-style-type: none"> 1. Select K points as initial centroids 2. repeat 3. Form K clusters assigning all points to closest centroid 4. Recompute the centroid of each cluster |
|---|

The central idea of proposed algorithm (Algorithm 2) is similar to the one proposed by (D.Aruna, 2011). The algorithm is as follows: This algorithm is used as a function in k-means clustering algorithm to securely compute the nearest cluster for the given entity i.e. to which cluster should an entity to be assigned. This algorithm is invoked for every single entity in each iteration. Each party has its input data, the distance component corresponding to each of the k clusters i.e. which is equivalent of having a matrix of distances of dimensions $r \times k$. Euclidean distance measure is used to compute the distance between the entity and the cluster centroid.

Algorithm 2: Multiparty K-means Clustering

1. DH splits and secures data by random perturbation
2. DH distributes secured data to all parties
3. Each party performs clustering separately
4. Each party returns intermediate centroids

Data Holder(DH) applies the random perturbation on the splitted data and publishes to all other parties. Each party selects randomly m number of entities from the dataset as initial starting points and every party computes the local distances of their attributes for k clusters. Since there are many parties and each of them sends the computed intermediate centroid to party DH.

Then compute closest cluster algorithm is described in Algorithm 3 below.

Algorithm 3: Merge and Compute closest cluster

1. DH uses centroids collected as initial centroids
2. Performs clustering on the whole data
3. DH computes final centroids

DH combines all randomized masked local distances with respect to each entity and compares the masked local distances with k cluster and assigns the entity to the closest cluster. The final output of privacy preserving k-means clustering algorithm is that all the parties will know to which cluster each entity is assigned.

5. Measurements

This experiment is performed in two phases. In the first phase, the data mining task-clustering is performed centralized without securing the sensitive details. In the second phase, the same data mining task-clustering is performed among multiparty in a distributed manner by securing the sensitive attributes.

For Youtube dataset, the data quality of the secured dataset is then compared with the data quality

of the original dataset for estimating the effectiveness of secured disclosure in preserving the patterns.

The same experiment performed in many runs at varying entity counts, security levels, party counts and accuracy levels are noted. The attributes of the entities are distributed among parties equally or unequally, which does not show any effect on the algorithms. The proposed algorithm is applied to Youtube user dataset consist of 5000 entities and 4 attributes for each entity. The clustering results in both centralized and multiparty modes are shown below.

The various experimental results are shown for 5000 records in Tables 1-4 and Fig. 7 and 8, which conclude that the results are likely to be fine at entity count more than 1000 having multiparty cluster levels around 5 with perturbation security level around 10%.

6. Results

Data set taken: Youtube data set

Number of attributes: 4

Sensitive attributes: Uploads, Watches

Data mining task examined: Clustering Number of entities: 5000

Number of parties: 5

Security method: Partitioning and Perturbation

Security level: 10%

6.1. Detailed results

6.1.1. Centralized clustering

32 iterations

Elapsed Time - 34.468750

Table 1: Centralized clustering detailed results

Clusters	Centroids	Entities
C1	17, 2453	393
C2	28, 5236	105
C3	9, 167	3445
C4	28, 21474	9
C5	15, 1002	1048

6.1.2. Multiparty Clustering

Table 2: Multiparty clustering detailed results

Sites	Initial Centroids
Site1	11,668
Site2	11,689
Site3	9,611
Site4	13,602
Site5	11,764

6.2. Merging multiparty results

32 iterations

Elapsed Time - 30.671875

6.3. Brief comparison results

Table 3: Time elapsed comparison results

Entities	Centralized	Distributed
6	1.28	1.28
10	3.55	3.16
500	10.54	9.53
1000	22.13	21.75
5000	34.47	30.67

Table 4: Iterations comparison results

Entities	Centralized	Distributed
6	3	2
10	6	5
500	10	11
1000	20	20
5000	32	34

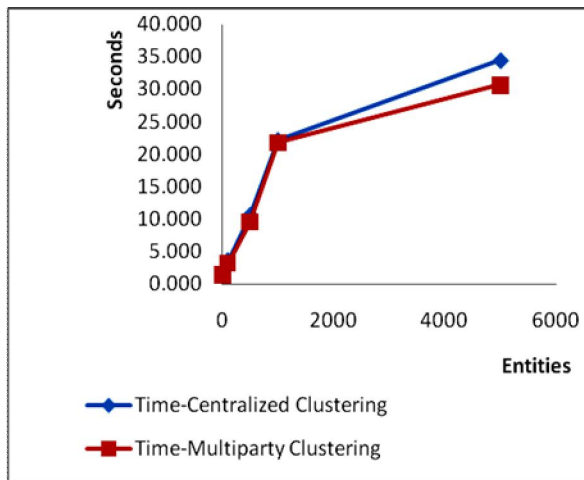

Fig. 7: Graphical Results: Entities vs. Time

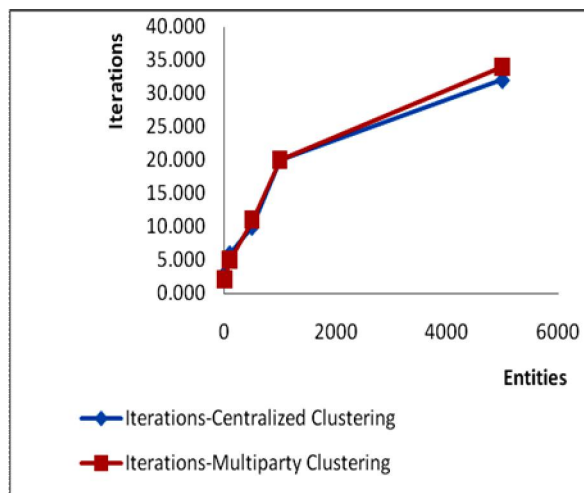

Fig. 8: Graphical Results: Entities vs. Iterations

Experiments show that this method can greatly improve the privacy quality without sacrificing accuracy.

7. Conclusion

It appears that complete privacy is impossible to maintain while allowing useful data-mining. To allow complete privacy makes data-mining results completely unreliable, whilst enabling accurate data-mining results in an unacceptable threat to the privacy of individuals. Data-mining is nevertheless a useful and vitally important pursuit, and thus techniques which maximize accuracy of results, while minimizing the threats to privacy, will become increasingly important.

To best knowledge this is the first effort toward a building block solution for the problem of privacy preserving data clustering. The performance evaluation experiments demonstrated that the methods are effective and provide practically acceptable values for balancing privacy and accuracy. The transformed database is available for secondary use and must hold the following restrictions: (a) the distorted database must preserve the main features of the clusters mined from the original database; (b) an appropriate balance between clustering accuracy and privacy must be guaranteed. The results of the investigation clearly indicate that the methods achieved reasonable results and are promising.

This work can be extended in two directions: (a) combining cryptography and perturbation to increase both accuracy and privacy; (b) designing new methods for privacy preserving clustering when considering the analysis of confidential categorical attributes, which requires further exploration.

Authors:

Kirubhakar.G currently working as Assistant Professor in Surya Engineering College, Erode, is a research scholar under Anna University of Technology, Coimbatore. He has received his Bachelor's degree in 2002 from Amrita Institute of Technology, Coimbatore and Master's degree in computer science from Kongu Engineering College, Perundurai during 2007. He secured **16th rank** in Anna University, Chennai during his Post graduate studies. His research interest includes data mining, web technology and security techniques.

Dr. C. Venkatesh, Dean, Faculty of Engineering, Erode Builder Educational Trust's group of Institutions, Kangayam, graduated in ECE from Kongu Engineering College in the year 1988, obtained his Master's degree in Applied Electronics from Coimbatore Institute of Technology, Coimbatore in the year 1990. He was awarded Doctorate in ECE from

Jawaharlal Nehru Technological University, Hyderabad in 2007. He has a credit of two decade of experience which includes around 3 years in industry. He has 16 years of teaching experience during tenure he was awarded **Best Teacher Award** twice. He was the founder Principal of Surya Engineering College, Erode. He is guiding 10 Ph.D., research scholars. He is a Member of IEEE, CSI, ISTE and Fellow IETE. He has Published 13 papers in International and National Level Journals and 50 Papers in International and National Level conferences. His area of interest includes Soft Computing, Sensor Networks and communication.



References

- [1] P. Samarati, 2001. Protecting respondent's privacy in micro data release. IEEE Transaction on Knowledge and Data Engineering. DOI: 10.1109/69.971193. pp: 1010 – 1027.
- [2] D.Aruna Kumari, Dr.K.Rajasekhar Rao, M.Suman, May 2011. Distributed data mining: A new Approach using Steganography techniques. CIT International journal of Research and educations. ISSN: 2230-9144.
- [3] V. S. Verykios, E. Bertino, I. N. Fovino, L. P. Provenza, Y. Saygin, and Y. Theodoridis, 2004. State of the art in privacy preserving data mining. Proceedings of ACM SIGMOD. DOI: 10.1145/974121.974131. pp: 50 – 57.
- [4] Ackerman, M. S., Cranor, L. F., and Reagle, J, 1999. Privacy in ecommerce: examining user scenarios and privacy preferences. Proceedings of Electronic Commerce. DOI: 10.1145/336992.336995. pp: 1-8.
- [5] W. Du, Y. Han, and S. Chen, 2004. Privacy preserving multivariate statistical analysis: Linear regression and classification. Proceedings of the Fourth SIAM International Conference on Data Mining. DOI: 10.1.1.38.595. pp: 222-233.
- [6] Agrawal, R. and Srikant, R, 2000. Privacy-preserving data mining. Proceedings of SIGMOD00. DOI: 10.1145/342009.335438. pp: 439-450.
- [7] J. Vaidya and C. Clifton, 2002. Privacy preserving association rule mining in vertically partitioned data. Eighth ACM SIGKDD International conference on Knowledge Discovery and Data Mining, Edmonton, Alberta, CA. DOI: 10.1145/775047.775142. pp: 639-644.
- [8] S. Laur, H. Lipmaa, and T. Mielikainen, 2006. Cryptographically private support vector machines. Twelfth ACM SIGKDD International Conference on Knowledge Discovery and Data Mining. DOI: 10.1145/1150402.1150477. pp: 618-624.
- [9] Kantardzic M., Djulbegovic B., Hamdan H., September 2002. A Data Mining Approach to Improving Polycythemia Vera Diagnostics. Computers and Industrial Engineering, Volume 43, Issue 4. pp. 765-777
- [10] D.Aruna Kumari, Dr.K.Rajasekhar rao, M.Suman, May 2011. Privacy preserving clustering in data mining using vector quantization. Research journal of Computer science and engineering (RJCSE). ISSN : 2230-8563

10/22/2012

Identifying and Prioritization Effective Factors in TQM implementation Using AHP and DEMATEL Methods

¹Reza Kiani mavi, ^{2*}Shahram madanshekaf, ³Kiamars Fathi Hafshejani, ⁴Davood Gharakhani

¹Assistant Professor, Department of Industrial Management, Qazvin branch, Islamic Azad University (IAU), Qazvin, Iran

^{2*}Department of Industrial Management, Qazvin branch, Islamic Azad University (IAU), Qazvin, Iran
Shahram madanshekaf (Corresponding author)

³Assistant Professor, Department of Management, South Tehran Branch Islamic Azad University (IAU), Tehran, Iran

⁴Department of Industrial Management, Qazvin branch, Islamic Azad University (IAU), Qazvin, Iran

Abstract: The purpose of this paper is Identifying and Prioritization Effective Factors in TQM implementation Using AHP and DEMATEL Methods. TQM is universally accepted as one of the most understood change management programmes and is one of the strategies for confronting the global competitive challenge facing both manufacturing and service industries. The study involved a comprehensive literature survey as well as information and data collected in the Golrang Company in Iran. In this study were used two types of questionnaires, AHP questionnaire and DEMATEL questionnaire. After identified the hierarchical decision tree, In order to gather these data, AHP questionnaire is designed and distributed among 15 experts in Golrang Company. The study result shows that the main factors in TQM implementation are Management factors and quality factors (by AHP approach) and effective factors are Top management support and Quality management process (by DEMATEL approach).

[Reza Kiani mavi, Shahram madanshekaf, Kiamars Fathi Hafshejani, Davood Gharakhani. **Identifying and Prioritization Effective Factors in TQM implementation Using AHP and DEMATEL Methods.** *Life Sci J* 2012;9(4):2586-2592]. (ISSN: 1097-8135). <http://www.lifesciencesite.com>. 384

Keywords: Total quality management, Analytic hierarchy process, DEMATEL

1. Introduction

Total quality management (TQM) is a holistic approach that seeks to integrate all organizational functions to focus on meeting customer needs and organizational objectives through the improvement of quality, productivity and competitiveness (Pfau, 1989). TQM philosophy emphasizes the role of internal and external customers and suppliers, and the involvement of employees in pursuit of continuous improvement (Oakland et al., 2002; Chang, 2006). Despite some criticism, TQM has gained widespread acceptance in both the academic and business communities (Claver et al., 2003; Chang, 2006). Extensive research focuses especially on the role of performance measurement in the context of TQM. Organizations wishing to implement TQM face therefore a necessity of profound changes in performance measurement (Sinclair and Zairi, 1995) and are in need of guidance and better understanding of the role of different performance measurement methods and systems. The objective of this paper is to provide guidance for future TQM adopters through investigation of existing practices implemented by a group of finalists in the total quality category of Canada Awards for Business Excellence. However, very often TQM has gone from buzzword to fad in many people's opinion (Bergquist et al., 2005). It is widely accepted that TQM emphasizes self-control,

autonomy, and creativity among employees and requires active co-operation rather than mere compliance. In addition, TQM theory supports that internal and external information should be equally shared among all employees in order to encourage them to become responsible for quality improvement. However, although many articles have been written about the "basic principles and tools" of TQM and the various approaches taken to assure a successful implementation of TQM according to Dayton (2003) continue to remain complex and somewhat clouded.

TQM is still in the early stages of theory development. Furthermore, the future theoretical development incorporating "appropriate management theories" is still to come until TQM can reach a "refined" stage of development. TQM aims to provide organizations with a template for success through customer satisfaction. TQM initiatives must include an in-built culture of continuous improvement, which can help an organization satisfy the needs of its customers on an ongoing basis (Walsh et al., 2002). The concept of TQM provides the approach to realize the manufacturing strategy leading to fulfilment of corporate strategy. The principles and contents of TQM philosophy would increase a firm's commitment to quality and if they are applied correctly enhances the firm's competitive position. This is because the TQM principles support the business practices of cost

reduction, enhanced productivity, and improved quality of the products/outputs – i.e., it helps to support and fulfil the concept of excellence in manufacturing. Literature on TQM advocates the influence of human factors more as compared to other factors on implementation of TQM and business performance. Saad and Siha (2000) feel the visible (or tangible) variables such as technology, structure and strategy have a relatively small impact on TQM effectiveness compared with largely hidden and intangible variables such as values, attitudes and perception. These factors have also been classified as hard and soft elements or hardware and software determinants. Improvement in the soft elements is important since there is adequate research proving that business performance is more heavily influenced by these elements of TQM (Gotzamani and Tsiotras, 2001). The TQM concept is used by an increasing number of organizations to this end. The available empirical evidence also supports the assertion that implementation of TQM improves the profitability and competitive position of the organization.

2. Literature review

2.1. TQM literature

Total quality management (TQM) is considered by many to be the management paradigm capable of facilitating the attainment of continuous improvement and external focus. This accounts for the attention paid to TQM by all sides of commerce and industry, politicians and academics. One manifestation of this interest is the large number of quality-related articles appearing in a wide variety of academic, practitioner and general interest publications. TQM implies good decisions and correct action by managers in creating an environment that empowers workers and fosters the continuous improvement of all organizational processes in and among various functional areas. TQM is universally accepted as one of the most understood change management programmes and is one of the strategies for confronting the global competitive challenge facing both manufacturing and service industries. Numerous frameworks have been

proposed for TQM implementation elements and various studies have also been carried out to identify elements for the successful manifestation of TQM in an organization. TQM was frequently cited as a strategic option for achieving competitive advantage in the 1990s, yet it had received little attention in the evolving enterprise environments of integrated SCM and e-commerce. SCM has generally been associated with modern materials management, advanced information technologies, rapid and responsive logistics service, effective supplier management, and increasingly with customer relationship management (Fawcett and Magnan, 2002). Taveira et al. (2003) examined hypotheses regarding influence of TQM on work environment and concluded that most TQM elements were significantly related to work environment scales viz. supervisor support, task orientation, task clarity and innovation. Testa et al. (2003) did regression analysis to suggest national and organizational cultural congruence has positive effect on job satisfaction. Specific dimensions of human factors have been covered by various other studies (Legge, 1995). However, the authors have not come across any literature on mathematical modeling of different human aspects in TQM leading to single numerical index. Total quality management (TQM) has received worldwide acceptability and recognition. The core values of TQM, integrating all the interacting components in an organization, are applicable to any size of organization – large or small, any type of organization – manufacturing or service, private or public. However, preparation for realizing the fruits of TQM is challenging, since it is a multifaceted and complex phenomenon involving every facility and every individual at all levels.

2.2. Effective Factors in TQM implementation

Based on the previous literature review, we focus on four main aspects including. From these main aspects, 16 influential factors for the TQM implementation. The classification of those main aspects and their influential factors are shown in Table 1.

Main aspect	Influential factors	Reference
Management factors	Top management support	Saraph et al. (1989), Flynn et al. (1994), Ahire et al.(1996), Zeitz et al.(1997), Tamimi (1995), Motwani (2001), Antony et al. (2002), Zhang (2000), Quazi et al. (1998), Gaddene and Sharma (2009), Koh and Low (2010)
	Supplier quality management	Saraph et al. (1989), Flynn et al. (1994), Ahire et al.(1996), Black and Porter (1996), Powell (1995), Das et al. (2008), Koh and Low (2010)
	Training	Saraph et al. (1989), Flynn et al. (1994), Powell (1995), Zhang (2000), Quazi et al. (1998), Gaddene and Sharma (2009), Black and Porter (1996)
	Employee participation	Saraph et al. (1989), Ahire et al.(1996), Zeitz et al.(1997), Black and Porter (1996), Quazi et al. (1998), Rao et al. (1999), Das et al. (2008)
	Organizational performance	Ngai and Cheng (1997) Black and Porter (1996), Flynn et al. (1994), Antony et al. (2002), Koh and Low (2010)
	Planning, policies	Ahire et al.(1996), Black and Porter (1996), (Zink and Voss, 1998), Amar and Zain

Organizational factors	and strategies	(2002), (Tan and Khoo, 2002)
	teamwork	Saraph et al. (1989), Ahire et al.(1996), Zeitz et al.(1997), (Zink and Voss, 1998), (Tan and Khoo, 2002)
	Organizational Structure	Quazi et al. (1998), Gaddene and Sharma (2009), Black and Porter (1996), Rao et al. (1999), Antony et al. (2002)
Process factors	Quality management process	Black and Porter (1996), Powell (1995), Flynn et al. (1994), Ahire et al.(1996), Quazi et al. (1998), Rao et al. (1999), Zeitz et al.(1997), Tamimi (1995), Das et al. (2008), Koh and Low (2010)
	Product/service design	Saraph et al. (1989), Flynn et al. (1994), Ahire et al.(1996), Black and Porter (1996), Rao et al. (1999), Motwani (2001), Zhang (2000)
	Customer Satisfaction	Saraph et al. (1989), Ahire et al.(1996), Black and Porter (1996), Antony et al. (2002), Zhang (2000)
	benchmarking	Saraph et al. (1989), Ahire et al.(1996), Rao et al. (1999), Motwani (2001), Gaddene and Sharma (2009), Das et al. (2008)
Quality factors	Role of the quality department	Saraph et al. (1989), Ahire et al.(1996), Black and Porter (1996), Rao et al. (1999), Antony et al. (2002)
	Continuous Improvement	Saraph et al. (1989), Ahire et al.(1996), Motwani (2001), Rao et al. (1999), Gaddene and Sharma (2009), Das et al. (2008)
	Quality data and reporting	Saraph et al. (1989), Flynn et al. (1994), Ahire et al.(1996), Zeitz et al.(1997), Black and Porter (1996), Powell (1995), Antony et al. (2002), Koh and Low (2010)
	Quality Culture	Black and Porter (1996), Amar and Zain (2002), Ngai and Cheng (1997)

2.3. Analytic hierarchy process

The AHP was developed by Thomas L. Saaty at the Wharton School of Business in 1970s. It is an effective decision-making technique based on multi-criteria decision-making methodology. The AHP is perhaps, the most widely used decision-making approach in the world and its validity is based on the many thousands of actual applications in which the AHP results were accepted and used by the cognizant decision makers (Saaty, 1994a). AHP is a method of breaking down a complex, unstructured situation into its component parts, arranging these parts or judgments on the relative importance of each variable and synthesizing the judgments to determine which variables have the highest priority and should be acted upon to influence the outcome of the situation (Saaty, 1990). It is a measurement theory that can deal with quantitative and qualitative criteria (Vargas, 1990). AHP is a systematic procedure for representing the constituent elements of any problem hierarchically (Saaty and Kearns, 1985) and the hierarchical structure will normally have three to four levels. The Level 1 reflects the overall goal or focus of the decision, Level 2 reflects the criteria for the decision, Level 3 contains sub-criteria if any and Level 4 contains the decision choices or alternatives. The proposed framework of this paper involves the following five major steps and these steps are based on Min and Min (1996, 1997), Min et al. (2002), and Chow and Luk (2005):

(1) Decide upon the list of criteria and container carriers for the benchmarking exercise and structure the problem into a hierarchical form.

(2) Make pairwise comparisons among criteria, estimate their relative priorities and check the consistency of pairwise comparison judgments.

(3) Make pairwise comparisons among the container carriers, determine their local priorities and check the consistency of pairwise comparison judgments.

(4) Synthesize the relative priorities of criteria with the local priorities of container carriers to find out the benchmark and conduct sensitivity analysis.

(5) Measure the competitive gaps.

Pairwise comparisons are basic to the AHP methodology. For pairwise comparisons, this paper uses the nine-point scale developed by Saaty (1980) and it is shown in Table 2.

In the above original AHP scale, weak was subsequently changed to moderate and absolute changed to extreme. The intermediate values 2, 4, 6, and 8 are defined as weak or slight, moderate plus, strong plus, and very-very strong, respectively. When activities are very close, a decimal is added to the scale values to show their differences as appropriate, e.g. 1.1, 1.9, 2.1, 2.9, etc. According to Saaty (2008), assigning small decimals is a better alternative way to compare two close activities with other widely contrasting ones, favoring the larger one a little over the smaller one when using the one to nine values. For example, if the service quality of container carrier A is measured as 2.4 over B, this will mean the service quality of A is "moderate plus" slightly or weakly more than B. However, it should be noted that small changes in judgment lead to small changes in the derived priorities (Wilkinson, 1965, as cited in Saaty, 2008). This original AHP scale is used in the present paper because it has been validated for effectiveness, not only in many applications by a number of people,

but also through theoretical comparisons with a large number of other scales (Saaty, 1990). Saaty used a nine-point scale in AHP because he agreed to the findings of Miller, who had reported that there is an

upper limit on our capacity to process information on simultaneously interacting elements with reliable accuracy and with validity and this limit is seven plus or minus two elements (Kannan, 2010).

Table 2. Pairwise comparison scale		
Intensity of importance	Definition	Explanation
1	Equal importance	Two activities contribute equally to the objective
3	Weak importance of one over another	Experience and judgment slightly favor one activity over another
5	Essential or strong importance	Experience and judgment strongly favor one activity over another
7	Very strong or demonstrated importance	An activity is very strongly favored over another. Its dominance is demonstrated in practice
9	Absolute importance	The evidence favoring one activity over another is of the highest possible order of affirmation
2, 4, 6, 8	Intermediate values between adjacent scale values	For use when compromise is needed
Reciprocals of above non-zero numbers	If the activity i has one of the above non-zero numbers assigned to it when compared with activity j, then j has the reciprocal value when compared to i	A reasonable assumption
Source: Saaty (1980)		

2.4. DEMATEL method

The procedures of the DEMATEL method (Fontela & Gabus, 1976) are discussed below.

Step 1: *Generating the direct-relation matrix.*

We use five scales for measuring the relationship among different criteria: 0 (no influence), 1 (very low influence), 2 (low influence), 3 (high influence), and 4 (very high influence). Next, decision makers prepare sets of the pair-wise comparisons in terms of effects and direction between criteria. Then the initial data can be obtained as the direct-relation matrix which is an $n \times n$ matrix T where each element of a_{ij} is denoted as the degree in which the criterion i affects the criterion j .

Step 2: *Normalizing the direct-relation matrix.*

Normalization is performed using the following,

$$K = \frac{1}{\max_{1 \leq i \leq n} \sum_{j=1}^n a_{ij}} \quad i, j = 1, 2, \dots, n \quad (1)$$

$$S = K \cdot T \quad (2)$$

Step 3: *Attaining the total-relation matrix.* The total relation matrix M can be acquired by using Eq. (3), where I is denoted as the identity matrix

$$M = X(I - X)^{-1} \quad (3)$$

Step 4: *Producing a causal diagram.* The sum of rows and the sum of columns are separately denoted as vector D and vector R through Eqs. (4-6). Then, the horizontal axis vector $(D + R)$ named ‘‘Prominence’’

is made by adding D to R , which reveals the relative importance of each criterion. Similarly, the vertical axis $(D - R)$ named ‘‘Relation’’ is made by subtracting R from D , which may divide criteria into a cause and effect groups. Generally, when $(D - R)$ is positive, the criterion belongs to the cause group and when the $(D - R)$ is negative, the criterion represents the effect group. Therefore, the causal diagram can be obtained by mapping the dataset of the $(D + R, D - R)$, providing some insight for making decisions.

$$M = [m_{ij}]_{n \times n}, \quad i, j = 1, 2, \dots, n \quad (4)$$

$$D = \left[\sum_{j=1}^n m_{ij} \right]_{n \times 1} = [t_i]_{n \times 1} \quad (5)$$

$$R = \left[\sum_{i=1}^n m_{ij} \right]_{1 \times n} = [t_j]_{1 \times n} \quad (6)$$

where D and R denote the sum of rows and the sum of columns, respectively. Finally, a causal and effect graph can be acquired by mapping the dataset of $(D + R, D - R)$, where the horizontal axis $(D + R)$ is made by adding D to R , and the vertical axis $(D - R)$ is made by subtracting R from D .

3. Methodology

In this study were used two types of questionnaires, AHP questionnaire and DEMATEL questionnaire. After identified the hierarchical decision tree, In order to gather these data, AHP questionnaire is designed and distributed among 15 experts in Golrang Company. The second questionnaire (DEMATEL questionnaire) contained a table consisting of 16 rows and columns, according to the research questions have been developed. Factors considered in the questionnaire are effective factor on implementation of TQM. We use five scales for measuring the relationship among different criteria: 0 (no influence), 1 (very low influence), 2 (low influence), 3 (high influence), and 4 (very high influence). Next, decision makers prepare sets of the

pair-wise comparisons in terms of effects and direction between criteria.

4. Results and Findings

4.1. AHP Results

Table 3 show rank the Effective Factors in TQM implementation by AHP. Among all the factors in the implementation of quality management systems, management factor with total weight (0.326) is most important and highest rank. Also consider the following factors, factors such as Top management support with total weight (0.114), Training with total weight (0.095), teamwork with total weight (0.086), Employee participation with total weight (0.084), Continuous Improvement with total weight (0.078), Role of the quality department with total weight (0.073), are most important factors.

main criteria	Weight of the main criteria	sub-criteria	Weigh criteria in sub group	total weight	rank
Management factors	0.326	Top management support	0.349	0.114	1
		Supplier quality management	0.102	0.033	14
		Training	0.292	0.095	2
		Employee participation	0.257	0.084	4
Organizational factors	0.224	Organizational performance	0.172	0.038	13
		Planning, policies and strategies	0.314	0.070	7
		teamwork	0.383	0.086	3
		Organizational Structure	0.131	0.030	16
Process factors	0.172	Quality management process	0.186	0.032	15
		Product/service design	0.261	0.045	12
		Customer Satisfaction	0.286	0.050	10
		benchmarking	0.267	0.046	11
Quality factors	0.278	Role of the quality department	0.263	0.073	6
		Continuous Improvement	0.282	0.078	5
		Quality data and reporting	0.218	0.061	9
		Quality Culture	0.237	0.066	8

4.2. DEMATEL Results

Table 4 show Final results of the intensity of effects of Factors by DEMATEL. The results show that the top management support has the greatest impact on other factors. Indeed, among all the factors in the implementation of quality management systems, Top management support is the most influential factor. After this factor, factors such as Quality management process, teamwork and Continuous Improvement Have the highest impact. The results also show that among all the factors in the implementation, factors such as Organizational performance, Supplier quality management, Product/service design and Customer Satisfaction are the most affected.

Table 4: Final results of The intensity of effects of Factors by DEMATEL

Total row (D)		Total column (R)		Total Row and Column (D+R)		Difference of Row and Column (D-R)	
Top management support	5.22	Supplier quality management	4.85	Organizational Structure	9.16	Top management support	1.31
Quality management process	4.93	Organizational performance	4.64	Top management support	9.13	Quality management process	1.24
Continuous Improvement	4.89	Product/service design	4.59	benchmarking	9.06	teamwork	1.12
teamwork	4.88	benchmarking	4.45	Continuous Improvement	9.02	Continuous Improvement	0.76
Role of the quality department	4.85	Customer Satisfaction	4.38	Role of the quality department	8.99	Role of the quality department	0.71
Organizational Structure	4.83	Quality data and reporting	4.37	Quality data and reporting	8.7	Organizational Structure	0.5
benchmarking	4.61	Planning, policies and strategies	4.33	teamwork	8.64	Training	0.21
Training	4.37	Organizational Structure	4.33	Quality management process	8.62	benchmarking	0.16
Quality data and reporting	4.33	Training	4.16	Training	8.53	Employee participation	0.07
Employee participation	4.16	Role of the quality department	4.14	Supplier quality management	8.31	Quality data and reporting	-0.04
Quality Culture	3.77	Continuous Improvement	4.13	Employee participation	8.25	Quality Culture	-0.18
Planning, policies and strategies	3.76	Employee participation	4.09	Planning, policies and strategies	8.09	Planning, policies and strategies	-0.57
Supplier quality management	3.46	Quality Culture	3.95	Product/service design	7.96	Customer Satisfaction	-1.08
Product/service design	3.37	Top management support	3.91	Quality Culture	7.72	Product/service design	-1.22
Customer Satisfaction	3.3	teamwork	3.76	Customer Satisfaction	7.68	Supplier quality management	-1.39
Organizational performance	3.04	Quality management process	3.69	Organizational performance	7.68	Organizational performance	-1.6

5. Conclusion

The purpose of this paper is Identifying and Prioritization Effective Factors in TQM implementation Using AHP and DEMATEL Methods. In this study were used two types of questionnaires, AHP questionnaire and DEMATEL questionnaire. After identified the hierarchical decision tree, In order to gather these data, AHP questionnaire is designed and distributed among 15 experts in Golrang Company. The study result shows that the main factors in TQM implementation are Management factors and quality factors (by AHP approach). The degree of visibility and support that management takes in implementing a total quality environment is critical to the success of TQM implementation. The literature review uncovered four distinctive ways that management can support TQM implementation: allocating budgets and resources; control through visibility; monitoring progress; and planning for change. A company must embrace strong acceptance and maintenance of a total quality measurement and benchmarking plan. Most authors endorse a "zero defect" and a "do it right the first time" attitude towards the quality program. Quality programs should measure the percentage or the number of parts that deviate from the acceptable in order to prevent the recurrence of a defect. Effective factors in TQM implementation are Top management support and

Quality management process (by DEMATEL approach). Ahire et al. (1996) identified, validated, and tested 12 constructs of integrated quality management through an empirical survey of 371 manufacturing firms. Zeitz et al. (1997) developed a survey instrument designed to measure TQM and supporting organizational culture. In this study, 13 priori dimensions of TQM and ten priori dimensions of organizational culture or climate were operationalized in a 113-item survey designed to measure the level of culture and TQM as experienced by individual members. Black and Porter (1996) developed a questionnaire based on a series of items from the Baldrige model and established literature. A 39-items survey was developed and sent to over 200 managers drawn from a target sample of members of the European Foundation for Quality Management. Easton and Jarrell (1998) examined the impact of TQM on the performance of 108 firms that began TQM implementation between 1981 and 1991. They measured the impact of TQM by comparing each firm's performance to a control benchmark. The findings indicate that performance, measured by accounting variables and stock returns, is improved for the firms adopting TQM.

References

1. Ahire, S., Golhar, D. and Waller, M. (1996), "Development and validation of TQM implementation constructs", *Decision Sciences*, Vol. 27 No. 1, pp. 23-56.
2. Bergquist, B., Fredriksson, M. and Svensson, M. (2005), "TQM: terrific quality marvel or tragic quality malpractice?", *The TQM Magazine*, Vol. 17 No. 4, pp. 309-21.
3. Black, S. and Porter, L. (1996), "Identification of the critical factors of TQM", *Decision Sciences*, Vol. 27 No. 1, pp. 1-21.
4. Chang, H.H. (2006), "Development of performance measurement systems in quality management organizations", *The Service Industries Journal*, Vol. 26 No. 7, pp. 765-86.
5. Chow, C.C. and Luk, P. (2005), "A strategic service quality approach using analytic hierarchy process", *Managing Service Quality*, Vol. 15 No. 3, pp. 278-89.
6. Claver, E., Tari, J.J. and Molina, J.F. (2003), "Critical factors and results of quality management: an empirical study", *Total Quality Management and Business Excellence*, Vol. 14 No. 1, pp. 91-118.
7. Dayton, N.A. (2003), "The demise of total quality management", *The TQM Magazine*, Vol. 15 No. 6, pp. 391-6.
8. Easton, G. and Jarrell, S. (1998), "The effects of total quality management on corporate performance: an empirical investigation", *The Journal of Business*, Vol. 71 No. 2, pp. 253-307.
9. Fawcett, S.F. and Magnan, G.M. (2002), "The rhetoric and reality of supply chain integration", *International Journal of Physical Distribution & Logistics Management*, Vol. 32 No. 5, pp. 339-61.
10. Fontela, E., & Gabus, A. (1976). *The DEMATEL observer. DEMATEL 1976 report*. Geneva, Switzerland: Battelle Geneva Research Center.
11. Gotzamani, K.D. and Tsiotras, G.D. (2001), "An empirical study of the ISO 9000 standards' contribution towards total quality management", *International Journal of Operations & Production Management*, Vol. 21 No. 10, pp. 1326-42.
12. Kannan, V. (2010), benchmarking the service quality of ocean container carriers using AHP, *Benchmarking: An International Journal*, Vol. 17 No. 5, pp. 637-656.
13. Legge, K. (1995), *Human Resource Management: Rhetorics and Realities*, Macmillan, Basingstoke.
14. Min, H., Min, H. and Chung, K. (2002), "Dynamic benchmarking of hotel service quality", *Journal of Services Marketing*, Vol. 16 No. 4, pp. 302-21.
15. Min, H., Min, H. and Chung, K. (2002), "Dynamic benchmarking of hotel service quality", *Journal of Services Marketing*, Vol. 16 No. 4, pp. 302-21.
16. Oakland, J., Tanner, S. and Gadd, K. (2002), "Best practice in business excellence", *Total Quality Management and Business Excellence*, Vol. 13 No. 8, pp. 1125-40.
17. Pfau, L.D. (1989), "Total quality management gives companies a way to enhance position in global marketplace", *Industrial Engineering*, Vol. 4, pp. 17-18.
18. Saad, G.H. and Siha, S. (2000), "Managing quality: critical links and a contingency model", *International Journal of Operations & Production Management*, Vol. 20 No. 10, pp. 1146-63.
19. Saaty, T.L. and Kearns, K.P. (1985), *Analytical Planning*, McGraw-Hill, New York, NY.
20. Saaty, T.L. (1980), *The Analytic Hierarchy Process*, McGraw-Hill, New York, NY.
21. Saaty, T.L. (1994a), *Fundamentals of Decision Making*, RWS Publications, Pittsburgh, PA.
22. Saaty, T.L. (2008), "Relative measurement and its generalization in decision making. Why pairwise comparisons are central in mathematics for the measurement of intangible factors. The analytic hierarchy/network process", *RACSAM (Review of the Royal Spanish Academy of Sciences, Series A, Mathematics)*, Vol. 102 No. 2, pp. 251-318.
23. Sinclair, D. and Zairi, M. (1995), "Effective process management through performance measurement: Part I – applications of total quality-based performance measurement", *Business Process Re-engineering & Management Journal*, Vol. 1 No. 1, pp. 75-88.
24. Taveira, A.D., James, C.A., Karsh, B-T. and Sainfort, F. (2003), "Quality management and the work environment: an empirical investigation in a public sector organization", *Applied Ergonomics*, Vol. 34, pp. 281-91.
25. Vargas, L. (1990), "An overview of the analytic hierarchy process and its applications", *European Journal of Operational Research*, Vol. 48, pp. 2-8.
26. Walsh, A., Hughes, H. and Maddox, D.P. (2002), "Total quality management continuous improvement: is the philosophy a reality?", *Journal of European Industrial Training*, Vol. 26 No. 6, pp. 299-307.
27. Zeitz, G., Johannesson, R. and Ritchie, J.E. Jr (1997), "An employee survey measuring total qualitymanagement practices and culture", *Group and Organization Management*, Vol. 22 No. 4, pp. 414-44.

10/22/2012

Mechanism of injury mechanism of boys' amateur epical athletes in Kyokushin ka, Karate and AikidoDr. Mohsen Ghofrani¹, Seyyed Hamed Mousavi²

1. Department of Physical Education and Sport Sciences, University of Sistan and Baluchestan, Zahedan, Iran

2. MA in Sport Pathology and Corrective Exercises

m.ghorani18@yahoo.com

Abstract: The aim of this purpose was to compare injury mechanism in boys' amateur epical athletes in Kyokushin, Karate and Aikido. 95 Aikido athletes, 83 Kyokushin ka athletes, 76 Karate ka were randomly selected from Shiraz clubs. Data were analyzed by X^2 test. The results showed that the rate of injuries in Kyokoshin was (24.1%), Karate (19.5%) ($X^2=448.46$, $P=0.000$). In all three fields, there were injuries in lower limbs more than other organs, but the highest were in Aikido (68.4%). Also, in Karate the technical error of partner, in Aikido the kick of partner and in Kyokoshin, knockdown were recognized as important mechanisms of injuries causes. The rate of incidences of practicing sessions were significantly higher than competition sessions ($X^2=274.1$, $p=0.000$). The results showed that the incident of injuries in Aikido were more than Karate and Kyokoshin. The received results in this research indicated the measure of high prevalence of injury in Aikido to ways of Qukshin and Karate. Aikido is an encounter sport, nevertheless the control ways of Karate were done under the semi – encounter laws and it has been caused the prevalence of fewer injuries in this way. So, the interested persons are recommended to partnership in the control ways of Karate.

[Mohsen Ghofrani, Seyyed Hamed Mousavi. **Mechanism of injury mechanism of boys' amateur epical athletes in Kyokushin ka, Karate and Aikido.** *Life Sci J* 2012;9(4):2593-2597] (ISSN:1097-8135).
<http://www.lifesciencesite.com>. 385

Key words: amateur athletes, Aikido, Karate, Kyokushin ka

1. Introduction

The martial arts have originated from China, Korea and Japan including many different fighting techniques without the use of any weapons. The key benefits of these exercises are self-defense, improving physical fitness, flexibility and self-confidence. Today, East Asian martial arts have been widely expanded among the world's young and adolescents. During these days, martial arts have been increasingly grown largely, so that women apply these exercises for improving their health and defense skills efficiently (2). For example, in European countries, about nine-thousand boys and girls participated in Taekwondo and Karate and twenty-three thousand participated in other martial arts in the Olympic torments and the world championship. The number of children participated in the U.S martial arts matches were about one-million children (18). Also, due to the dramatic movements in martial arts, children are keenly interested in these activities (2), such as Karate, Aikido, Kyokushin ka which have established favorably in Iran. In one hand, the incidence of injuries in martial arts is an inevitable process like other crashing sports and athletes of these exercises are mostly susceptible to risky events. In the other hand, the high number of interested people in these martial arts along with particular rules and techniques have influenced on the number of injuries in this sports but it is not clarified the real differences of these exercises yet. In addition, there have not been carried out any domestic studies in this regard.

Researchers in a review study compared the distribution of the injury in the fields of Kyokushin ka , Aikido and Karate in terms of sex, type, mechanism and the areas of injury; the results of this study showed that generally in martial arts. The rate of injury in girls is lower than boys. Based on injury-based areas, the upper limb in Kyokushin ka, head and face in Karate and lower limbs in Aikido confront with the highest rate of injury; in terms of injury, sprain in kyokoshin ka and Aikido and nose-bleeding in Karate have been reported. Kicking in Kyokushin ka, fisting in Karate and doing cycling kicks in Aikido are mechanisms making the related injuries (8). The other research results in terms of 5 martial arts injuries showed that there is a significant difference between difference martial arts and their type and distribution so that the risky agents in Aikido 59%, Taekwondo 51%, Kong-fu 38%, Karate 30% and Tai-chi 14% were reported. In addition, the risky agent of multi-injuries in Aikido is shown three-fold than Karate. In the field of injury, sprain in Aikido, strain in Taekwondo and Karate, fatigue in Kong-fu and Ti-chi have been known as the greatest injuries in this regard. Based on injury areas, it is obvious that the risky injury of hand and neck, hip, upper and lower limbs were higher in Aikido than Karate (25). German researchers also studied the prevalence of the injury in 15017 martial-workers, 18 year old in 5 martial arts fields. Their results indicated that Taekwondo (36%) in compare to Karate (31%) and Judo (7%) had the highest degree of injury. Also,

95% of these injuries were in moderate level (2). Johnson studied the Karate-ka athletes and their injuries in a research and concluded that the head and neck injuries(51.3%), spinal injuries(23.7%), upper limbs injuries(10.5%), lower limbs injuries(7.9%) and other areas 6.6% were taken place in this regard (12). Boss evaluated 1284 martial arts athletes in 642 tournaments with their movies in a research and the results showed that from these 642 tournaments, 182 cases refer to head injuries, 106 cases about muscular skeleton injuries, 91 subjects in the field of respiratory disorders, 83 cases for minor injuries, 173 matches due to the end of tournaments period and 7 matches were stopped for disqualification; he also concluded that the highest force happening on the head during tournaments is the main reason of these head injuries among athletes (5). The researches carried out in the field of martial arts injuries are at least limited and they have been carried out on few sport fields or the only age variable has been considered as the main parameter of injury areas. The prevalence of fighting injuries in one hand and extra expenses and losing injured athletes forever in the other hand representing the necessity of reducing these injuries as possible; thus the sophisticated analysis of these injuries' type and risky factors in terms of health has been considered as the prevention planning of the injuries. Based on this, we have carried out and compared the most risky agents of Karate, Kyokushin ka and Aikido to show the lowest risk for athletes

2. Material and Methods

The present study was based on a descriptive-comparative and past-view research. The statistical sample of the study including amateur 60 Karate-ka, 68 Kyokushin ka and 90 Aikido athletes between: 14-20 year old, 168+6.3cm, 58.5+7.1 kg from Shiraz clubs. A balanced questionnaire form was applied to collect the related data (Destamb et.al, 2006)(8). This questionnaire was consisted of two parts: the first part relates to players personal background including age, height, weight, dominant position, activity period, practice hours per each session and the second part refers to the prevalence of injury in both practice and competition hours, injury mechanism, injury type and vulnerable areas to injury and the outbreak of injury in dominant and non-dominant positions. It is remarkably noted that the context authenticity of the questionnaire was submitted by 5 professional sport physicists. In order to reach to internal reliability of the questionnaire of 30 athletes in Shiraz city during two-weeks, the related questionnaire was completed by the use of Cronbach alpha coefficient, 86%. In this research, the intensity of the injuries was based on Desemb standard method (2006); due to the athlete's absence for the related injury. These were categorized into 4 groups:

Low (not to have absence and continue activity), moderate (more than one session and lower than 8 days absence from activity), intense (absence from activity 8-30 days) and very intense injury (absence more than 30 days from activity). It must be noted that, the diagnosis of all injuries was submitted by the related physician during tournaments. In addition, only low injuries were recorded during exercises. In descriptive level, the statistical indices including the mean, criteria deviation, distributions and percent were used and inferential level, the comparison of injury prevalence in each field of Aikido, Karate and Kyokushin ka was assessed by K-test efficiently. It should be noted that, due to few cases lower than 5 and impossibility of inferential statistic. Also, Cronbach alpha coefficient was used to determine the internal authenticity of the questions. The low level of alpha ($p < 5\%$) was considered as significant and K-test and Excel for plotting diagrams.

3. Results

Table 1. The number of percent and happened injuries proportion

	Karate		Kyokoshin		Aikido		Total	
	N	%	N	%	N	%	N	%
Injury number	109	14.9	152	20.8	471	64.3	732	100
Injury ratio per 100 people	181.65	19.5	223.5	24.1	523.3	56.3		

The results showed that in general 732 injuries were recorded in three Karate, Kyokushin ka and Aikido. Sport fields; 471 injuries (523.3 injuries in each 100 athletes) in Aikido, 152 injuries (223.5 injuries in each 100 athletes) in Kyokushin and 109 injuries (181.65 injuries in each 100 athlete) were taken place in Karate. The K-test results representing that the degree of happen injuries in Aikido and per 100 people was significantly higher than Karate and Kyokushin ka ($X^2 = 448.46$, $P=0.000$) (table 1)

Table 2. Injured areas of the body

	karate		Aikido		Kyokoshin		Total	
	N	%	N	%	N	%	N	%
Head and neck	29	26.6	25	5.3	31	20.4	85	12
Trunk/bulk	6	5.5	29	6.2	17	11.2	52	7
Upper limbs	28	25.7	95	20.2	50	32.9	173	24
Lower limbs	45	41.3	322	68.4	53	34.9	420	57
Others	1	0.9	0	0	1	0.7	2	0.3
Total	109	100	471	0	152	100	722	100

Table 2 shows the injuries areas in the body. To compare the degree of injury in different areas of the body, other cases were eliminated from the related data. The statistical results indicated that the injuries of lower limbs (41.3%) in Karate, ($X^2=28.5$, $P=0.000$), Kyokushin ka (34.9%), ($X^2=22.7$, $P=0.000$), Aikido(68.4%), ($X^2=498.6$, $P=0.000$) are higher than head and neck and upper limb injuries. These results also showed that lower limbs injuries in Aikido are

higher than Kyokushin ka and Karate($X^2=355.12$, $P=0.000$).

Table 3. Mechanisms of injury

	Aikido		Kyokushin		Karate		Total	
	N	%	N	%	N	%	N	%
Opponent kick	141	29.9	15	9.9	11	10.1	167	22.8
Opponent's tech. Fault	34	7.2	10	6.6	33	30.3	77	10.5
Insufficient warm-up	61	13	10	6.6	3	2.8	74	10.1
Kick into opponent	36	7.6	2	1.3	29	26.6	67	9.2
Lack of physical fitness	48	10.2	8	5.3	5	4.6	61	8.3
Wrong techniques	34	7.2	36	23.7	7	6.4	49	6.7
Hitting on the ground	9	1.9	7	6.4	1	0.9	46	6.3
Getting Feet to feet	23	4.9	8	5.3	8	7.3	39	5.3
Extra pressure	0	0	28	18.4	1	0.9	29	4
Unsuitable surface of the mattress	16	3.4	9	5.9	1	0.9	26	3.6
Previous damage	8	1.7	10	6.6	4	3.7	22	3
Saloon Temp.	16	3.4	0	0	0	0	16	2.2
Extreme tiredness	14	3	0	0	0	0	14	1.9
Others	31	6.6	8	5.3	6	5.5	45	6.1
Total	471	100	152	100	109	100	732	100

In particular, the mechanisms of injuries showed that in general and totally, the opponent kick (22.8%), opponent technical error (10.5%) and the lack of enough warm-up (10.1%) significantly are the highest mechanisms of the injuries ($X^2=377.6$, $P=0.000$). the technical error of opponent in Karate (30.3), hitting on the ground in Kyokushin ka (23.7%) and opponent kick in Aikido (29.9%) are the highest mechanisms making the related injuries (table 3).

Figure 1 shows that there is a significant difference between the prevalence of injury in both exercise and tournament periods.' So, the greatest degree of these injuries relate to practice time (590 injuries); that is, ($X^2=247.1$, $P=0.000$) in Karate; practice time injuries (83 injuries) is higher than tournament time (26 injuries) ($X^2=29.8$, $P=0.000$); in Kyokushin ka also the practice time injuries(115 injuries) are significantly higher than tournament times (37 injuries), ($X^2=40.2$, $P=0.000$), in Aikido also the practice time injuries (392 injuries) significantly are higher than tournament times (79 injuries), ($X^2=208$, $P=0.000$); the results also showed that the practice time injuries in Aikido are significantly higher than Karate and Kyokushin ka ($X^2=293.61$, $P=0.000$). To compare the injury outbreak in dominant and non-dominant positions, the injuries happened in the middle areas of the body were eliminated from the data, and the comparison was carried out based on dominant and non-dominant positions in this regard. The results of K-test showed that the injured degree in dominant area (48.8%) is significantly greater than the lower part ($X^2=16.2$, $P=0.000$). in Karate, there is a significant difference between injured degree in

dominant position (45.9%) and non-dominant position (21.1%), ($X^2=9.98$, $P=0.000$). In Aikido and dominant position (51.4%) the injuries are significantly higher than non-dominant part (39.1%), ($X^2=7.89$, $P=0.005$) while in Kyokushin ka the significant difference between the related areas (42.8% dominant position) and non-dominant part (32.9%) was not found ($X^2=1.95$, $P=0.162$).

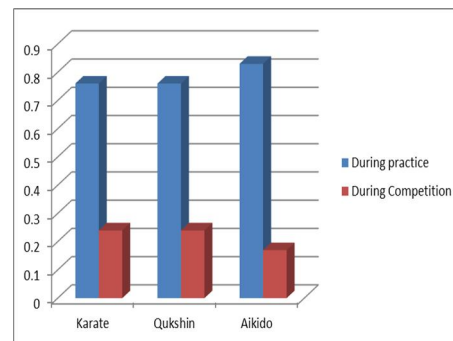

Figure1. The time of injury outbreak

4. Discussions

The main purpose of the research is to study injury mechanisms of boys' epic athletes in Aikido, Karate and Kyokushin. The results of the present study represented that the injuries happened in Aikido is significantly greater than Kyokushin ka and Karate which are matched to German researcher's results (1). As mentioned before, according to another study, the degree of multi-injuries in Aikido is three-fold than Karate style (3). Smith et.al (2009) stated that the vulnerability to any damages relates to the activity of athletes. The results of the study representing that injury in sports like Aikido are in high level. In contrast, controlling kicks make the lowest degree of injury (10). Therefore, the degree of injury in Aikido is higher in compare to Karate and Kyokushin ka. In addition to these rules, the degree of injury in each sport field can be effective; the results of Makan et.al (2006) showed that the importance of new rules in tournaments is one of the reasons of lowest injuries in prevalence and prevention of these injuries (10). Zetarouk et.al (2000) also stated that Karate is being done under semi-fighting rules making the lowest injuries in this field (11). The sport background of each athlete can be effective factor in the prevalence of an injury. The results of the study showed that the risky sports like Karate is significantly increasing with athletes sport background (13, 12).

In the present study, Aikido-ka athletes had the greatest sport background than other athletes which can be one of the reasons of injury prevalence; in this study it is specified that lower limbs injuries in all three fields were the most common injuries and in Aikido it was the highest. In present research it was

reported lower limbs injuries in Aikido, upper limbs in Kyokushin ka, head and face injuries in Karate as the highest injuries among athletes.

Blocked attacks are the most common prevalence of these injuries. We consider these blockage skills as the most important abilities and using protective tools for preventing any damages is an essential parameter in this regard. The way of achieving joint techniques can be effective in the emergence of these injuries in martial arts. We believe that achieving these joint techniques lead to the high degree of muscular-ligament injuries in martial arts. Moreover, the lack of power and balance in the muscles of the body may cause athletes to muscular-skeleton injuries because the lack of power and correct techniques are related together leading to increase the injuries of tendon and ligaments. In addition to these studies, they have been shown that the incidence of the strain with muscular stretches in the lower limbs of Karate-ka can happen due to kicking motions without enough warm-ups. It's suggested that practicing with enough warm-up can prohibit any injuries. The results of the present study showed that the lower limb is significantly known as the most common injury area in the body and Aikido athletes have faced with more lower limbs injuries than Kyokushin ka and Karate athletes. In the recent study, the lower limb in Aikido, upper limbs in Kyokushin ka and head and neck in Karate have been reported as the most well-known areas of injuries. The high usage of feet techniques in Aikido is the high risk factor of injuries. About 80% of these applied techniques in Aikido are kicking by feet. According to this feature of Aikido techniques, it can be studied that due to the high usage of feet, knee to knee kicks and hitting to elbows, the degree of injury in Aikido amateur and professional athletes is happening highly in this regard. Also, in the study it is clarified that the lower limbs is in high-risk area in Kyokushin ka field, will carried out researches, the upper limbs are mostly exposed to the risk areas of injuries in Kyokushin ka. The applied techniques and skills in sport fields can influence on the incidence of the injuries in each sport fields. The studies show that, using move-techniques can be essential factor in the incidence of upper limb injuries in Kyokushin ka. Of course, the high usage of feet can be a good reason for upper limbs injuries in this study. Completing researches in the field of Kyokushin ka used techniques can be impactful to solve this problem. In this study, the lower limbs in Karate were in high-risk area which matched to Destamb and et.al (2006) research (9). The lack of using protective tools such as calf-cover and feet-wear during exercise and tournaments by Karate-ka athletes increase the incidence of injuries. Also, kicking without enough warm-up can cause to muscular injuries in Karate.

Those, using protective tools for feet and warming-up sufficiently can play key role in prevention of lower limbs injuries in Karate. The results of the study representing that technical faults of opponent in Karate, hitting on the ground in Kyokushin ka and opponent kick in Aikido are considered as the mechanisms of injury in this sport field. We consider the greatest injuries in Karate, the opponent technical fault'. The practice of feet and first techniques can reduce the related injuries. Mark et. al (2011) and Arthur et.al (2006) also believe that the accurate judgments and heavy tools can decrease the degree of injuries in Karate (16,17). We consider hitting on the ground due to techniques by male athletes as the most essential factor of injuries in Kyokushin ka and wrong application of these techniques can increase the incidence of these injuries, for Kyokushin ka athletes. The results are matched to other research findings. For getting score in Aikido, the kicks should be down heavily on the opponents. The studies showed that the rapid and heavy feet kicks as un-controlling kicks in Aikido have been down that they can lead to the incidence of injuries of Aikido athletes (7, 22, 23). Anyway, controlling techniques in Karate athletes, correcting Aikido rules and giving precise hitting techniques can be a great background for increasing injuries in Kyokushin ka athletes. Based on the injuries intensity, the greatest degree of injuries relate to low level injuries which is statistically significant Peter(2010) and Halabchi et.al(2007) reported the low level injuries among Karate athletes. The results showed that due to the controlling kicks, the degree of injuries is low and small in Karate (11, 20). According to the results of the present study, we take the lowest risks of injuries among low-experienced and non-professional individuals due to body mass and their low power and ability; we believe that non-professional people are not able to kick heavily like professional ones, so the degree of injury is low. In addition, the results indicated that the greatest degree of injury takes place during practice and tournament times in three Karate, Kyokushin ka and Aikido fields significantly, and the injuries of Aikido is significantly higher than two other ones. The obtained results are matched to the results of Desamb et al. (2006) (9). It is probably the high spending time on practice has been the exact reason for increasing injuries in martial arts. According to the present study, to avoid any injuries among fighters under 18 year old, practicing about three hours per week is reasonable. However, considering accurate practice approaches and using protective wearing can be effective in prevention of any injuries. The results of the present study representing that the percent of dominant position injuries was significantly great in Karate and Aikido but in Kyokushin ka there were no found any

significant differences between dominant and non-dominant parts; but it seems that the incidence of injury in dominant part of body is due to an athlete's skills and abilities; even in the present study clarified that injury in the middle part of body than dominant and non-dominant is a little devoted to itself. This can be due to the natural martial arts because most kicks in Aikido and Karate hit to the lateral lobes than middle areas; also the subject studied that the expanded defensive mood through hands and feet come to the middle part of the body during the opponent attack.

References

- Birrrer, R.B. and Halbrook, S.P. (1988) Martial arts injuries: The results of a five-year national survey. *American journal of sport medicine* 16, 408-410.
- Pieter W. (2005). *Martial arts injuries: Epidemiology of Pediatric Sports Injuries. Individual Sports. Med Sport Sci. Basel, Karger, vol 48, pp 59-73.*
- Ariazza R, Leyes M. (2005) Injury profile in competitive karate: prospective analysis of three consecutive World Karate. Championships. *Knee Surg Sports Traumatol Arthrosc*;13:603-7.
- DeHaven.K and Lintner.D. (1996). Athletic injuries: Comparison by age, sport, and gender, *Am J Sports Med*: 14: 218.
- Zetaruk, M.N, violan MA, Zurakowski, D and michaeli L J. (2005). Injuries in martial arts: a comparison of five styles. *British journal of sport medicine* 39, 29-33.
- Johannsen, H.V. and Noerregaard, F.O. (1988). Prevention of injury in karate. *British journal of sport medicine* 22,113-115.
- Buse G J, (2005): a 10 year review of mixed martial arts competition, *Br J Sports Med* 2006; 40:169-172. Doi: 10.1136/bjism.
- Destombe.C, Lejeune. L, Guillodo.Y.(2006). Incidence and nature of karate injuries. *Joint, Bone, Spine* 73, 182-188.
- Smith MCSP, P. (2009) Aikido Injuries. *Journal of Sports Therapy* 80: 120-125.
- Macan, J., Bundalo-Vrbanac, D. and Romic', G. (2006) Effects of the new karate rules on the incidence and distribution of injuries. *British Journal of Sports Medicine* 40, 326-330.
- Zetaruk MN, Violan MA, Zurakowski D, Micheli LJ (2000). Karate injuries in children and adolescents. *Acc Anal Prev*; 32:421-425.
- Ortu, M., Vaccarezza, M., Trovati, S., Galli, M. and Gervasoni, C. (2006) A martial arts injury: karate induced unilateral haematoma of the adrenal gland. *British Journal of Sports Medicine* 40, 730-731.
- Critchley GR, Mannion S, Meredith C. (1999). Injury rates in shotokan karate. *Br J Sports Med*;33:174-177.
- Buschbacher.R.M, and Shay.T, (1999) Martial arts. *Physical Medicine and Rehabilitation Clinics North America* 10, 35-47.
- Corcoran J, Farkus E. (1999). Aikido In: Corcoran J, Farkus E, Sobel S, eds. *The original martial arts encyclopedia: tradition- history- pioneers.* Los Angeles: Pro-Action Publishing:6-11.
- Finch.C, Valuri.G, Ozanne-Smith.J. (1998). Sport and active recreation injuries in Australia: evidence from emergency department presentations, *Br J Sports Med*; 32:220-225.
- Halabchi F, Ziaee V, Lotfian S. (2007). Injury profile in women Shotokan Karate Championships in Iran (2004-2005). *J Sports Sci Med*; 6:52-57.
- Pieter W. Caine D, Harmer P, Schiff M. (2009). *Epidemiology of Injury in Olympic Sports. International Olympic Committee Encyclopaedia of Sports Medicine.* Oxford: Wiley-Blackwell. 2009; Pp: 249-59.

9/6/2012

A Study of the Relationship between Free Cash Flow and Debt

Peyman Imanzadeh¹, Rademan Malihi Shoja², Akbar Poursaleh³

1. Talesh branch, Islamic Azad University, Talesh, Iran
2. MSc Student in Accounting, Gilan University
3. Khalkhal branch, Islamic Azad University, Khalkhal, Iran

Abstract: The increasing expansion and complexity of economic activities on the one hand and the necessity to provide accurate accounting information on the other underline the necessity of doing research on accounting issues. The results of these studies can serve as a tool for the accounting community for providing transparent information. Financial statements are the best means for providing financial information to users that helps them in making financial decisions. Financial statements must present a record of the financial activities of a business or entity in a structured fashion. Financial statements must include statement of cash flows. Considering the importance of free cash in repaying debts and liabilities, we decided to examine the relationship between free cash flow and debt in the firms listed in Tehran Stock Exchange.

[Peyman Imanzadeh, Rademan Malihi Shoja, Akbar Poursaleh. **A Study of the Relationship between Free Cash Flow and Debt.** *Life Sci J* 2012;9(4):2598-2603] (ISSN:1097-8135). <http://www.lifesciencesite.com>. 386

Keywords: free cash flow, debt, investment opportunities, correlation matrix

1. Introduction

Statement of cash flow is one of the financial reports that are presented to investors. This statement, along with other information in financial statements, can be useful in evaluating debt capacity, liquidity, and financial flexibility. A more complex way of determining the financial flexibility of a business is to analyze its free cash flow. Free cash flow (FCF) is the amount of cash available to a business that can be used in making investments (acquiring other entities or investing in stock exchange), payment of dividend, repaying debts, or increasing liquidity. In other words, this measure reflects the financial flexibility of the company.

Market reaction to debt issues

Chaplinsky and Hansen (1993) carried out a research on market reaction to straight debt issues. They found negative stock returns for up to 140 days before the issue announcement and their findings were consistent with market anticipation hypothesis. Johnson (1995) examined the relationship between leverage, free cash flow, and debt issues for the period 1977-1993. By separating low-dividend-payout and high-dividend-payout firms, Johnson provided evidence that low-dividend-payout firms have significantly positive stock price effects at the announcement of a debt offering. In addition, Jensen (1986) showed that dividends are not necessarily the best tool for obliging managers to pay out future free cash flows, for dividends are paid at the discretion of managers. Jensen argued that there is high agency cost of free cash flow when managers have large cash flows and few investment opportunities.

Howton et al. (1998) measured the market reaction to 937 straight debt issues between 1983 and 1993 with respect to free cash flows and investment opportunities. They argued that leverage-increasing events should increase firm value because of a reduction in agency costs associated with free cash flow. This result is expected in most cases when leverage is increased because debt binds firms to make future cash payouts. Straight debt issues are expected to increase the free cash flow available to a manager of a firm as these issues make additional cash available to managers to be used at their discretion. Howton et al. (1998) found that the market reaction to a straight debt issue is directly related to the issuing firm's level of existing cash and inversely related to the issuing firm's investment opportunities.

Many researchers have used the method of Lehn and Poulsen (1989) for measuring free cash flow. They measure FCF as operating income before depreciation minus taxes, interest expenses, preferred and common dividends, and taxes. Also Tobin's Q is used as a measure for investment opportunities. Tobin's Q is the ratio of the market value of a firm's assets to the book value of the assets. Firms with high Tobin's Q are predicted by market to have more investment opportunities in the future. Thus, firms can be classified as firms with high/low Q and high/low FCF. The median is used for classifying the firms. For instance, firms with high Tobin's Q are those whose Q is higher than the median Q of the sample. In addition to the main variables, several control variables were also examined, including debt to book value of assets ratio, yield to maturity, etc.

They argued that the reason for adding these variables is to calculate cross-sectional differences in debt issues. Researchers collected all the required data from Compustat database and used market model to calculate abnormal return for both sides of debt issues. Abnormal return (AR_{it}) for the firm i on day t is defined as follows:

$$AR_{it} = R_{it} - (\alpha_i + \beta_i R_{mt})$$

where:

R_{it} = return of company i on day t

α_i & β_i = estimates of firm i 's market model parameters

R_{mt} = daily return on the CRSP value-weighted market index over day t

Abnormal return is calculated by using the above equation for a period of 21 days that starts 10 days before the announcement date. The average abnormal returns for all the sample firms (AR_t) is defined as follows:

$$AR_t = \frac{1}{N} \sum_{i=1}^N AR_{it}$$

N denotes the number of sample firms. Mean difference test was used to calculate average abnormal returns during the announcement period and the results related to day 0 for four groups of sample firms are presented below:

Table 1. Group

Group	Mean Abnormal Return	Standard Deviation	t	P-Value
High Q	-0.565	0.024	2.251	0.025
Low Q	-0.239	0.020		
High FCF	-0.410	0.025	0.307	0.759
Low FCF	-0.365	0.020		

Researchers expect that upon debt issue, firms with large free cash flow and few investment opportunities will have lower abnormal returns than similar firms with low free cash flow. Regression analysis is used to examine the relationship between the standardized abnormal return on the announcement day (day 0), proxies of free cash flow, investment opportunities, and several other control variables:

$$SAR_{in} = \beta_0 + \beta_1 Q_i + \beta_2 CF_i + \beta_3 YLD_i + \beta_4 AMT_i + \beta_5 DA_i + \beta_6 QUA_i + \epsilon_i$$

SAR = standardized abnormal return for firm i on day

0

Q = proxy of investment opportunities

CF = cash flow divided by the book value of total assets

YLD = debt yield to maturity

AMT = debt issue in dollars

DA = debt to book value of total assets ratio for firm i

$QUAL$ = quality

$\beta_0 - \beta_6$ = estimated parameters

ϵ = error coefficient

Estimation of this regression model provides insight into the relationship between abnormal return upon debt announcement and free cash flow. Firms with more investment opportunities are probably less faced with the agency problems associated with free cash flow. On the other hand, the stockholders of firms with large free cash flow do not welcome debt announcement which brings excess funds under the control of the management. This suggests that stockholders of such firms react negatively to debt issuance and this leads to the negative response of market to the debt announcement. In general, the researchers found that market response to debt issuance is directly associated with the level of free cash available to a firm and indirectly associated with the debt issuing firm's investment opportunities.

Investment opportunities, debt, and dividend policies

Gul and Kealey (1999) carried out a research to examine the relationship between investment opportunity set, corporate debt, and dividend policies in Korean companies. To analyze investment opportunities, the researchers used the following measures:

$$(1) MBASSET = \frac{ASSETS - BVE + MVE}{ASSETS}$$

$$(2) MBEQUITY = \frac{MVE}{BVE}$$

$$(3) EP = \frac{EPS}{PRICE}$$

where ASSETS is total book value of assets, BE is total book value of common equity, MVE is total market value of common equity, EPS is primary earnings per-share before extraordinary items, and PRICE is closing price of common stocks. Moreover, debt and dividend policies were measured by the following measures:

$$(4) BOOKLEVG = \frac{\text{Total Liabilities}}{\text{Book Value of Equity}}$$

$$(5) MRKTLEVG = \frac{\text{Total Liabilities}}{\text{Market Value of Equity}}$$

$$\text{PAYOUT} = \frac{\text{Dividends per Share}}{\text{Earnings per Share before Extraordinary Items}}$$

(6)

$$(7) \text{ YIELD} = \frac{\text{Dividends per Share}}{\text{Price per Share}}$$

Using factor analysis of the measures 1 to 3, they calculated a common measure that served as a proxy for IOS. In terms of debt policies, firms were ranked as growth or non-growth firms based on top and bottom quartile of the ranked factor analysis, and regression analysis was applied to test the relationship between the variables. This study supported the theory that there is a negative association between investment opportunity set, corporate debt, and dividend policies.

Free cash flow, debt, and audit fees

Gul and Tsui (1998) examined the relationship between free cash flow and audit fees in low growth firms. They divided their sample into firms with high and low debt and used regression analysis to examine the relationship between the variables. The variables of the research were defined as follows:

Growth opportunities: They employed the proxies defined by Chung and Charoenwong (1991), Gaver and Gaver (1993), and Skinner (1993). These proxies are:

- The ratio of the market value of equity to the book value of equity (MKTBKEQ). This proxy is used because the difference between the market value and the book value of equity incorporates the value of the firm's future investment opportunities. The higher the ratio, the greater the value of growth opportunities.
- The ratio of the market value of assets to the book value of assets (MKTBKASS). The higher the ratio, the lower the ratio of assets-in-place to the firm value and the greater the value of growth opportunities.
- The ratio of gross plant, property and equipment to the market value of the firm (PPE).

Lehn and (1989) carried out a research on free cash flow and stockholder gains in going to private transactions. Examining a sample of public firms that were going private between 1980 and 1987, they found evidence in support of Jensen's free cash flow hypothesis and came to the conclusion that:

1. Undistributed cash flow is significantly related to a firm's decision for going private
2. Premiums paid to stockholders are significantly related to undistributed cash flow.

Also Jensen (1986) argued that managers with substantial free cash flow can increase dividends or

repurchase stock and thereby pay out current cash that would otherwise be invested in low-return projects or wasted.

Goyal et al. (2001) examined five widely used proxies for growth opportunities: (1) the ratio of the market value of a firm's assets to the book value of its assets, (2) the ratio of the market value of equity to the book value of equity (MBE), (3) the earnings-to-price ratio (EPR), (4) the ratio of capital expenditures to the book value of assets at yearend (CAPEX), and (5) the ratio of research and development expenditures to the book value of assets at yearend (R&D). They came to the conclusion that MBE has the most important information content as compared to the other proxies.

Methodology

The present research is applied in which two hypotheses are formulated to examine the relationship between free cash flow and debt. The required data was collected from Tehran Stock Exchange (TSE) and DenaSahm Software. Principal component analysis, correlation matrix, and regression analysis were used for hypothesis testing. In the first hypothesis, investment opportunity set (IOS) of firms for a period of five years is described using mean, median, and quartile. Then, correlation matrix and Eigen values are employed to create a common measure that will represent the relationship between the variables. Firms are divided into low growth and high growth firms based on their investment opportunities and considering the research hypothesis, low growth firms are selected. In the second hypothesis, firms are divided into large and small based on firm size variable. Finally in both hypotheses the relationship between free cash flow (FCF) and debt (DE) is examined for the selected firms from the regression model.

Population and sample

The population of the present research consists of all the firms listed in Tehran Stock Exchange (TSE). Based on the financial statement journal published by TSE every three years as well as DenaSahm Software that includes the financial information of the firms listed in TSE, 256 firms form the population of the research. Our aim was to examine all these firms, but the sample firms must have presented their financial statements for the 5-year study period. Thus, the sample is selected as follows:

- A. Firms must have been listed in TSE since 1996 and have provided their financial statements for the period 1996-2000.
- B. The required data that are extracted from financial statements and notes must be complete and accessible.

The sampling thus involves omitting those firms that do not meet these conditions from the sample. In the end, the data on only 86 firms was fully accessible and these firms were selected and studied as the sample.

Investment opportunity set (IOS): IOS is an intangible variable that needs the right proxy for experimental analysis. Sometimes growth is used as a proxy for IOS, but the reliability of this variable is subject to discussion. Nonetheless, we use three widely used measures associated with IOS for examining investment opportunities:

- (1) $MKTBKEQ = \frac{\text{Market Value of Equity}}{\text{Book Value of Equity}}$
- (2) $MKTBKAS = \frac{\text{Market Value of Assets}}{\text{Book Value of Assets}}$
- (3) $EPS/Price = \frac{\text{Earnings per Share}}{\text{Share Price}}$

These measures can reflect the value of future investment opportunities of firms, since the difference between the market and book value of assets and equity as well as earnings and price of each share play a significant role in the future growth of firms.

Market value of assets: This variable is obtained from the sum of market value of equity and book value of debt.

Share price: Share price is the last price of each share at the end of the fiscal year reflected on the exchange bulletin and TSE journals.

Data collection

One of the main variables of the research is FCF and we need depreciation expense in order to calculate it. These expenses are only reported in notes to financial statements. Thus, the notes related to the period 1996-2000 of the sample firms were used for collecting the data related to this variable. Other data such as annual operating income, dividend, earnings per share, share price, book and market value of assets, and book and market value of equity were extracted from financial statements, financial information journal published by TSE, and DenaSahm Software.

Table 2 – Results of analysis of variance

Source of Variance	Sum of Squares	DOF	Mean Squares	F	P
Treatment	SSR	1	$MSR = \frac{SSR}{1}$	MSR/MSE	
Error	SSE	n - 2	$MSE = \frac{SSE}{n-2}$		
Total	SST	n - 1			

Results

Testing the first hypothesis

H1: There is a significant relationship between free cash flow and debt in firms with few investment opportunities.

Investment opportunity set is a variable that depends on several measures and these measures must be analyzed in order to calculate this variable:

1. Market to book value of assets ratio (MKTBKEQ)
2. Market to book value of equity ratio (MKTBKAS)
3. Earnings per share to share price ratio (EPS/Price)

First, using descriptive statistics we calculate the mean, median, maximum, minimum, first quartile, and third quartile of these measures. Then, using principal component analysis and correlation matrix, these measures are incorporated into one common variable (IOS) that serves as a proxy for investment opportunities.

Table 3 – Descriptive statistics of the measures of IOS

Variable	N	Mean	Median	Min	Max	Q1	Q3
MKTBKEQ	86	1.6433	1.4956	0.853	4.7182	1.2814	1.778
MKTBKAS	86	3.2603	2.6126	1.0838	13.4556	1.9932	3.876
EPS/Price	86	0.2658	0.2617	0.102	0.638	0.2236	0.3028

The results of applying correlation matrix in Minitab 11 software are shown in the table below.

Table 4 – Eigenvalues of the correlation matrix

Eigenvalue	1.6643	1.0004	0.3353
Proportion	0.555	0.333	0.112
Cumulative	0.555	0.888	1.000
Variable	PC1	PC2	PC3
MKTBKEQ	0.707	-0.005	-0.707
MKTBKAS	0.706	0.059	-0.706
EPS/Price	-0.038	0.998	0.045

In the first part of the table the eigenvalues of the correlation matrix are obtained and based on principal component analysis, the first component with the highest value is taken as the common factor. The reason for choosing this component is that it accounts for the largest possible variability in the data. Based on the data in Table 4, 55% of the variance of the population is explained by the first component and thus this component is selected as the proxy for investment opportunities. In the second part of the table, the coefficients of MKTBKEQ, MKTBKAS, and EPS/Price (presented in the equation as A, B, and C respectively) are calculated. Since the first component is selected, the IOS equation for each firm can be defined as follows:

$$IOS = 0.707A + 0.706B - 0.038C$$

Using descriptive statistics, the mean, median, first and third quartiles, minimum, and maximum of IOS values are calculated.

Table 5 – Descriptive statistics related to IOS of the firms

Variable	N	Mean	Median	Tr Mean	SD	SE Mean	Min	Max	Q1	Q2
IOS	86	0.000	-0.407	-0.129	1.290	0.139	-1.479	5.978	-0.787	0.396

In this hypothesis, the firms are divided into two groups based on the median IOS. Firms with investment opportunities lower than median IOS are considered low IOS firms and are selected for hypothesis testing. The reason for choosing the median for grouping firms is that, unlike mean, median is not affected by outliers. 43 firms were selected for hypothesis testing and the data is presented in tables below. Table 6 presents the descriptive statistics related to debt and free cash flow of the selected firms.

Table 6 – Descriptive statistics related to DE and FCF of low IOS firms

Variable	N	Mean	Median	Min	Max	Q1	Q3
Debt	43	1.4698	1.1018	0.2638	9.2036	0.701	1.55
FCF	43	0.1034	0.091	0.0082	0.3214	0.0496	0.1186

After selecting the firms with low IOS, the relationship between debt and free cash flow in these firms was examined using a regression model. The results of the regression test for the first hypothesis are presented in Table 7. The regression model is as follows:

$$DE_1 = 0.0847 + 0.0178FCF_1$$

Table 7 – The results of the regression model for the first hypothesis

Predictor	Coefficient	SD	T	P
Constant	0.08471	0.01694	5.00	0.000
FCF1	0.017827	0.008213	2.17	0.036

Notes: S = 0.07787; R² = 10.3%; Adj. R² = 8.1%

Table 8 – Analysis of variance

Source	DF	SS	MS	F	D
Regression	1	0.028567	0.028567	4.71	0.036
Error	42	0.248595	0.006003		
Total	43	0.277163			

For both hypotheses, the error level is considered to be 5% ($\alpha = 0.05$ significance level), that is, 95% confidence interval. Therefore, H1 is rejected if P-value is greater than α and accepted if P-value is less than α . Since the P-value is 3.6% (less than α), the first hypothesis can be accepted at $\alpha = 0.05$. It can thus be concluded that there is a

significant relationship between free cash flow and debt in firms with few investment opportunities at $\alpha = 0.05$.

Testing the second hypothesis

H2: There is a significant relationship between free cash flow and debt in large firms.

First, the firms are divided into small and large firms based on their size (total assets) and then large firms are selected for hypothesis testing. We use median for this classification as well. 43 large firms whose size is greater than the median of the sample are selected for testing the second hypothesis. The descriptive statistics related to this classification are presented in the table below.

Table 9 – The descriptive statistics related to the second hypothesis

Variable	N	Mean	Median	Min	Max	Q1	Q3
FSize	86	33091	112349	3973	102588	4481	2126
Debt	43	1.1056	0.8265	0.2741	3.4232	0.60	1.40
FCF	43	0.0706	0.0694	-0.0078	0.3214	0.02	0.10
						72	5

After selecting large firms, regression model is used for hypothesis testing and the results are presented in Table 10. The regression model is as follows:

$$DE_2 = 0.0457 + 0.0362FCF_2$$

Table 11 – The results of the regression model for the second hypothesis

X

Table 12 – Analysis of variance

Source	DF	SS	MS	F	D
Regression	1	0.030034	0.030034	4.099	0.031
Error	42	0.246617	0.006015		
Total	43	0.276651			

Since the P-value in this hypothesis (3.1%) is less than the significance level (5%), the second hypothesis is accepted and it can be concluded that there is a significant relationship between free cash flow and debt in large firms at $\alpha = 0.05$.

Discussion and Conclusion

The purpose of the present research was to examine the relationship between free cash flow and debt with respect to investment opportunities and firm size. Considering the views of Jensen (1986) that are supported by many researchers (e.g. Jaggi & Gul, 1999; Gul & Kealey, 1999; Gul & Tsui, 1998), high levels of free cash flow are expected in firms with few investment opportunities. Moreover, debt is expected to be high in large firms due to their extensive debt capacity. The present research also

uses this theory and examines the relationship between free cash flow and debt using two hypotheses: (1) there is a significant relationship between free cash flow and debt in firms with few investment opportunities, and (2) there is a significant relationship between free cash flow and debt in large firms. The research covered the period between 1996 and 2000 and the population consisted of the firms listed in TSE. Principal component analysis, correlation matrix, and regression analysis were used for hypothesis testing. The results showed that there is a significant relationship between free cash flow and debt in low IOS firms at $\alpha = 0.05$.

Considering the positive slope of the regression line ($b > 0$), this relationship is positive. It was also shown that there is a significant relationship between free cash flow and debt in large firms. The slope of the regression line is again positive, suggesting the positive relationship between these two variables. In general, the results of the present research are consisted with the findings of Jaggi and Gul (1999) and Gul and Kealey (1999) and support the theory of Jensen (1986).

Firm managers are recommended to analyze investment opportunities before making decisions about distribution of funds as dividend among stockholders and to avoid distribution of free cash in case there are profitable projects for investment. That is because investment in positive net present value projects increases the wealth of stockholders.

References

1. Adam, T., Goyal, V.K., 2000. The investment opportunity set and its proxy variables: Theory and evidence. University of Michigan, Business School.
2. Azar, A., Momeni, M., 1998. Statistics and its application in management. Second edition, SAMT Publications.
3. Einabadi, J., 2002. Liquidity management in large firms. Journal of Accountant, 17(147): 92-95.
4. Fajrak, A., 1996. Intermediate accounting (2). Payame Noor Publications.
5. Forghandoost, K., 1992. Free cash flow statement from the theoretical perspective. Accounting and Auditing Review, 20&21: 34-62.
6. Goyal, V.K., Lehn, K., Racic, S., 2002. Growth opportunities and corporate debt policy: the case of the U.S. defense industry. Journal of Financial Economics, 64(1): 35-59.
7. Gul, F.A., Kealey, B.T., 1999. Chaebol, investment opportunity set and corporate debt and dividend policies of Korean companies. Review of Quantitative Finance and Accounting, 13(4): 401-416.
8. Gul, F.A., Tsui, J.S.L., 1998. A test of the free cash flow and debt monitoring hypotheses: Evidence from audit pricing. Journal of Accounting and Economics, 24(2): 219-237.
9. Howton, S.D., Howton, S.W., Perfect, S.B., 1998. The market reaction to straight debt issues: The effects of free cash flow. Journal of Financial Research, 21(2): 219-228.
10. Jaggi, B., F.A. Gul, 1999. An analysis of joint effects of investment opportunity set, free cash flows, and size of corporate debt policy. Review of Quantitative Finance and Accounting 12, 371-381.
11. Kallapur, S., M. Trombley, 1999. The association between investment opportunity set proxies and realized growth. Journal of Business Finance & Accounting, 26(3-4): 505-519.
12. Mehrani, K., 2001. A framework for analysis of dividend policies. Journal of Accountant, 16(144): 7-10.
13. Mills, J., Bible, L., Mason, R., 2002. Defining free cash flow. The CPA Journal, 72(1): 37-42.
14. Parsayian, A., 1994. Dividend policy, growth, and firm value. Journal of Financial Research.
15. Parsayian, A., Modares, A., 2000. Intermediate accounting. First edition, Farzaneh Publications.
16. Sadeghnia, M., 1997. The relationship between operating cash flow and operating income in stock exchange during the period 1993-1996. Master's Thesis.
17. Sajadinejad, H., 1967. Principles of bookkeeping and accounting. Fifth edition.
18. rivastava, M.S., Carter E.M., 1983. Introduction to applied multivariate statistics. First edition, Elsevier Science Ltd.

9/6/2012

Relationship between organizational structure and knowledge management among staff managers of physical education organization

¹Mahmud Gudarzi, ²Mojtaba Abutorabi, ³Mohsen Ghofrani

1. Associate Prof., Department of Physical Education and Sport Sciences, University of Tehran, Iran.
2. MA in Sport Management, Department of Physical Education and Sport Sciences, University of Tehran, Iran
3. Assistant Prof., Department of Physical Education and Sport Sciences, University of Sistan and Baluchestan, Zadedan, Iran.

Abstract: In order to gain and sustain a competitive advantage in the global economy, today's organizations need to effectively mobilize their knowledge resources. Knowledge management is the organizational optimization of knowledge to achieve enhanced performance through the use of various methods and techniques. The purpose of this study was to determine the relationship between organizational structure and knowledge management among staff managers of physical education organization. The method of this research was descriptive-survey and correlation. First data gathered by field method via censuses of staff managers of physical education organization by two questionnaires. The content validity of these questionnaires was confirmed by officers of management faculty of university of Tehran and their reliabilities were obtained by Krunbakh Alpha again (KM=0.87 and organizational structure=0.82). Finally 38 questionnaires were returned and analyzed (n=38). Results were optioned by SPSS in tow levels of descriptive (internal tendency, variability) and inferential (Spearman and Pearson correlation) Statistics. The significant relationship was showed between formalization with knowledge creation and transfer (p=0.011) (p=0.006) and high level of formalization with down levels of creation and transfer of knowledge were correlated (r=-0.381)(r=-0.241). The relationships between centralization and creation and transfer of knowledge were significant (p=0.012)(p=0.001) and high level of centralization with down levels of creation and transfer of knowledge were correlated (r=-0.421)(r=-0.525). There was no significant relationship between complexity and knowledge creation (p=0.063) but the relationship between complexity and knowledge transfer was significant (p=0.032) that high level of complexity correlated with high level of knowledge transfer (r=-0.229). The relationship between creation and transfer of knowledge was significant (p=0.00) which high levels of those were correlated (r=0.677). With corrective of organizational structure can provide field for application of knowledge management.

[Mahmud Gudarzi, Mojtaba Abutorabi, Mohsen Ghofrani. **Relationship between organizational structure and knowledge management among staff managers of physical education organization.** *Life Sci J* 2012;9(4):2604-2609] (ISSN:1097-8135). <http://www.lifesciencesite.com>. 387

Keywords: Knowledge, Knowledge Management, organizational structure, Staff manager.

1. Introduction

Universalism and competition led to knowledge as a valuable source of strategic and the ability to apply knowledge for marketing opportunities and solve the problem would be its main ability [1]. Management knowledge can be used as a way to improve performance, productivity and competitiveness, improve the efficient acquisition and use of information sharing within the organization, a tool for improved decision making, a way to gain a better method, a way to reduce costs and a late performed research and method for the innovation [2]. Management knowledge is effective in improving quality, increasing efficiency, being up-to-date about information, increasing effectiveness, customer satisfaction and improving decision making [3]. Wiige (2002) believed management knowledge enables any organization improves its usual performance to conscious performance with creativity. Knowledge management aims to discover

new perspectives on learning, knowledge creation and development of inland and offshore competition in the world with a contemporary approach to deliberation staffs, [4]. In early 2000 management knowledges' motto have been raised creation and dissemination and use of knowledge and information of high quality in order to achieve the goals and information with high quality and individual organizational learning. Seely (2003) expressed cycle of knowledge management in the form of four parts:

1. Create, acquire and develop of knowledge,
2. Transfer and apply knowledge
3. Share knowledge
4. Evaluation and store knowledge [3].

Implementing knowledge management in organizations requires the organizational factors, including the structure and culture and technology, human resources and political orientation and with specific characteristics and coherence and necessary coordination. Knowledge creation and knowledge transfer have been considered two main activities in

knowledge management. Creation and knowledge transfer requires a specific structure in Organization. Organizational structure reflects the style and method of individuals and businesses that are arranged in an organization to provide the organizational affairs. Structure is an incentive or barrier of knowledge management. The high recognition in the process, centralizing on decision making, complex relationships are the barriers of generatating the knowledge and new ideas. While the distribution of power and sharing in activities increase knowledge creation and facilitates knowledge transfer in the organization [3].

Asgari (2005) studied the structure and culture, and technology with knowledge management strategy of Labor Ministry and Social Affairs, and concluded although it is a bureaucratic Ministry, reduction of formality and centralization on the organization and increase flexibility and freedom in procedures and decision-making, it can increase and facilitate the creation and transfer of knowledge. Reduction of rules and written procedures of the organization, increasing of non-official relationships and interactions, empowerment of employees about their work, reducing the emphasis on the observance of approved guidelines and procedures, facilitating regular meetings to exchange information between managers and employees, increasing access to information and documents needed for staff can facilitate the creation and transfer of knowledge [3]. Physical education and sport has been considered as the crucial factor of the health and vitality. It has a positive impact on national productivity and prosperity of the country. Investment on products and sport services, on the one hand provides employment and on the other hand, adds to national impure products [5]. With increasing the government emphasis on developing the knowledgeable society and priority to knowledge-based economies in the fifth development plan and the positive effects of this research on improving knowledge management and improving its background, particularly in the areas of sports organization, we intend to study and test relationship between organizational structure (formalization, centralization and complexity) and knowledge management (knowledge creation and knowledge transfer).

2. Material and Methods

This research is a descriptive method-correlation. In terms of classified research, this research also takes place in the category of applied research [6]. The study population consisted of 42 physical education managers organization (physical education coaches and all the managers of the organization in the years 2007-2008, which included

all management positions as directors of the organization were taking the organization had approved the new organization [6]. Data were collected by demographic, Robbins Stephen organizational structure and Asgari knowledge management questionnaires. Demographic questionnaire included questions about demographic and occupational characteristics of individuals such as sex, age, experience, education and employment status. Organizational structure questionnaire, included 24 questions with combination of three separate questionnaires of Stephen. Robbins in central, formality and complexity that was set in a scale of 5, each option "A" 1 point for each question and option "C" is awarded 5 points for each question. Questions 1 to 7 of "A" questionnaire measures the complexity of the physical structure and 8 to 14 questions related to the formalization of organizational structure and organization of physical education and finally, questions 14 and 24 which measure the amount of central on organizational structure of physical education organization.

Knowledge management questionnaire [3], which included 21 questions, was formed of two components of creation and transfer of knowledge. Cronbach's alpha was used to determine the reliability of the questionnaires. Knowledge management and organizational structure questionnaires were calculated 0.82 and 0.87 in order. 94 percent of questionnaires were collected by coordination of national center for research management and sports development. Data were analyzed Pearson correlation. All statistical operations were performed using SPSS software and EXCEL

3. Results

Table 1. Type of education, mean and standard deviation of age and experience of managers

N		Female	Male
		12	26
Experience (SD \pm M)		11.5 \pm 5.45	22.07 \pm 5.30
Age (SD \pm M)		33.5 \pm 3	47.69 \pm 5.49
Educaion degree	BA	9	14
	MA and higher	3	12

38 (12 female, 26 male) directors of physical education organization participated in this study, which demographic variables are shown in Table 1. Results showed that females were with a mean age of 33.5 \pm 3 years and experience of 11.5 \pm 5.451 years and males were with a mean age of 47.69 \pm 5.49 years and experience of 22.07 \pm 5.30 years. Also, the

results showed that 75 percent of females had BA degree and 25 percent had MA and higher degree, while 8.53 percent of males had BA degree and 2.46 percent had MA and higher degree.

Table 2. Relationship between formalization, central and complexity of organization knowledge creation and knowledge transfer

Predictable index		Correlation coefficient	P
formalization	knowledge creation	-0.241	0.11
	knowledge transfer	-0.381	0.006
central	knowledge creation	-0.421	0.12
	knowledge transfer	0.525	0.001
complexity	knowledge creation	-0.119	0.063
	knowledge transfer	-0.229	0.032
knowledge creation	knowledge transfer	0.677	0.000

There is a significant inverse correlation between formalization and knowledge creation ($p = 0.11$, $r = -0.241$), that is, high level of formalization is correlated with low levels of knowledge creation and vice versa.

The correlation of -0.381 indicates a significant inverse between formalization and transfer of knowledge ($p = 0.006$). It means that the high level of formalization is correlated with low levels of knowledge transfer and vice versa. There is a significant relationship between centralizing on creating and transferring knowledge in physical education organization. So the correlation value ($p = 0.012$ and $r = -0.421$) indicates an inverse relationship between concentration and knowledge creation and correlation value ($p = 0.001$ and $r = 0.525$) indicates an inverse relationship between concentration and transfer of knowledge. That means high level of concentration is correlated with low levels of knowledge creation and transfer, and vice versa.

There was not significant relationship between complexity and knowledge creation of physical education staff managers ($p = 0.063$, $r = -0.119$). There was an inverse relationship between complexity and knowledge creation of physical education staff managers ($p = 0.032$, and $r = -0.229$). That means high level of complexity is correlated with low levels of knowledge transfer and vice versa. As Table 2 shows, there was a positive and significant relationship between creation and knowledge transfer of physical education staff managers ($p = 0.000$ and $r = 0.677$).

4. Discussions

Descriptive results showed 68.4 percent of the total sample was males and 31.6 percent was women in physical education organization. According to the results, In order to achieve a more balanced position in this regard, physical education organization should consider necessary arrangements to the growth and promotion of exercise among women in society.

It was also found that the mean and standard deviation of age among staff managers was 40.59 ± 2.4 years old. Managers of organizations should be experienced enough and it appears in physical education organization status is relatively favorable. But in order to increase new information and attention to knowledge management and environmental changes, they can use younger consultants in this field. According to the data, job experiences among men were more than men. The result of education status showed 23 individuals (64.4 percent) had BA degree and 15 (35.6 percent) had MA and higher degree. According to the results, managers' education in educational status was relatively favorable. Results showed that 29 percent of managers graduated in physical education, 34.2 percent graduated in management and 36.8 percent graduated in other fields. The status of education among managers was not desirable, so the highest frequency was related to other fields, which shows there was not good balance between work and field of education.

There was an inverse and significant relationship between formalization and knowledge transfer in physical education managers. It can be said by increasing instructions, circulars, laws and regulations in physical education organization, elements of knowledge management were placed in the lower level and reduce instructions, circulars, laws and regulations in the organization to create knowledge creation and knowledge transfer (until organization is not out of its goal and its mission would not be ruined) and provided the background for the successful implementation of management knowledge. Some research have also confirmed these findings. Davoodi (2001) and Nazari (2005) concluded there is a significant relationship between formalization and cooperative management, speed decision making and creativity [7, 8]. Omidi (2006) and Khalifa (2007) found that there is an inverse significant correlation between formalization and physical education organization managers' creativity [9, 10]. Lipotz and colleagues (2000) found public organizations are hierarchical and bureaucratic organizations typically make difficult knowledge sharing [6].

They say that most people have no desire to share this knowledge with others. They hold knowledge in their hearts to gain the power that it can raise to their rank [11]. Hunter (2002) concluded that less organizational hierarchy and more vertical and horizontal communication between the staffs of an organization, provide more adequate space for planning of an entrepreneurship [12]. This orientation can be due to the implementation of knowledge management. Specific structure and later formal structure of guidelines, circulars, rules and regulations become less (until organization is not out of its goal and its mission would not be ruined) and managers can easily share information together from cumbersome rules in an informal atmosphere, and provide context for the successful implementation of knowledge management. There was an inverse relationship between concentration and knowledge creation, it means that high level of concentration is correlated with low levels of knowledge creation and vice versa. It can be said with the increasing adoption of decisions on a particular point in the physical education organization, knowledge management components are placed in a low-level and to create staff managers knowledge and knowledge transfer between organizations can reduce the focus on single decision making (until organization is not out of its goal and its mission would not be ruined) and provided the background for the successful implementation of knowledge management. Davoodi (2001), Nazari (2005), Omid (2006) and Khalifa (2007) concluded there is a significant relationship between lack of centralization and cooperative management, speed decision making and information flow, entrepreneurship, creativity and productivity of staff managers [7, 8]. Bozbura (2007) has diagnosed suitable decentralized structure in creating an environment where employees can create a spontaneous process of knowledge [13]. Group decision-making is the participants elements of organizational knowledge and knowledge compatible activities which Kamimada and colleagues (2007) have referred to it [15].

This orientation can be due to the implementation of knowledge management requires a specific structure. Structure and centralization in which decisions have not been prevented as possible as at a certain point (until organization is not out of its goal and its mission would not be ruined) and managers in a full of confidence atmosphere, shared with knowledge and information and with participation in decision-making provide the background for the successful implementation of knowledge management. However, this partnership would guarantee the further organizational goals and strategic management of knowledge.

There was no significant relationship between complexity and organization of physical education staff managers, it can be said that separate organizational units, organizational segmentation, increasing the number of management levels and staff managers of geographical knowledge do not create any relationship with knowledge creation of staff managers.

This finding is parallel with Khalifa (2007), who could not find a significant relationship between complexity and entrepreneurship, could be due to use of equal tools to measure complexity, and sample of two studies [10]. The finding was inconsistent with the results of complexity of organizational knowledge management. This inconsistency would be due to low volume of samples compared to other studies. Hemmati Nejad (1996) found the average point of organizational complexity structure in physical education organization is in middle level, this can be one of the reasons for the lack of effect of these variables on the staff managers' knowledge creation of that organization [16].

There was an inverse and meaningful relationship between complexity and knowledge transfer of staff managers in physical education organization. It can be said that separate organizational units, organizational segmentation, increasing the number of management levels and staff managers of geographical knowledge keep knowledge transfer in low level and for the successful implementation of knowledge management can decrease separate organizational units, organizational segmentation, the number of management levels and geographic distribution.

Khalifa (2007) and Salavati (1999) concluded that there is negative and strong relationship between organizational complexity, creativity and entrepreneurship, [10, 17]. Hunter (2002) showed organizations with low complicated have more cooperation between organizational units and significantly increased the percentage of corporate entrepreneurship [12]. Ruikar and colleagues (2005) expressed that the horizontal organizations are more suitable for knowledge and information ages, and have more flexibility in environments with rapidly changing and competitive business [19]. This orientation can be due to the particular structure of knowledge management implementation demands. Structure and complexity in which there are separate organizational units, segmentation organization, increasing the number of management levels and geographic distribution should be prevented as possible as (until organization is not out of its goal and its mission would not be ruined) and managers share the knowledge in environment by facilitating relationships (low

complexity) and close communication and provide background for the implementation process of knowledge management (creation and transfer and sharing) and to successful implementation of this concept.

There was a positive and significant relationship between creation and knowledge transfer of staff managers in physical education organization, so that the two were correlated with each other in high level. So with the help of each component, can provide the successful implementation field for the other components of knowledge management. In other words, according to the correlation of knowledge management process to each other, It can be considered as a system (knowledge management process) that components levels interconnected to each other.

Adli (2007) by providing a model of creating and sharing knowledge in organizations stated that the organization ability for knowledge creation and sharing of knowledge includes the ability to gain information and knowledge, foundation of knowledge, absorptive capacity, learning, learning relaxation, care, cooperation, networking, coalition, combination, innovation, design and problem solving (the process of knowledge management) [1].

Giesler (2007) identified four stages of knowledge management typology: transmission, absorption and deployment (knowledge management) and three types of knowledge transfer i.e. manufacturers, transferes and users [19]. Heinrichs and Lim (2005), Xiogiannis and colleagues (2004) offered the production knowledge, including: implementation of knowledge production, visible and showing them, treatment and follow up the encoded contents to the audience found it out of the state code, transle and understand [20, 21]. This step (knowledge production) is a model similar to the Holsapple and John (2005), and Kankahalli (2004) presented in which knowledge is translated into a form that can be transferred to others. Knowledge transfer is a partial step which users translate knowledge, share and distribute [22, 23]. This orientation can be consistent with the stated problem Ehsan and Rowland (2004) have stated this case involves the implementation of knowledge management in organizations, that the organizational factors (structure, culture, technology, human resources, political orientation, etc.) Own the specific characteristics and coherence and coordination [3]. These factors and organizational components have been expressed necessary and interdependent in most of the time that can be looked at it as a whole in the organization

References

1. Adli, F. 2005. Movement knowledge management toward moving beyond knowledge. Farashenakhti Andisheh Pub, Tehran.
2. Asgari, N. 2005. The relationship between organizational factors (structure, culture, technology), of Ministry of Labour and Social Affairs with a knowledge management strategy, MSc thesis, Faculty of Management, Tehran University.
3. Syed-Ikhsan, S.O.S., Fytton, R. 2004. Knowledge management in a public organization: a study on the relationship between organizational elements and the performance of knowledge transfer Journal: Journal of Knowledge Management. 8, 2: 95 - 111.
4. Wiig, K.M. 2002. Knowledge management in public administration, Journal of Knowledge management, 6(3): 224-390.
5. Physical Education organization. 2004. Detailed documentation of a comprehensive system of physical education and sport (financial resources), Tehran, Sibe Sabz pub.
6. Sarmad, Z., Bazorgan, A., Hejazi, E. 1998. Research methods in behavioral science, Agah pub., Tehran.
7. Davoodi, B. 2001. Football federation of organizational structure and providing the optimal pattern. MA thesis, Tehran University.
8. Nazari, H. 2005. Relationship between participatory management structure in Fars group, MA thesis, Tehran University.
9. Omidi, A. 2006. Relationship between organizational structure and management of organizational creativity of Physical Education Organization, MS Thesis, Tehran University.
10. Khalifeh, M. 2007. Relationship between organizational structure and organizational Entrepreneurship staff managers of Physical Education, MS Thesis, Payam Noor University.
11. Liebowitz, J., Ayyavoo, N., Nguyen, H., Carran, D. Simien, J. 2007. Cross generational knowledge flows in edge organizations. Industrial Management and Data Systems, 107, 8 1123-1153.
12. Hunter, J.D. 2002. Improving organizational performance through the use of effective elements of organizational. 15:12-21.
13. Khalati, F. 1998. Evaluation of centralization and decentralization in decision-making structure and its effect on Productivity and Performance Management of Ministry of Construction, MS Thesis, Tehran University.
14. Bozbura F.T. 2007. Knowledge management practices in turkiss SME. Journal of interprise information management. 20, 2, 209-221.

15. Kamimaeda, N., Izumi, N., Hasida, K. 2007. Evaluation of participants' contributions in knowledge creation based on semantic authoring, *The Learning Organization*. 14, 3, 263-280, Emerald Group Publishing Limited www.emeraldinsight.com/0969-6474.htm.
16. Hemati nezhad, M.A. 1996. Comparison of Structure of Physical Education Organization of Iran and several countries to determine the appropriate decision.
17. Salavati, A. 1999. Investigation and analysis on the effects of organizational behavior, organizational creativity and innovation in public organizations in Kurdistan province, MSc thesis, University of Allameh Tabatabai.
18. Ruikar, K. Anumba.G.J, Carrillo.P.M. 2005. An-readiness assessment application for construction companies. *Automation in construction* Article in press.
19. Giesler, E. 2007. A typology of knowledge management: strategic groups and role behavior in organizations *Journal of Knowledge Management*. 11, 2, 84-98.
20. Heinrichs, J. and Lim, J. 2005. Model for organizational knowledge creation and strategic use of information, *Journal of the American Society for Information Science and Technology*, 56, 620-31.
21. Xiogiannis, G. Glykas, M. and Staikouras, C. 2004. Fuzzy cognitive maps as a back end to knowledge-based systems in geographically dispersed financial organizations', *Knowledge and Process Management*, 11, 2, 137-54.
22. Holsapple, C. and Jones, K. 2005. Exploring secondary activities of the knowledge chain, *Knowledge and Process Management*, 12, 1, 3-31.
- Kankanhalli, A. and Tan, B. 2004. A review of metrics for knowledge management systems and knowledge management initiatives, in Sprague, R.H. Jr (Ed.), *Proceedings of the 37th Hawaii International Conference on Systems Science*, Big Island, HI, January, IEEE, Los Alamitos, CA..

9/6/2012

Studying the effect of 8 weeks corrective exercise program on student's scoliosis changes.¹Farhad Kouhi Achachlouei, ²Mehdi Abbaszadegan, ³Sakene Aminnjad, ⁴Mohammad Nasiri^{1,2}Department of Physical Education, Maku Branch, Islamic Azad University, Maku, Iran³Maku Education Department, Iran⁴Department of Physical Education, Central Tehran Branch, Islamic Azad University, Tehran, Iran

farhad.kouhi@yahoo.co

Abstract: Present research studies the effect of 8 weeks corrective exercise program on student's scoliosis changes in primary school. 330 students screened randomly using New York test. Among them, 48 students had scoliosis deformity with different intensities. Then, Adams test delineated that among them 41 students were type II scoliosis (functional). Among students with functional scoliosis, 20 and 23 students selected to control and experiment groups respectively, and experiment group participated in a corrective exercise program for 8 weeks, 3 sessions per week. Results from post-test analyzed by using T-student test at 95% confidence level. Results showed that there are significant relationship between scoliosis intensity of experiment and control groups, and rate of scoliosis outbreak and students age ($P \leq 0/05$).

[Farhad Kouhi Achachlouei, Mehdi Abbaszadegan, Sakene Aminnjad, Mohammad Nasiri. **Studying the effect of 8 weeks corrective exercise program on student's scoliosis changes.** *Life Sci J* 2012;9(4):2610-2612] (ISSN:1097-8135). <http://www.lifesciencesite.com>. 388

Key words: scoliosis, students, corrective exercise program.

1. Introduction

Children and adolescents expose to postural deformity of spine due to being in sensitive position of growth and having special properties of body. Spine is an important part of body and form central axis of body which includes numbers of bone called vertebra that connect together by number of cartilage-fibrosis tissue called disk. Spine forms from four arcs. These arcs decrease vertical pressure from force of body weight, this force is tenfold more than status without arcs (1, 13). When study spine from backward view, spines should be in one direction and without minor slip to sides. Any case of vertebra dislocation from its natural position to sides titled deformity, and this deformity called scoliosis in today sciences, it has different types and is made for a variety of reasons. Type I is diversion that is created due to structural changes in spine and type II is diversion that created due to weakness of conservator muscles, these arcs form because of mistake position in sitting, standing, sleeping and carrying things. According to studies, type II scoliosis showed more corrigibility to corrective exercise program, so that it is called functional or moving scoliosis (1, 4, 5, and 8). Scoliosis usually appears before 14 age and two third of it is postural scoliosis and its outbreak rate in adolescence age is more in girls than boys (1, 13). Ellapen et al (2011) identified 70/44% and 73/94% incidence of scoliosis among the male and female students respectively ($P < 0/05$) in the frontal plane (7). Zhang Shou et al (2003) showed that 17 students were definitely diagnosed to have scoliosis, with a prevalence of 20% in males and 21% in females. They

concluded that the investigation of scoliosis among school-age population is of great importance for early diagnosis and effective prevention and treatment of scoliosis (15). Ghanbarzade (2002) and Yazdanifar (1995) reported the outbreak rate of scoliosis in students 12/1% and 16% respectively. In all studies, based to kind and intensity of scoliosis deformity, different methods have been recommended for correction and treatment of scoliosis and the most specialists recommend surgical operation for correction and treatment of structural scoliosis with high intensity. But using appropriate corrective exercise and comprehensive and lasting program can treat type II scoliosis by strengthening the weak muscles and stretching shortened muscles and cause increased muscular endurance and improvement of spine mobility (3, 6 and 14). Since in every design, planning and organizing is based on scientific studies and using true planning can gait important steps in diagnose, prevent and correction of skeletal deformity and impart the society of having health and dynamic generation (11). Here of the present study want to investigate initially the outbreak rate of scoliosis deformity in students and then using a corrective exercise program, it investigates the effect of this program on decreasing scoliosis deformity intensity.

2. Material and Methods

Using Newyork test, 330 boy students in 8-11 years at primary school, were screened. 48 students have scoliosis deformity with different intensity. Then using Adams test, students with type II scoliosis (functional) determined, number of them were 41 students. Among functional students, 18 students with

average age of 10/14±1/04 years, average scoliosis intensity of 9/23±1/4 in Newyork test scale for control group, and 23 students with average age of 9/63±1/21 and average scoliosis intensity of 9/07±1/61 for experiment group were selected. Then a period of corrective exercise program performed on experimental group for 8 weeks, 3 sessions per week, and 30 minutes per session.

For evaluating and gaining research data used tools such as chess plane and Newyork test. Subjects stood backward in front of chess plane, so plumb line passed on spine and leg middle and divided body into equal parts. Subjects were asked to stand in front of chess plane without minor muscle contraction. Subjects were evaluated from back at 6 m distance (1, 13).

Because of doing pilot study and work background of researcher with measuring tools and also evaluating a deformity alone, screening performed in short time. For gaining statistical data to concluding, observed positions in the screen phase by Newyork test called as good (5 score), moderate (3 score) and weak (1 score) positions. Then every one of above positions graded as good from 10-12, moderate from 7-9 and weak from 4-6 (3).

In pretest phase for evaluating flexibility of spine muscle, subjects stood normally and distance between middle finger to land was measured by tape line in convexity side. Then same distance was measured in lateral flexion position in convexity side. Then data from measurements minus from each other and result considered as flexibility of spine muscle in concavity side shortened muscle (2). In post-test and in end of corrective exercise program, subjects of two groups were evaluated as former method and gained data analyzed by χ^2 and T-student test ($P \leq 0/05$).

3. Results

1- From 330 screened students using Newyork test with average age of 09/71, 48 (14/5%) had scoliosis with different intensities. Distribution rate of all subjects have presented at age and outbreak rate of scoliosis in table

2- Rate of scoliosis intensity in different ages estimated by using Newyork test 4/06% in 8 years, 4/31% in 9 years, 4/53% in 10 years and 5/03% in 11 years (graph 1).

3- Scoliosis intensity compared between ages of 8-9 and 10-11 using independent T-student test ($P \leq 0/05$), so that there was no significant difference between scoliosis intensity between age of 8-9 and 10-11 (hypothesis 1)(table 2).

4- Using independent T-student test ($P \leq 0/05$), corrective exercise program had significant effect on scoliosis treatment (hypothesis 2) (table 2).

5- Evaluating flexibility of subject's spine muscles in pre and post test using dependent T-test and

comparison of results from two tests efficacy of corrective exercise program for scoliosis treatment confirmed (hypothesis 3)(table 2).

Table 1. Distribution rate of the subjects at age and scoliosis outbreak

Age	8	9	10	11	Total
Distribution rate of the subjects	52	89	109	80	330
Subjects distribution percentage	15/7	26/9	33/03	24/2	100
Outbreak rate of scoliosis	8	10	18	12	48
Outbreak percentage of scoliosis	2/4	3/03	5/4	3/6	14/5

Table 2. Hypothesis results

Hypothesis results	N	d.f	t_{obs} χ^2_{obs}	t_{cri} χ^2_{cri}	Sig. $P < 0/05$
Hypo 1	48	46	2/43	2/02	*
Hypo 2	20	19	5/16	2/09	*
Hypo 3	20	1	7/23	2/09	*

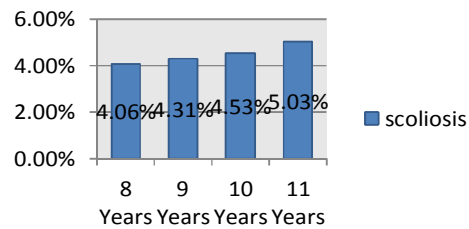

Graph 1- rate of scoliosis intensity in subjects.

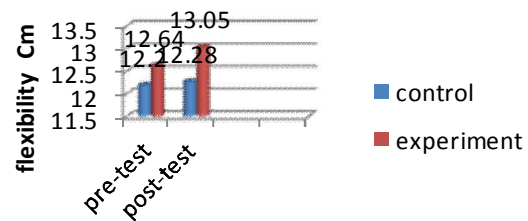

Graph 2- flexibility in experimental and control groups spine in two phases.

4. Discussion and Conclusion

The present study investigated not only the effect of a corrective exercise program on scoliosis in 8-11 years primary school students, but also rate and intensity of scoliosis outbreak. For evaluating postural and scoliosis intensity in subjects, Newyork test and chess plane were used. Results from statistical analysis of this research studied and compared with other studies. Because in majority of studies related to

scoliosis have been used Newyork test and chess plane, and comprehensive view to special properties of every one of these studies show that although these tools are not an exact scale, but provided true use and enough experience of the tester, they can have relatively high reliability. However, for assuring of validity and reliability of used tools, after selecting sample for experiment group, researcher selected randomly 7 students among experiment group and after receiving testimonial from parents 3 of 7 students went to radiography and confirming by specialist physician; the result showed that there was scoliosis in 3 students with different grades. But in post test, subjects did not tend to radiography again.

Roberts et al (1988) performed a 10 weak training program on 120 patients with pain in back because of spine postural deformity such as scoliosis. After 10 weeks; they observed significant difference in physical abilities, mobility and efficacy (6). Daneshmandi et al (2003) performed a corrective exercise program for 8 week, 3 session/week on 20 students with scoliosis deformity, and observed that present corrective exercise had significant effect on scoliosis changes. Flexibility of spine muscles also had increased after training program. Rahnema et al (2009) studied the effect of 8 week regular corrective exercise on spine status (kyphosis, scoliosis and lumbar lordosis) of girls students, results show that rate of kyphosis and scoliosis in girls decreased significantly after training program, that is consonant to result of present study (12). Nisainen et al (1989) performed study on scoliosis and asymmetry trunk measurement in students. They screened 1060 students with average age of 8-10 years using chess plane and Network test, outbreak rate of scoliosis was 4/1%, this is consonant to present study results. Roberts (1993) performed study titled trunk symmetry, postural, growth and scoliosis danger on 896 students in age of 10/8-13/8 without scoliosis before. He evaluated them year by year and observed that during first 3 years, 24 boys and 41 girls had scoliosis deformity. In this study he studied outbreak rate and increased risk existing scoliosis with increasing age in two genders (9). Lasjuri et al (2005) in study titled study and recognition of 11-13 boy students deformity and its relationship with age, weight and height; reported outbreak rate of scoliosis 7/5% (10). Vaseghi (2005) reported outbreak rate of scoliosis 15/23% in his study that showed corrective exercise had significant effect on corrective exercise, and regarding to increased scoliosis outbreak and training effectiveness, it agree with the results of this study (14). It is probably that differences in scoliosis outbreak rate in existing studies related to variety in number of statistical population.

Regarding to already study results and also result of the present study can conclude that using

stretching and strength exercises effect on scoliosis deformity treatment. On the other hand, regarding to outbreak rate of scoliosis and effectiveness of this deformity on other physical factors of person with scoliosis, serious attention to this problem and the effect of corrective exercise in preventing and treating this deformity especially among students is distinctive. Also special attention to problem by physical education teachers who dealing with students physical status can play an important role in identifying and correcting of deformity by coordination with students parents.

References

- 1-Alizade MH, Gharakhanlu R and Daishmandi H, Therapeutic and corrective exercise, Jahad-Daneshgahi publication, 2002.
- 2-Bunch, Wiltpn H. patwardhan, Avinash. Scoliosis making clinical Decisions. 1989.
- 3- Bloom field, J. Ackland t T.R., and Elliott, B.C. Applied Anatomy and Biomechanics. Oxford Black well scientific publications, 1995.
- 4-Barfi Mogadam J, survey the status of spine deformity among Tabriz bpy high school students, master thesis, Islamic Azad university Tehran unit, 1995.
- 5-Din MRI, Basic Anatomy and Physiology for physicians, Translated by Hamid Reza Tahmasebpour, Nasher center publication, 1994.
- 6-Daneshmandi H, and et al, survey of scoliosis changes after a period of corrective exercise training, scientific-Research journal of PE, Tehran University, 2004.
- 7-Ellapen TJ, Heerden HJ van. Musculoskeletal posture profile analyses of university of Kwa-Zulu natal students in South Africa, African Journal for Physical, Health Education, Recreation and Dance, vol 17.No 4, 2011.
- 8-Honary H, survey and recognition of postural deformity of athletic bod student in all over the coutry, Mater thesis, Tarbiat Modares university, 1992.
- 9-Karimi M, survey of relationship between prevalence rate of upper body postural deformity and anti-gravity muscles in boy guidance school, Master thesis, Tarbiat Modares University, 2001.
- 10-Lasjuri GH, et al, survey and recognition of 11-13 years boy student deformity and its relationship with age, weight and height. Research journal in sport sciences, 2007.
- 11-Nirpour M, survey of prevalence rate of spine and lower body postural diversions in 11-15 girl students and its relationship with some of inviroment factors and body types and presenting corrective exercise, master thesis, 1995.
- 12-Rahnema N. et al, Effect of &week's regular corrective exercise on spine posture kyphosis, scoliosis and lumbar lordosis in girl student. Esfahan phtsician journal, 2009.
- 13-Sokhanguee Y, Gorrective Exercise, Boy Physical education department of Education ministry, 2000.
- 14-Vosegi N, survey rate of upper and lower body deformities and relationship of some variables with each other and body types in 7-11 years girl students and presenting corrective exercise. Master thesis, 1995.
- 15-Zhang shou, JIN Xuhong, GUO Xian, et al. A survey on scoliosis in school-age population in Hainan. Hainan Medical Journal vol 12, 2003.

9/6/2012

The Effect of Coach Stability on the Performance of Football Teams in Iran Pro League

Farideh Hadavi¹, Mohammad Soltani², Lila Sabbaghian Rad³, Khalil Alavi⁴

1. Department of Physical Education and Sports Sciences, Eslamshahr Branch, Islamic Azad University, Tehran, Iran
2. Tehran Province Sport & Adolescent Org, Tehran- Iran
3. Department of Physical Education and Sports Sciences, Science and Research Branch, Islamic Azad University, Tehran, Iran
4. Department of Physical Education and Sports Sciences, University of Qom, Qom, Iran

Abstract: The purpose of the present research was to examine the effect of coach stability on the performance of the football teams in Iran Pro League (IPL). The population of the research consisted of 18 football teams in the 2009-2010 season of IPL and the required data was collected from archival documents of the league department of Iran's Football Federation. The difference in the performance of teams with and without coach stability was analyzed using Mann-Whitney U test. Performance was examined with respect to eight measures: points, rank, wins, draws, losses, goals for, goals against, goal difference, and coach stability (i.e. whether or not the coach has been fired during the studied season). From the 18 studied teams, 33.33% had coach stability, while 66.67% of the teams had changed their coaches at least once during the season. The mean coaching life in the studied season is 16.1 weeks. Coach stability has been effective for the performance of teams in terms of points ($z=-2.29$, $p=0.022$), rank ($z=-2.34$, $p=0.019$), wins ($z=-2.13$, $p=0.033$), draws ($z=-54.2$, $p=0.011$), and goal difference ($z=-1.96$, $p=0.049$). The findings of the research show that instability and coach turnover is a common issue in IPL. Although managers change the coach in order to get better results, the results of the research suggest the ineffectiveness of this strategy.

[Farideh Hadavi, Mohammad Soltani, Lila Sabbaghian Rad Khalil Alavi. **The Effect of Coach Stability on the Performance of Football Teams in Iran Pro League.** *Life Sci J* 2012;9(4):2613-2616] (ISSN:1097-8135). <http://www.lifesciencesite.com>. 389

Keywords: Iran Pro League, performance, football teams, coach stability

1. Introduction

Organizations change their management in order to improve performance. The effect of these changes on performance is an important issue in the area of sports and has remained a question in organizational sociology and sport management after three decades of experimental research (1, 2, & 3). The coach is an essential element in the management of football teams, for they make certain administrative and strategic decisions that affect team performance (4, 5, 6, 7, 8). Coaches train players, motivate them, select them for different matches, and make decisions regarding tactics and strategies (9 & 10). If the coach fails to meet the expectations, they may be fired or transferred. Nonetheless, firing or transferring coaches is a common phenomenon in professional football that occurs due to various reasons. Sometimes coaches themselves are willing to leave the team and sometimes managers consider firing coaches based on discretion or following poor results so as to prevent undesirable results and achieve success. In some cases, team managers change the coach as a response to the harsh criticism of fans and the media. Most researchers believe that poor performance of teams is the main reason for firing the coach and managers hope to improve team performance through this strategy. However, the effect of coach turnover on the future

performance of teams is not clear (1, 2, 11, 12, 13, 14, & 15).

Some studies have shown that changing the coach improves team performance. Fabianic (1994) and McTeer et al. (1995) found improvement in the performance of teams as a result of coach turnover. Using the data from 5 seasons of Italian "Serie A" (2003-2008), De Paola et al. (2008) examined coach turnover during these seasons and reported that, on average, 41% of the teams changed their coach at least once during a given season. 23% of matches were played under the management of a new coach, and coach changes were more frequent among low-performing teams (65% of the 10 lowest ranking teams) and rare among high-performing teams (16% of the highest ranking teams). On average, the teams managed by new coaches earned more points. Furthermore, on average, the number of goals scored per game increased and the number of goals conceded decreased, suggesting improved goal difference. This shows that new coaches were able to improve both offensive and defensive skills. In sum, this study showed that the effect of coach change on team performance is positive and statistically significant. However, the magnitude of the effect was small, where playing with a new coach yielded a team 2-3 points more every 10 matches (5). Van Vugt et al. (2008)

studied the effect of stability on the performance of professional football teams in the English Premier League (1998-2007) and in the Italian Serie A (2001-2002). They reported that of the 18 teams featured across 9 seasons of Premier League, there were 131 instances of manager stability (73%) and 49 instances of change (27%). Compared with those teams that experienced managerial stability, teams that experienced change were ranked lower at the end of the season (17). The results of Balduck et al. (2008) suggested the effect of new coaches on team quality in Belgian male soccer teams during a period of 7 seasons (1998-2005). They showed that a new coach will be able to improve the ranking of the team if the improved team quality under the new coach renders a positive team quality (18).

In contrast, some researchers have reported decline in the performance of teams as a result of coach turnover. Using the data from 26 teams in the National Football League (NFL), Brown (2006) concluded that coach changes leads to slightly more than one loss in that season. Thus, this strategy is somehow a scapegoating process by the management to placate fans and the media. Salomo and Teichmann (2000), Audas et al. (2002), and Audas et al. (2006) have also reported the negative effect of coach changes on performance (5). Ghahfarokhi and Farahani (2010) studied coach turnover in seven seasons of IPL (2001-2008) and reported that the mean coaching life is about 22 weeks. 73% of teams with coach turnover fired the new coach at the end of the same season. It was thus shown that choice, transfer, or dismissal of coaches has no scientific basis and is mostly a short-term response to the critical conditions of the team. The teams with coach changes had no improvement in performance (19). It must be noted that researchers such as Koning (2000&2002), Bruinshoofd and Ter Weel (2003), and Maximiano (2006) studied the effect of coach turnover on the performance of German, Belgian, and Italian football teams and reported no significant improvement in performance following coach turnover (16). There are many instances of coach turnover in Iran Pro League (IPL) that are mostly based on hasty, unscientific decisions, and there are different views regarding the effect of these actions on the future of teams (20). The financial structure of most teams in IPL is public and the managers make excessive use of public funds and budgets in employing or transferring players and coaches. Many scholars believe that coach turnover wastes financial resources, deteriorates performance, and reduces the quality of games (21& 22). The fired coaches are, by contract, entitled to their wage for the remainder of the contract, while the team has to pay an extortionate cost for the new coach (19& 24). These actions not only impose heavy costs on teams, but also mar the prestige of Iran's sport.

Therefore, the present research tries to examine the effect of coach stability (as opposed to coach turnover) on the performance of the teams in Iran Pro League

2. Material and Methods

The present research is descriptive-comparative and the required data is collected from the valid archival documents of the league committee of Iran's Football Federation (26). The research period is the 2009-2010 season of IPL and the population consists of 18 football teams that participated in that season. Descriptive statistics (mean, minimum, maximum, standard deviation, percentage, tables, and graphs) were used to organize the raw data and describe the obtained values. Moreover, Mann-Whitney U test was applied to examine the difference between the performances of teams with and without coach stability. The main variables of the research are coach stability and performance. According to some researchers, sudden coach dismissal within a season leads to the highest variance of performance during the process of replacement. The present research also examines coach stability within a season. Thus, the performance of stable teams (with no coach turnover in a season) is compared to that of unstable teams (with coach turnover in a season). Team performance is examined with respect to eight measures: points, rank, wins, draws, losses, goals for, goals against, and goal difference (goals scored minus goals conceded). In IPL, each win, draw, and loss has 3, 1, and 0 points respectively and the ranking of a team is determined by the sum of the earned points.

3. Results

In Table 1, coach stability in IPL during the season 2009-2010 is presented and Figure 1 is a pie chart representation of the table. 33.33 percent of the 18 teams have coach stability and 66.67 percent of teams have changed their coach at least once during the season. It must be noted that the earliest instance of coach turnover happened in the fifth week of the season and the latest instance occurred in the 32nd season (two weeks before the end of the season). 71% of all the games in the season were played under the management of new (replaced) coaches. Among the 12 teams that changed their coach during the season, about 33 percent of the teams are in the upper half and about 67 percent of the teams are in the lower half of the table. The mean coaching life in the studied season is 16.1 weeks.

In Table 2, the performance of the teams in the studied season is presented in terms of eight indices. Considering the classification of normal frequency

distribution¹ and based on the earned points, it can be concluded that one team has great performance (Sepahan Isfahan), one team has good performance (Zob Ahan Isfahan), fourteen teams have average performance (ranks 3 to 16), and two teams have poor performance (ranks 17 and 18). The maximum, minimum, and mean points earned in the league are 67, 30, and 45.16 respectively with a standard deviation of 10.01. In other words, the league champion earned 65.68 percent of maximum points and the lowest ranking team earned 29.41 percent of maximum points. A comparison of the percentage of points earned by teams with and without coach stability showed that those teams with coach stability earned 65.82 percent of the maximum points for home matches and 39.5 percent of the maximum points for away matches. However, those teams without coach stability earned 43.35 percent of the maximum points for home matches and 22.35 percent of the maximum points for away matches.

Table 4 shows the results of Mann-Whitney U test that compares the performance of teams with and without coach stability with based on the measures of performance. It is revealed that there is a significant difference in the performance of teams with and without coach stability in terms of earned points ($z = -2.29$, $p = 0.022$), rank ($z = -2.34$, $p = 0.019$), wins ($z = -2.13$, $p = 0.033$), draws ($z = -54.2$, $p = 0.011$). This shows that the wins, goal difference, and points of teams with coach stability are higher, while the draws and rank of teams without coach stability are higher. It can be concluded that coach stability leads to better performance of the teams in IPL.

4. Discussions

The results suggest the long time span of coach instability during a season, starting from the beginning weeks of the league and continuing until the last weeks. The instability in IPL is considerably higher as compared to studies carried out in other countries. In the research of Van Vugt et al. (2008), from 180 teams in 9 seasons of Premier League, 73 percent of the teams had coach stability and 27 percent had coach turnover. In De Paola et al. (2008), 41 percent of the teams had changed their coach in one season. However, in the present research 33.33 percent of the teams have coach stability and 66.67 percent of teams have changed their coach at least once within the season. On the other hand, in De Paola et al. (2008) 23 percent of games are played under the management of new coaches, while in the present research 71 percent

of the league games are played under the management of new coaches. Comparing the results with the means of previous seasons suggest the growing instability (coach turnover) of the teams in IPL, where the mean coaching life is 22 weeks in seven seasons and 16.1 weeks during the season studied in this research. This shows the increasing trend of coach turnover in Iranian football teams and it is imperative to take measures in preventing this negative approach.

The results of the present research showed that teams with coach stability had great or good performance during the season, while instability and coach turnover has been followed by average or poor performance. This finding is consistent with the results of De Paola et al. (2008) and Salomo and Teichmann (2000).

Teams with coach instability significantly outperformed teams without coach stability. This is consistent with the results of Brown (2006), Salomo and Teichmann (2000), and Van Vugt et al. (2008). However, this finding is not consistent with the results of Van Dalen (1994), Balduck et al. (2008), Fabianic (1994), McTeer et al. (1995), and De Paola et al. (2008). The consistency or inconsistency of the results of these studies and the present research may signify the different effects of coach turnover on the performance of football teams. In other words, the effect of coach turnover on performance is moderated by such variables as time of transfer, quality of the teams in the remainder of the season, and the number of home/away games played under the management of the new coach. Therefore, it is recommended that future studies take these moderators into account.

In sum, change and instability are common elements of IPL teams. Considering the positive effect of coach stability on certain measures of team performance, it can be argued that coaches are mostly fired for purposes other than getting better results, such as responding the criticism of fans and media or scapegoating in order to secure the position of the management. Moreover, instances where coaches are changed to prevent poor results have not been successful. In other words, choice, transfer, or turnover of coaches has no scientific basis and serves as a short-term response to the critical conditions of a team. Ghahfarokhi and Farahani (2010) also came to a similar conclusion regarding coach turnover in IPL. Therefore, it would be better if managers and administrators created a stable environment for coaches and made proper planning for employment or transfer of coaches. This strategy not only improves the performance of teams, but is also effective in preventing additional costs and thus enhances the economic performance and efficiency of the teams. On the other hand, due to the similarity between behaviors in athletic environments and those in the organizations

¹ ($M \pm 1.8$ SD and higher = Great); ($M \pm 1.2$ SD to $M - 1.8$ SD = Good); ($M \pm 1.2$ SD = Average); ($M + 1.8$ SD to $M - 1.8$ SD = Poor); ($M - 1.8$ SD and lower = Very poor)

of a society of which football is a part (according to Wolfe et al., 2005), it appears that the instability in Iran Pro League can be generalized to other organizations and necessary measures must be taken to prevent such a spreading feature.

References

1. Salomo, S., Teichmann, K., 2000: The relationship of performance and managerial succession in the German Premier Soccer League. *European Journal for Sport Management*, 7, 99-119.
2. Montanari, F., Silvestri, G., Gallo, E., 2008. Team performance between change and stability: The case of the Italian 'Serie A'. *Journal of Management and Marketing Research*, 22(6): 701-716.
3. Dutton, J., 2004. One scholar's garden: A narrative of renewal. In R.I Stablein and P. Frost (Eds.) *Renewing Our Research Practice: Lessons from Scholar's Journeys*, (Palo Alto: Stanford University Press) 5-17.
4. Wolfe, R., Weick, K., Usher, J., Terborg, L., Poppo, A., Murrell, J., Dukerich, D., Core, K., Dickson, Jourdan, J., 2005. Sport and organizational studies: Exploring synergy. *Journal of Management Inquiry*, 14: 182-210.
5. De Paola, M., Scoppa, V., 2008. The effects of managerial turnover: Evidence from coach dismissals in Italian soccer teams. *Journal of Sports Economics*, 13(2): 152-168.
6. Heuer, A., Müller, C., Rubner, O., Hagemann, N., Strauss, B., 2011. Usefulness of dismissing and changing the coach in professional soccer. *PLoS One*, 6(3):e17664.
7. Van Dalen, H.P., 1994. Loont het om een voetbaltrainer te ontslaan? *Economisch Statistische Berichten*, 79: 1089-1092.
8. Allen, M.P., Panian, S.K., Lotz, R.E., 1979. Managerial succession and organizational performance: A recalcitrant problem revisited. *Administrative Science Quarterly*, 24: 167-180.
9. Maduni, A.N., 2009. The effect of coaching behaviors on coach's efficiency and team dynamism in Iranian Volleyball Super League. Doctoral Dissertation, Tarbiat Moallem University.
10. McGettigan, J.P., 1983. *Winning soccer drills*. Simon & Schuster.
11. Koning, R.H., 2003. An econometric evaluation of the firing of a coach on team performance. *Applied Economics*, 35(5):555-564.
12. Pfeffer, J., Davis-Blake, A., 1986. Administrative succession and organizational performance: How administrator experience mediates the succession effect. *Academy of Management Journal*, 29: 72-83.
13. Audas, R., Dobson, S., Goddard, J., 1999. Organizational performance and managerial turnover. *Managerial and Decision Economics*, 20: 305-318.
14. De Dios Tena, J., Forrest, D., 2006. Within-season dismissal of football coaches: Statistical analysis of causes and consequences, *European Journal of Operational Research*, 118(1): 362-373.
15. Frick, B., Simmons, R., 2005. The impact of managerial quality on organizational performance: Evidence from German soccer. The Department of Economics, Lancaster University.
16. Koning, R.H., 2003. An econometric evaluation of the firing a coach on team performance. Department of Econometrics, University of Groningen.
17. Van Vugt, M., Hart, C., Leader, T. 2008. Does stability foster team performance? A European football (soccer) inquiry. Manuscript submitted for publication.
18. Balduck, A.L., Prinzie, A., Buelens, M., 2008. The effectiveness of coach turnover and the effect on home team advantage, team quality and team ranking. Faculty of Economics and Business Administration, Ghent University, Belgium.
19. Ghahfarokhi, E.A., Farahani, M.J., 2010. A study of coach turnover in Iran Pro League. *Journal of Olympics*, 3: 47-57.
20. Kordi, M.R., 2002. A study of the view of coaches, experts, and referees regarding the problems of football in Iran. Department of Research and Cultural Affairs, Physical Education Organization.
21. Ghahfarokhi, E.A., 2010. An analysis of the obstacles in implementation of the general policies of Article 44 of Constitution regarding professional sports of Iran with an emphasis on football. Doctoral Dissertation, University of Tehran.
22. Assadi, H., 2009. A study of the current condition of Iran's professional football teams and comparison with the standards of Asian Football Confederation. Master's Thesis, University of Tehran.
23. Jalali, M., 2010. *Pathology of Iran Pro League*. Sepahan F.C. Publications, Isfahan.

9/6/2012

Life Science Journal

(Acta Zhengzhou University Overseas Edition)

Call for Papers

The academic journal “*Life Science Journal*” (ISSN: 1097-8135) is inviting you to publish your papers.

Life Science Journal, the Acta Zhengzhou University Oversea Version registered in the United States, is an international journal with the purpose to enhance our natural and scientific knowledge dissemination in the world under the free publication principle. The journal is calling for papers from all who are associated with Zhengzhou University-home and abroad. Any valuable papers or reports that are related to life science-in their broadest sense-are welcome. Other academic articles that are less relevant but are of high quality will also be considered and published. Papers submitted could be reviews, objective descriptions, research reports, opinions/debates, news, letters, and other types of writings. Let's work together to disseminate our research results and our opinions.

Please send your manuscript to editor@sciencepub.net.

Address:

Life Science Journal - Acta Zhengzhou University Overseas Edition

Marsland Press

PO Box 180432, Richmond Hill, New York 11418, USA

Telephone: (347) 321-7172

Emails: editor@sciencepub.net; sciencepub@gmail.com; lifesciencej@gmail.com;

Website: <http://www.sciencepub.net>; <http://www.lifesciencesite.com>

Volume 9, Number 4, (Cumulative No.31) Part 17 December 25, 2012 ISSN:1097-8135

Life Science Journal

Marsland Press

PO Box 180432, Richmond Hill, New York 11418, USA

Website:
<http://www.sciencepub.net>

Emails:
editor@sciencepub.net
sciencepub@gmail.com

Phone: (347) 321-7172

Copyright © 2005-2012 Marsland Press / Zhengzhou University

