

# Life Science Journal

# Life Science Journal

Marsland Press

PO Box 180432, Richmond Hill, New York 11418, USA

Website:  
<http://www.sciencepub.net>

Emails:  
[editor@sciencepub.net](mailto:editor@sciencepub.net)  
[sciencepub@gmail.com](mailto:sciencepub@gmail.com)

Phone: (347) 321-7172

Life Science Journal 2012 Volume 9, Number 4, Part 20 ISSN:1097-8135



Volume 9, Number 4, Part 20 December 25, 2012 ISSN:1097-8135

# Life Science Journal



**MARSLAND PRESS**  
Multidisciplinary Academic Journal Publisher

Websites:  
<http://www.lifesciencesite.com>  
<http://www.sciencepub.net>

Emails:  
[lifesciencej@gmail.com](mailto:lifesciencej@gmail.com)  
[editor@sciencepub.net](mailto:editor@sciencepub.net)

# Life Science Journal

Acta Zhengzhou University Oversea Version  
(Life Sci J)

**Life Science Journal**, the Acta Zhengzhou University Oversea Version, is an international journal with the purpose to enhance our natural and scientific knowledge dissemination in the world under the free publication principle. The journal is calling for papers from all who are associated with Zhengzhou University-home and abroad. Any valuable papers or reports that are related to life science - in their broadest sense - are welcome. Other academic articles that are less relevant but are of high quality will also be considered and published. Papers submitted could be reviews, objective descriptions, research reports, opinions/debates, news, letters, and other types of writings. Let's work together to disseminate our research results and our opinions.

**Editor-in-Chief:** Shen, Changyu, Ph.D., Professor, Chinese Academy of Sciences

**Associate Editors-in-Chief:** Ma, Hongbao; Cherng, Shen; Xin, Shijun

**Editorial Boards:** Aghdam, Hashemi; An, Xiuli; Chandra, Avinash; Chen, George; Dong, Ziming; Duan, Guangcai; Edmondson, Jingjing; Gao, Danying; Huang, Shuan-Yu; Li, Xinhua; Li, Yuhua; Lindley, Mark; Liu, Hua; Liu, Hongmin; Ma, Margret; Qi, Yuanming; Sabyasachi Chatterjee; Shang, Fude; Shi, Lifeng; Song, Chunpeng; Sun, Yingpu; Wang, Lidong; Wen, Jianguo; Xu, Cunshuan; Xu, Yuming; Xue, Changgui; Zaki, Mona; Zhang, Jianying; Zhang, Kehao; Zhang, Shengjun; Zhang, Xueguo; Zhang, Zhan; Zhang, Zhao; Zhu, Huaijie

## Introductions to Authors

### 1. General Information

- (1) **Goals:** As an international journal published both in print and on internet, **Life Science Journal** is dedicated to the dissemination of fundamental knowledge in all areas of nature and science. The main purpose of **Life Science Journal** is to enhance our knowledge spreading in the world under the free publication principle. It publishes full-length papers (original contributions), reviews, rapid communications, and any debates and opinions in all the fields of nature and science.
- (2) **What to Do:** The **Life Science Journal** provides a place for discussion of scientific news, research, theory, philosophy, profession and technology - that will drive scientific progress. Research reports and regular manuscripts that contain new and significant information of general interest are welcome.
- (3) **Who:** All people are welcome to submit manuscripts in life science fields. Papers of other fields are also considered.
- (4) **Copyright and Responsibility of Authors to their Articles:** When the manuscript(s) is submitted to the journal, the authors agree the following: All the authors have participated sufficiently in this work; The article is not published elsewhere; Authors are responsibility on the contents of the article; The journal and author(s) have same right for the copyright of the article and either of the journal or author(s) can use it by anyway without noting the other party.
- (5) **Publication Costs:** US\$500 per article to defray costs of the publication will be paid by the authors when it is received. Extra expense for color reproduction of figures will be paid by authors (estimate of cost will be provided by the publisher for the author's approval).
- (6) **Advertisements:** The price will be calculated as US\$400/page, i.e. US\$200/a half page, US\$100/a quarter page, etc. Any size of the advertisement is welcome.

### 2. Manuscript Preparation

Each manuscript is suggested to include the following components but authors can do their own ways:

- (1) **Title:** including the complete article title; each author's full name; institution(s) with which each author is affiliated,

with city, state/province, zip code, and country; and the name, complete mailing address, telephone number, facsimile number (if available), and at least one email address for author(s). (2) **Abstract:** including Background, Materials and Methods, Results, and Discussions. (3) **Key Words.** (4) **Introduction.** (5) **Materials and Methods.** (6) **Results.** (7) **Discussions.** (8) **Acknowledgments.** (9) **References.**

### 3. Manuscripts Submission

- (1) **Submission Methods:** Submission through email ([editor@sciencepub.net](mailto:editor@sciencepub.net)) is encouraged.
- (2) **Software:** The Microsoft Word file will be preferred.
- (3) **Font:** Normal, Times New Roman, 10 pt, single space.
- (4) **Indent:** Type 2 space in the beginning of each new paragraph.
- (5) **Manuscript:** Don't use "Footnote" or "Header and Footer".
- (6) **Email:** At least one author's email must be put under title.
- (7) **Title:** Use Title Case in the title and subtitles, e.g. "**Debt and Agency Costs**".
- (8) **Figures and Tables:** Use full word of figure and table, e.g. "**Figure 1. Annual Income of Different Groups**", **Table 1. Annual Increase of Investment**".
- (9) **References:** Cite references by "last name, year", e.g. "(Smith, 2003)". References should include all the authors' last names and initials, title, journal, year, volume, issue, and pages etc.

#### Reference Examples:

**Journal Article:** Hacker J, Hentschel U, Dobrindt U. Prokaryotic chromosomes and disease. *Science* 2003;301(34):790-3. **Book:** Berkowitz BA, Katzung BG. Basic and clinical evaluation of new drugs. In: Katzung BG, ed. Basic and clinical pharmacology. Appleton & Lance Publisher. Norwalk, Connecticut, USA. 1995:60-9.

- (10) **Submission Address:** [editor@sciencepub.net](mailto:editor@sciencepub.net), Marsland Press, PO Box 180432, Richmond Hill, New York 11418, USA, 347-321-7172.

Marsland Press / Zhengzhou University  
PO Box 180432, Richmond Hill, New York 11418, USA  
<http://www.lifesciencesite.com>; <http://www.sciencepub.net>  
[lifesciencej@gmail.com](mailto:lifesciencej@gmail.com); [editor@sciencepub.net](mailto:editor@sciencepub.net)  
© 2005-2012 Marsland Press / Zhengzhou University

# CONTENTS

428	<b>Characterization of Lactic Acid Bacteria Isolated from Dairy Products in Egypt as a Probiotic.</b> Rasha H. Bassyouni., Walla S. Abdel-all , Mostafa G. Fadl Saed Abdel-all and Zeinat kamel	2924 -2933
429	<b>Perception of Food Safety and Prevalence of <i>Staphylococcus aureus</i> and <i>Salmonella</i> species Carriers among Fayoum University Food handlers</b> Rasha H. Bassyouni, Naglaa El-Sherbiny, Enas H. Hefzy, Ahmed- Ashraf Wegdan	2934 -2940
430	<b>Factors in the expansion of NATO after the Cold War</b> Iraj Mazarei	2941-2949
431	<b>The Use of Different Tense in Autistic Children</b> Ameneh Zare, Shahin Nematzadeh	2950-2954
432	<b>Fuzzy Logic Improved StaticSynchronousCompensator to Control Voltage of a Grid-connected Squirrel Cage Induction Generator</b> Reza Sharifian Dastjerdi, Ehsan Jafari, Farshad Kabiri, Payam Ghaebi Panah	2955-2960
433	<b>Comparison of viewpoints of staff members and students toward equipment and facilities of university</b> Dr Mohsen Ghofrani	2961-2962
434	<b>The viewpoint of university students and Staff members towards education</b> Dr Mohsen Ghofrani	2963-2965
435	<b>Structural analysis of the relationship between optometric practices and knowledge sharing intention</b> Kun-Shiang Chen	2966-2968
436	<b>Evaluation of correlation between serum immunoglobulin levels and extent of hepatic fibrosis in patients with chronic B hepatitis</b> Rasoul Estakhri, Mohammad Hossein Somi, Abdolreza TabanSadeghi, Babak Hajipour, Faeghe Tajallayi.	2969-2974
437	<b>Higher-order asymptotic formula for the eigenvalues of Sturm-Liouville problem with indefinite weight function in the Neumann boundary condition</b> Farhad Dastmalchi Saei , A. Jodayree Akbarfam	2975-2979
438	<b>Solutions of Twelfth -Order Boundary Value Problems Using Polynomial Spline in Off Step Points</b> Karim farajeyan ; Nader Rafati Maleki; Shahram Banaei	2980-2985
439	<b>Estimation of chemical resistance of PFM dental ceramics by neural network</b> Siamak haghypour, Sayana rostami	2986-2996
440	<b>Long-term Resveratrol Administration Reduces Renal Oxidative Stress and</b>	2997-3001

	<b>Apoptosis Rate In Experimental Model of Type 2 Diabetes.</b> Saeed Khamneh, Farhad Ghadiri Soufi, Fatemeh Afshar	
<b>441</b>	<b>The effect of ownership structure of corporate governance on agency cost</b> Y.B. Nhandi, H. Baradaran hasanzade, GH. Sharifzade	<b>3002-3010</b>
<b>442</b>	<b>Political Structure and Administrative System of Poshtkooh (Ilam) In the period of Valian</b> Ebrahim Yaghobi , Sivash Yari	<b>3011-3019</b>
<b>443</b>	<b>The First Report for the invasion of Artemia franciscana Kellogg 1906in Tashk and Bakhtegan Lakes, Iran</b> SepidehShafaie, SamadZare, RaminManaffar and Afagh Falahati	<b>3020-3024</b>
<b>444</b>	<b>The renal toxicity of hydroalcoholic extract of Stachys lavandulifolia Vahl in Wistar rats</b> Taghikhani M, Nasri H, Asgari A, Afrough H, Namjoo AR,Ansari-Samani R, Shahinfard Nand Rafieian-kopaei	<b>3025-3031</b>
<b>445</b>	<b>Striae Gravidarum in Iranian Women: Prevalence and Associated Factors</b> Nasim Bahrami, Mohammad Ali Soleimani, Hamid Sharif Nia, Reza Masoodi , Hoorieh Shaigan and Mitra Hekmat Afshar	<b>3032-3037</b>
<b>446</b>	<b>Risk factors of renal stone in patients with recurrent nephrolithiasis: A case-control study</b> Ali Ghorbani, Heshmatollah Shahbazianand Leila Moradi	<b>3038-3043</b>
<b>447</b>	<b>The Effect of Attitudes on Managers Creativity</b> Azita Sherej Sharifi and Maryam Charrakh	<b>3044-3051</b>
<b>448</b>	<b>Comparison of radial basic function (RBF) and Statistica in daily flow forecasting</b> Mahdi Moharrampour and Mohammad Kherad Ranjbar	<b>3052-3058</b>
<b>449</b>	<b>The Impact of CRM Application on Customer Satisfaction in Financial Institutions (Case Study: Financial Institutions in Iran)</b> Maryam Charrakh and Azita Sherej Sharifi	<b>3059-3066</b>
<b>450</b>	<b>Bottom Deformation of Dock Settling Basin on Elastic Foundation</b> Abolfazl Nazari Giglou, Gita Eynollahi, Taher Nazari Giglou	<b>3067-3072</b>
<b>451</b>	<b>CXCR4 Expression on Peripheral Blood T-Lymphocytes in Patients with Systemic Lupus Erythematosus and its Relation to Disease Activity</b> Dina S. Al-Zifzaf, Abir M. Nabil, Rasha Mamdouh and Reem A K khattab	<b>3073-3079</b>

**Characterization of Lactic Acid Bacteria Isolated from Dairy Products in Egypt as a Probiotic.**Rasha H. Bassyouni.<sup>1</sup>, Walla S. Abdel-all<sup>2</sup>, Mostafa G. Fadl<sup>2</sup> Saed Abdel-all<sup>2</sup> and Zeinat kamel<sup>3\*</sup><sup>1</sup>Medical Microbiology and Immunology Department, Faculty of Medicine, Fayoum University<sup>2</sup>Microbiology Department, National Organization of Drug Control & Research<sup>3</sup>Botany Department, Faculty of Science, Cairo University[zeinatk@yahoo.com](mailto:zeinatk@yahoo.com)

**Abstract:** *Lactobacilli* belong to lactic acid bacteria (LAB), generally recognized as safe primary fermentation end product from sugars is lactic acid and that is why foods are conserved. Lactic acid bacteria have been used for improving health host. Therefore, they are an important part of intestinal flora in human and animals as probiotic. This research aimed to isolate lactic acid bacteria with significant probiotic character from different dairy products. In this study, homo- fermentative LAB were isolated from different dairy products in Egypt. Isolates were identified by morphological, biochemical and physiological methods. Probiotic properties of isolates were investigated. The isolated bacteria were studied for antagonistic effects on clinically isolated *E.coli*, *Salmonella* spp. *Micrococcus* spp., *Staphylococcus* spp. A collection of fifty four isolates were obtained. Eight isolates from different dairy products were observed as potential probiotic safe for human use; where they found to be tolerant to low pH and bile salt and effective against isolated *E.coli*, *Salmonella* spp. *Micrococcus* spp. All isolates were screened for enzymatic activity using API ZYM Kits and antibiotic sensitivity. Biochemical and physiological results indicated that they were found to be related to the genus *Lactobacillus* and suggested to belong to *L. casei* (4 isolates), *L. Acidophilus* (3 isolates) and *L. lactis*(1 isolates) and that were effective on the isolated *E.coli*, *Salmonella* spp. *Staphylococcus* spp. and they have enzymatic activity.  $\beta$ -galactosidase was produced, which is beneficial for lactose intolerance. *Lactobacillus* spp. produced enzymes including leucine arylamidase, cystine arylamidase, acid phosphatase, naphthol-AS-BI-phosphohydrolase,  $\alpha$ -galactosidase,  $\beta$ -galactosidase,  $\alpha$ -glucosidase,  $\beta$ -glucosidase, and N-acetyl- $\beta$ -glucosamidase so we concluded that human milk, yogurt and raw milk are considered a good source of potential probiotic strains also the isolated bacteria had no haemolytic activity so it consider as a great potential probiotic and safe for human use. [Rasha H. Bassyouni, Walla S. Abdel-all b, Mostafa G. Fadl Saed Abdel-all and Zeinat kamel **Characterization of Lactic Acid Bacteria Isolated from Dairy Products in Egypt as a Probiotic.** *Life Sci J* 2012;9(4):2924-2933]. (ISSN: 1097-8135). <http://www.lifesciencesite.com>. 428-2933]. (ISSN: 1097-8135). <http://www.lifesciencesite.com>. 428.

**Keywords:** *Lactobacilli*, Probiotic .Bile salt, Acid tolerance, Enzymatic activity, Antimicrobial activity, Hemolytic activity.

**1. Introduction**

Lactic acid bacteria (LAB) are a group of Gram-positive rods and cocci occurring naturally in a variety of niches, including the gastrointestinal tract, plants and fermented foods such as dairy products, meat and alcoholic beverages (Hammes and Hertel, 2006; Mohania et al., 2008). Probiotics are defined as “live microorganisms which when administered in adequate amounts confer a health benefit on host” (the Food and Agriculture Organization/World Health Organization (FAO/WHO). Most probiotics commercially available today belong to the genera *Lactobacillus* and *Bifidobacterium*. LAB are the most important group of microorganism used in food fermentations, they contribute to the fast and texture of fermented products and inhibit food spoilage and pathogenic bacteria by producing antimicrobial substances (lactic acid, hydrogen peroxide, bacteriocin) (Phillip et al., 2012). Several mechanisms by which probiotics mediate their health benefits on the host have been suggested, and can be divided into three categories; (i) certain probiotics have antimicrobial activity and can

exclude or inhibit pathogens; (ii) probiotic bacteria can enhance the intestinal epithelial barrier; and (iii) probiotic bacteria are believed to modulate the host immune response (Ezendam and Loveren, 2006; Marco et al., 2006; Lebeer et al., 2008; Lebeer et al., 2010). The mechanisms of health promoting effects of probiotic bacteria have proven difficult to elucidate in detail, and traditionally most attention has been given to their anti-pathogenic properties (Lebeer et al., 2008). To perform their effect in the intestine, probiotic bacteria should be capable of surviving passage through the GIT (gastro intestinal tract). Thus, it is essential for the bacteria to have protection systems to withstand the low pH in the stomach, digestive enzymes and bile of the small intestine. Approximately pH 2.5 l of gastric juice (Cotter and Hill, 2003) and pH1 l of bile (Begley et al., 2005) are secreted into the human digestive tract every day. Tolerance to gastric acid and bile has thus become important selection criterion for probiotic strains. (Jensen et al., 2012).

Lactobacilli are ubiquitous and widespread commensal bacteria in the human and animal micro

flora. They are widely used by humans: as adjuvants against gastrointestinal disorders, as dietary supplements, and as biological food processors based on their fermentative properties (Beasley *et al.*, 2004). *Lactobacilli* are gram-positive, non-spore-forming rods. It is possible for this resistance to be transmitted to the human population through the food chain. Although many strains are not pathogenic, they could constitute a reservoir of genes conferring resistance to antibiotics which might be transferred to pathogenic strains (Rattanachaikunsopon *et al.*, 2010) The study of health-beneficial effects that probiotic bacteria can exert on humans and animals is at its beginning. Pending scientific questions include the identification of molecular markers of the health-promoting activity of specific strains, which may be used to select novel probiotic strains and to gain understanding of the mechanisms underlying their effects. LAB can be isolated from different sources (Phillip *et al.*, 2012) including African grape and wine sample also Selective enumeration of *lactobacillus* spp. Was isolated from cheese (Karimi *et al.*, 2012.), Similarly Vitali *et al.* (2012) Isolated novel probiotic bacteria from raw fruits and vegetables *lactobacillus* can be isolated from plant as reported by Hurtado *et al.* (2012), also isolated Lactic acid bacteria from fermented table olives (Abriouel, 2012). The aim of this study was to isolates safe and potential probiotic *lactobacillus* spp. From different dairy products.

## 2. Material and Methods:

### 1. Isolation of Lactic Acid Bacteria from dairy products

The isolation material was from different sources of dairy product obtained from market. The samples were collected in sterile carriers and stored on ice until delivery to the laboratory. Once delivered to the laboratory, they were taken to the procedure for isolation. Pour plate technique was used to isolate the organisms. Samples were used directly and also diluted to  $10^{-1}$ ,  $10^{-2}$  and  $10^{-3}$  using sterile peptone water. 1 ml aliquot of the samples and dilutions were plated into selective medium MRS (Man, Rogosa and Sharpe) agar (Oxoid LTD, Basingstoke, England) according to Dave and Shah (1996). The plates were incubated at 37 °C for 3 days under aerobic conditions. After incubation, individual colonies were selected and transferred into sterile broth media. The selected colonies were purified by streak plate technique. The isolates were examined according to their colony morphology, catalase reaction and gram reaction survival at different temperature and tolerance to NaCl concentrations also methyl red and vogues proskaure. Gram positive and catalase negative bacilli colonies were taken as lactic acid

bacteria stored in glycerol culture and kept for further investigation at -20°C.

## 2. Identification

### 2.1 Carbohydrate fermentations of isolates

The tested carbohydrates were D (+) cellobiose (Sigma, Detroit, MI, USA), D (+) galactose (Sigma), lactose (Sigma), fructose (Sigma), maltose 1-hydrate (Sigma), D mannitol (Sigma), D (+) melezitose (Sigma), melibiose (Sigma), D (-) raffinose (Difco), rhamnose (Sigma), ribose (Sigma), sorbitol (Sigma), D (+) trehalose (Sigma), and D (+) xylose (Merck, Darmstadt, Germany); glucose (Sigma), and sterile water were used as positive and negative controls. During the test, stored in glycerol culture and kept for further investigation at -20°C.

### 2.2 Arginine hydrolysis test

For arginine hydrolysis test, base MRS broth (Oxoid LTD, Basingstoke, England) without glucose and meat extract containing 0.3% arginine and 0.2% sodium citrate instead of ammonium citrate was used. Arginine MRS medium and Nessler's reagent were used in order to see ammonia production from arginine. MRS containing 0.3% L-arginine hydrochloride was transferred into tubes as 5 ml and inoculated with 1% overnight cultures. Tubes were incubated at 37 °C for 24hrs. After incubation, 100 µl of cultures transferred onto a white back ground. The same amount of Nessler's reagent was pipetted on the cultures. The change in the color was observed. Bright orange color indicated a positive reaction while yellow indicated the negative reaction. A negative control, which did not contain arginine, was also used.

2.3. Growth at different temperature and growth at different NaCl concentrations was carried out according to method described by Briugs (1953). Gram stain, urea test, Methyl Red Test and Vogues Prosquer test were determined as described by Prescott and Harley (2002).

### 3. Probiotic Properties of Isolates

Major selection criteria (resistance to low pH, tolerance against bile salt and the antimicrobial activity) were chosen for the determination of probiotic properties of isolates.

#### 3.1. Resistance to Low pH

Resistance to pH 3 is often used *in vitro* assays to determine the resistance to stomach pH. Because the foods are staying during 3 hrs, this time limit was taken into account for this purpose. Active cultures (incubated for 16-18 hrs) were used. Cells were harvested by centrifugation for 10 min at 5000 rpm and 4°C. Pellets were washed once in phosphate-saline buffer (PBS at pH 7.2). Then cell pellets were suspended in PBS (pH 3) and incubated at 37 °C. Viable microorganisms were enumerated at the 3 hours with pour plate techniques. Appropriate dilutions were done and

plates were incubated at 37°C under aerobic conditions for 48 h. Also growth was monitored by absorbance at OD620.

### 3.2. Tolerance against Bile

Because the mean intestinal bile concentration is believed to be 0.3% (w/v) and the staying time of food in small intestine is suggested to be 4 hrs (Kumar and Murugalatha, 2012), the experiment was applied at this concentration of bile for 4 hrs. MRS medium containing 0.3% bile was inoculated with active cultures and incubated for 16-18 hrs. During the incubation for 4 hrs, viable colonies were enumerated for every hour with pour plate technique and also growth was monitored by absorbance at OD620.

### 3.3. Evaluation of Antagonistic Activity

Antimicrobial effects of presumptive strains of *Lactobacillus spp.* were determined by the agar diffusion method. The tested bacteria were incubated in nutrient broth at appropriate temperature for 24 hours. Approximately  $10^5$ -  $10^7$  cfu/ml of the bacteria to be tested for sensitivity (indicator bacteria) were inoculated (1%) into 20 ml of nutrient agar and poured into the Petri dishes. To detect antibacterial activity of *Lactobacillus spp.*, MRS containing only 0.2% glucose was used. 10 ml of broth was inoculated with each strain of *Lactobacillus spp.* and were incubated at 35 °C for 48 hours. After incubation, a cell-free solution was obtained by centrifuging (6000 × g for 15 min) the culture. Some supernatants were neutralized by 1 N NaOH to pH 6.5, supernatants of the strains of *Lactobacillus spp.* were checked for antibacterial activity against pathogenic bacteria in inoculated nutrient agar. Then 100 ml of cell free supernatants was filled in 8-mm diameter sealed wells cut in the nutrient agar. Once solidified, the dishes were stored for two hours in a refrigerator. The inoculated plates were incubated for 24 hours at 37 °C, and the diameter of the inhibition zone was measured by calipers in millimeters (Leo, 1998; Mir-hoseini, 2004).

## 4. Safety assessment

### 4.1 Test of isolates for antibiotic sensitivity

The isolates were tested for resistance to 15 antibiotics (Ampicillin/sulpectam, amoxicillin, claviolinic acid, Amoxicilin, Clarithromycin, Erythromycin, Naldixic acid, Trimethoprim/sulphamethoxazolin, Ciprofloxacin, tetracycline, Vancomycin, Rifampicin, Nitrofurantoin, chloramphenicol, Tenadazole). This test was performed using the standard disc diffusion method (National Committee for Clinical

Laboratory Standards, 2000; SCAN, 2000; Herreros *et al.*, 2005; Phillip, 2012; Jensen, 2012).

### 4.2. Analysis of Enzyme Activity of *lactobacillus* isolates.

The API ZYM kit (bio-Mérieux, France) was used to study enzyme activity production by isolates. Each identified isolate was grown overnight at 37°C on MRS broth. Sediment from centrifuged culture broth was used to prepare a suspension at  $10^5$  CFU/ml. After inoculation, cultures were incubated for 4 h at 37°C. Placing a Surface-active agent (ZYM A reagent) in the cupules facilitated solubilization of the ZYM B reagent in the medium. Color was allowed to develop for at least 5 min, and values ranging from 0-5 were assigned corresponding to the colors developed. The approximate number of free n mole of hydrolyzed substrate was determined based on the color strengthen negative reaction; 1, 5 nmol; 2, 10 nmol; 3, 20 nmol; 4, 30 nmol; 5, 40 nmol or higher

### 4.3 Test for hemolytic activity of *lactobacillus* spp.

Isolates were screened on blood agar plates containing 5% sheep blood and incubated at 37 °C for 48 hours. Hemolytic activity was detected as the presence of a clear zone around bacterial colonies (Nour-Eddine, 2006)

## 3. Results and Discussion:

### 1. Isolation and Identification of lactic acid bacteria

Fifty four isolates were isolated from different dairy product.

#### 1.1. Morphological and Biochemical Identification

Isolates were characterized according to the method recommended by Bergey's manual of systematic Bacteriology (Brinner *et al.*, 2001), 54 isolated bacteria were tested to select *lactobacillus* spp. which have the following characteristics aerobically, gram-positive, catalase-negative and homofermentative bacilli that have yellowish, mucoid, rounded colonies. The species of *lactobacillus* identified by carbohydrates fermentation pattern, growth at 10°C, 15°C, 30°C and 35°C, growth at different NaCl concentration, arginine hydrolysis, urease test and carbohydrate fermentations as reported by Cullimore (2008). (Table 1)

**Table1: Stander identification of genus of *lactobacillus***

NO.	FAMILIES	MOT.	AERO.	G35°C	CAT.	H2S	A gluc
A	<i>LACTOBACILLUS</i>	-	FA	+	-	-	+
B	<i>ERYSIPELOTHRIX</i>	-	FA	+	-	+	+

Mot, motile; aero, aerobically; fa, facultative anaerobic; SA be, strict aero, G35°C, growth at 35°C; cat, catalase; H<sub>2</sub>S, hydrogen sulphide produced; A gluc, acid from glucose.



**Table 2: Stander identification of *lactobacillus* spp.**

	Ac	Ae	Al	Am	Ar	Ag
<i>L. lactis</i>	+/-	+	+	-	-	+/-
<i>L. acidophilus</i>	+	+	+	-	-	+
<i>L. casei</i>	+	+	+	+	+	+

(Ac, acid from cellobiose Ae, acid from esculin Al, acid from lactose Am, acid from mannitol; Ar, Acid from raffinose, Ag, acid from galactose.)

According to the biochemical characteristics (Tables 2,3), all isolates did not produced gas from glucose and did not produce ammonia from arginine. They tolerated 2%NaCl and 6.5%NaCl and 10%NaCl concentrations (Tables 3,4) and grew at 30°C, 35°C, 45 °C (Table 3). Isolates S8, S7, S3 gave positive results with the carbohydrates, glucose, ramnose, mannose, arabinose, raffinose, galactose, sucrose and lactose. Isolates S2, S4, S6, S5. gave positive test results with sugars, glucose, ramnose, mannitol, fructose, maltose, raffinose, galactose, maltose, sucrose, fructose and lactose. and B.M. (breast milk) give positive result ramnose, mannitol, fructose, inositol, raffinose, mannose, maltose, lactose. Based on these biochemical. It seems that S8, S7, S3 is like to be *Lactobacillus acidophilus* (3 isolates), S2, S4, S6 may be identified as *Lactobacillus casei* (4 isolates) and B.M. is like to be *Lactobacillus lactis*. (Roos *et al.*, 2005; Hammes and Hertel 2006). The physiological and biochemical and morphological characters of identified *Lactobacillus* are reported in table 6. LAB are the most important group of

microorganism used in food fermentation are predominant participant in many industrial products and plant and dairy fermentations various species of *lactobacillus* are the most commonly used probiotic microorganism (Ranadheera *et al.*, 2012) and played the dual role of starter and probiotic. Recently, significant attention has been paid to fermented dairy products containing probiotic bacteria. Isolation of LAB from dairy product obtained in the present results was similar to many recent reports (Wang *et al.*, 2010; Duskoval *et al.*, 2012). In relation to the present result *L. acidophilus* was isolated from cheese (karimi *et al.*, 2012). Liu *et al.* (2012) found that *L.lactis* and *L.casei* were considered as the predominated species in fermented dairy product (Tarag). LAB play an important role in the production of a range of traditional fermented foods and have also previously been reported to be present in high numbers in many foods including fura (Owusu *et al.*, 2012), green table olive (Abioue *et al.*, 2012), cereal foods (Oguntoyinbo *et al.*, 2012) and curd and cucumber (Patil *et al.*, 2010).

**Table 3: Biochemical characteristics OF *lactobacillus* isolates**

Isolates No.	Acid from Glucose	methyl red	vogues prosequer	Urease test	Survival at 60 c for 90 min	Survival at 60 c for 60 min.	Growth at 45°C	Growth at 35°C	Growth at 30°C	Growth at 15°C	Growth at 10°C	2%NaCl	Gas from glucose	Motility	Catalase	Shape	aerobicity	Ammonia from Arginine
S1	+	+	-	-	-	-	-	+	+	-	-	+	-	-	-	bacilli	f.a	-
S2	+	+	-	-	-	-	-	+	+	-	-	+	-	-	-	bacilli	f.a.	-
S3	+	+	-	-	-	-	-	+	+	-	-	+	-	-	-	bacilli	f.a.	-
S4	+	+	-	-	-	-	-	+	+	-	-	+	-	-	-	bacilli	f.a.	-
S5	+	+	-	-	-	-	-	+	+	-	-	+	-	-	-	bacilli	f.a.	-
S6	+	+	-	-	-	-	-	+	+	-	-	+	-	-	-	bacilli	f.a.	-
S7	+	+	-	-	-	-	-	+	+	-	-	+	-	-	-	bacilli	f.a.	-
S8	+	+	-	-	-	-	-	+	+	-	-	+	-	-	-	bacilli	f.a.	-
B.M..	+	+	-	-	-	-	-	+	+	-	-	+	-	-	-	bacilli	f.a.	-

**Table 4: Physiological characteristic. Of lactobacillus isolates**

Isolate no.	15. % NaCl	10. % NaCl	6.5%NaCl	2%NaCl	Ammonia from Arginine	Gas from glucose	Catalase	Motility
S1	-	+	+	+	-	-	-	-
S2	-	+	+	+	-	-	-	-
S3	-	+	+	+	-	-	-	-
S4	-	+	+	+	-	-	-	-
S5	-	+	+	+	-	-	-	-
S6	-	+	+	+	-	-	-	-
S7	-	+	+	+	-	-	-	-
S8	-	+	+	+	-	-	-	-
B.M.	-	+	+	+	-	-	-	-

**Table 5: carbohydrate fermentation of lactobacillus isolates(B.M., human milk)**

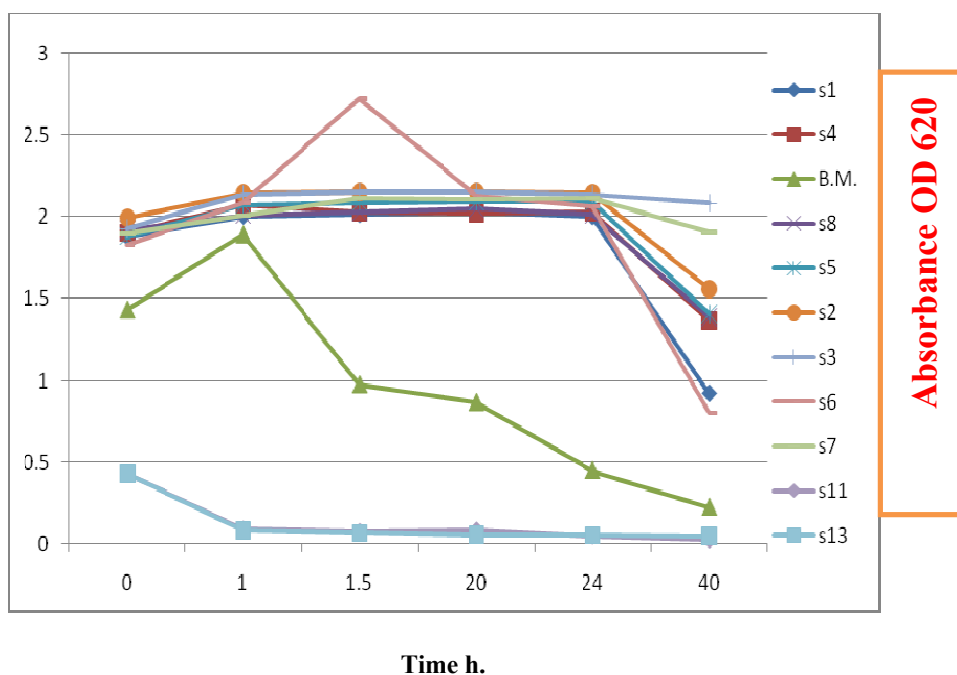
SUGER	S1	S2	S3	S4	S5	S6	S7	S8	B.M.
RAMNOS	+	+	+	+	+	+	+	+	+
MANNITOL	+	+	-	+	+	+	-	-	+
FRUCTOS	+	+	-	-	+	+	-	-	+
INOSITOL	-	-	+	-	-	-	-	-	+
SALICIN	-	-	+	-	-	-	-	-	-
RAFINOSE	+	+	-	+	+	+	+	+	+
MANNOSE	-	-	-	-	-	-	+	+	+
MALTOSE	-	+	-	+	-	+	-	-	+
LACTOSE	+	+	+	+	+	+	+	+	+

**Table 6: Morphological and biochemical properties of identified Lactobacillus spp.**

Characteristics	<i>L. acidophilus</i>	<i>L. casei</i>	<i>L. lactis</i>
Cell shape	Bacilli	Bacilli	Bacilli
Catalase test	-	-	-
Motility	-	-	-
Aerobicity	f.a	f.a	f.a
Acid, from glucose	+	+	+
Gas from glucose	-	-	-
Ammonia from arginine	-	-	-
Growth at different temp. 35C 30C 15C 10C	+	+	+
Growth at NaCl 10,6.5,4,2.5	+	+	+
Growth at pH 3 for 1 hour 2 hours 3 hours	+	+	+
Vogues prosquer	-	-	-
Methyl red	+	+	+
Urease test	-	-	-
RAMNOS	+	+	+
MANNITOL	-	+	+
FRUCTOS	-	+	+
INOSITOL	-	-	+
SALICIN	-	-	-
RAFINOSE	+	+	+
MANNOSE	+	-	+
MALTOSE	-	+	+
LACTOSE	+	+	+

## 2-Probiotic characterization

### 2.1. Survival of lactobacillus Spp. isolates in pH 3.0



**Figure 1: Survival of isolates in pH 3.0 – absorbance at OD<sub>620</sub> values**

Resistance to low pH is one of the major selection for probiotic strains (Cakir, 2003). LAB are indigenous habitants of human gastro intestinal tract and thought to among the dominant colonies of the small intestine (Marco *et al.*, 2006). To reach the small intestine ,they have to pass through stomach. Although in the stomach ,pH can be as low as in vitro assay pH 3.0 have been preferred . For selection of strain resistant to low pH 3.0 was used .The time that takes during digestion in stomach is 3 hours, so isolates were tested for resistance to pH 3.0 during 3.0 h. Figure 1 indicates that eight of eleven *lactobacillus* isolates were resistance to pH 3.0 during three hours.

Isolates S1, S2, S3, S4, S5, S6, S7, S8, B.M. were very stable in pH 3.0 which means that isolates are able to survive in this pH value the other *lactobacillus* isolates are able to tolerates pH 3.0 for one hour but they more sensitive to low Ph. In agreement with the present results Martin *et al.* (2004) isolated three *lactobacillus spp.* from human milk and were identified as *L. gasseri* and *L. fermented*. They survived Low pH and in gastrointestinal environment the strains especially *L. casei* result showed that these isolates can be used as potential probiotic strains. Our results were also similar to that reported by Maragkoudakis *et al.* (2005) who tested that 29 *Lactobacillus* strains of

dairy origin for their probiotic potential. All of the examined strains were resistant to pH 3.0 during 3h most of them lost their viability in one hour in pH 1. Tolerance of probiotic *lactobacillus spp.* isolated in the present study are in accordance with previous results (Jensen *et al.*, 2012; Hurtado *et al.*, 2012; Abioue *et al.*, 2012).

### 2.2.Tolerance against Bile.

All *lactobacilli* isolates were tested for bile salt tolerance The strains, resistant to low pH became 8 isolates , were screened for their ability to tolerate the bile salt Strains were detected in 0.3% during 3hours ( Table7).

**Table 7: Tolerance of *lactobacillus spp.* isolates against 0.3% bile – cfu, values**

	CFU/ml				
CFU/ti me	B.M.	S8	S1	S4	ATCC78 30
0h	196	190	205	200	221
1h	189	187	170	185	183
2hrs	188	180	175	183	189
3 hrs	178	179	179	180	181

These results indicated that all isolates can tolerates the bile salt 0.3%concentration. This in agreement with Darilmaz, and and Beyatli (2012) who reported that acid tolerance of isolated

*Lactobacillus* spp. varied at different pHs. Such difference was however lower between isolated Lactobacilli and *L. plantarum*. The isolated Lactobacilli were bile salt tolerant. Bile tolerance is essential for probiotic strains to colonize the small intestine (Huang, 2004) With the development of new delivery systems and the use of specific foods, Evidence clearly demonstrates that acid sensitive strains can be buffered through the Stomach. However, to exert a positive effect on the health and well-being of a host, probiotics need to colonize and survive in the small intestine (Leverrier, 2005) and it is the condition of this environment that may in fact be the essential selection criteria for future probiotics. Similarly Abriouel *et al.* (2012) reported that *Lactobacillus* strains isolated from fermented

table olive tolerated 2% bile salt. Jensen *et al.* (2012) reported that *Lactobacillus* spp. tolerate gastric juice well with no reduction in viability and *L.pentoses* and *L.sakei* strains lost viability over 180 min. similarly Vitali *et al.* (2012) determined the probiotic potential of large number of lactic acid bacteria isolated from fruit and vegetables, the result indicated that 35 % of LAB. maintained high cell densities and survived gastric and intestinal conditions.

### 2.3. Antimicrobial Activity

The selected eight isolates were tested for their antimicrobial activity against clinical isolates. For this purpose, strains were tested against *Salmonella thyphimurium*, *Escherichia coli*, *Micrococcus* spp., *Staphylococcus* spp. Result shown in Table 8.

**Table 8. Antimicrobial activity of lactobacillus isolates**

No. of isolate	Diameter of inhibition zone (mm)			
	<i>E. coli</i>	<i>Salmonella thyphimurium</i>	<i>Micrococcus</i>	<i>Staphylococcus</i>
S1	14	13	13	14
S2	14	15	15	15
S3	13	12	12	14
S4	15	14	14	17
S5	18	10	20	17
S6	19	9	17	20
S7	20	20	17	22
S8	18	17	18	25
B.M.	21	18	22	25

Table 8 showed that all of the isolates have antibacterial effect on the tested microorganisms. The tests were applied two times and the averages of diameters of zones were given. From the result we found that B.M. has the most potent antimicrobial activity isolate followed by S5 then S6, S8 and the lowest antimicrobial activity was found in S1, S2, S3 LAB. This may be due to production of bacteriocins which are peptides with bactericidal activity usually against strains of closely related species (Abriouel *et al.*, 2012). Bacteriocins may enhance survival of LAB in complex ecological systems that focused on prevention of growth of harmful bacteria in the fermentation and preservation of dairy products. It is more interesting with respect to probiotics that individual strains may inhibit growth of or adhesion of pathogenic microorganisms by secreted products, and not merely an effect of acidic pH (Atta, 2009.) Also *Lactobacillus* isolates obtained from fermented millet drink are more effective than isolates from cow milk as regards their antagonism or inhibition (Shehata, 2012). An important property of probiotic strains is their Antagonistic activity against pathogenic bacteria. Propionic acid bacteria can produce Antimicrobial substances capable of inhibiting the growth of pathogenic and spoilage microorganisms. Propionic acid, acetic acid, and

diacetyl in addition to the antimicrobial peptides are included among these compounds (Havenaa, 1992). similar result on antagonistic activity of LAB. was reported by several investigation and largely documented (Abriouel *et al.*, 2012). Also all LAB. Isolated from raw fruits and vegetables inhibited *E. coli* isolated from human sources. Vitali *et al.* (2012) isolated strains of different species (90 isolates) from olives produced antimicrobial substances which were active against a number of potentially pathogenic gram negative and gram positive bacteria such as *S. aureus*, *E. facalis*, *Salmonella enterica*. Also another study revealed that bacteriocin produced by *Lactobacillus* isolated from chicken showed inhibition against a number of food-borne pathogens, such as *L.monocytogenes*, *S.aureus* and *Salmonella* without inhibiting LAB (Messaoudi., 2012).

### 3. Safety assessment of probiotic lactobacillus spp.

#### 3.1. Enzymatic Activities of lactobacillus isolates

All isolates were screened to enzymatic activity to detect any unfavorable enzyme like the carcinogenic enzyme,  $\beta$ -glucuronidase and presence of beneficial enzymes. Enzyme Production by isolates was an important criterion in its selection, because carcinogenic enzymes such as  $\beta$ -glucuronidase can be produced by microorganisms. When carcinogenic substances such as benzo(a) pyrene enter the human

body, their poisonous effects are counteracted because of conjugation with glucuronic acid in the liver. If this conjugated product is excreted with bile acid in the intestine, cleavage by  $\beta$ -glucuronidase can liberate these substances to become toxic once again. Result recorded in table 8 indicated that all isolates did not produce the carcinogenic enzyme,  $\beta$ -glucuronidase, whereas beneficial was produced, which is beneficial for lactose intolerance. These

enzymes include leucine arylamidase, cystine arylamidase, acid phosphatase, naphthol-AS-BI-phosphohydrolase,  $\alpha$ -galactosidase,  $\beta$ -galactosidase,  $\alpha$ -glucosidase,  $\beta$ -glucosidase, and N-acetyl- $\beta$ -glucosaminidase. These results were in agreement with **Chang-Won *et al.* (2008)**. Similarly,  $\beta$ -galactosidase was found in *Lactobacillus* isolated from fermented oil as reported by **Abriouel *et al.* (2012)**.

**Table 9: Enzyme activity of isolated *Lactobacillus* spp.**

Enzyme	S1	S2	S3	S4	S5	S6	S7	B.M.	S8
Control	0	0	0	0	0	0	0	0	0
Alkaline phosphatase	0	0	0	0	0	0	0	0	0
Esterase	0	0	0	0	0	0	0	0	0
Esterase lipase	0	0	0	0	0	0	0	0	0
Lipase	0	0	0	0	0	0	0	0	0
Leucine arylamidase	2	2	2	2	2	2	2	3	2
Valine arylamidase	0	0	0	0	0	0	0	0	0
Cystine arylamidase	1	1	1	1	2	1	1	2	1
Trypsin	0	0	0	0	0	0	0	0	0
$\alpha$ -Chymotrypsin	0	0	0	0	0	0	0	0	0
Acid phosphatase	2	2	2	2	2	2	2	2	2
Naphthol-AS-BI-phosphohydrolase	5	5	5	5	5	5	5	5	5
$\alpha$ -Galactosidase	2	2	2	2	2	2	2	2	2
$\beta$ -Galactosidase	5	5	5	5	5	5	5	5	5
$\beta$ -Glucuronidase	0	0	0	0	0	0	0	0	0
$\alpha$ -Glucosidase	2	2	2	2	2	2	1	2	1
$\beta$ -Glucosidase	2	2	2	2	2	2	2	2	2
N-Acetyl- $\beta$ -glucosaminidase	3	3	3	3	3	3	3	3	3
$\alpha$ -Mannosidase	0	0	0	0	0	0	0	0	0
$\alpha$ -Fucosidase	0	0	0	0	0	0	0	0	0

Score 0 = 0 nmol, Score 1 = 5 nmol, Score 2 = 10 nmol, Score 3 = 20 nmol, Score 4 = 30 nmol, Score 5  $\geq$  40 nmol.

### 3.2. Testing for resistance to antibiotics

All isolates were tested for antibiotics and show different degree of resistance which was also observed by **Herreros *et al.* (2005)**. Various reports indicate that LAB are normally resistant to the principal types of antibiotics, such as  $\beta$ -lactam, cephalosporin, aminoglycosides, quinolone, imidazole, nitrofurantoin and fluoroquinolones (**Halami *et al.*, 2000**). Transfer of resistance to antimicrobial substances is an essential mechanism in LAB if they are to adapt and survive in specific environments. Among the resistance mechanisms in use, enzymic inactivation of the antibiotics, restricted import of antibiotics, active export of antibiotics or target modification may be highlighted (**Davies, 1997**). *Lactobacilli* are generally resistant to aminoglycosides (**Belletti *et al.*, 2009**). Vancomycin resistance is thought to be intrinsic, since nearly all the strains are constitutively resistant to low levels of the antibiotic (**Roland *et al.*, 1992**).

### 3.3. Hemolytic activity of *Lactobacillus* spp.

All isolates were tested for hemolytic activity and gave negative result with this test confirming that LAB are safe for human use (**Kumar and Murugalatha, 2012**). This result agrees with **Sandra *et al.* (2012)** who reported that none of the fifteen putative probiotics was found to be B-hemolytic.

In conclusion the present study showed that human milk, yogurt and raw milk are sources of potential probiotic strains of LAB and the isolates meet several function features to be considered as suitable probiotic for application in food fermentation and the isolated bacteria are able to tolerate acidic medium and bile salt with favorable enzymatic activity and no hemolytic activity so we consider it great potential probiotic character and safe for human use.

#### References:

Abriouel H., Benomar N., Cobo A., Caballero N., Fuentes M.A., Pérez-Pulido R., Gálvez A. (2012). Characterization of lactic acid bacteria from

- naturally-fermented Manzanilla Aloreña green table olives \* Food Microbiology 32: 308-316
- Atta H.M. (2009). Application of Biotechnology for Production, Purification and Characterization of Peptide Antibiotic Produced by Probiotic *Lactobacillus plantarum*, NRRL B-227 Global Journal of Biotechnology & Biochemistry. 4 ((2): 115-125.
- Beasley S. (2004). Isolation, identification and exploitation of lactic acid bacteria from human and animal microbiota. PhD thesis, Helsinki: University of Helsinki
- Begley M., Gahan C.G.M. and Hill C. (2005). The interaction between bacteria and bile. FEMS Microbiology Reviews 29: 625–651.
- Belletti N., Benedetta-bottari M.G., Tabaneli G and Gardini A.F. (2009). Antibiotic Resistance of *Lactobacilli* Isolated from Two Italian Hard Cheeses Journal of Food Protection, 72(No. 10): 2162-2169.
- Briugs M. (1953). The Classification of Lactobacilli by means of Physiological Tests J. gen. Microbiol. 9: 234-2444.
- Brinner D.J., Staley J.T., Kreig N.R. (2001). Classification of procaryotic organisms and the content of bacterial speciation In: BOONE dr,castenholz RW (eds, garrity GM (editor in chief)bergey's manual of sydtematic bacteriology 2<sup>nd</sup> edn,voll,thearchaea and thgedeeply branching and phototrophic bacteria
- Çakır İ. (2003). Determination of some probiotic properties on *Lactobacilli* and *Bifidobacteria*. Ankara University Thesis of Ph.D.
- Chang-Won K., and Paik H-D. (2008). Screening of *Lactobacilli* Derived from Chicken Feces and Partial Characterization of *Lactobacillus acidophilus* A12 as Animal Probiotic J. Microbiol. Biotechnol. 18(2): 338-342.
- Cotter P.D., Hill, C. (2003). Surviving the acid test: responses of Gram-positive bacteria to low pH. Microbiology and Molecular Biology Reviews 67, 429–453
- Cullimore R. (2008). Practical atlas for bacterial identification .p. 91 chapter gram positive rods.
- Darilmaz D.O. and Beyatli Y. (2012) Acid-bile, antibiotic resistance and inhibitory properties of propionibacteria isolated from Turkish traditional home-made cheeses Anaerobe 18 122-127
- Dave R. I. and Shah N. P. (1996). Evaluation of media for selective enumeration of *Streptococcus thermophilus*, *Lactobacillus delbrueckii ssp. bulgaricus*, *Lactobacillus acidophilus* and *Bifidobacterium spp.* J. Dairy Sci. 79:1529–1536.
- Davies J.E. (1997). Origins, acquisition and dissemination of antibiotic resistance determinants. In: Chadwick, D.J., Goode, J. (Eds.), Antibiotic Resisance. Origins, Evolution, Selection and Spread. Wiley, Chichester, pp. 15–27.
- Dušková M., KateřinaKšicová O.Š., ZbyněkZdráhal , RenátaKarpišková, (2012). Identification of *lactobacilli* isolated from food by genotypic methods and MALDI-TOF MS. International Journal of Food Microbiology 159: 107-114.
- Ezendam, J., Loveren, H. (2006). Probiotics: immunomodulation and evaluation of safety and efficacy. Nutrition Reviews 64:1–14.
- Hammes W.P. and Hertel, C. (2006). The genera *Lactobacillus* and *Carnobacterium*, In: Dworkin, M., Falkow, S., Rosenberg, E., Schleifer, K.-H., Stackebrandt, E. (Eds.), third ed. The Prokaryote, vol.4. Springer, New York, NY, pp. 320–403.
- Halami, P.M., Chandrashekar, A., Nand, K., 2000. *Lactobacillus farciminis* MD, a newer strain with potential for bacteriocin and antibiotic assay. Lett. Appl. Microbiol. 30, 197–202.
- Havenaar, R., Brink N.G., Huisin'tVed J.H.J. (1992). Selection of strains for probiotics use. In: Fuller R, editor. Probiotics: the scientific basis. London: Chapman and Hall; p. 210-24.
- Herreros, M.A., Sandoval H., González L., Castro J.M., Fresno J.M. and Tornadijo M.E. (2005). Antimicrobial activity and antibiotic resistance of lactic acid bacteria isolated from Armada cheese (a Spanish goats' milk cheese). Food Microbiology, 22: 455–459.
- Huang, Y. and Adams M.C. (2004). *In vitro* assessment of the upper gastrointestinal tolerance of potential probiotic dairy propionibacteria. Int J Food Microbiol; 91:253-60.
- Hurtado, H.,C.R., Bordons A., Rozès N., (2012). Lactic acid bacteria from fermented table olives. Food Microbiology 31: 1-8.
- Jensen H., Grimmer S. , Naterstad K., Axelsson L. (2012), In vitro testing of commercial and potential probiotic lactic acid bacteria International Journal of Food Microbiology (153): 216-222.
- Karimi R., Mortazavian A.M., Amiri-Rigi A. (2012). Selective enumeration of probiotic microorganisms in cheese Food Microbiology 29: 1-9
- Kumar M. (2012), Isolation of *Lactobacillus plantarum* from cow milk and screenin for the presence of sugar alcohol producing gene. Journal of Microbiology and Antimicrobials. 4 (1): 16-22.
- Lebeer S., Vanderleyden J., De Keersmaecker, S.C. (2008). Genes and molecules of lactobacilli supporting probiotic action. Microbiology and Molecular Biology Reviews 72, 728–764.
- Lebeer S., Vanderleyden J., De Keersmaecker S.C. (2010). Host interactions of probiotic bacterial surface molecules: comparison with commensals and pathogens. Nature Reviews Microbiology 8, 171–184.
- Leverrier P., Fremont Y., Rouault A., Boyaval P. and Jan G. (2005). In vitro tolerance to digestive stresses of propionibacteria: influence of food matrices. Food Microbiol; 22:11-8.
- Leclerqu R., S.D.-M., Duval J. and Courvalin P., (1992). Vancomycin Resistance Gene vanC Is Specific to *Enterococcus gallinarum* Antimicrobial

- agents and chemotherapy, 36(9): 2005–2008. .
- Liu W., Qiuhua Bao, Jirimutu, Qing M., Siriguleng, Chen X., Sun T., Meihua Li, Zhang J., Jie Yu, Bilige M., Tiansong Sun T, and Zhang H. (2012). Isolation and identification of lactic acid bacteria from Tarag in Eastern Inner Mongolia of China by 16S rRNA sequences and DGGE analysis *Microbiological Research* 167: 110– 115.
- Lleo M.M., Tafi M.C., Canepari P. (1998). Non culturable *Enterococcus faecalis* cells are metabolically active and capable of resuming active growth *Syst Appl Microbiol.* 21(3):333-9.
- Maragkoudakis P.A., Zoumpopoulou G., Miaris C., Kalantzopoulos G., Pot, B., Tsakalidou, E. (2005). Probiotic potential of *Lactobacillus* strains isolated from dairy products. *International Dairy Journal* 16:189-199.
- Marco M.L., Pavan S., Kleerebezem M. (2006). Towards understanding molecular modes of probiotic action. *Current Opinion in Biotechnology* 17: 204–210.
- Martin R., Langa S., Reviriego C., Jimenez E., Marin L.M. Olivares M., Boza J., Jimenez J., Fernandez L., Xaus J. and Rodriguez J.M. (2004). The commensal microflora of human milk: New perspectives for food bacteriotherapy and probiotics. *Trends in Food Science & Technology* 15: 121-127.
- Messaoudi S., Kergourlay G., Dalgalarondo M., Choiset Y, Mir-hoseini M. (2012). Study of effect of nisin and producer bacteria of nisin on *Listeria monocytogenes* and *Bacillus cereus* [Isfahan: University of Isfahan]
- Mir-hoseini M. (2004). Study of effect of nisin and producer bacteria of nisin on *Listeria monocytogenes* and *Bacillus cereus*. Isfahan: University of Isfahan.
- Mohania, D., Nagpal, R., Kumar, M., Bhardwaj, A., Yadav, M., Jain, S., Marotta, F., Singh, V., Parkash, O., Yadav, H. (2008). Molecular approaches for identification and characterization of lactic acid bacteria. *Journal of Digestive Diseases* 190–198.
- National Committee for Clinical Laboratory Standards (2000). Performance standards for antimicrobial disk susceptibility tests. Villanova, PA: NCCLS, Approved Standard: M2-A7. 7th ed.
- Nour-Eddine K.M., .K. (2006). *In-vitro* pre-selection criteria for probiotic *LACTOBACILLUS PLANTARUM* strains of fermented olives origin. *International Journal of Probiotics and Prebiotics.* 1. 27-32.
- Oguntoyinbo F.A and ,Narbad, A. (2012) Molecular characterization of lactic acid bacteria and in situ amylase expression during traditional fermentation of cereal foods. *Food Microbiology* 2012.31 : 254-262.
- Owusu- J.K., , Fortune Akabanda , Dennis S. Nielsen , KwakuTano-Debrah, Richard L.K. Glover , Lene Jespersen (2012). Identification of lactic acid bacteria isolated during traditional fura processing in Ghana *Food Microbiology* 32 (2012) 72-78.
- Patil, m.m., and Ajay pal, T.(2010). Isolation and characterization of lactic acid bacteria from curd and cucumber , *Indian Journal*, 9: 166-172.
- Phillip, S., Mtshali, B.D., Maret du Toit (2012) *Identification and characterization of Lactobacillus florum strains isolated from South African grape and wine samples* *International Journal of Food Microbiology* 153:106-113.
- Prescott, L.M. and Harley ,J.P. (2002). Appendix h: Reagents, solutions ,stains ,and tests .in laboratory exercises in microbiology. 5th ed. New york :mcgraw hill.
- Ranadheera C.C.S., Evans C.A C.A., Adams M .C .M.C. and Baines S. K. S.K. (2012). Probiotic viability and physico-chemical and sensory properties of plain and stirred fruit yogurts made from goat's milk. *Food Chem* 135(3):1411-8.
- Rattanachaikunsopon, P., Phumkhachorn P (2010). Lactic acid bacteria: Their antimicrobial compounds and their uses in food production *Ann Biol Res.*; 1:218-28.
- Roos, S., Engstrand L., Jonsson H. (2005). *Lactobacillus gastricus sp. nov., Lactobacillus antri sp. nov., Lactobacillus kalixensis sp. nov. and Lactobacillus ultunensis sp. nov.*, isolated from human stomach mucosa. *International Journal of Systematic and Evolutionary Microbiology* 55:77-82.
- Sandra, T. S., Janine Barlow, Adele Costabile , Glenn R. Gibson and Ian Rowland (2012) In vitro evaluation of the antimicrobial activity of a range of probiotics against pathogens: Evidence for the effects of organic acids *J. Anaerobe* 18 530-538.
- SCAN (2000): Report of the Scientific Committee on Animal Nutrition on the Safety of Use of *Bacillus* Species in Animal Nutrition. European Commission Health & Consumer Protection Directorate-General. <http://europa.eu.int/comm/food/fs/sc/scan/out41.pdf>
- Shehata A. (2012). Molecular Identification Of Probiotics *Lactobacillus* Strain isolates by: Amplified Ribosomal DNA Restriction Analysis (ARDRA). *Science Journal of Microbiology*, ID SJMB-175, 8 Pages, 2012. doi:10.7237/sjmb/175.
- Vitali B., Minervini G., Rizzello C.G., Spisni E., Simone Maccaferria S., Brigidi P., Gobbetti M and Di Cagno R. (2012). Novel probiotic candidates for humans isolated from raw fruits and vegetables. *Food Microbiology*.31: 116-125.
- Wang, J., Chen, X., Liu, W., Yang, M., Zhang, H., (2008). Identification of *Lactobacillus* from koumiss by conventional and molecular methods. *European Food Research and Technology* 227, 1555–1561.

## Perception of Food Safety and Prevalence of *Staphylococcus aureus* and *Salmonella* species Carriers among Fayoum University Food handlers

Rasha H. Bassyouni<sup>1</sup>, Naglaa El-Sherbiny<sup>2</sup>, Enas H. Hefzy<sup>1</sup>, Ahmed- Ashraf Wegdan<sup>1\*</sup>

<sup>1</sup>Medical Microbiology and Immunology Department, Faculty of Medicine, Fayoum University.

<sup>2</sup>Public Health Department, Faculty of Medicine, Fayoum University.

[ashrafwegdan@yahoo.com](mailto:ashrafwegdan@yahoo.com); [rashabassyoni@yahoo.com](mailto:rashabassyoni@yahoo.com)

**Abstract:** Foodborne diseases encompass a wide spectrum of illnesses especially in developing countries. **Aims:** This study aimed to investigate food handlers' knowledge, attitude and practices about food safety in four restaurants in Fayoum University and to assess the carrier rate of *S. aureus* and *Salmonella* spp. also determination of the total viable count, and level of hand contamination with *E. coli*, other members of Enterobacteriaceae as well as other aerobic Gram-negative bacteria. **Methods:** A cross-sectional, descriptive, observational study was conducted among 209 Fayoum University food handlers serving four main kitchens at the University. The food handlers' interviewed using a pre-tested questionnaire included three main topics regarding knowledge, attitude and practices of food safety. Data collectors observed food handlers' to collect information on food preparation, handling and the sanitary condition of the facilities. Microbiological samples were collected from 158 healthy food handlers including swabs from throat, each nostril, stool and urine samples followed by culturing on proper media, also determine of the total bacterial count and hand contamination by fingerprint culture technique. **Results:** About 90% of food handlers have good knowledge, between 30.1% and 55% found to have good practice. Carrier rate of *S. aureus* was 17.1%. The total viable bacterial count exceeds 300 CFU/hand in 37.3%. Out of 158 food handlers, 57 (36.1%) of them had contaminated hand with *S. aureus*, 26 (16.5%) with Enterobacteriaceae and 6 (3.8%) with *Pseudomonas* Spp.. All stool and urine samples were negative for *Salmonella* spp. **Conclusion:** To achieve a good level of food safety, pre Employment investigations and training as well as continuous monitoring of food handlers should be implemented.

[Rasha H. Bassyouni, Naglaa El-Sherbiny, Enas H. Hefzy, Ahmed- Ashraf Wegdan . **Perception of Food Safety and Prevalence of *Staphylococcus aureus* and *Salmonella* species Carriers among Fayoum University Food handlers.** *Life Sci J* 2012;9(4):2934 -2940]. (ISSN: 1097-8135). <http://www.lifesciencesite.com>. 429

**Key words:** Food handlers, KAP study; *S. aureus* ; *Salmonella*

### 1. Introduction

Foodborne diseases encompass a wide spectrum of illnesses especially in developing countries. They are growing public health problem, costly yet preventable worldwide. They are the result from ingesting contaminated foodstuffs, by many different microbes or pathogens, chemical hazards or other harmful toxins that present in food for example, poisonous mushrooms (**Kibret and Abera, 2012**). Occurrence of foodborne illness is a clinical health problem causing economic losses related to lower work productivity, hospitalization, and other health care expenses (**Dharod et al., 2009**).

Food safety is a scientific discipline describing handling, preparation and storage of food in ways that prevent foodborne illness. This includes a number of routines that should be followed to avoid potentially severe health hazards. Food service establishments are sources of food borne illnesses and food handlers contribute to food borne illness (**Teferi et al., 2012**).

The World Health Organization (WHO) estimated that in developed countries, up to 30% of the population suffers from food borne diseases each

year, whereas in developing countries up to 2 million deaths are estimated per year (**WHO, 2007 a&b**). Unsafe, disregard hygienic measures of food and faulty food handling practices may enable pathogenic bacteria to come into contact with food, multiply in sufficient numbers to cause many acute and life-long diseases, ranging from diarrheal diseases to various forms of cancer (**Clayton et al., 2002**). Lacking personal hygiene among food handlers is one of the most commonly reported practices contributing to food-borne illness with poor hand and surface hygiene (**Cogan et al., 2002; Collins, 2001**). Hand-washing, a simple and effective way to cut down on cross-contamination, is all too often forgotten (**Rippel, 2002**).

The transmission of enteric-related pathogenic microorganisms via the hands of food handlers continues to be a problem in the food industry (**Barza, 2004**). *Staphylococcus aureus*, *Escherichia coli* and *Salmonella* spp. survive on hands and surfaces for hours or even days after initial contact with the microorganisms (**Kusumaningrum et al., 2002**). These microbes have been associated with food-borne illness for decades and there is no doubt



that they, together with members of amongst others the genera *Listeria*, *Campylobacter*, *Bacillus* and *Clostridium* are the cause of illness and even death to many people each year, at immeasurable economic cost and human suffering (Borch & Arinder, 2002).

A microbial indicator is a microorganism or group of microorganisms that is indicative of the possible presence of pathogens and the detection and enumeration of indicator organisms are widely used to assess the efficacy of sanitation programs (Brown *et al.*, 2000; Ingham *et al.*, 2000; Moore & Griffith, 2002). Indicator organisms associated with hygiene practices include, total viable counts, total coliforms, *E. coli*, members of the family Enterobacteriaceae and *S. aureus* (Department of Health, 2000). The presence of *S. aureus* in food indicates flaws during food manipulations. For this reason most sanitary norms require the detection of *S. aureus* carriers (Figueroa *et al.*, 2002).

This study aimed to investigate food handlers' knowledge, attitude and practices about food safety and explore the sanitary conditions of food service establishments in four restaurants in Fayoum University. The most important aim of the present study was to assess the carrier rate of *S. aureus* and *Salmonella* spp. among food handlers and determine the total viable count, and level of hand contamination with *E. coli*, other members of Enterobacteriaceae as well as other aerobic Gram-negative bacteria.

## 2. Subjects and Methods:

A cross-sectional, descriptive, observational study was conducted among 209 Fayoum University food handlers' serving four main kitchens at the University campus selected by purposive sampling. Data collectors and supervisor were oriented about the purpose of the study.

The food handlers' interviewed using a pre-tested, Arabic structured closed questionnaire with an inclusion criterion of being a staff in Fayoum University kitchens. While the exclusion criteria were refusal to participate in the study. The questionnaire included three main topics regarding knowledge, attitude and practices of food safety containing thirty questions, ten about personal hygiene, nine related to kitchen equipment's hygiene and eleven considered with the usage of proper healthy food items. Data collectors observed food handlers' while they were performing their jobs to collect information on food preparation, handling and the sanitary condition of the facilities.

### Microbiological sampling and processing

Microbiological samples were collected from 158 healthy food handlers; after given written

consent for samples collection; 89 were males (56.3 %) and 69 were females 43.7%).

### Determination of *S. aureus* carrier rate:

To determine *S. aureus* carriers, swabs from throat and each nostril from each subject were cultured onto Columbia blood agar as well as manitol salt agar (Oxoid LTD, Basingstoke, England), Plates were incubated for 24h at 37°C under aerobic conditions. *S. aureus* was identified using standard microbiological procedures.

### Determination of total bacterial count and hand contamination

Fingerprint technique was used to determine the total bacterial count and hand contamination onto a Columbia blood agar plate (one plate / 5 fingers) (Oxoid LTD, Basingstoke, England). Total bacterial count was recorded as the number of colony forming units (CFU)/hand. Plates were incubated at 37°C under aerobic conditions, and colony-forming units (CFUs) were counted after 48 hrs. The maximum count was 300 CFUs; beyond this figure, it was considered that there was a confluence (Lucet *et al.*, 2002). Potential pathogenic bacteria from transient flora (i.e. *Staphylococcus aureus*, Enterobacteriaceae, aerobic Gram-negative bacteria) were identified using standard microbiological techniques.

### Determination of *Salmonella* spp. carrier rate:

To determine *Salmonella* carriers as well as presence of *Shigella* spp. In stool, stool and urine samples were collected from each subject. Stool samples were cultured in selenite broth, incubated at 37°C then subcultured after 24hrs on MacConkey and Xylose deoxycholate (XLD) agar (Oxoid LTD, Basingstoke, England) while urine samples were cultured on MacConkey, XLD and CLED agar (Oxoid LTD, Basingstoke, England). Any non-lactose fermented Gram-negative Bacilli were tested for oxidase production. Oxidase-negative Gram-negative Bacilli were further identified by Microbact (12A) Gram-negative identification system (Oxoid, Basingstoke, UK) to identify *Salmonella* and *Shigella* spp.

### Data entry and statistical analysis:

Data were collected, coded and analyzed using SPSS software version 15 under windows 7, simple descriptive analysis in the form of percentage distribution, were done.

### Ethical Consideration:

This study was reviewed and approved by the Faculty of Medicine Research Ethical Committee, and a waiver of consent form was approved, as we used an anonymous self-administered questionnaire with no private or sensitive information.

## 3. Results:

**Socio-demographic data:** more than half of the food handlers were males 118 (56.4%) and 91 (43.5%) were females with an age ranging between 18 and 55 years of age with Mean age  $\pm$ SD was  $27.43 \pm 7.72$  years. Regarding level of education 147 (70.3%) of the food handlers completed primary school, 39 (18.6%) were completed secondary school and 23 (11%) had high education.

**Food hygiene knowledge and hand hygiene practices of food handlers:** There was no frequent food hygiene training received by food handlers but they acquire knowledge of food preparation through observation of the senior's staff. The majority of the food handlers appear to have excellent knowledge of food hygiene regarding what to do as almost 97.6% were know that they must do frequent hand wash during food preparation also 95.2% cut their nail and

90% concerned about their personal cleanliness 88% were covered hair and 91.3% stay at home during illness also 69.7% knew that they must perform an annual examination.

Hand washing with soap is a practice that has long been recognized as a major barrier to the spread of disease in food preparation. As hand hygiene is not always carried out effectively, both enteric and respiratory diseases are easily spread in these environments. The observational results of the investigator showed that they had poor practice by wearing hand jewelries while preparing food 115 (55%), they don't wash their hand frequently only at the beginning of the food preparation with minimal personal variation 63 (30.1%), but they were washing their hand during different activities in the kitchen Figure (1).

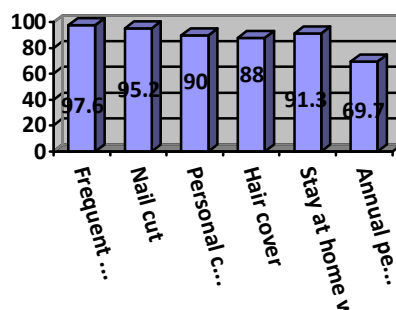


Figure (1) Food handlers knowledge & practice related to food safety

**As regards the questions related to kitchen equipment's cleanliness practices:** by using clean utensils, clean the utensils with hot water and detergent clean the sink to avoid contamination of the

food and cover the garbage pot to prevent transmission of infection to the food are applied by more than 92%. These important findings were demonstrated in the Figure (2)

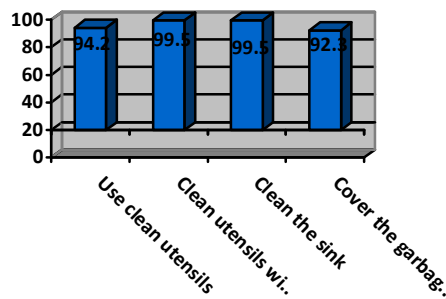


Figure (2) Kitchen cleanliness

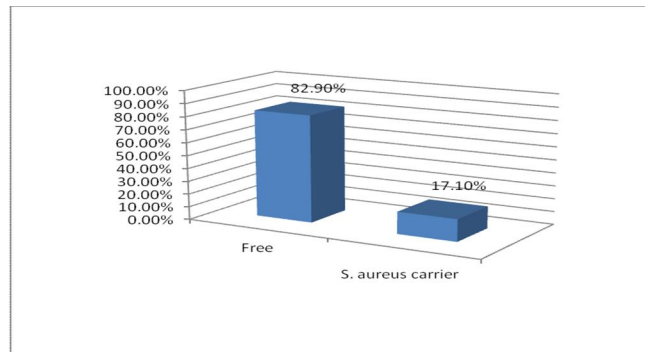
One of the most important topics in the questionnaire was the proper use of fresh healthy food items as usage of (100%) fresh vegetables, fruits and intact food cans, (100%) apply proper temperature for cooking and (97.4%) check

refrigerator temperature daily and lastly (99.1%) cover the pots after finishing cooking.

**Microbiological results:** Among the 158 healthy food handlers (89 males (56.3%) and 69 females (43.7%)), the overall prevalence of nasal

carriage of *S. aureus* was 27(17.1%), 5 (3.2%) of

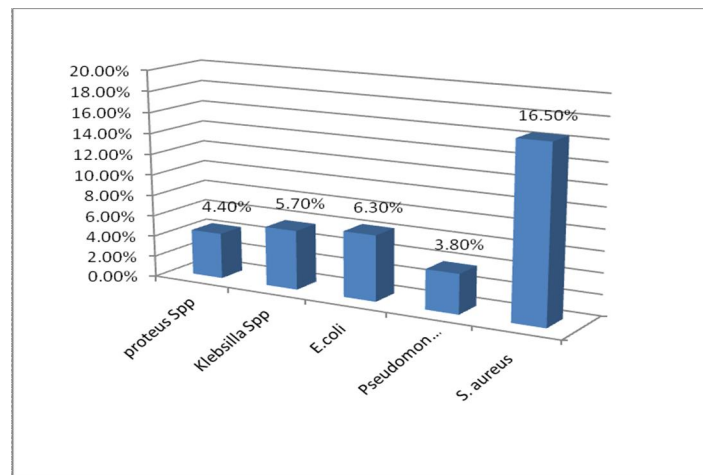
them were also positive for throat swab (Figure 3).



**Figure (3): prevalence of nasal carriage of *S. aureus* among food handlers.**

The total viable bacterial count exceeds 300 CFU/hand in 59 (37.3%) of them. Although 99/158 (62.7%) of food handlers have total viable count below 300 CFU/hand which can be negligible in most cases (Lucet *et al.*, 2002), 43 (27.2%) of them have contaminated hand with at least one type of pathogenic bacteria. Nineteen (12%) out of 158 food handlers showed mixed pattern of colonization by 2 or more pathogenic bacterial isolates, while 49/158

(31%) yielded a single isolate. Out of 158 food handlers, the hands of 57 (36.1%) of them were contaminated with *S. aureus*, 26 (16.5%) with Enterobacteriaceae and 6 (3.8%) with *Pseudomonas Spp.* Among Enterobacteriaceae, *E.coli* represent 6.3% (10/158), *Klebsilla Spp.* 5.7% (9/158) and *proteus Spp.* 4.4% (7/158) (Figure 4). All stool and urine samples were negative for *Salmonella* and *Shigella* spp.



**Figure (4): Prevalence of hand contamination of pathogenic organisms among food handlers.**

#### 4. Discussion:

The results of this study revealed that although there was no frequent training of food hygiene, yet they had an excellent knowledge related to food safety but they did not translate their knowledge into practice in spite of positive responding of food handlers for food safety related questions. Our results were in coincidence with Kibret and Abera (2012) results as they concluded that poor hygienic practices by food handlers coupled with poor sanitary conditions in food and drink establishments can contribute to foodborne illnesses.

Green *et al.* (2006) documented that improvement of food worker hand washing practices is critical to the reduction of foodborne illness and was dependent upon a clear understanding of current hand washing practices, hand washing and glove use were more likely to occur in conjunction with food preparation than with other activities. He also reported that only 32% of the workers were attempted to wash their hand frequently during food preparation this was agreement with our results as 30.1% washing their hand during different activities in the kitchen.

In this study, nasal and throat swab culture of 158 food handlers serving four restaurants at Fayoum University had been investigated for the presence of *S. aureus*. The rate of isolation of *S. aureus* from the nasal cultures in our study 27 (17.1%) was found to be similar to those reported by **Teferi and his colleagues (2012)** who conducted a cross sectional study among food handlers working in University of Gondar student's cafeterias and found that 20.5% food handlers were positive for nasal carriage of *S. aureus*. Also **Ahmed et al. (2010)** reported that the carriage rate of *S. aureus* among food handlers in the Omdurman area of Sudan was 21.6%. Other studies screened nasal carriage of *S. aureus* among restaurant workers in Kwit and Makkah cities and reported carrier rate of *S. aureus* to be 26.6% and 20.8% respectively (**Bustan et al.,1996; Asghar et al., 2006**). However, our finding was found to be higher than the rate 69(0.77%) obtained from a study conducted in Turkey **Gunduz et al., 2008**) and much lower than the findings reported in Brazil (**Souza and Santos, 2009; Acco et al.,2003**) and Botswana (**Loeto et al.,2007**) as 30%, and 44.6%; respectively. Nasal carriage rates reported by several workers vary and the variation has been attributed to the ecological differences of the study population.

It is very important to note that although *S. aureus* can cause severe infections it may also be as a member of the normal flora of the nasal cavity (**William, 1993**). If by chance, a food handler carries, an enterotoxin producer *S. aureus* he/she may contaminate the food and causes staphylococcal food poisoning outbreak in the population.

Microorganisms can be transferred to the hands in the process of handling food and through poor personal hygiene resulting in the hands being heavily contaminated with enteric pathogens (**Lues and Tonder, 2007**). Fecal coliforms can be easily removed by hand washing (**Jumaa, 2005**) and their presence indicates fecal contamination and food handlers are not taking enough care in hand hygiene (**Aycicek et al., 2004**). Also staphylococci distributed in the environment and strains present in the nose often contaminate the back of hands, fingers and face, and nasal carriers could therefore easily become skin carriers (**Lues and Tonder, 2007**). In our study the total viable bacterial count exceeds 300 CFU/hand in 59 (37.3%) of tested food handlers. Moreover 43 (27.2%) of the 99 (62.7%) food handlers who have acceptable count their hands were contaminated with at least one type of pathogenic bacteria. Nineteen (12%) out of 158 food handlers showed mixed pattern of colonization by 2 or more pathogenic bacterial isolates, while 49/158 (31%) yielded a single isolate. Out of 158 food handlers, the hands of 57 (36.1%) of them were contaminated with

*S. aureus*, 26 (16.5%) with Enterobacteriaceae and 6 (3.8%) with *Pseudomonas Spp.* Among Enterobacteriaceae, *E.coli* represent 6.3% (10/158), *Klebsilla Spp.* 5.7% (9/158) and *proteus Spp.* 4.4% (7/158). Our results are similar to that previously reported in Brazil for *E. coli* (6.8%) and *Pseudomonas aeruginosa* (2.3%) isolated from the hands of food handlers (**Souza and Santos, 2009**) and South Africa which reported that *E. coli* was isolated from 7.8% of food handlers hands (**Lues, 2006**).

Our results were much lower than that reported by **Lues and Tonder (2007)** in South African as they found Enterobacteriaceae were present on hands of 44% of food handlers and *S. aureus* was 88%. Also **Mudey et al. (2010)** conducted a cross-sectional study on food handler in a rural area of Wardha district of Central India and reported that the frequency of pathogenic organisms in their hands were 56.87% for Staphylococci, 17.50% for *E.coli* and 21.87% for *Klebsilla Spp.* The different degrees of hand contamination between studies could be explained by the degree of adherence of food handlers to food safety measures and hand washing in different geographic regions. **Shojaei et al. (2006)** reported that the hands of 72.7% of Iranian food handlers were found to be contaminated with pathogenic flora of faeces or nose before simple hand-washing with significant decline to 32% after hand-washing.

Chronic asymptomatic *Salmonella* carrier food handlers may be a potential source of *Salmonella* spp. transmission also *Shigella* spp can be transmitted from food handlers by contaminated hands. So this study has also attempted to isolate *Salmonella* and *Shigella* spp. From stools of food handler participate in this study also urine samples were collected to diagnose *Salmonella* carrier. Our results revealed that all stool and urine samples were negative for *Salmonella* and *Shigella* spp. these finding were in agreement with **Andargie et al. (2008)** who reported that no *Salmonella* species were isolated from food handlers. Although *Salmonella* carrier rate among food handlers range between 0.1% to 3% in many studies conducted in different geographic regions (**Yousefi-Mashouf et al., 2003, Feglo et al., 2004, Asghar et al., 2006, Ahmed and Hassa, 2010**), it should be continuously surveyed because of high infectivity of this organism.

It is obvious that hand contamination indicates the non compliance of most food handlers to hand washing regulation. Also the carrier rates of different organisms may indicate the importance of pre-employment laboratory investigations and the continuous monitoring of food handlers. Pre employment training is important and continuous

observation of workers by an assigned senior staff is very important to ensure high degree of food safety.

### References

1. Acco M., Ferreira F.S., Henriques J.A.P. and Tondo E.C. (2003). Identification of multiple strains of *Staphylococcus aureus* colonizing the nasal mucosa of food handlers. *J Food Microbiol*, 20(5):489–493.
2. Ahmed H and Hassan H. (2010). Bacteriological and parasitological assessment of food handlers in the Omdurman area of Sudan. *J Microbiol Immunol*, 43(1):70–73.
3. Andargie G, Kassu A, Moges F, Tiruneh M and Henry K.(2008) Prevalence of Bacteria and Intestinal Parasites among Food-handlers in Gondar town, North West Ethiopia. *J. Health Popul. Nutr.*; 26(4):451-455.
4. Asghar A, Zafar T and Momenah A. (2006). Bacteriological and serological survey of infectious disease among food handlers in Makkah. *Ann Saudi Med*, 26 (2):141-144.
5. Aycicek H, Aydoğan H, Kiiciikkaraaslan A, Baysallar M and Baoustaoflu AC. (2004). Assessment of the bacterial contamination on hands of hospital food handlers. *Food Control.*; 15: 253-9
6. Barza, M. (2004). Efficacy and tolerability of ClO<sub>2</sub>-generating gloves. *Clinical Infectious Diseases*, 38, 857–863.
7. Clayton, D. A., GriYth, D. J., Price, P., & Peters, A. C. (2002). Food handlers' beliefs and self-reported practices. *International Journal of Environmental Health Research*, 12, 25–39.
8. Cogan, T. A., Slader, J., BloomWeld, S. F., & Humphrey, T. J. (2002). Achieving hygiene in the domestic kitchen: The effectiveness of commonly used cleaning procedures. *Journal of Applied Microbiology*, 92, 885–892.
9. Collins, J. E. (2001). Impact of changing consumer lifestyles on the emergence/re-emergence of foodborne pathogens. *Emerging Infectious Diseases*, 3(4), 1–13.
10. Department of Health, South Africa (2000). Guidelines for environmental health oYcers on the interpretation of microbiological analysis data of food. Directorate, Food Control. Pretoria: Government Printer.
11. Dharod JM, Paciello S, Bermúdez-Millán A, Venkitanarayanan K, Damio G, Pérez-Escamilla R. (2009). Bacterial contamination of hands increases risk of cross-contamination among low-income Puerto Rican meal preparers. *J Nutr Educ Behav.*; 41 (6): 389-397.
12. Feglo P. K., Frimpong E. H. and Essel-Ahun M. (2008) . Salmonella Carrier Status of Food Vendors in Kumasi, Ghana. *East African Medical Journal*. 81 (7) : 358-361.
13. Figueroa G, Navarrete P, Caro M, Troncoso M, Faúndez G.(2002). Carriage of enterotoxigenic *Staphylococcus aureus* in food handlers. *Rev Med Chil.*;130(8):859-64.
14. Green LR, Selman CA, Radke V, Ripley D, Mack JC, Reimann DW, Stigger T, Motsinger M, and Bushnell L.(2006). Food worker hand washing practices: an observation study. *J Food Prot.*; 69(10):2417-23.
15. Gunduz T, Limoncu ME, Cumen S, Ari A, Etiz S and Tay Z. (2008) Prevalence of intestinal parasites and nasal carriage of *Staphylococcus aureus* among food handlers in Manisa Turkey. *J Environ Health*, 18(5):230–235
16. Ingham, S. C., Reyes, J. C. N., Schoeller, N. P., & Lang, M. M. (2000). Potential use of presumptive enterococci and staphylococci as indicators of sanitary conditions in plants making hard Italian-type cheese. *Journal of Food Protection*, 63, 1697–1701.
17. Jiang, X. P., & Doyle, M. P. (1999). Fate of *Escherichia coli* 0157:H7 and *Salmonella enteritidis* on currency. *Journal of Food Protection*, 62, 805–807.
18. Jumaa PA.(2005). Hand hygiene: simple and complex. *International Journal of Infectious Diseases*. 2005; 9: 3-14.
19. Kibret M., and Abera B.(2012).The Sanitary Conditions of Food Service Establishments and Food Safety Knowledge and Practices of Food Handlers in Bahir Dar Town. *Ethiop J Health Sci.*; 22(1): 27–35.
20. Kusumaningrum, H. D., Riboldi, G., Hazeleger, W. C., & Beumer, R. R. (2003). Survival of foodborne pathogens on stainless steel surfaces and cross-contamination to foods. *International Journal of Food Microbiology*, 85, 227–236.
21. Loeto D., Matsheka M.L., Gashe B.A.(2007). Enterotoxigenic and antibiotic resistance determination of *Staphylococcus aureus* strains isolated from food handlers in Gaborone, Botswana. *J Food Protect*, 70(12):2764–2768
22. Lucet J-C.(2002). Rigaud M.-P, Mentrey F, Kassisz N, Deblangy C, Andreumontzx A and Bouvetx E. Hand contamination before and after different hand hygiene techniques: a randomized clinical trial. *Journal of Hospital Infection*; 50: 276 -280

23. Lues JF. (2006). Assessing food safety and associated food handling practices in street food vending. *International Journal of Environmental Health Research.*; 16(5): 319-28
24. Lues J.F.R. and Tonder I.V.( 2007). The occurrence of indicator bacteria on hands and aprons of food handlers in the delicatessen sections of a retail group. *Food Control.*; 18: 326-32.
25. Moore, G., & Griffith, C. (2002). A comparison of surface sampling methods for detecting coliforms on food contact surfaces. *Food Microbiology*, 19, 65–73.
26. Mudey A.B., Kesharwani N, Mudey G.A., Goyal R.C., Ajay K Dawale A.K., and Vasant V Wagh V.V. (2010). Health Status and Personal Hygiene among Food Handlers Working at Food Establishment around a Rural Teaching Hospital in Wardha District of Maharashtra, India. *Global Journal of Health Science*, 2 (2): 198-206.
27. Rippel, B. (2002). Consumer knowledge about food safety revealed. Washington, DC: Consumer Alert.
28. Scott, E., & Bloomfield, S. F. (1990). The survival and transfer of microbial-contamination via cloths, hands and utensils. *Journal of Applied Bacteriology*, 68, 271–278.
29. Setiabudhi, M., Theis, M., & Norback, J. (1997). Integrating hazard analysis and critical control point (HACCP) and sanitation for verifiable food safety. *Journal of the American Dietetic Association*, 97(8), 889–891.
30. Shojaei H., Shooshtaripoor J. and Amiri M. (2006). Efficacy of simple hand-washing in reduction of microbial hand contamination of Iranian food handlers. *Food Research International*, 39(5):525-529
31. Souza P.A. and Santos D.A. (2009). Microbiological ICROBIOLOGICAL Risk Factors Associated With Food Handlers in Elementary Schools from Brazil. *Journal of Food Safety*, 29(3): 424–429
32. Teferi MD, Wube MT, Yehuala FM, and Mehari ZT.( 2012) Survey of nasal carriage of *Staphylococcus aureus* and intestinal parasites among food handlers working at Gondar University, Northwest Ethiopia. *BMC Public Health*, 12 (1): 837.
33. Williams R.E.O. (1993). Healthy carriage of *Staphylococcus aureus*: its prevalence and importance. *J Bacteriol Rev* 1993, 27:56–71.
34. World Health Organization: Food safety and food borne illness. Geneva: WHO; 2007a.
35. World Health Organization: Food Safety – Food borne diseases and value chain management for food safety, “Forging links between Agriculture and Health” CGIAR on Agriculture and Health Meeting in WHO/HQ. 2007b.
36. Yousefi-Mashouf R., Rangbar M., Mossavi M.J. and Ahmady M. (2003). Prevalence of Salmonella Carriers among Food Handlers and Detection of Drug Resistance of Isolates in Hamadan. *Journal of Research in Health Sciences*, 3 (2): 25-28.

11/10/2012

## Factors in the expansion of NATO after the Cold War

Iraj Mazarei

PhD student in political science, University of Kerala, India

[Irajmazarei54@yahoo.com](mailto:Irajmazarei54@yahoo.com)

**Abstract:** End of the Cold War was considered as a transitional period for NATO. In this period, new tasks of NATO were based on the way of ensuring the peace and stability in Europe and cooperation with NATO non-member countries and according to this second way, the issue of establishing the NATO forces out of the boundaries of member countries was proposed for the first time. In this paper, we seek to examine the factors affecting the expansion of NATO after the Cold War. In summary, the results of study show that the following factors are effective in this regard: creating the racial and ethnic crises in the Balkans and inability of European countries in resolving this crisis, existence of new threats against the interests of West such as terrorism, Islamic fundamentalism, Weapons of mass destruction, etc ..., fear of Russia's revival and return of this country to the authoritarianism and regain the control of eastern Europe, lack of alternative for a capable and ensuring security structure instead of NATO.

[Iraj Mazarei. **Effect of NATO expansion into the Central Asia and the Caucasus and Russia's reaction to it.** *Life Sci J* 2012;9(4):2941-2949] (ISSN:1097-8135). <http://www.lifesciencesite.com>. 430

**Keywords:** NATO, expansion of NATO, Cold War

### 1 - Introduction:

Cold War is a term which refers to a period of tension, conflict and competition in the relations of the United States, the Soviet Union and their allies from 1940s to 1990s. During this period, the competition between these two superpowers was continued in diverse fields such as military alliance, ideology, psychology, espionage, sport, military equipment, and industry and technology development. These competitions led to the consequences such as spatial competitions, paying the high defense costs, nuclear war games and a number of indirect wars.

Despite the fact that no direct military confrontation was happened between the United States and the Soviet Union during the Cold War, the expansion of military power and major political tensions and conflicts between the countries allied with this superpower were among its consequences. Despite the allies of the United States and the Soviet Union during the Second World War and against Nazi Germany, they had disagreement about the reorganizing the world after the war even before the end of war.

After the war, while America was trying to limit the communism in the world, the Cold War was expanded into the several parts of world especially Western Europe, the Middle East and Southeast Asia. In this period, the recurrent crises such as construction of Berlin Wall [1961-1989], Korean War [1950-1953], Vietnam War [1959-1975], Cuban Missile Crisis (1962), and Soviet war in Afghanistan [1979 - 1988] were happened and the beginning of a World War was not unexpected every moment, but finally if did not

happen. One of the reasons that both sides avoided form a direct war was their access to nuclear weapons and fear of using these weapons by the opposite side.

Finally, the Cold War ended at the end of 1980s and by senior officials' meetings, which were arranged by the last Soviet leader, Mikhail Gorbachev, and according to Gorbachev's reforming program.

End of the Cold War was considered as a transitional period for NATO. In this period, new tasks of NATO were based on the way of ensuring the peace and stability in Europe and cooperation with NATO non-member countries and according to this second way, the issue of establishing the NATO forces out of the boundaries of member countries was proposed for the first time. In this paper, we seek to examine the factors affecting the expansion of NATO after the Cold War.

### 2 - Theoretical Principles of NATO Expansion

#### 2-1 - Theoretical points of view and issues

Traditional literature of alliances proposes that the coalition is built in response to the threat and when the threat is reduced, the alliance will be continued no longer. Researchers have paid less attention to what the alliances are faced with at the time of change and threat or lack of threat. Those, who have studied the alliance under these conditions, have generally concluded that the alliance will have no durability without the threat.

With inspiration of "Waltz's" view about North Atlantic Treaty Organization (NATO) at the end of the Cold War, the Neorealism Theory predicts that:

A) Following the elimination of threat, which justifies the high level of military costs, the members of NATO also reduce the military costs.

B) NATO members will be involved in the conflicts over the common policy. Moreover, they will adopt a more independent orientation in their own defense and foreign policies.

Furthermore, the international institutionalism view considers NATO beyond a mere military alliance. Based on these theorists' view, with hundreds offices and facilities, which NATO has in the member countries, it is a multilateral coalition which the West has applied it as a powerful political tool and a method for dealing with the security issues of Europe, linking with the European Union and governments member in Warsaw Pact .

Therefore, based on the institutionalists' view, NATO is not a dimensional treaty which can be collapse like other military unions in case of reduced threat. In general, it can be stated that those, who predicted the end of NATO, have provided a more than limited imagination about the function and date of NATO and mainly based on the military functions and geographical limitations. NATO has numerous mechanisms for development of severe military functions and has used these facilities in line with important civilian functions. As the institutionalists expect NATO has taken advantage of organizational resources for its own continuation and has change its tasks.

Geopolitical and environmental theories also study the correlation of geography and political power. Researchers of this branch of science emphasize that the geographic factors have a direct correlation with the national power and the geographic factors determination or limit the players' political behavior. They also believe that the large geographic space means to have hegemony and superior power in the region and throughout the World.

### **2-2 - Political-Security point of view**

Bipolar system of the Second World War leading by two superpowers (USA and Soviet Union) created two independent and hostile blocks. Conflict of two blocks was in fact the motivation for internal unity and coordination of members' policies and this system created a kind of integration of policies for each block and also the existence of common enemy and widespread publicity in this field prevented from intra-group differences (Haj Yousefi, 1995) and this led to the negative outcomes such as internal tensions, growth of nationalism, the socialism and racism, ethnicity, and reviving the longstanding border disputes, which were not happened until then due to

the rule of international system based on the Cold War.

This difference had vast domain and more than eighty-two conflicts happened around the world during the years from 1982 to 1988 or 6 years.

### **2-3 – Economic-Political point of view**

Based on this point of view, the mystery of capitalism survival lies on its expansion in all aspects. Unlike the communist system, which can survive in a limited land, the capitalist system cannot be survived through the stagnation. However, the barriers, which are classified into external and internal factors, threaten the development of capitalist system. Internal barriers are as the results of internal changes and the external barriers are due to the incompatibility of other phenomena with this phenomenon. Thus, the historical experience of external barriers in agricultural production systems of Soviet, the pioneer and Communist world leader, are considered as the external serious obstacles to the expansion of capitalism (Taeb, 1999).

Moreover, the internal barriers to the growth and development of fascism in three countries including Germany, Italy and Japan in thirtieth decade of twentieth century were considered as the barriers to the development of capitalism in the world. Fascism is considered as the political entity of monopoly capital.

### **2-4 - Economic globalization and changing the concept of security**

Economic globalization has had several important international effects:

First, it has eliminated the importance of boundaries and barriers; the government cannot establish the national sovereignty like the past concept.

Second, most of the multinational companies have seized the power from the governments in the global market of power and have become as the main players in the scene of international relations. Now, it can be stated that the governments are afraid of multinational companies.

Third, the international organizations have become important along with the important economic issues and multinational companies and weak and influenced governments. The international organizations' role, which was ignored in the realistic point of view, was gradually increased and more important and now we can see the increasing power of United Nations and dependent institutions, International Monetary Fund, World Bank etc.

Fourth, changing the concept of power and security is the results of economic globalization and in this type of world the economy speaks first and



military issues and weapon forces have lost their own influence to a large extent.

## 2-5 - New World System and Role of NATO

Nowadays, there are more than 190 countries around the world and the existence of these numbers of players is unprecedented, although a kind of ideological and economic compatibility can be seen throughout the history. Unity is the unit feature of this symmetrical unipolar system. It is the unity, which is in the controllable multiplicity; multiplicity in the approaches and unity in equality of criteria and objectives (Dehshiar, 2009).

America can continue the current domination role after the Cold War if it continues the existing "bargaining space" and intensifies it if possible. This only is possible if it does not allow the current compounds of power, which are based on inhibition described, capitalistic, fixed and competitive models and liberal thoughts, to be instable. This bargaining space creates an opportunity for the United States to weaken the potential opponents and impose its own power position in the field of power of other countries of system to them.

## 4 - NATO and expansion policy

Cooperation of Central Asia and the Caucasus countries with North Atlantic Treaty Organization within the framework of Participation for Peace Program has led to a positive reaction of NATO members and especially the United States. Countries, which demand the membership in NATO, should strengthen the strategic interests of this union and increase the security of West states. Now, this question is raised that what interests and objectives the NATO members including the United States have due to the comprehensive presence in Central Asia and the Caucasus? (Shirazi, 2000)

### 4-1 – Presence in the Russia's Backyard<sup>1</sup> and filling the created power gap after the Fragmentation of Soviet

After the Fragmentation of Soviet, Russia was replaced with it. Some of the analysts have considered Russia as the threatening factor, while others believe that the process of NATO expansion is

---

The term "backyard" refers to the set of Russia's neighbors which are located across the western and southern borders of this country. Countries like Estonia, Latvia, Lithuania in the Baltic Sea, and countries of Central Asia and the Caucasus are part of the Russia's backyard and security fence barrier.

not completely Anti-Russian, but one of its incentives is definitely Russian.<sup>2</sup> AS "Brzezinski" expresses his own concerns about Expansionist Russia in one of his books. He argues that the created power gap in Eurasia, as the result of Soviet Union Fragmentation, has the potential to disturb the balance of power.

He believes that while Russia is the most powerful country in Central Eurasia, the countries in Eurasia are face with two options; first, moving toward the European democracy and priority in creating a link with Europe, and second creating the European empire through reintegration of Russia's domination on dissatisfied and weak neighbors after the fragmentation of Soviet (Mandelbaum, 2006).

While the first option helps to create the regional stability, the second option leads to Russia's geopolitical isolation. As a result, defense of U.S.A interests means the inhibition of Russia combined with building the trust for the countries located in Eurasia and their movement towards the international organizations and western dominant security unions (Brzezinski, 1997).

Countries, which are located in Eurasia region and are kinds of small countries, will be remained independent countries in long term without joining the West security structures. Moreover, "Javier Solana", NATO former secretary general, declared in a statement in February 1997 that if the countries of the Caucasus remained out of the Europe zone, Europe would be completely secure. Thus the process of expanding NATO into the Caucasus and Central Asia is justified in order to preserve the independence of countries located in Eurasia against the Russia's domination.

### 4-2 – Dominating the oil resources and other natural resources in countries of Central Asia and the Caucasus

Exaggerated estimates have been provided about the amount of oil and gas and it seems that most of the declared statistics have political and commercial reasons. The last realistic estimates of known reserves have put the position of Caspian Sea oil and gas in the world's third largest oil field after Persian Gulf and Siberia.

Three important features of Caspian Sea oil field:

Possibility of easy utilization

Being close to consumption markets

Being located in Europe connecting road to Indian Ocean and the north of Caspian Sea to its south.

---

The North Atlantic Council, The Atlantic Strategic Concept In Washington D.C. On 23RD and 24Th. April 1999

These features have reduced the exclusive reliance of several major countries, which consume the energy, on the oil and gas of Persian Gulf, although the Persian Gulf field still has the largest resources of World energy (Dehghan, 1999).

Great and mainly undiscovered energy resources in Caspian Sea have provided new opportunities for the world oil market, region and the United States. According to the West and NATO view, Central Asia and the Caucasus will have a significant geopolitical growth during next 10 to 15 years and this is due to the potential portion which they will have as the result of providing the global energy and security (Croissant, 1998). Strategic evolution and development of NATO, the changed geopolitical environment in Caspian Sea region and the tendency of regional countries towards relying on NATO in order to be on balance with Russia raise this issue whether the West security interests have sufficient importance for justifying the commitment and military involvement of NATO in this region? In the case that it has necessary importance, the West will have increasing and significant investment in creating the security of region and the stability, sovereignty and independence of new states, which have been created as the result of Soviet Fragmentation in current decade, both based on the geopolitical reasons and in terms of energy security (Yousefi, 2000).

#### **4-3 – Preventing from the risk of dominance of regional powers**

Aside from the existence of abundant natural resources in Caspian Sea region, the geopolitical position and locating at intersection of East and West, the regional and trans-regional powers compete with each other for influencing this region. Therefore, as the member of NATO and leading by the United States, the West attempts to welcome more and closer links to the republics of Central Asia and the Caucasus in order to provide its own interests and preventing from the dominance of regional powers such as Russia, China, Iran, Pakistan and India in Caspian Sea region (Shirazi, 2000).

#### **4-4 - Combat terrorism and Proliferation of Weapons of Mass Destruction**

Preventing from the Proliferation of Weapons of Mass Destruction is one of the NATO members' interests in Central Asia and the Caucasus regions because this region has the significant amount of uranium hidden in unreliable regions. After the fragmentation of Soviet and following the events on 11<sup>th</sup> September, there is this concern that some of specific countries or terrorist groups may seize the

mentioned Uranium, infrastructure and its experts (Cohen, 2003).

After the events on 11<sup>th</sup> September, the issue of terrorism was put on the security agenda of the United States and NATO; in fact these events showed its essential role for the security of countries more than any other time and made the need for NATO maintenance essential for collective confronting with it by posing an objective and a serious threat against the West (Karami, 2003).

Neighborhood of Central Asia republics with Afghanistan and influence of the whole region of Central Asia and the Caucasus by the radical Islam procedure and weakness of governments in this region against the above procedure on the one hand, and considering this region among the regions with vital interests for the West and especially the United States, and providing the objective of NATO based on combating the terrorism on the other hand rationally justify the policy of expansion of NATO into the region. Furthermore, the policy of NATO in supporting the control of weapons, disarmament and non-proliferation, which plays the central role in Union achievement of security objectives, justifies the presence of NATO in Central Asia and the Caucasus regions and this is potentially a source of instability.

### **5 - Findings:**

#### **5-1 - Fields of expansion of NATO after the Cold War**

The existence philosophy of NATO was questioned after the end of Cold War and fragmentation of bipolar structure because the alliance theories never predicted that the alliances would be continued in the case that their main threats were disappeared. Nevertheless, the political and international issues analysts had been faced with a new reality by the issue of continuity and expansion of NATO and had tried to legitimize the continuity and retention of NATO. More criticisms were about the realistic and neo-realistic theories. Consequently, some of the analysts sought to justify the issue by utilizing the institutionalism theory and international regimes. Here, the fields and background which expanded NATO after the Cold War are studied.

#### **5-1-1 - Establishment and Consolidation of Democracy**

Some of the analysts argued that the expansion of NATO can ensure the democracy and stability in a united Europe. When the expansion of NATO into the East was raised for the first time, the governors in major countries of NATO and especially the Americans declared clearly that there were conditions for the membership in NATO. In other

words, they could not accept any country which demands the membership in NATO. They have clearly expressed that the countries, which have accepted the democracy and implemented its basis, can be the member of NATO. Based on the West scholars and governors' point of view, there is no fundamental difference between the democracy and liberalistic capitalism of and the main objective of NATO Expansion is to inhibit and destroy all potential and actual barriers to the development of liberalistic capitalism (Taeb, 1999).

### **5-1-2 – Providing and Strengthening the Security and Stability**

Strengthening the security is one of the main reasons of the expansion of NATO. The process of expansion will increase Europe security against the actual or potential or civilian threats.

The threats, which are inevitable for the expansion of NATO, include:

#### **5-1-2-1 - Russia**

Official policy of NATO and the real reason of the expansion of NATO is mainly the prevention of so-called risk of Moscow. This policy has always been the main issue of NATO and this Union has not been able to provide the convincing alternative for the reason of its own existence. Fear of reviving an independent and a strong government in the vast land of Russia has disturbed once more the West World. They are seeking to prevent the creation of this power in Moscow. Meanwhile, NATO is the main tool which can inhibit Russia. European countries and the United States know that Russia is not the Soviet Union any more, but it has the status and privileges which give it the vast power, and according to the power of military and nuclear weapons and influence on the Third World countries and its own former subsidiary countries, Moscow can endanger the security of Europe as a potential risk (Latifi, 1997-98).

On the other hand, the expansion of NATO into the central and Eastern Europe consolidates the position of these countries against Russia. Some of the countries in the central and Eastern Europe are willing to cooperate with the winner of the Cold War, thus they are demanding to join NATO.

#### **5-1-2-2 - Islamism**

During the years, when Gorbachev came to the power, the groups like Hizb ut-Tahrir, Akromiya group, Lashkar-e-Taiba, Hizb-an-Nusra, Tablighi Jamaat, Hezbollah and Islamic Movement of Uzbekistan were created and developed in the region due to the relative open political-social space in the

Soviet. Hizb ut-Tahrir is the most significant radical Islamist group which is active in the region.

Number of members in this party of Uzbekistan, where is the main center of its activities in Central Asia region, is estimated between seventeen to sixty thousand members. Therefore, based on NATO strategic planners' points of view, the Islamic force in the Eastern region is considered as the most serious risk for the expansion of this treaty, but it is the only excuse for the expansion of this military treaty. The Islamism movement of "Fundamentalism" is one of the issues which have been considered by the United States. In fact, by the fragmentation of the Soviet Union, the Islamism movement was the only common point which could attract the NATO members' agreement (Mousavi, 1999).

#### **5-1-2-3 - Extreme Nationalism**

Some of the analysts believe that the continuation of NATO after the Cold War of NATO, in which there is the United States, indicates the requirement of Europe to the presence of the United States in the Europe (although this covers the United States' Interests). Concern of political -military elites in Europe is based on this issue that the Western Europe states will return to the destructive nationalistic past and the security- armed competition begin due to the collapse of NATO. It is clear for the Europeans that since 1945, the serious military-competitive policies were reduced in Western Europe and this was due to the ensuring results of the United States' presence in Europe. Therefore, one of the reasons of NATO continuation is due to this Europeans' concern, under which the outcome of the United States' exit from Europe will change the economic-political relations of Western Europe states and at least will begin the severe security competition. In this case, the presence of NATO, which is doing changes for compatibility with the new international structure, will be so important. In fact, by continuity of NATO activity, which ensures the military presence of the United States in Europe, the Europeans can establish the economic and political relations inside the stable Western Europe (Garmaroudi, 1999).

#### **5-1-2-4 - Proliferation of Weapons of Mass Destruction and Terrorism**

A large amount nuclear weapons remained form the era of Soviet domination and the possibility of sending them secretly to other countries was another challenging which justified the continuity of NATO. Terrorism event on 11<sup>th</sup> September 2001 as a sudden and quick return to the reality of the world and its contradictions and as the optimistic ending of democratic values also changed NATO completely

and affected the functional field of this organization. Soon after the events on 11<sup>th</sup> September, NATO formed the largest permanent union in the world against the Terrorism by adopting important measures and new commitments for itself through the "Combined Joint Task Forces". NATO has taken serious attention to the increased participation of organization forces in operation against the World Terrorism, continuous and serious effort for preventing from the Proliferation of Weapons of Mass Destruction and tools for transporting them, and preparation against the terrorist attacks by using the chemical, biological, radiological and nuclear weapons in order to Adapt itself with new conditions and developments and strengthening the capabilities of organization with new threats. (Farsaei, 2002) In fact, it can be stated that based on the new method of play in the international field, not only the Terrorism now has become the most and highest risk and threat against the international peace and security, but it mutually has reduced the intensity of traditional and past threats unity, which was the sense of threat by powers towards each other. In fact, the terrorism has led to the change of criteria towards the international threat and risk as well as leading the governments into finding the common aspects which can be resulted in the coalitions and cooperation (Torabi, 2002).

#### **5-1-2-5 - China**

China is a strong country which has the potential to become as a more outstanding power during a few decades (Pickering, 2000). It is stated that China will become as one of the world poles in 21st Century. Thus, limiting the role of Asians and especially China in new system is one of the reasons for the expansion of NATO into the East and especially the influence area of the Union Soviet around the boundaries of China (Taeb, 1999).

#### **5-2 - Factors which facilitate the expansion of NATO**

Essentially, providing the new strategy of NATO was first discussed at the leaders' summit in London in July 1990 and after it in Rome in November 1991; changing the structure of forces quantitatively and qualitatively was among the agreement cases at this summit. In other words, it was weakened in terms of quantitative aspect but strengthened in terms of qualitative aspect. Existence of multinational forces, the existence of forces which could be immediately ready, strengthening the communications among the forces, greater mobility of forces, higher aggregation of forces in the central region of this organization and using the nuclear weapons as the last weapon were among the principles

of this new strategy (Sarraf-Yazdi, 2002). On this basis, the institutions were created in order to facilitate the process of the expansion of NATO slowly and developmentally. These institutions were as follows:

#### **5 -2 - 1 - Establishment of North Atlantic Cooperation Council (NACC)**

At the beginning and following the Rome Conference, the "North Atlantic Cooperation Council" had the task to establish a regular communication between the NATO organization members and former members of Warsaw Pact. For this purpose, this council was held meetings at two levels of foreign affairs ministers and ambassadors of Member Countries in NATO and former members of Warsaw Pact. The first annual conference at the level of foreign affairs ministers was held on 20<sup>th</sup> December 1991 and then the ambassadors' conference was held on 10<sup>th</sup> March 1992. During these meetings, different security issues including the development of cooperation were raised in the field of defense, exchanging the information and establishing the air lines and the participants came to the agreement. Similarly, at next meetings, the member countries in North Atlantic Cooperation Council emphasized on other issues especially the necessity to strengthen the democracy bases and supervising the members' military forces (Rahmani, 1998).

#### **5-2-2 - "Partnership for Peace" program**

This program was first raised by the United States at common summit for the defense and foreign ministers of NATO member countries in Germany in October 1993 and was approved at the Leaders' Summit in Brussels in January 1994 (Rahmani, 1998).

In general, 25 states (All which except three ones were either the member of Warsaw Pact or among the republics of the Soviet) accepted this invitation. Participation For Peace Program is not multilateral treaty, but is a set of mutual contracts which has been concluded between NATO and any state interested in the membership and has been implemented within the framework of an individual participation program. Therefore, a member government in Participation for Peace program like Russia is not considered as the partner of other government like Poland, but is the partner of NATO Treaty.

The objective of this program is to encourage the non-member countries in NATO in order to develop the military and defense cooperation with NATO.

In fact on the one hand, the Participation For Peace program engage the NATO member governments to help other governments, which join

this project, with planning, Education and military exercises and even if their national security, territorial integrity and political independence are endangered, they have a right to consult with NATO, and on the other hand, the governments, which involve the participation program are assigned to accept commitments (Azami, 2002).

### **5-2-3 - Euro- Atlantic Partnership Council (EAPC)**

Institution of Euro- Atlantic Partnership Council (EAPC) was replaced with North Atlantic Cooperation Council (NACC) in May 1997. The task of this alternative institution is to provide a framework for establishing the link among the foreign ministers of member governments in NATO, the states involved in the Partnership for Peace program and other European and Asian State (Betty, 2001).

### **5-2-4 - Combined Joint Task Forces (CJTFS)**

Creation of these forces was approved by NATO members in January 1994, but its final approval was in June 1996. Philosophy of creating these forces was to integrate the multinational separate forces with versatile military service under a joint combined command within the overall framework of NATO. Mentioned forces are supervised by the Western Europe Union and can do the tasks within the framework of Article (5) of NATO association or out of this framework by using the facilities and infrastructures of NATO. Furthermore, these forces can utilize the participation of non-member states in NATO or even the participation of the Euro-Atlantic region in order to do their own tasks. Participation in these forces is voluntary and is done based on the system of special voluntary coalitions or is done case to case and in voluntary way. These forces have the function of NATO support which increases the flexibility of NATO as well as providing the fields for increasing the role of its European allies by the West European Union (Azami, 2002).

### **5-2-5 - Membership Action Plan (MAP)**

Membership Action Plan was provided in April 1999. Based on this plan, the states, which demand the membership in NATO, provided a list of activities which have been done in line with preparing themselves in mentioned union. Therefore, the relevant plan is not focused on establishing the standards and criteria necessary for the membership of mentioned states in NATO and only specifies the issues which may be discussed. These issues are: Issues Political and economic issues, defense-military issues, issues related to the resources, security and legal issues. Therefore, this plan has been a kind of practical declaration in line with the policy of open

doors and the states, which demand to join the NATO, apply it.

### **5-2-6 - Rapid Reaction Forces (RRFS)**

NATO Union declared its own decision about creating the first Rapid Reaction Forces in October 2003. Based on the points of view of member states in NATO, creating these forces increase the flexibility of the union with the capacity of intervention in mild conflict, combating with terrorism and Proliferation of Weapons of Mass Destruction, lead of the peace preservation operation and support of human's friendly missions within and out of Europe and it can help to evolve it.

### **6 - Conclusion:**

The reasons for the expansion of NATO can be summarized as follows:

The creation of racial and ethnic crises in the Balkans and disability of European countries in resolving these crises;

Existence of new threats to the West interests like terrorism, Islamic fundamentalism, Weapons of Mass Destruction, etc...;

Fear of Russia's revival and this country's return to the authoritarianism and re-dominance on Eastern Europe;

And the lack of replacement for the security and capable structure instead of NATO. The United States is willing to the continuity of NATO based on two reasons; first, Washington has considered NATO as the military arm for its own policies and hegemony objectives and even some of the analysts have considered NATO as the toolbox of the U.S foreign policy. Second, the collapse of NATO can seriously undermine the role and position of America in Europe. By NATO, the United States will be able to impose its own leadership on Europe and apply Europe as the platform for dominating the strategic region of Asia, Middle East and other sensitive areas. European countries also demand the NATO continuity and its presence in Europe. There are several points of view in this regard;

A - Countries freed from the hegemony of the Soviet which demanded the membership in NATO and its continuity and also the presence of the United States in Europe due to the fear of Russia's re-dominance.

B - Small and medium-sized countries in Europe such as the Netherlands, Belgium and Luxembourg, Greece and..., which were worried about the hegemony of France and Germany, believed that the persistence of NATO is beneficial to the future of Europe.

After the Cold War, allies in both sides of Atlantic voted to the continuity of NATO and merely called for the structural reform of in this organization.

Structural reforms in NATO were done in various issues at the same time with changing the existence philosophy of NATO. NATO defined its own enemy in another way and fighting against the terrorism and fundamentalism and preventing the Proliferation of weapons of mass destruction were replaced with the Soviet threat. In this new strategic environment after the Cold War, the global main risk (The Soviet threat) has been replaced with low-intensity, numerous and multilateral risks. Therefore, the changes in the nature of threats has also changed the NATO's operation, thus the new role of NATO is to help to promote democracy and the process of democratization, peacekeeping, bringing the peace, and management of international crises and these have made the new missions of NATO.

North Atlantic region was the area which was already considered for NATO because the factor of (The Soviet) threat was in this region, but with new proposed definition of safety, the range of the West security contains all international system and it will change NATO to the world police. On the other hand, due to the expansion of NATO into new and in-conflict regions, NATO requires the fewer number of military forces which are more experienced and high capable and compatible with new regions and crises.

By limiting the army and making it smaller, NATO is seeking to change its own members to a more dynamic and smaller army and change the strategic plans of organization from the regional defense to the armed interventional and rapid reaction forces. The plan for the expansion of NATO into the East after the Cold War was the most important and discussable measure of NATO in order to adapt the structure with the international developments. The primary objective of this plan was to prevent from any kinds of security gap in the region after abolishing Warsaw Pact and the lack of any types of security structure in Eastern and Central Europe and after the creation of fundamentalism ethnic-Sect threats.

But NATO seeks a variety of security, political, economic and cultural objectives in its plan of expansion into the East and this is done by different mechanisms. North Atlantic Cooperation Council and Partnership for Peace program are among the main mechanisms of NATO in the plan of expansion into the East.

Finally, it can be concluded that the newly independent republics in Central Asia and the Caucasus are seeking to the convergence with Euro-American structures. The security and stability are the main issues for these countries, thus they have been convinced that NATO can play an important role in creating the peace and stability in these countries. These republics, which are called as the small and

weak governments, are seeking to eliminate their own external and internal deficiencies and vulnerabilities within the framework of trans-regional cooperation. Fear of Russia's re-domination has caused that these countries to tend towards Western countries in order to maintain their internal stability and territorial integrity; as Azerbaijan has declared its willingness to grant the base to NATO and the United States in the Absheron Island.

On the other hand, the strategic geo-economic position of region has caused that NATO to have interests in the Caucasus and Central Asia and also to be interested in participating in this important area. But naturally, the process of NATO expansion into the Central Asia and the Caucasus has opponents including the Islamic Republic of Iran because the presence of NATO in the region will have negative effect on the national security of Iran. Structural developments at the level of Central Asia and the Caucasus regions can be resulted in serious threats for the national security of Iran. Therefore, by a deep understanding of current developments in the region it is necessary to manage the status quo by careful planning and using diplomatic methods and taking the initiative.

#### References:

1. Azami, Nabiollah, NATO, Collective Security System and its developments after the Cold War, Quarterly Journal of Foreign Policy, sixteenth Year, No. 3 (Fall 2002)
2. Betty, Rabin, Ambiguous signs of NATO in Central Asia and the Caucasus, Quarterly Journal of Central Asia and the Caucasus Studies, Ninth year, vol. 3, No. 33 (Spring 2001)
3. Pickering, Thomas; India, China and Russia in terms of the United States point of view, Translated by Majid Alavi-Kia, Quarterly Journal of Foreign Policy, fourteenth Year (Spring 2000)
4. Taeb, Saeid, Expansion of NATO into the East: Another View, Journal of Foreign Policy specific for Europe (2), Fall 1999
5. Torabi, Shahram, Terrorism and Evolution in the International System, Monthly Journal of views, analyses, institute for Political and International Studies, sixteenth Year (July 2002)
6. Hajj-Yousefi, Amir-Mohammad, Security of Europe and Future of NATO Political- Economic Information, Ninth year, Nos. 11 and 12, August and September 1995
7. Dehshiar, Hossein, Symmetric unipolar System; Concept of Power from the View of the United States, Foreign Policy Journal, Thirteenth Year, No. 3

8. Rahmani, Mansour, Development of Security Role of NATO and Security and Cooperation Organization of Europe, Quarterly Journal of Central Asia and the Caucasus Studies, No. 22 - (Summer 1998)
9. Seifzadeh, Seyyed-Hossein, Puzzle of new security and challenge of the West, (Tehran: institute for Political and International Studies, 2004)
10. Sarraf-Yazdi, Gholamreza, NATO: Past, Now and Future (Political-Economic Information, Nos. 177-178, June and July 2002)
11. Farsaei, Shahram; New Political and Security Developments of Europe Union (Tehran, institute for Political and International Studies, 2003)
12. Farsaei, Shahram; Changes in function and expansion of NATO function, Monthly Journal of Points of view and Analyses, institute for Political and International Studies, sixteenth Year (March 2002)
13. -Garmaroudi, A.R, Security of Europe and "NATO" after the Cold War, Sobhe Emrooz Newspaper (02/06/1999)
14. Latifi, Aref; NATO and Security of Europe, M.A Thesis, Islamic Azad University of Central Tehran branch (1997-98)
15. Mostakin, Abdolmahdi, Change in the Existence Philosophy of NATO, Hamshahri Diplomatic, No. 29, 08/23/2005
16. Mousavi, Seyyed Hossein; Expansion of NATO into the East and Middle East Quarterly Journal of Middle East Studies, Sixth Year, No. 1, (Spring 1999)
17. Dehshiar, Hossein, (2009), symmetric unipolar system, the concept of power from the perspective of the United States, Journal of foreign policy, Thirteenth Year, No. 3
18. Dehghan Tarzjani, Mahmoud, Priorities and Resources of Threats to the National Interests of Iran in the Central Asia and the Caucasus, Monthly Journal of Political-Economic Information, fourteenth Year, Nos. 1 and 2, (October and November 1999), p. 72.
19. Cohen, Frederick, NATO and the South Caucasus: More Effort for nothing? Translated by Saeid Naghizadeh, Quarterly Journal of Central Asia and the Caucasus Studies, Twelfth Year, Vol. 3, No. 42 - (Summer 2003)
20. Karami, Jahangir, Russia's Foreign Policy: Problem of defining the Interests and Contradictory Behavior, Quarterly Journal of Asia Central and the Caucasus Studies, Eleventh Year, Vol. 3 - No. 41 (Spring 2003)
21. Yousefi – Nooraddin, NATO and Security of Caspian Sea, Mission in the distance, Quarterly journal of Strategic Studies, Second Year, No.3, (Fall 2000)
22. Michael Mandelbaum(2006), Russian foreign policv In Historical Perspective, In Michae ondelbaum(ed),The New Russian foreign Policy(New York:The Council on foreign Relation inc
23. Zbigniew Brzezinski. The Grand Chessboard, New York: Hamper Callins, 1997).
24. Michael Croissant, The Armenia–Azerbaijan Conflict, (West Port: Prayer Publishers,1998),p.136
25. Abolhassan Shirazi, Habibollah, Security Arrangements in Central Asia and the Caucasus (Quarterly Journal of Central Asia and the Caucasus Studies, No. 30, summer, 2000.

11/10/2012

## The Use of Different Tense in Autistic Children

Ameneh Zare<sup>1</sup>, Shahin Nematzadeh<sup>2</sup>

<sup>1</sup>: Department of Linguistics, Science and Research Branch, Islamic Azad University, Ph.D Student, Tehran, Iran

<sup>2</sup>: Department of Cognitive Linguistics, Institute for Cognitive Studies

E-mail: [a86.zare@yahoo.com](mailto:a86.zare@yahoo.com); E-mail: [snematzadeh@iricss.org](mailto:snematzadeh@iricss.org).

**Abstract:** Autism spectrum disorder is characterized by abnormalities in social communication, language abilities and repetitive behaviors. The present study focused on some grammatical deficits in autistic children. We evaluated the impairment of correct use of different Persian verb tenses in autistic children's speech. Two standardized Language Test were administered then gathered data were analyzed. The main result of this study was significant difference between the mean scores of correct responses to present tense in comparison with past tense in Persian language. This study demonstrated that tense is severely impaired in autistic children's speech. Our findings indicated those autistic children's production of simple present/ past tense opposition to be better than production of future and past periphrastic forms (past perfect, present perfect, past progressive).

[Ameneh Zare, Shahin Nematzadeh. **The Use of Different Tense in Autistic Children.** *Life Sci J* 2012;9(4):2950-2954] (ISSN:1097-8135). <http://www.lifesciencesite.com>. 431

**Keywords:** Autism, Past, Persian Language, Present, Tense.

I

### INTRODUCTION

Autism is a complex developmental disability that typically appears during the first three years of life and affects a person's ability to communicate and interact with others.

Autistic children almost always begin to speak much later than normal. This seems to be a general consensus among other researchers, that autistic children simply develop language later, rather than developing in a different manner [1]. Some researchers [2] discovered that most likely children diagnosed with autism have no language growth until the age of three and are faced with difficulties. A great deal of research regarding the low IQ score of autistic children indicates the relationship of this low level to language abilities. However, Findings showed that a high IQ score is not necessarily a sign of high level of language and speech [3]. Almost half of autistic children are incapable of using language as a method of communication [4]. According to [5] a level of language abilities of these children are either dismissed or have stopped growing.

Speech in autistic children in comparison with normal children is distinctive in three aspects: 1-The autistic children have more growth in their production abilities than their language abilities. 2-they have more growth in words comprehension than grammatical comprehension. 3-more growth in verbal abilities in comparison with verbal comprehension [6].

Although autistic speech was described as being grammatically correct, it was often reported that use of syntax was primitive and limited in forms [7]. This is highlighted by evidence that at high mean length of utterance (MLUs) there is an over estimation of index of productive syntax (IPS) as autistic grammatical

constructs. Autism is a social disorder, meaning that a child with autism may be highly intelligent academically, but will always suffer difficulties in social environment [8]. Many autistic people have a surprisingly wide vocabulary, considering their low levels of comprehension and communication skills. The ability to name objects as an isolated skill doesn't indicate the development of communicative language. Indeed, the reverse may be the case [9]. Children with autism begin to develop normal speech, but then suddenly lose the acquired speech and fail to progress linguistically; this disappearance usually occurs between 18 and 30 months of age [10]. Some autistic children may be unable to speak, whereas others may have rich vocabularies and are able to talk about topics of interest in great depth. Despite this variation, the majority of autistic individuals have little or no problem with pronunciation. Most have difficulty effectively using language. Some researchers tested children with autism and they found that some autistic children have normal language skills whereas others performed significantly below chronological age expectations [11]. Omission of certain morphemes in obligatory contexts was more frequent among children with autism, particularly articles (a, the), auxiliary and copula verbs and children with autism were significantly less likely to mark past tense than were matched controls with Down Syndrome [12].

### II. METHOD

#### A. PARTICIPANTS

The study included 56 children with autism. The sample included 39 boys and 17 girls between the age of 6-12 years and were able to complete the experimental task described below. Children were diagnosed with autism using DSM-IV criteria. The



diagnosis was based on the autism diagnostic Interview-Revised [13] and the Autism Diagnostic Observation Schedule [14] and confirmed by an expert clinician.

#### B. INSTRUMENTS

Two standardized language tests were administered, including the PPVT, and the Repetition of Nonsense Words [15]. Rice's Standard Language Test administered to elicit past tense forms and PPVT administered for dividing participants into three groups on the basis of their performance on the Peabody Picture Vocabulary Test III. Using the criteria that were adopted for defining language subgroups in autism [16]. Group 1: Normal children with PPVT 85 or over. Group 2: Borderline children with PPVT between 70 and 84. Group 3: Impaired children with PPVT below 70.

#### C. PROCEDURE

Participants were given opportunities to produce 20 different past tense forms and 15 present tense forms on different lexical verbs such as cook, write,

come....There was an initial training example using the verb "cook". The experimenter gave the following instructions: "I have two pictures. I will describe the first one, and you tell me about the second picture." After placing the first picture in front of the child, the experimenter said: "Here is the girl cooking". Then the second picture was placed on the table, and the experimenter said: "Now she is done. Tell me what the girl did." If the child failed to produce the target verb, two prompts were given, including "Tell me what she did to eggs" or "what happened?" If children didn't produce the target *cooked*, the experimenter modeled the correct answer on the training trial. Similar experimental task was administered for present tense too.

#### D. SCORING

Children's responses were scored as correct or incorrect. Incorrect scores were then scored with respect to the types of errors made.

#### III. RESULTS

TABLE I. PARTICIPANT CHARACTERISTICS

Group	N	Age (Mean)	female	Male
Normal	18	9.27	5	13
Borderline	17	9.70	5	12
Impaired	21	9.23	7	14

TABLE II. PERCENTAGE OF CORRECT RESPONSES ON PAST TENSE

Group	Correct Response	Simple Past	Past Perfect	Present Perfect	Progressive Past
Normal	47.5%	74.44%	6.66%	62.22%	46.66%
Mean	9.5	3.722	0.333	3.111	2.500
SD	26.5	0.752	0.485	0.900	0.707
Range		5-3	1-0	5-2	4-1
Borderline	38.23%	61.17%	2.35%	52.94%	36.47%
Mean	7.64	3.059	0.1176	2.647	1.824
SD	22.1	0.556	0.3321	0.702	0.883
Range	88	4-2	1-0	4-1	4-1
Impaired	28.80%	49.52%	0%	44.76%	20.95%
Mean	5.76	2.476	0	2.238	1.048
SD	24	0.814	0	0.625	0.921
Range	88	4-1	3-0	3-1	3-0
Total	38.17%	41.71%	3%	53.30%	34.69%
Mean	7.63	3.23	.14	1.99	1.74

Table II presents the different scores of correct responses by the different language subgroups on the past tense task. Averaged across all the children more than half the responses were incorrect, and the most frequent error pattern was using periphrastic verb forms. Children's performance in Normal and Borderline groups was similar with respect to the proportion of correct responses. They performed similarly in the simple and other verb responses too, but the Impaired group (28.80%) exhibited fewer correct responses in comparison with other groups. Findings indicate that autistic children in Normal group were better on past tense forms whereas the Impaired group were worse than either of other subgroups on past perfect tense as well as present Perfect & progressive tense forms.

The proportion of responses that were echolalic or classified as "no responses" by children in Impaired group was more than level of children in either Normal group or Borderline group.

TABLE III. PERCENTAGE OF CORRECT RESPONSES ON PRESENT AND FUTURE TENS

Group	Correct Response	Simple Present	Progressive Present	Future Form	No Response
Normal	73.33%	94.44%	86.66%	38.88%	0.47%
Mean	11	4.722	4.333	2.056	
SD	27	0.461	0.594	0.725	
Range		5-4	5-3	3-2	
Borderline	57.25%	82.35%	74.11%	15.29%	2.01
Mean	8.58	4.118	3.706	0.765	
SD	31	0.600	0.588	0.752	
Range		5-3	5-3	2-0	
Impaired	50.47%	80%	60.95%	7.61%	2.72%
Mean	7.57	4.143	3.00	0.381	
SD	40.6	0.727	0.775	0.669	
Range		5-3	4-1	2-0	
Total	60.35%	85.59%	73.90%	20.59%	1.73%
Mean	8.98	4.32	3.66	1	2.15

The most frequent error pattern was using future tense. Children's performance in impaired and Borderline groups was similar with respect to the proportion of correct responses. They performed similarly in the simple present and other present tense responses, but the Normal group exhibited more correct responses in comparison with other groups.

Table III shows that autistic children in Normal group were better on present tense forms but the Impaired group were worse than either of other subgroups on future tense as

Well as progressive present forms. The proportion of responses that were echolalic, or classified as "no responses" by children in Impaired group was more than level of children in either Normal group or Borderline group.

Results show that there is a meaningful differences between N&B in past tense correct responses (normal  $M=2.42, SD=18$ /Borderline  $M=1.91, SD=17$ ) with  $P<0.05$ ,  $P=0.037$  as well as in present tense correct responses (normal  $M=3.70, SD=1.33$ / Borderline  $M=2.86, SD=1.64$ ) with  $P<0.05$ ,  $P=0.005$  but there is not a meaningful difference between B&I in present tense correct responses (Borderline  $M=2.86, SD=1.64$ / impaired  $M=2.51, SD=1.74$ ) with  $P>0.05, P=0.266$  while there is meaningful difference in their past tense correct responses (Borderline  $M=1.91, SD=1.33$ / impaired  $M=1.44, SD=1.21$ ) with  $P=0.02$ . Statistical between-group comparisons confirmed that Impaired group performed significantly worse than Normal & Borderline subjects on different Persian tense forms.

As illustrated in figure 1, The N group performed virtually perfectly on both simple present (85.59 %) and progressive present (73.90 %) with the mean score of (79.74 %) correct responses but they obtained higher error scores for past tense forms.

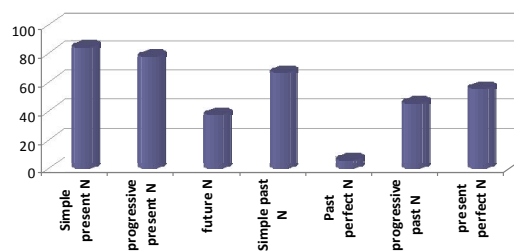


Fig. 1 The use of different tense in normal autistic children

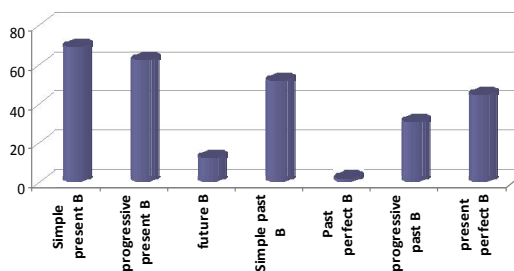


Fig. 2 The use of different tense in borderline autistic children

The B group did not exhibit any major problem with presents tense, whereas their performance of future tense was worse than that of N group and the B subjects managed to produce the past perfect tense in only 2.35% of all cases.

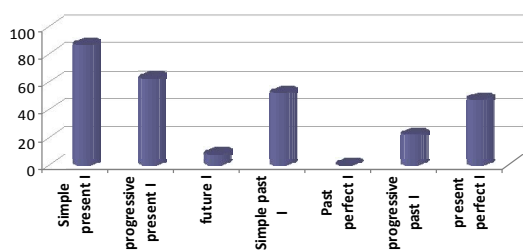


Fig. 3 The use of different tense in impaired autistic children

We obtained higher error scores for I group for different tense forms' correct responses than other groups.

IV. DISCUSSION AND CONCLUSION

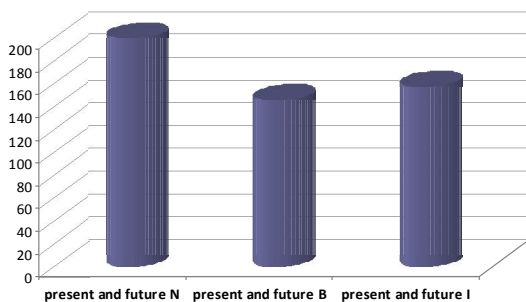


Fig. 4 Comparison of present & future tense production in all autistic children

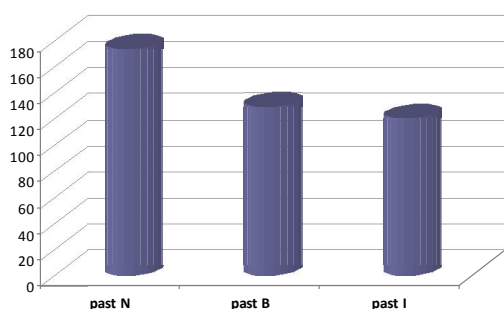


Fig. 5 Comparison of past tenses production in all autistic children

The goal of this study was to examine whether language impaired children with autism show difficulties in producing different tense forms. Our main findings were that all groups of children with autism showed high rates of error scores on past tense task. We also found some unique performance errors that reflected core autism deficit.

Autistic children failed to produce the required tense forms in 44% of all cases resorting to present forms instead. This suggests that present, past and future tense production was impaired in all autistic children groups.

In Persian, the simple past tense is not very common at least in the spoken language. Probably that's why past tense production in their speech is more impaired than present tense. In Persian in discourse context, future tense doesn't follow its grammatical rules (simple present verb stem" want" (xah) +verbal endings+ past tense verb stem of content verb) and Persian speakers tend to use present tense for future time reference and present tense encodes both present and future tense forms, which make it hard to interpret these error scores. Findings indicate that autistic's responses hierarchy for past tense can be described as follow:

**Simple past tense < Progressive < Present perfect < Past perfect.**

These results have strong correlation with the frequency of tense form's usage in that language. Simple past tense is less impaired and past perfect is the most impaired one. These results show that tense forms with complex structures or those who need auxiliaries are more impaired than others in all autistic children groups. As simple past tense structure in Persian is simpler, without any auxiliary (verb stem+ verbal endings), autistic children's past tense comprehension and production was considerable in comparison with other past tense forms. Since present tense is very common in spoken language, autistic children had fewer difficulties in present tense production and comprehension. Furthermore, present tense structures are used for future tense in Persian language. This can be explained for its common usage. Another reason that past tense is impaired in comparison with other tense forms is that past tense spectrum is too wide in Persian to distinguish between different past tense by all autistic children groups.

Results from language ability task with Persian autistic children demonstrate that tense were severely impaired particularly in their production. These findings suggest that there is a meaningful difference between past tense and other tense forms (present and future). Our results show that autistic children obtained higher error scores for past tense verbs than for present tense forms. The conclusion that can be drawn from this study is that they exhibited major problems with past perfect tense and their performance on past perfect was considerably worse than that of simple past tense with respect to its complex structure.

**REFERENCES**

- [1] K. Tuchman & I. Rapin, "The influence of premorbid language skills and behavior on language recovery in children with verbal auditory agnosia," *Child Neurology*, vol.15, no.4, pp.36-43, 2000.
- [2] P. Howlin, S. Goode, J. Hutton, & M. Rutter, "Adult outcome for children with autism," *Child Psychology and Psychiatry*, vol.45, pp.212-229, 2004.
- [3] B. M. Prizant, & J. F. Duchan, J.F., "The functions of immediate echolalia in autistic children," *Speech and Hearing Disorders*, vol.46, pp.241-249, 1996.
- [4] U. Frith, "Emphasis and meaning in recall in normal and autistic children," *Language and Speech*, vol.2, pp.29-38, 2003.
- [5] C. Jarrold, J. Boucher, & J. Russel, "Language profiles in children: methodological implications," *Autism* vol.1, pp. 57-76, 1997.
- [6] W. Fay & A. L. Schuler. *Emerging Language in Autistic Children*. Baltimore: University Park Press, 1980.
- [7] L. Wing, & J. Gould, "Severe impairments of social interaction and associated abnormalities in children: epidemiologic and classification," *Autism and Developmental Disorders*, vol.9, pp.11-29, 1979.
- [8] U. Frith, "A new look at language and communication in autism," *Disorders of Communication*, vol.24, pp.123-150, 1989.
- [9] L. Schreibman, *Autism*. Thousand Oaks, CA, US: Saga Press, 1988.
- [10] M. Kjelgaard, & H. Tager-Flusberg, "An investigation of language profiles in autism: Implications for genetic subgroups," *Language and Cognitive Processes*, vol.16, pp.287-308, 2001.
- [11] G. Bartolucci, & S. J. Pierce, "Cross-sectional studies of grammatical morphemes in autistic and mentally retarded children," *Autism and Developmental Disorders*, vol.10, pp.39-49, 1974.
- [12] H. Tager-Flusberg, "A psychological approach to understanding the social and language impairments in autism," *International Review of Psychiatry*, vol.11, pp.325-334, 1999.
- [13] C. Lord, M. Rutter, & A. LeCouteur, "Autism Diagnostic Interview-Revised: A revised version of diagnostic interview for caregivers of individuals with possible pervasive developmental disorders," *Autism and Developmental Disorders*, vol.24, pp.659-668, 1994.
- [14] C. Lord, S. Risi, L. Lambrecht, E. H. Cook, B. L. Leventhal, P. C. Dilavore, "The autism diagnostic observation schedule-generic: A standard measure of social and communication deficits associated with the spectrum of autism," *Autism and Developmental Disorders*, vol.30, pp.205-223, 2000.
- [15] M. Korkman, U. Kirk, & S. Kemp. *NEPSY: A developmental neuropsychological assessment*. San Antonio, TX: Psychological Corporation, Harcourt Brace, 1998.
- [16] M. L. Rice, K. Wexler, J. Marquis, & S. Hershberger, "Acquisition of past tense by children with specific language impairment," *Speech Language & Hearing Research*, vol. 43, pp. 1126-1145.

11/12/2012

## Fuzzy Logic Improved Static Synchronous Compensator to Control Voltage of a Grid-connected Squirrel Cage Induction Generator

Reza Sharifian Dastjerdi<sup>1</sup>, Ehsan Jafari<sup>2</sup>, Farshad Kabiri<sup>3</sup>, Payam Ghaebi Panah<sup>4</sup>

<sup>1,2,3,4</sup> Department of Electrical Engineering, Lenjan Branch, Islamic Azad University, Isfahan, Iran  
[sharifian@iauln.ac.ir](mailto:sharifian@iauln.ac.ir)

**Abstract:** In this paper a new model for a wind generation system is introduced which includes induction machine, static synchronous compensator, excitation and load capacitors. Moreover, a new method is proposed for voltage control of a grid-connected squirrel cage induction generator. Unfortunately, induction generators require a flexible reactive power source beside them since under variable load conditions the output voltage cannot remain constant autonomously. In this paper, a compensator is used to control the reactive power and stabilize voltage fluctuations during a three-phase fault and generator isolation. Furthermore, a fuzzy controller is developed to ameliorate compensator's performance. Accordingly, simulations are carried out in MATLAB/Simulink environment to confirm the abilities of new control scheme.

[Reza Sharifian Dastjerdi, Ehsan Jafari, Farshad Kabiri, Payam Ghaebi Panah. **Fuzzy Logic Improved Static Synchronous Compensator to Control Voltage of a Grid-connected Squirrel Cage Induction Generator.** *Life Sci J* 2012;9(4):2955-2960]. (ISSN: 1097-8135). <http://www.lifesciencesite.com>. 432

**Keywords:** Fuzzy Logic, Squirrel Cage Induction Generator, Static Synchronous Compensator, Three-phase Fault.

### 1. Introduction

Renewable energy has been developed greatly during recent years especially when the price of oil and subsequently relevant productions increased. Obviously, among different sources, wind power grabbed a huge attention. Hence, induction generators got a dominant role in the wind power generation. Apparently, salient features of induction generators are small size, separate dc excitation and brush omission, and low maintenance cost [1-2]. On the other hand, analyses of generator's voltage and frequency are easier when the machine is connected to the grid in comparison with the isolated situation [3-4]. The two main drawbacks of induction generators are weak voltage regulation and reactive power requirement. The needed reactive power is provided without any parallel capacitor and just from the DC link capacitor when it is charged. Generally, both generator and load are reactive power consumers. However, unbalanced reactive power causes voltage fluctuation. Therefore, a good choice for capacitance would be when the minimum required reactive power is proportional to inverse of squared speed and maximum amount is equal to the magnetizing reactance [5]. Logically, constant capacitors could not provide the appropriate reactive power. Therefore, a combined set of capacitors is installed which includes constant and switching types.

Fuzzy sets can be very helpful in making decision during different situations and thereupon the performance of compensator is improved. Off-grid generators sometimes suffer from excess or lack of active and reactive produced powers which can cause

frequency deregulation. An effective solution is to change the blades angle [7]. Blades angle is similar to steam turbine's valves through which the speed is controlled. Note that vividly the response time in wind turbines is very faster than steam types [8]. On the other hand, in a squirrel cage induction generator, the magnetizing reactive power in terminals is undesirable. Hence, capacitors are installed to obviate the problem. They can provide the magnetizing current and even load reactive power as well. Besides, a power electronic based compensator such as SVC, STATCOM, etc. is installed in parallel with the machine to make the response better during a fault. Numerous publications are dedicated to this issue. Some researchers focused on modeling of an induction machine and a capacitor next to [9]. This technique is useful in sliding mode control, state feedback, output feedback, etc. [1, 2, and 10].

### 2. Distribution System Model

A single line diagram is illustrated in Fig. 1 which represents the wind energy conversion system. This local system is fed by a generator which is connected to a 132kv infinite bus [1]. A 133/33kv transformer is a medium between local grid and infinite bus and similarly, a 33/0.6kv transformer connects the induction generator to the local grid.

Induction generator is driven by a wind turbine which is controlled via rotation angle ( $\beta$ ). In order to control  $\beta$ , a reference value is compared with the generator's injected power ( $p^*$ ). Afterwards, the resulted error is passed through a proportional-integral controller and therefore, an acceptable value for  $\beta$  is estimated. The capacitor provides the

required reactive power for the magnetizing current. The system's specifications are given in the appendix.

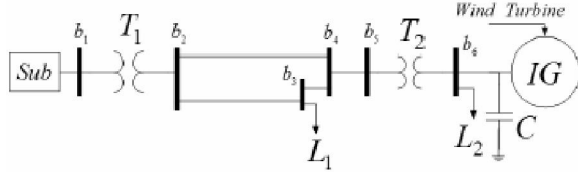


Figure 1. System model

**3. System Elements**

**3.1. Wind Turbine**

The output power of the induction generator is obtained as follows [1, 2, 3]:

$$P_m = \frac{1}{2} \rho \pi R^2 c_p(\lambda, B) V_w^2 \tag{1}$$

where  $\rho$  is air density,  $V_w$  is wind speed,  $R$  is blade length, and  $C_p$  indicates the fraction of aerodynamic wind power extracted from the turbine. Note that  $C_p$  varies with wind speed and can be defined as Equation (2).

$$C_p = 0.00051\lambda^5 - 0.001539\lambda^3 - 0.03892\lambda^2 - 0.0462\lambda - 0.000006 \tag{2}$$

$\lambda$  is the Blade tip speed and can be calculated using Equation (3).

$$\lambda = \frac{\omega_m R}{V_w} \tag{3}$$

where  $\omega_m$  is angular rotating velocity of turbine.

**3.2. Induction Generator**

Equation (4) presents model of induction generators in an optional reference frame [2-3]. In this equation, the rotor's residual flux is essential for generator to make the initial voltage. The upper case indices are related to rotor and conversely, the lower case ones are corresponding to stator values.

$$\begin{bmatrix} i_{qx} \\ i_{dx} \\ \lambda_{qr} \\ \lambda_{dr} \end{bmatrix} = \begin{bmatrix} r_s + \delta L_s \rho & \delta L_s \omega & \frac{L_{rs}}{L_r} \rho & \frac{L_{rs}}{L_r} \omega \\ -\delta L_s \omega & r_s + \delta L_s \rho & -\frac{L_{rs}}{L_r} \omega & \frac{L_{rs}}{L_r} \rho \\ -r_r \frac{L_{rs}}{L_r} & 0 & \frac{r_r}{L_r} + \rho & \omega_s - \omega_r \\ 0 & -r_r \frac{L_{rs}}{L_r} & -\omega_r & \frac{r_r}{L_r} + \rho \end{bmatrix} \begin{bmatrix} v_{qs} \\ v_{ds} \\ 0 \\ 0 \end{bmatrix} \tag{4}$$

where  $R_r$  and  $R_s$  are equivalent rotor and stator resistances respectively  $L_{Ls}$  and  $L_{Lr}$  are stator and rotor leakage inductances respectively,  $L_m$  magnetizing is inductance,  $L_s$  and  $L_r$  are stator and rotor inductances respectively.

(The (3),  $\delta$  and  $\rho$  values as relations (5) are defined).

$$\omega_r = \frac{P}{2} \omega_m, \rho = \frac{d}{dt}, \delta = 1 - \frac{L_m}{L_s L_r} \tag{5}$$

where  $w$  is an optional speed and  $\omega_r$  is the rotor speed in rad/s.

Figure (2) depicts the model of an asynchronous machine in which  $R_d$  is the resistance that indicates the absorbed power from the input. ( $R_d = (1 - s)R_r / s$ ).

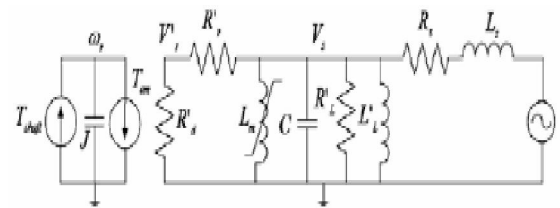


Figure 2. Induction generator model and the mechanical parts

$C$  is the field capacitor which provides the magnetizing current flow through  $L_m$ .  $R_1$  and  $L_1$  are loads. In generation mode, the rotor moves faster than the synchronous speed; therefore, slip value is negative ( $s < 0$ ). The capacitance can be calculated using produced reactive power and voltage.

**3.3. STATCOM**

Figure (3) shows a device which can compensate and control the voltage or power factor in the d-q coordinate [3-4].  $V_{abc}$  are generator terminal voltage,  $I_{abc}$  are three-phase currents injected by the compensator to grid,  $V_{rms}$  is the effective voltage, and  $V_{dc}$  is the dc voltage of capacitor. The controller consists of a phase locked loop in order to synchronize the three-phase voltage in the output of converter according to zero crossing point. Thus PLL creates  $\theta$  which is used in d-q conversion. (4)

Figure (3), This figure includes four PI controllers. The first block tunes terminal voltage with respect to the reference current  $i_q$ . Next PI has the role of keeping dc voltage constant via active power exchange with grid. In other words, the reference current  $i_d$  is determined by the second controller. The next two blocks produce base

voltages  $v_q$  and  $v_d$  which after conversion into three-phase system, the base voltage  $V_{abc}$  is formed and applied to inverter switches according to PWM scheme.

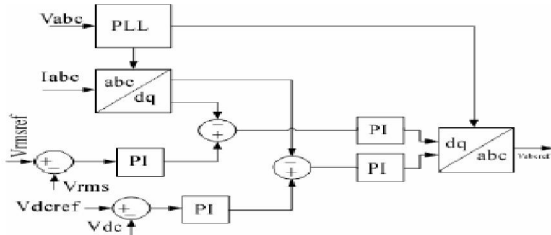


Figure 3. compensator control diagram

The STATCOM which should control power factor operates like the block responsible for voltage control but the only difference is that reactive power is tuned with regard to demand. Therefore,  $V_{rms-ref}$  should be replaced with  $Q_{ref}$  in Figure (3). This value is usually assumed zero to regulate the measured reactive power in the consumer's place.

**4. Fuzzy Control**

Den and en are fuzzy block inputs and zetan is the output signal.  $K_{de}$ ,  $K_e$ , and  $K_{zn}$  are values which can vary and have an important role in fuzzy controller performance in both transient and steady states.

In this research, the latter values are assumed constant and equal to 0.2, 500, and 0.05 respectively for simplification and easier implementation. As it is shown in Figure (4), triangular membership functions with overlap are used in both input and output of fuzzy block.

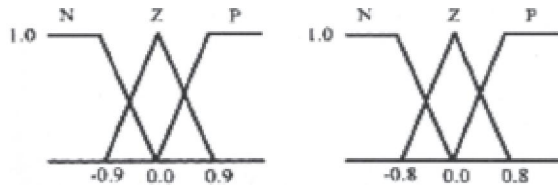


Fig. 4. compensator control diagram

Fuzzy rules are defined using linguistic variables listed in Table (1) which include N (Negative), Z (Zero), and P (Positive). Mamdani max-min technique is adopted to produce outputs from the fuzzy variables. Figure (5) depicts complete fuzzy system through which the reference voltage is obtained [6].

**5. System Modeling**

In this section, a new analytical model is presented for the system's behavior [2-3]. For simplicity, let's assume:

- 1) iron loss is negligible
- 2) All parameters are constant except the magnetic inductance.
- 3) All parts have three-phase star connected configuration.

Table 1: Fuzzy linguistic variables

den	en	zeta n
N	N	P
Z	N	P
P	N	Z
N	Z	P
Z	Z	Z
P	Z	N
N	P	Z
Z	P	N
P	P	N

In order to elevate modeling, the mechanical parts are taken into account and modeled in Figure (2). In this model, the applied torque to the shaft ( $\tau_{shaft}$ ) is modeled by a current source. Similarly, the electromechanical torque ( $\tau_{em}$ ) is shown as a current source. Finally, the inertia of rotor is modeled as a capacitor.

It should be noted that the mechanical model ( $\omega_r$  and  $\tau_{em}$ ) are DC variables whereas electric parts ( $V_r$  and  $V_s$ ) includes ac variables in 50 or 60 Hz.  $R_d$  is a negative resistance in generation mode which produces mechanical power ( $P_{em}$ ) and represents the converted power from mechanical to electrical form.

$R_s$  and  $L_s$  are equivalent resistance and inductance of transmission lines. In order to control the voltage, a current controlled voltage source is used in the model as shown in Figure (6 - a). In this model, another scheme (6 - b) is employed to tune the voltage source.

In this method, bus voltage is compared with a reference value and the subsequent error passes through a PI block to produce the required current for reactive power generation. This current affects voltage according to equation (6).

$$KV_s - V_s = L_d I_d \tag{6}$$

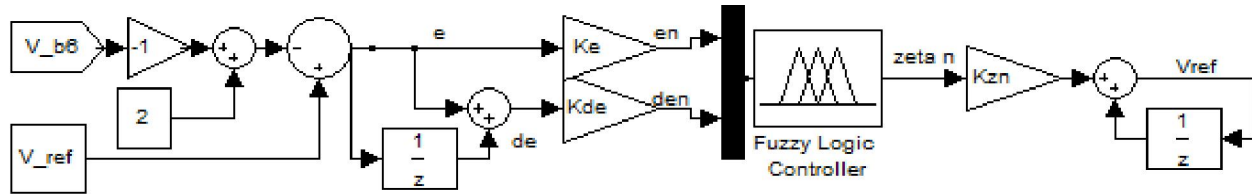


Figure 5. Fuzzy system diagram

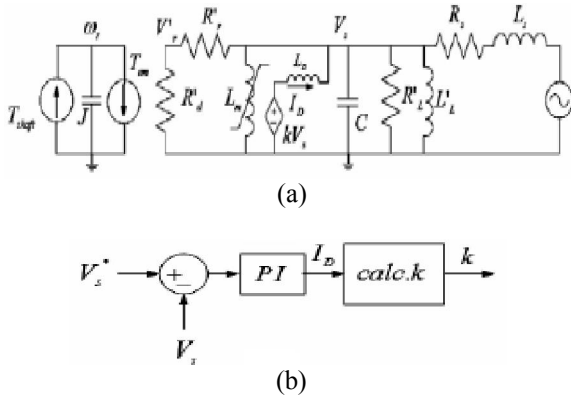


Figure 6. a) expanded model for voltage control  
b) control diagram

**6. Simulations**

Energy conversion system consists of a 9 MW wind turbine connected to a 33 kV distribution system. This source feeds a 133 kV load through a 25 Km transmission line. Stator of the squirrel cage induction generator is directly connected to a 60 Hz grid and the rotor moves by a turbine with a variable angle pitch.

Angle pitch is useful for the output power restriction when the speed is higher than normal (9 m/s). The output power can be extracted just when the speed is higher than the synchronous value. The speed usually changes from 1 pu in no-load and 1.005 pu in full-load conditions. Moreover, the generator has error monitoring equipments for current, voltage, and speed from which if a fault report received, the generator goes off. Besides, a group of capacitors, installed in the low voltage terminal bus, supply the required reactive power of generator, equal to 400kVar. The required reactive power for voltage stabilization is provided by a 3MVar compensator in the one per unit voltage (33kV).

The turbine delivers rated power (3 MW) at the rated speed (9 m/s). If wind speed changes, the output power alters with regard to the speed-power curve.

Here, wind speed at t=2s is set to 8 m/s and increases to 11 m/s in one second.

At t=15s a temporary fault occurs in the bus  $b_6$ . Subsequently, both active and reactive powers of

bus  $b_6$  are given in Figures (7) and (8). The corresponding dc voltage is illustrated in Figure (9). When simulation starts active power ascends gradually until nominal point in 5 seconds. During this period, the generator speed increases from 1.0028 to 1.0047pu. The resulted voltage without fuzzy controller in  $b_6$  is sketched in Figure (10).

The terminal voltage drops to around 0.97 due to wind speed change. If a fault is occurred, voltage variations are severe and perhaps the steady-state error would be remarkable. Figure (11) illustrates the bus voltage when fuzzy controller is running. Not only voltage variations in transient condition (due to wind speed alteration and errors) are improved but also in steady state mode the reference voltage is traced well. Furthermore, the generator's absorbed reactive power increases with the produced active power growth.

The generator demands reactive power of 1.47 MVar in the nominal state. The output power is 9 MVar in 11 m/s wind while the compensator keeps terminal voltage constant, equal to 0.984, via reactive power injection of 1.62 MVar. At t=15 a phase to phase fault occurs at  $b_6$  and it is obviated at t=15.11. The power injected by compensator is depicted in Figure (12).

The bus connected to generator is encountered with reactive power shortage; therefore, voltage drop is inevitable. At first, turbine's angle pitch is zero; however, when the output power exceeds 3 MW, the angle pitch expands to eight degrees for the output power compensation equal to the nominal value as it is shown in Figure (13). The parameters values employed in the simulation process are listed in Table 2.

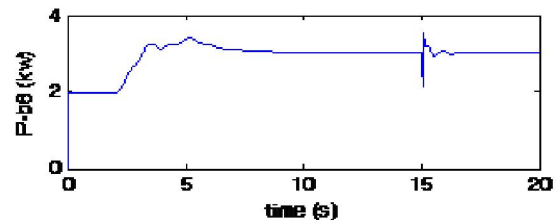


Figure 7. Active power of  $b_6$  bus



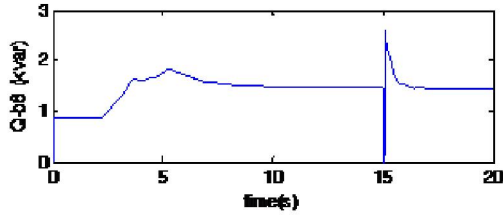


Figure 8. Ractive power of  $b_b$  bus

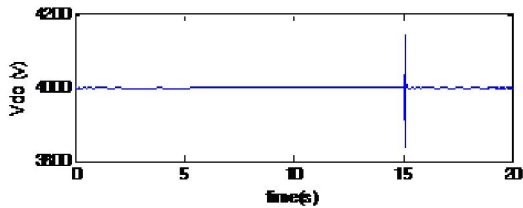


Figure 9. variation of DC link voltage

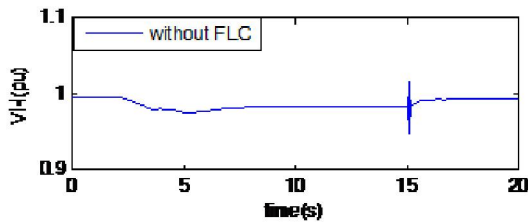


Figure 10. Line to line voltage without FLC

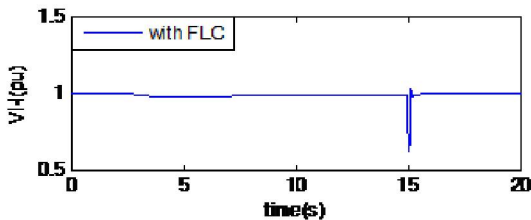


Figure 11. Line to line voltage with FLC

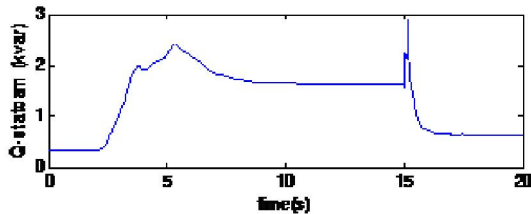


Figure 12. Reactive power injecting by STATCOM

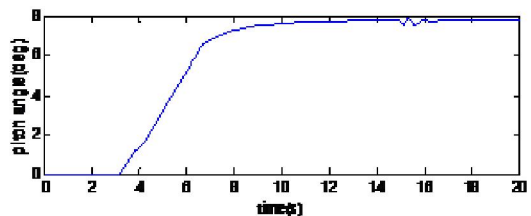


Figure 13. Pitch angle

**Conclusions**

In this paper a new model and a control diagram for a wind energy conversion system composed of load, exciting capacitor, and induction generator are introduced. The equivalent circuit makes a complete connection between electrical and mechanical parts. As a result, a deep insight into the behavior of both systems is achieved. Such these illustrated knowledge could be extremely worthwhile for controller design and voltage regulation.

The model aims to control the bus voltage via a compensator in an induction generator connected to the grid. To excel the compensation policy, a fuzzy controller is designed to determine the reference voltage. Considering simulation results, fuzzy controller ameliorates both transient and steady states voltage waveforms.

**Corresponding Author:**

Reza Sharifian  
 Department of Electrical Engineering,  
 Lenjan Branch, Islamic Azad University,  
 Isfahan, Iran.  
 E-mail: [sharifian@iauln.ac.ir](mailto:sharifian@iauln.ac.ir)

**Appendix**

Table 2. Parameter of simulation

parameter	value
$L_m$	650mH
$L_{lr}$	30mH
$L_{ls}$	30mH
$R_s$	5.67 $\Omega$
$R_r$	3.64 $\Omega$
P	2
F	60Hz
$P_N$	440Kw
$V_N$	460V
RPM	1450rpm

**References**

1. Moren J, Haan S, Kling W, Ferreira JA, Wind turbine emulating inertia and supporting primary frequency control, IEEE Trans. on Power Systems, vol. 21, No. 1, 2009.
2. Chen W, Hsu Y, Controller design for an induction generator driven by a variable speed wind turbine, IEEE Trans. on Energy Conversion, vol. 21, No. 3, pp. 625-635, September 2006.
3. Freitas W, Morelato A, Xu W, Sato F, Impacts of ac generators and D-Statcom devices on the dynamic performance of distribution systems, IEEE Trans. on Power Delivery, vol. 20, No. 2, pp. 1493-1500, April 2008.
4. Kumarasen N, Subiah M, Analysis and control of wind driven self-excited induction generators with load matching, in Proc. 11<sup>th</sup> National Power System Conf., Bangalore, India, Dec. 20–22, 2000, pp.21–26.
5. Tiwari HP, Diwedi JK, Minimum capacitance requirement for self-excited induction generator, in Proc. 12<sup>th</sup> Nat. Power System Conf., Kharagpur, India, 2002, pp. 5–10.
6. Driankov D, Hellendoorn H, Reinfrank M, An Introduction to Fuzzy Control. Springer-Verlag, 1993.
7. Chanand TF, Loi LL, induction generators self-excited with a single capacitance and supplying a single-phase load, IEEE Trans. Energy Convers., vol.17, pp.90–94, Mar.20 2002.
8. Bhatti TS, Bansal RC, Kothari DP, Reactive power control of isolated hybrid power systems , in Proc. Int. Conf. Computer Application Electrical Engineering Recent Advances, Roorkee, India, Feb.21–23, 2002, pp.626–632.
9. Wekhande S, Agarwal V, A new variable speed constant voltage controller for self-excited induction generator ,Electr Power Syst. Res., vol.59, no.3, pp.157–164, 2001.
10. Charles Smith J, Winds of change: issues in utility wind integration, IEEE Power and energy magazine, November/December 2005.

11/12/2012

## Comparison of viewpoints of staff members and students toward equipment and facilities of university

Dr Mohsen Ghofrani

Department of physical Education and Sport Sciences, Sistan and Baluchestan University, Zahedan, Iran

**Abstract:** The main purpose of this research was to compare the viewpoint of university students and staff members toward equipment and facilities of university. So 88 university students and 45 university staff members were selected randomly from Sistan and Baluchestan University. Data were analyzed by ANOVA test. The results showed that there was a significant difference between university students and staff members towards equipment and facilities of university. The authorities of university should pay more attention towards these courses to apply more sport saloons, fields and equipment for all university students. The results demonstrated there is no direct correlation between age and lesson content testing and facilities. The age of people is not determinate in relation to the facilities testing and lesson content but their age is effective in relations to teaching method and professor testing approach.

[Mohsen Ghofrani. **Comparison of viewpoints of staff members and students toward equipment and facilities of university.** *Life Sci J* 2012;9(4):2961-2962]. (ISSN: 1097-8135). <http://www.lifesciencesite.com>. 433

**Key words:** staff members, university students, equipment, facilities

### 1. Introduction

Physical training programs begin at primary schools and reach to its evolution process after passing guidance and high- school courses. At colleges, adolescents learn to find abilities to grow their talents and aptitudes by spending their different lesson plans and the role of physical training is significantly essential in this field, because the body and spiritual healthy issues can influence on their morality, emotional and mentality affairs; So, the quality and achievement of physical training lessons play key role in college settings efficiently. Since at college education period there are just devoted to students, they have to pass it as one physical training unit, thus it is necessary to increase the quality of these lessons; because this leads to upgrade students physical conditions and healthy issues and then they can get familiar with a one new sport field causing to accustomed to it as their daily routines. Thus, the recognition of physical training at colleges and being aware of educational systems and sport facilities as well as scoring. Testing methods are effective factors in supplementing physical training courses efficiently at college atmospheres; In addition, hiring responsible officials can bring positive remarks in this regard; however, the lack of any planning and precise programs based on sufficient data or the lack of determining any shortages or deficiencies can lead to worsen consequences' there fore, to reach to this purpose, the researcher gathers all related data by a questionnaire asking graduated people to fill the form out and also professors to fill the form out and also professors to give their comments in different dimensions and views in the field of physical training significance and teaching, testing and sport facilities; then the researcher analysis and evaluates them

through statistical methods as description approach to recover and boost all necessary requirements of the country's universities in this regard. According to the lack of these kinds of studies in the country, it is vital to assess many different studies in terms of lessons quality and quantity as well; because the positive consequences of these lessons can lead students to complete their physical activities efficiently and they can pay attention to their own mental and physical healthy issues after graduations; this, of course, gives them positive attribute towards exercise in the life. Coker (1972) in a study on the expertise fitness and the last background of teachers concluded that many teachers had better teaching strategies for teaching physical training course. They were all B.A. and 67% of them had M.A. or post – graduate students. The mean teaching background was also 7.2 year – dd. AAPHERD test was used to test these teachers. This research has been carried out by Bie (2007) in the field of physical training trainers status and sport facilities and equipments? He, then, concluded that these sport facilities and tools are in moderate position and most teachers do not have organized and coherent planning's to run these educational programs and this can make a negative result on educational strategies. Loughrey (1974) carried out a study on the study of teachers educational data sources and school teachers, teachers educational status, planning and literation; then the researcher prepared a fruitful handy pocket or manual for teachers and students to use it as their references.

### 3. Results

The level of significance ANOVA is equal to 0.005. With respect to significant level of test which is smaller than 0.05, the hypothesis will be rejected. As a result, there is significance difference

between satisfaction of student, member of faculty and staff. The results LSD post hoc test revealed that rate of satisfaction of students is less than members of faculty and staff significantly.

**Table 1.** ANOVA result for exploring relationship rate of satisfaction

group	Number	Mean	SD	F	Sig
Students	88	3.1218	.86003	5.588	.005
Faculty staff	46	3.4847	.94167		
Clerk	25	3.6917	.63179		

#### 4. Discussions

Most obtained results in the country represent that sport facilities cannot meet physical and movemental needs and due to the lack of sport spaces and sport educational locations made college or governmental officials not to pay attention enough to these considerations. Many students pretend that there is no enough time regarded to their sport/Physical training courses, college professors themselves agree with the lack of enough time devoted to physical education classes. Most people agree with the positive results of physical training courses on college students because it really increases the growth and happiness of students temperament as well. According to the obtained results, officials have recognized the purposed of physical education as moderated – based classes for college- bound students. Also, all these students complain about the status of testing method of their professors at sport educational classes and they want to run a comprehensive and detailed criteria for their scores through professors? Moreover, the content of the sport classes is really in low level and it would not persuade students to be encouraged in sport fields. All students know their high-level professors in sport considering their physical training programs more effective in this field. According to the foreign research results, sport facilities and skillful human resources made sport programs more significant; the high level education of sport professors and the lack of any problems in terms of sport feasibilities are the obvious signs if this proof (those colleges spend about 5 hours per week an sport classes). The positive effects of physical training lesson and help to learn other lessons and the effect of this lesson in total grades made students to be absorbed in this lesson. Due to the existence of educated professors at college atmosphere and other practical and theoretical lessons along with sport activities, and even to existence of written exam for students, we can conclude that schools and foreign colleges do not have any problems in the filed of professors, sport

facilities, budget and sanitary appliances and the degree of physical training classes as well as professors positive functions are satisfactory in students perspective during an educational term. In order to study the related purposes, the present data available in Tables of questionnaires was applied; for this reason, the related purposes were stated one by one and we will stop describing other information here.

#### References

1. Adams, J.A. (1971). Acbsed loop theory of motor learning. *Journal of motor behavior*.
2. Adams, T.M., Brynteson, P. (1992). A comparison of attitudes of exercise habits of alummi from colleges with varying degree of physical habits activaiting programs. *Research Quarterly for Exercise and Sport*. 63(2). 148-152.
3. Azjan, T, Fishbein, M. (1980). Understanding attitudes and predicting social behavior. Englewood cliffs, Prentice Hall.
4. Brodking, P., Weiss, M. (1990). Developmental differences in motivation for participation in competitive swimming. *Journal of sport & Exercise Psychology*. 12, 248-262.
5. Ebbeck, V., Gibbons, S.L., Likendalil, L.J. (1995). Reasons for adult participation physical activity. *Jpurnal of Sport Psychology*. 26(2). 262-275.
6. GoKarp, G., Kim, D.W., Skinner, P.C. (1985). Professor and student perceptions and beliefs about physical education. *Journal of Physical Education*. 43(3). 115-120.
7. MacDougal, D. et al. (2009). *Physiological Testing of the high performance athletic*. Human Kinetic Books.
8. Matnes, S.A., Battista, R. (2008). College mens' and womens' motives for participation in physical activity. *Perceptual Motor Skill*. 61(3): 719-726.
9. Martindale, E., Devlin, S., Vyse, S.A. (1990). Participation in college sports. 71(3). 113-115.
10. Okeindain, E.B. (2005). Training position of gymnastic programs in college Pensilvania University in Americans. NY: Mcbay.
11. Simons, J., Smon, F.L. (1974). *The history of the Olympic*. Marshal Cavamdish. London. New York, Sydney.
12. Zaichowsky, L.B. (2003). Additional differences in two types of physical education programs. *Research Quarterly*. 46(3): 364-370.

9/6/2012

## The viewpoint of university students and Staff members towards education

Dr Mohsen Ghofrani

Department of physical Education and Sport Sciences, Sistan and Baluchestan University, Zahedan, Iran

**Abstract:** The main purpose of this research was to study the viewpoint of university students and staff members towards Physical Education courses. So 88 university students and 45 university staff members of were selected randomly from Sistan and Baluchestan University. Data were analyzed by ANOVA test. The results showed that there was a significant difference between university students and staff members towards physical education courses. The authorities of university should pay more attention towards these courses to apply more sport saloons, fields and equipment for all university students. The results demonstrated there is no direct correlation between age and lesson content testing and facilities. There is a direct correlation between age and professors testing evaluation and teaching method.

[Mohsen Ghofrani. **The viewpoint of university students and Staff members towards education.** *Life Sci J* 2012;9(4):2963-2965]. (ISSN: 1097-8135). <http://www.lifesciencesite.com>. 434

**Key Words:** Education, facilities, age, staff member

### 1. Introduction

Physical education and training has been considered as a part of young generation education process of this land and if the process wants to progress, the potential teaching and learning methods should be nurtured sufficiently in this regard. The correct planning of physical training field from primary to high- school can make positive impacts on educational growth and increase the mental and physical abilities as well as prevent any diseases leading to lifelong of young people and decrease the high expenditures of diseases treatment. The physical training programs begin at primary schools and reach to its evolution process after passing guidance and high- school courses. At colleges, adolescents learn to find abilities to grow their talents and aptitudes by spending their different lesson plans and the role of physical training is significantly essential in this field, because the body and spiritual healthy issues can influence on their morality, emotional and mentality affairs; So, the quality and achievement of physical training lessons play key role in college settings efficiently. Since at college education period there are just devoted to students, they have to pass it as one physical training unit, thus it is necessary to increase the quality of these lessons; because this leads to upgrade students physical conditions and healthy issues and then they can get familiar with a one new sport field causing to accustomed to it as their daily routines. Thus the recognition of physical training at colleges and being aware of educational systems and sport facilities as well as scoring. Testing methods are effective factors in supplementing physical training courses efficiently at college atmospheres; In addition, hiring responsible officials can bring positive remarks in this regard; however, the lack of any planning and precise

programs based on sufficient data or the lack of determining any shortages or deficiencies can lead to worsen consequences' there fore, to reach to this purpose, the researcher gathers all related data by a questionnaire asking graduated people to fill the form out and also professors to fill the form out and also professors to give their comments in different dimensions and views in the field of physical training significance and teaching, testing and sport facilities; then the researcher analysis and evaluates them through statistical methods as description approach to recover and boost all necessary requirements of the country's universities in this regard. According to the lack of these kinds of studies in the country, it is vital to assess many different studies in terms of lessons quality and quantity as well; because the positive consequences of these lessons can lead students to complete their physical activities efficiently and they can pay attention to their own mental and physical healthy issues after graduations; this, of course, gives them positive attribute towards exercise in the life. Coker (1972) in a study on the expertise fitness and the last background of teachers concluded that many teachers had better teaching strategies for teaching physical training course. Oksen (1972) stated that 95% of colleges conduct these physical training courses as potentially as they do; 74% students stated that physical training is one of the most necessary courses they pretend to participate; many students believe that physical training programs are more flexible leading them to take part in these programs as well. This research has been carried out by Bie (2007) in the field of physical training trainers status and sport facilities and equipments? He, then, concluded that these sport facilities and tools are in moderate position and most teachers do not have organized and coherent planning's to run these

educational programs and this can make a negative result on educational strategies. Loughrey (2009) carried out a study on the study of teachers' educational data sources and school teachers, teachers' educational status, planning and literacy; then the researcher prepared a fruitful or manual for teachers and students to use it as their references.

## 2. Results

As the result of table 1 shows, there is significance difference between satisfaction of student, member of faculty and staff. The results LSD post hoc test revealed that rate of satisfaction of students is less than members of faculty and staff significantly.

**Table 1.** ANOVA result for exploring relationship rate satisfaction and group

group	Number	Mean	SD	F	Sig
Students	88	3.1218	.86003	5.588	.005
Members of faculty	46	3.4847	.94167		
Clerk	25	3.6917	.63179		

**Table 2.** T-test for survey rate satisfaction of member of faculty and staff

Variable	Number	Mean	SD	T	df	Difference SD
Rate of satisfaction	25	3.6917	.63179	5.474	24	.69167

As the result of table 2, there is no significant difference between rate of satisfaction of member of faculty and staff and status housing.

**Table 3.** ANOVA result for exploring relationship between rate of satisfaction of member of faculty and staff and their education

Status of education	Number	Mean	SD	F	Sig
High school	9	3.6736	.73228	1.514	.242
Diploma	10	3.4938	.47892		
Bachelor	6	4.0486	.64289		

As the result of table 3 shows, there is no significant rate satisfaction of member of faculty and staff and their education.

**Table 4.** ANOVA result for exploring relationship between rate of satisfaction of member of faculty and staff and their organizational

Status of education	Number	Mean	SD	F	Sig
Worker	10	3.7042	.69713	.927	.411
Clerk	11	3.5492	.49259		
Expert	4	4.0521	.82364		

As the result of table 4 shows, there is no significant rate satisfaction of member of faculty and staff and their organizational position.

**Table 5.** ANOVA result for exploring relationship between rate of satisfaction of member of faculty and staff and their number of children

number of children	Number	Mean	SD	F	Sig
2-1 child	9	3.8102	.63091	1.506	.246
4-3 child	8	3.6719	.65850		
5 child	6	3.2847	.33506		

As the result of table 5 shows, there is no significant rate satisfaction of member of faculty and staff and their number of children.

## 3. Discussions

Most obtained results in the country represent that sport facilities cannot meet physical and movemental needs and due to the lack of sport spaces and sport educational locations made college or governmental officials not to pay attention enough to these considerations. Many students pretend that there is no enough time regarded to their sport/Physical training courses, college professors themselves agree with the lack of enough time devoted to physical education classes. Most people agree with the positive results of physical training courses on college students because it really increases the growth and happiness of students temperament as well. According to the obtained results, officials have recognized the purposed of physical education as moderated – based classes for college- bound students. Also, all these students complain about the status of testing method of their professors at sport educational classes and they want to run a comprehensive and detailed criteria for their scores through professors? Moreover, the content of the sport classes is really in low level and it would not persuade students to be encouraged in sport fields. All students know their high-level professors in sport considering their physical training programs more effective in this field. According to the foreign research results, sport facilities and skillful human resources made sport programs more significant; the high level education of sport professors and the lack of any problems in terms of sport feasibilities are the obvious signs if this proof (those colleges spend about 5 hours per week an sport classes). The positive effects of physical training lesson and help to learn other lessons and the effect of this lesson in total grades made students to be absorbed in this lesson. Due to the existence of educated professors at college atmosphere and other practical and theoretical lessons along with sport activities, and even to existence of written exam for students, we can conclude that schools and foreign colleges do not have any problems in the filed of professors, sport facilities, budget and sanitary appliances and the degree of physical training classes as well as professors positive functions are satisfactory in

students perspective during an educational term. In order to study the related purposes, the present data available in Tables of questionnaires was applied; for this reason, the related purposes were stated one by one and we will stop describing other information here

### 5. Final term testing

In this regard, the mean students satisfaction were 61.32 with standard deviation 20.10 and minimum zero evaluation and maximum 100 obtained.

Most students had the highest evaluation degree of their physical- training professors scores.

The comparison of teaching method, lesson content, facilities and testing methodology of physical training professors by student- based comments:

Teaching method and professors testing approaches as well as lesson- based contents were in good positions; while the status of facilities was in a worse position. So, it can be concluded that most students have complete satisfaction in their all physical – training lessons, while the status of sport facilities was in low level in students' point of view. The determination of scores distributions in professors teaching method, lesson content and sport facilities in terms of students perspective:

All one- by- one elements have natural distributions in this study; this can be stated that all parametrical tests can be used to analysis data because of their natural situation.

The comparison of student- based evaluation from teaching method, content, facilities and professor testing elements and their different educational majors:

Based on carried out evaluation, the following results were obtained:

- 1- The evaluation of professor teaching method based on educational filed of students is different which the highest degree of satisfaction is related to technical and medical students.
- 2- The evaluation of physical – training lesson content based on student fields is not different; that is, this relation of educational fields based on their tastings has the same impact.
- 3- The evaluation of sport facilities based on student educational field is not different; that is, all have evaluated this facility in a low level of the evaluation.

- 4- The evaluation of students from professors testing based on education filed is not different; that is, their evaluations are about the same type.

The test of mean testing difference of elements (teaching method, lesson content, facilities and professor testing) based on membership in college team:

### References

1. Adams, J.A. (1971). Acbsed loop theory of motor learning. *Journal of motor behavior*.
2. Adams, T.M., Brynteson, P. (1992). A comparison of attitudes of exercise habits of alummi from colleges with varying degree of physical habits activaiting programs. *Research Quarterly for Exercise and Sport*. 63(2). 148-152.
3. Azjan, T, Fishbein, M. (1980). Understanding attitudes and predicting social behavior. Englewood cliffs, Prentice Hall.
4. Brodking, P., Weiss, M. (1990). Developmental differences in motivation for participation in competitive swimming. *Journal of sport & Exercise Psychology*. 12, 248-262.
5. Ebbeck, V., Gibbons, S.L., Likendalil, L.J. (1995). Reasons for adult participation physical activity. *Jpurnal of Sport Psychology*. 26(2). 262-275.
6. GoKarp, G., Kim, D.W., Skinner, P.C. (1985). Professor and student perceptions and beliefs about physical education. *Journal of Physical Education*. 43(3). 115-120.
7. MacDougal, D. et al. (1998). *Physiological Testing of the high performance athletic*. Human Kinetic Books.
8. Matnes, S.A., Battista, R. (1985). College mens' and womens' motives for participation in physical activity. *Perceptual Motor Skill*. 61(3): 719-726.
9. Martindale, E., Devlin, S., Vyse, S.A. (1990). Participation in college sports. 71(3). 113-115.
10. Okeindain, E.B. (1972). Training position of gymnastic programs in college Pensilvania University in Americans. NY: Mcbay.
11. Simons, J., Smon, F.L. (1974). *The history of the Olympic*. Marshal Cavamdish. London. New York, Sydney.

9/6/2012

## Structural analysis of the relationship between optometric practices and knowledge sharing intention

Kun-Shiang Chen

Department of Optometry, Chung Hwa University of Medical Technology, Tainan, Taiwan, ROC

Corresponding authors: [yco168@gmail.com](mailto:yco168@gmail.com)

**Abstract:** This paper aims to reveal the multidimensionality of knowledge-sharing intentions and its perception by employees in optometry practices. Data were collected from 187 optometry employees in Taiwan through a survey. The collected data were used to examine the proposed model. Empirical results show that individual autonomy, organizational collaboration, professional requirement, knowledge-sharing attitude, and perceived behavioral control exhibit direct and indirect positive relationships with knowledge-sharing intention. These factors are vital for supervisors in the optometric industry to maintain inter-organizational competitive advantage. Strengthening the professional knowledge of optometry employees solves the dilemma of knowledge-sharing intention in optometric practices. Furthermore, this study analyzed the intrinsic beliefs of optometry employees to provide insights for top management in formulating management strategies.

[Kun-Shiang Chen. **Structural analysis of the relationship between optometric practices and knowledge sharing intention.** *Life Sci J* 2012;9(4):2966-2968] (ISSN:1097-8135) <http://www.lifesciencesite.com>. 435

**Keywords:** individual autonomy, knowledge sharing intention, optometry practices, organizational collaboration, perceived behavioral control, professional require

### 1. Introduction

Over the past decades, knowledge management has been considered a critical factor in improving the competitive capability of organizations and achieving excellent business performance across barriers. The purpose of knowledge management is to sustain recognition and ensure the success and vitality of the entire organization. Prior literatures have documented that effective facilitation of employee knowledge sharing can lead to improvements in the management of organizational knowledge [1]. Exploring people's perceptions are important to organizations because of the diversity of individual views. Optometric practice lacks systematic empirical findings regarding the preconception of personal beliefs and its relationship with employees' knowledge-sharing intentions in the optometric industry. This study examines the differences in perception of work-related values in the optometric industry of Taiwan.

### 2. Literature review and hypothesis

As [4] posits, understanding the individual extrinsic and intrinsic impact of factors associated with personal behavioral intentions is important. Individual autonomy refers to one's multidimensional awareness. When a top manager adopts a low monitoring attitude within an organization, high individual autonomy will be promoted and business performance will suffer. Hence, individual autonomy not only represents personal beliefs and characteristics but also fosters attitude formation. Attitude constitutes the main foundation of the social psychology framework. Attitude change is related to

other concepts, objects, or goals and estimates the aspect of interrelated beliefs. Thus, research infers that the knowledge-sharing attitude of optometry employees is influenced by individual autonomy. Organizational collaboration is a critical factor and the norm for organizations when facing a turbulent environment and competing for superiority. Organizations face business diversity and uncertain circumstances; thus, organizational collaboration enables department managers to create a friendly work environment, which leads to a successful business. Organizational collaboration is defined as an activity in which the interflow of information from organizations, including employee knowledge and resource sharing, enhances the capacity of workers for mutual reciprocity and the sharing of risk, reward, and responsibility [3].

Attention has recently been devoted to fostering organizational collaboration to promote employees' individual and organizational goals and translate these goals to personal behavioral awareness. The synthesis of personal perception and professional efficacy is expected to leverage the synergy of organizational collaboration to contribute to the industry. Prior studies mentioned that professional requirements for employees directly influence perceived behavioral control regarding knowledge-sharing intention. The manner in which employees engage work demand (i.e., product or service) should be made an indispensable capacity in organizations [2]. Studies confirm that professional requirements always play important roles in influencing the ratio of success of perceived behavioral control to knowledge-sharing intention.



This study integrates three antecedents and the theory of planned behavior as bases to examine the knowledge-sharing intentions of optometry employees [5]. Based on this literature review, a research model is proposed (Figure 1).

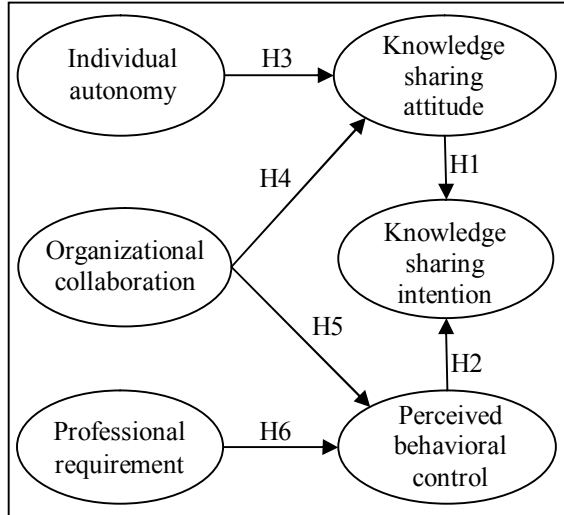


Figure 1. Research model

**3. Methodology**

This section describes the sample data obtained from optometry industry employees and verifies the knowledge-sharing intention of these employees.

**3.1 Sample and collection**

This study gathered data from a random sample of 187 optometry employees in the optometric industry of Taiwan. The survey data used demographic information and related constructs as measurement items in the questionnaires. A pretest was administered by four optometry experts to determine the validity of the contexts and semantics of the research questionnaires. A pilot study was conducted in 10 optometry industries with 20 respondents. Thereafter, formal questionnaires with cover letters were distributed to 460 optometry employees in Taiwan. Of the 221 usable questionnaires returned, 34 were not completed and had to be discarded. The remaining 187 questionnaires were analyzed. Twenty measurement items were derived from existing literatures and revised for the survey. Responses to the measurement items were made on a 5-point Likert scale (1 = strongly disagree, 5 = strongly agree). Demographic details based on the valid questionnaires are presented in Table 1.

Table 1. Sample description (n =187)

Measure	Items	Frequency	Percentage (%)
Gender	Male	124	66.31%
	Female	63	33.69%
Age	21~29	22	11.76%
	30~39	46	24.60%
	40~49	76	40.64%
	50~59	35	18.72%
	59 (or above)	8	4.28%
Qualification	Specialty school	95	50.80%
	Bachelor	85	45.45%
	Master	7	3.74%
Department	Optical shop	137	73.26%
	Eye clinic	28	14.97%
	Hospital . factory	16 6	8.56% 3.21%
Job position	Employee	158	84.49%
	Team leader	18	9.63%
	Manager	11	5.88%
Experience	Under 5 years	30	14.44%
	6~9 years	25	16.58%
	10~14 years	80	42.25%
	15~20 years	50	18.18%
	20years (or above)	13	8.56%

**3.2 Statistical analysis**

This study estimated the sample and analysis variables using SPSS 12.0 and LISREL 8.52. Explanatory and confirmatory factor analyses were conducted. Thereafter, structure path modeling was performed to determine the fitness of the model [6].

**4. Results**

**4.1 Hypothesis testing**

The results of the LISREL analysis are illustrated in Table 1 and Figure 2. The 20 measurement items are all above standard according to the exploratory factor analysis (factor loading > 0.786), reliability analysis (alpha value > 0.842), and confirmatory factor analysis (model fit index > 0.800). The individual autonomy variable has a significant negative relationship with knowledge-sharing attitude (H3) among optometry employees. Individual autonomy in the optometry industry does not motivate optometry employees' to share knowledge to co-workers. The dearth of individual autonomy among employees decreases the quality of management. Accordingly, optometry supervisors should strive to create a friendly work environment and relax routine management control to foster individual autonomy and strengthen knowledge sharing. The remaining hypotheses (H1, H2, H4, H5, and H6) show significant positive relationships with dependent variables. The findings imply that organizational collaboration, professional requirement, and perceived behavioral control provide effective explanatory power.

Table 2. Reliability and validity analysis

Construct	EFA	RA	CFA
Individual autonomy	IA3 0.898	0.932	P value=0.137 Chi-square=155.230 GFI=0.919 AGFI=0.888 RMSEA=0.027
	IA4 0.889		
	IA2 0.880		
Organizational collaboration	OI2 0.849	0.930	
	OI1 0.848		
	OI4 0.826		
Professional requirement	PR4 0.859	0.920	
	PR3 0.849		
	PR2 0.843		
Perceived behavioral control	PB2 0.802	0.842	
	PB3 0.800		
	PB1 0.786		
Knowledge sharing attitude	KT2 0.816	0.942	
	KT4 0.810		
	KT1 0.776		
Knowledge sharing intention	KS2 0.882	0.909	
	KS3 0.846		
	KS1 0.798		

factors are able to predict the knowledge-sharing intention of optometry employees. Managers in the optometry industry should adopt these factors to improve the formulation and implementation of strategies in accordance with the goal of rewarding knowledge-sharing intention among optometry employees.

**References**

1. Ajzen, I. (2002). Perceived behavioral control, self-efficacy, locus of control, and the theory of planned behavior. *Journal of Applied Social Psychology*, 32(4): 665-683.
2. Demian Whiting, D. (2009). Should doctors ever be professionally required to change their attitudes? *Clin Ethics*, 4(2): 67-73.
3. Zhen, L., Jiang, Z., & Song, H. T. (2011). Distributed knowledge sharing for collaborative product development. *International Journal of Production Research*, 49(10): 2959-2976.
4. Bock, G. W., Zmud, R. W., Kim, Y. G., & Lee, J. N. (2005). Behavioral intention formation in knowledge sharing: Examining the roles of extrinsic motivators, social-psychological forces, and organizational climate. *Mis Quarterly*, 29(1): 87-111.
5. Tsai, M. T., & Chen, K. S. (2012). Determinants of medical care service personnel knowledge sharing intention: an empirical study. *Life Science Journal*, 9(1): 782-784
6. Hair, J. F., Anderson, R. E., Tatham, R. L., & Black, W. C. (1995). *Multivariate data analysis*. In (Vol. 4th Ed). NJ.: Englewood Cliffs, Prentice Hall.

11/11/2012

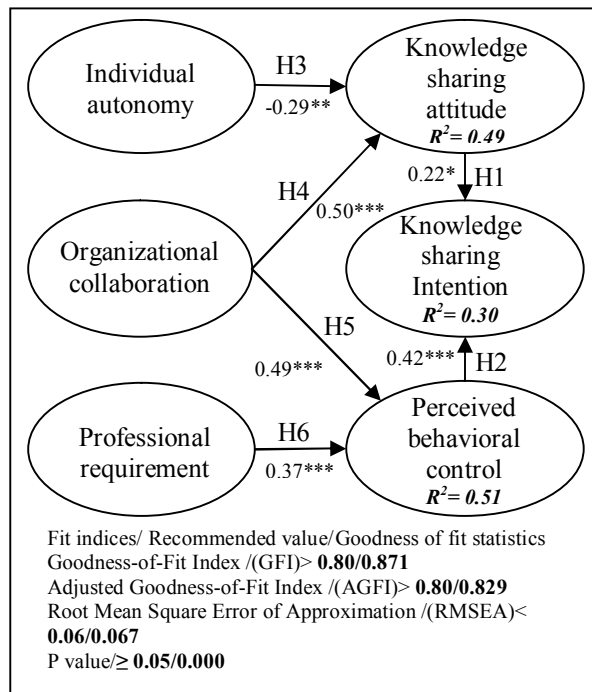


Figure 2. Results of structural model

**5. Conclusion and implication**

This study combined personal extrinsic and intrinsic factors with the theory of perceived behavior to explore the knowledge-sharing intentions of optometry employees in the optometric industry of Taiwan. Individual autonomy has a direct impact on knowledge-sharing attitude. Therefore, supervisors in the optometry industry should consider developing self-awareness among employees as a key element in fostering knowledge-sharing attitudes and knowledge-sharing intentions. The abovementioned

## Evaluation of correlation between serum immunoglobulin levels and extent of hepatic fibrosis in patients with chronic B hepatitis

Rasoul Estakhri<sup>1</sup>, Mohammad Hossein Somi<sup>2</sup>, Abdolreza TabanSadeghi<sup>1</sup>, Babak Hajipour<sup>3</sup>, Faeghe Tajallayi<sup>3</sup>.

<sup>1</sup>Department of Pathology, Tabriz university of medical sciences.

<sup>2</sup>Liver and gastroenterology research center, Tabriz university of medical sciences.

<sup>3</sup>Department of Surgery, Urmia University of Medical Sciences, Urmia, Iran.

<sup>4</sup>Faculty of Medicine, Tabriz Branch, Islamic Azad University, Tabriz-Iran

Corresponding author: Babak Hajipour, Post box: 51385-3633; Tel: +98-9141075936; [Hajipourb@yahoo.com](mailto:Hajipourb@yahoo.com)

**Abstract:** Background: Hypergammaglobulinaemia is a common finding in patients with chronic liver diseases. The mechanism is thought to involve reduced Kupffer cell clearance of antigens delivered, resulting in stimulate activity and proliferation of stellate cells and at least fibrogenesis. The aim of this study was to evaluate the correlation between serum immunoglobulin levels and possibility of use this noninvasive markers to determination of extent of hepatic fibrosis. Methods and materials: In this sectional study 50 chronic B hepatitis patients with positive virological markers and 50 people (normal control) selected from Tabriz Emam hospital during 2006-2009 and their serum IgG, IgM, IgA, serum glutamic oxaloacetic transaminase (SGOT), serum glutamic pyruvic transaminase (SGPT), alkaline phosphatase (ALP), Total protein, total bilirubin and albumin in both groups with immunoturbidometric assay and comparison with liver biopsies specimen that scoring with modified Knodell and statistical analysis was performed. Results: Results of study show significant prediction between serum total IgG ( $P < 0.00001$ ) and immunoglobulins ( $P < 0.0001$ ) levels with extent of liver fibrosis, but similar relation with another serum markers specially IgA and IgM not found. Conclusion: Total immunoglobulins and IgG serum levels had significant independent prediction of necro-inflammatory and extent of liver fibrosis but other markers did not had this relation. Also we can use total immunoglobulins and IgG serum levels as a predictor of liver fibrosis and a noninvasive method to replacement of invasive liver biopsy method.

[Rasoul Estakhri, Mohammad Hossein Somi, Abdolreza TabanSadeghi, Babak Hajipour, Faeghe Tajallayi.

**Evaluation of correlation between serum immunoglobulin levels and extent of hepatic fibrosis in patients with chronic B hepatitis.** *Life Sci J* 2012;9(4):2969-2974]. (ISSN: 1097-8135). <http://www.lifesciencesite.com>. 436

**Keywords:** serum immunoglobulin, hepatic fibrosis, B hepatitis

### 1. Introduction

Liver fibrosis is considered to be the result of the wound healing responses to chronic liver injury caused by chronic viral hepatitis, alcoholic hepatitis, non-alcoholic steatohepatitis, hemochromatosis, or autoimmune hepatitis, which result in hepatocyte damage and abnormal proliferation (Lee et al, 2010), (Khedmat et al, 2007), (Okpalugo et al, 2008).

The development of hepatic fibrosis in patients with liver disease is associated with cirrhosis and an increased risk of liver cancer. Assessing the degree of hepatic fibrosis and is therefore one of the most important factors in treatment planning (Hotta et al, 2007).

Hepatitis B virus (HBV) infection is the most common cause of acute and chronic liver disease worldwide, eventually progressing from fibrosis to cirrhosis and/ or hepatocellular carcinoma. An estimated 400 million people worldwide are carriers of HBV infection. Compensated chronic hepatitis progresses to cirrhosis in 12–20% of patients, and compensated cirrhosis progresses to hepatic decompensation and hepatocellular carcinoma with in 5 years in 20–25% and 6–16% of patients

respectively (Fattovich et al, 1991), (Ikeda et al, 1998), (Befeler et al, 2000), (Lok et al, 2001), (Liaw et al, 1988), (Yu et al, 1997). Approximately 250 000 deaths occur each year as a consequence of fulminant hepatic failure, cirrhosis and hepatocellular carcinoma (Befeler et al, 2000), (Schmilovitz-Weiss et al, 2006).

Liver biopsy is the gold-standard procedure, for determining the severity of necro-inflammatory activity and fibrosis, features potentially useful for predicting treatment response (Shiffman et al, 2003) and prognosis in Hepatitis C virus (HCV) (Shiffman et al, 2003). Repeated biopsies are performed in patients with recurrent HCV to estimate disease progression, to exclude other causes of elevated serum liver enzyme levels and to evaluate antiviral treatment response. but it is costly, invasive, and has inherent risks (morbidity 3%, mortality 0.03%) (Piccinino et al, 1986). In addition, sampling errors and intraobserver variations may lead to under staging of cirrhosis, particularly macronodular cirrhosis (Maharaj et al, 1986). Accordingly, alternative simple, accurate, and noninvasive tests are

needed to assess disease activity and fibrosis stage (Poynard et al, 2002), (Kim et al, 2007).

Although several serum-based markers have shown promise for the detection of advanced fibrosis (Callewaert et al, 2004), these tests, so far, are not commonly measured, and are extremely costly, and their sensitivities for milder stages of fibrosis (<2) are poor. Liver function tests are essential parts of assessing liver damage, but have poor correlation with histology (Hayes et al, 1990).

Hypergammaglobulinaemia is a common finding in patients with cirrhosis of various etiologies (Triger et al, 1973), (Triger et al, 1972), (Prytz et al, 1977), (Husby et al, 1977). The mechanism is thought to involve reduced Kupffer cell clearance of antigens delivered by the portal venous system, resulting in increased exposure to the systemic circulation and antibody producing sites (Triger et al, 1972), (Prytz et al, 1977). Consequently, elevated serum immunoglobulin levels have been thought to be a result rather than cause of cirrhosis (Triger et al, 1973), (Triger et al, 1972), (Prytz et al, 1977), (Husby et al, 1977), (Thomas et al, 1973), (Watt et al, 2004).

We carried out a comparative analysis of 50 patients with chronic liver diseases by comparing their serum biochemical markers with histopathological findings in liver biopsy, of patients with chronic liver diseases and the grading and staging of liver tissues, and to provide clues and basis for the noninvasive diagnosis of liver fibrosis.

## 2. Material and Methods

### Patients

In this research we had two groups: group 1: as control group, they had no elevation in liver enzymes and had negative viral markers, their serum sampled and stored at -70C. In the group 2, patients with chronic hepatitis B included. Patients with any other cause of chronic liver disease, rheumatic diseases, patients that may have had other types of fibrosis due to renal or pulmonary diseases, nonalcoholic steatohepatitis (NASH), auto immune hepatitis, drug poisoning and patients with malignancies were excluded. Liver biopsies were performed under ultrasonographic guidance.

### Histological assessment of liver damage

Fifty patients underwent a liver biopsy for assessing the presence and severity of liver disease. The biopsy fragments were fixed in a 10% formalin solution for 12 hours and embedded in paraffin. Sections were stained with hematoxylin-eosin, Masson's trichrome and reticulin stain (Parsian et al, 2010).

The original histology activity index proposed by Knodell (Knodell et al, 1981) was used for grading inflammation/necrosis and for staging fibrosis. By this scoring system inflammation/necrosis score ranges from 0 to 18 (0-10 periportal  $\pm$  bridging necrosis, 0-4 intralobular degeneration and focal necrosis, 0-4 portal inflammation), while fibrosis stage includes only four stages: 0 (no fibrosis), 1 (fibrous portal expansion), 3 (bridging fibrosis), 4 (cirrhosis). Steatosis was scored semi-quantitatively as: 0, no steatosis, 1, steatosis  $\leq$  33% of hepatocytes, 2, steatosis in 34%-66% of hepatocytes, 3, > 66% of hepatocytes.

### Biochemistry:

In all serum samples levels of Ig M, Ig G and Ig A were measured using auto analyzer (Abott Alycon). Also serum biochemical factors including ALP, SGOT, SGPT, albumin, total protein and total bilirubin were measured by commercial kits (Bashir et al, 2009).

According to manufacture instructions, the normal range for IgG was 700-1600 mg/dl, for IgM was 40-230 mg/dl and for IgA was 70-400 mg/dl.

### Statistics:

The SPSS 16 software was used for analysing the results and Student T test, Logistic linear and one way analysis of variance were used for comparing the groups and  $P < 0.05$  used as significant level for comparing the groups.

## 3. Results

These results were obtained considering markers and lab tests after taking biopsies from patients and their serum reserves that were gained for routine lab tests before biopsies and also from normal people's serum reserves.

Personal and biochemical specifications of the patients are mentioned in the table 1. The patients group mean age was  $47.78 \pm 11.84$  and the control group mean age was  $43.76 \pm 9.29$ . In the patients group 26 were female and 24 were male and in control group, 32 were female and 18 were male. The results showed that the levels of total immunoglobulin, IgG, IgM, IgA, total bilirubin, albumin and total protein were higher in hepatitis B patients comparing to control group significantly ( $P < 0.0001$ ). The ALP level was higher in patients group comparing to control group significantly ( $P < 0.005$ ), but there was no difference in SGPT and SGOT levels between two groups.

Among patients, 24 patients were mild, 20 were moderate and 6 were severe. Analysis of serum IgG level in comparison between the mild group with the moderate group and between the mild group with the severe one and between the moderate groups with the

severe one had significant difference ( $P < 0.0001$ ) and has a high predictive value.

Table 1. Serum biochemical profile of patients group and control group.

Control group	Patients group	Age
43.76 ± 9.29	48.91 ± 8.65	
32(64)	26(52)	Gender(female)
971.78 ± 201.41	2375.42 ± 1046.43	IgG (mg/dl)
98.46 ± 38.78	215.92 ± 93.72	IgM(mg/dl)
5.66 ± 1.86	311.80 ± 70.84	IgA(mg/dl)
8.13 ± 0.92	5.66 ± 1.86	Total Protein(mg/dl)
24.24 ± 19.61	24.02 ± 21.01	SGOT(IU/L)
18.90 ± 13.08	21.44 ± 18.03	SGPT(IU/L)
126.76 ± 51.76	186.32 ± 155.99	ALP(IU/L)
0.54 ± 0.39	2.41 ± 1.76	Total bilirubin(mg/dl)
4.38 ± 0.51	3.07 ± 0.78	Albumin(mg/dl)
1256.44 ± 214.25	2903.14 ± 1071.69	Total immunoglobulin(mg/dl)

But other immunoglobulins did not show significant differences between different groups with different intensities. There is significant difference among mild, moderate and severe groups only considering total immunoglobulin and IgG levels that showed this significant difference ( $P < 0.0001$ ) but other markers do not have this predictive value (Table 2).

Table 2. Serum biochemical profile of patients with different grade of liver tissue fibrosis.

Severe	Moderate	Mild	Total immunoglobulin(IU/L)
4848.01 ± 505.24	3182.05 ± 772.81	2184.51 ± 552.01	
4264.83 ± 60.55	2644.1 ± 749.19	1679.16 ± 523.87	IgG(mg/dl)
287.83 ± 209.10	217.95 ± 77.26	196.25 ± 50.21	IgM(mg/dl)
295.33 ± 73.89	320 ± 68.63	309.08 ± 74.01	IgA(mg/dl)
6 ± 1.77	5.43 ± 1.95	5.77 ± 1.86	Total protein(mg/dl)
20.51 ± 8.51	18.1 ± 9.48	29.83 ± 9.84	SGOT(IU/L)
13.83 ± 6.58	14.25 ± 6.17	29.33 ± 6.26	SGPT(IU/L)
193.1 ± 101.81	156.05 ± 103.86	209.88 ± 155.63	ALP(IU/L)
2.07 ± 1.04	2.76 ± 1.73	2.21 ± 2.09	Total Bilirubin(mg/dl)
3.06 ± 0.87	3.21 ± 0.7	2.96 ± 0.85	Albumin(mg/dl)

About the relation of different markers with each other Pierson correlation test was used.

Analysis of serum IgG level amounts has significant and direct relation with IgM ( $P < 0.0001$ ). Also it has significant and direct relation with IgA ( $P < 0.0001$ ).

IgG has a significant but reversed relation ( $P < 0.0001$ ) with albumin and has the same relation ( $P < 0.0001$ ) with total protein and Ig M, also analysis of serum level amounts showed that with Ig A there is a very significant ( $P < 0.0001$ ) and direct relation. Also IgM has a significant and reversed relation with total protein ( $P < 0.0001$ ) and albumin ( $P < 0.0001$ ) but there isn't any significant relation ( $P > 0.05$ ) with SGOT, SGPT, ALP and total bilirubin. Analysis of IgA serum level amounts showed that IgA has a

reversed and very significant relation with total protein ( $P < 0.0001$ ) and albumin ( $P < 0.0001$ ) and a reversed and insignificant relation with SGOT  $P > 0.05$  and also a direct insignificant relation with SGPT and ALP and a direct significant relation ( $P < 0.05$ ) with total bilirubin.

Serum total protein level amounts also has a direct significant relation with albumin ( $P < 0.0001$ ) and a reversed significant relation with total bilirubin ( $P < 0.05$ ) and a reversed insignificant relation with SGPT and ALP and  $P > 0.05$  and a direct insignificant relation with SGOT and ALP.

SGOT didn't have any significant relation with any of the markers except IgG that has a reversed insignificant relation and with others, this relation was direct and insignificant ( $P > 0.05$ ). Analysis of serum SGPT level amounts also showed that like SGOT it didn't have significant relation with analyzed markers and like that it had a reversed insignificant relation just with IgG. The present study showed that ALP also doesn't have any significant relation with any of the markers ( $p > 0.05$ ) and with SGPT and total bilirubin and albumin, this relation was reversed and insignificant. Also total bilirubin had a direct significant relation with IgA and IgG and a reversed significant relation with total protein and albumin ( $P < 0.005$ ).

Albumin also according to the mentioned data had a reversed significant relation with IgG, IgM, IgA and total bilirubin and a direct significant relation with total protein. Also it showed a reversed insignificant relation with other markers.

Analysis of linear regression showed that the level of IgG with  $P < 0.0001$  has a significant relation with the stage but IgM with  $P > 0.05$  doesn't have a significant relation with the stage. Also IgA with  $P = 0.21$  doesn't have a significant relation with the stage. Also linear regression showed that IgG level with  $P < 0.0001$  has a significant relation with the grade and IgM and IgA with  $P > 0.05$  don't have these significant relations with the grade. ANOVA statistical analysis shows that total immunoglobulin level has a significant relation ( $P < 0.0001$ ) between the groups.

Also POST HOC tests analysis by the Tukey method showed that between the mild group with the moderate group ( $P < 0.0001$ ) and the mild group and the severe one ( $P < 0.0001$ ), there is a very significant relation. Also between the moderate group and the severe one this significant relation was detected. About the relation of total immunoglobulin with the other markers, the obtained results showed that total immunoglobulin had a reversed significant relation with total protein ( $P < 0.0001$ ) and a reversed

insignificant relation with  $P > 0/05$  and a relative  $r$  about  $- 0/66$  with SGOT and SGPT.

Also it had a reversed significant relation with albumin ( $P < 0.0001$ ) and a direct significant relation with total bilirubin ( $P > 0.05$ ) but it didn't have any significant relation with ALP.

In the study of relation of immunoglobulin levels with the severity of liver fibrosis, statistical analysis with linear regression showed that only total immunoglobulin level ( $P < 0.0001$ ) and IgG ( $P < 0.0001$ ) are predictive of disease severity.

#### 4. Discussions

In this study, we evaluated the relation between serum immunoglobulin levels and fibrosis stages in hepatitis B patients and the possibility of substitution of a noninvasive method that can be repeated (which can have markers) with the invasive method of liver needle biopsy. In this study 48 percent of the patients according to the severity of liver fibrosis were in the mild group, 40 percent were in the moderate group and 12 percent were in the severe group.

In liver cirrhosis, liver injury is accompanied by a characteristic increase in serum levels of IgA, IgG and IgM, the origin of which remains to be elucidated fully. In Recent results from two animal studies suggest that immunoglobulins may play an important role in the pathogenesis of hepatic fibrosis (Shen et al,2001) ,(Yokoyama et al,1995). In a study by Yokoyama et al. Yokoyama et al,1995). ethanol alone was reported to have limited fibrogenic properties when administered to adult guinea pigs. However, when administered in conjunction with IgA immunoglobulins, extensive hepatic fibrosis occurred.

Our results suggested a very significant relation between liver fibrosis staging with IgG and IgA level, but no significant relation could be found with serum IgM level. The severity of fibrosis (grade) also had a very significant relation with IgG level ( $P = 0.001$ ) but there wasn't any significant relation with serum IgM and IgA levels.

Watt et al (Watt et al,2004), indicated that Ig M levels didn't correlate with fibrosis grade, our in vitro data indicate that rat hepatic stellate cells possess Fc receptors (which bind to IgA and IgG but not IgM immunoglobulins). Whether complement receptors (required for IgM immunoglobulin binding) also exist in this cell population has yet to be determined. However, their results showed that there is a significant correlation between fibrosis and serum Ig A levels. In the present study Ig level and total immunoglobulin showed a more significant and direct relation with liver fibrosis staging ( $P < 0.0001$ )

and other markers levels did not have any significant relation.

Schmilovitz-Weiss H et al (Schmilovitz-Weiss et al, 2006) showed that there is a strong association between serum levels of globulin and IgG and extent of hepatic fibrosis in patients with chronic HBV infection. These simple laboratory measurements can serve as noninvasive markers for disease progression. Also Pradat et al (Pradat et al,2002) in a study by the title of the predictive value of serum level of liver enzymes in histologic findings of patients suffering from C hepatitis came in to conclusion that there is an apparent relation between IgG and IgA and total immunoglobulin with fibrosis severity. Also SGOT showed a significant relation with liver fibrosis severity. This study showed that this significant relation also exists with inflammation severity (grade). But in this present study this relation did not exist about liver enzymes, neither in staging nor in grading.

Wai et al (Wai et al, 2003) also in a study for the reason of studying the power of noninvasive indicators in predicting fibrosis severity and cirrhosis in patients with C hepatitis showed that serum SGOT level is considered a useful predictive factor in C hepatitis. But in the present study serum SGOT and SGPT amounts did not show a significant value with liver fibrosis.

HUI et al (Hui et al,2005) also showed that the markers like bilirubin and albumin have useful predictive value in determining liver fibrosis severity in patients with B hepatitis.

Also he mentioned that albumin can be a prognostic factor in these patients survival.

But in the present study this significant relation was not detected with bilirubin and albumin. Schmilovitz-Weiss et al (Schmilovitz-Weiss et al,2007), reported that, there is a strong association between serum globulin and immunoglobulins levels and extent of hepatic fibrosis in patients with recurrent HCV infection after liver transplantation. Serum globulin and certain immunoglobulins level can serve as a non-invasive marker following antiviral treatment.

At present, the diagnosis of liver fibrosis still depends on pathological examination of liver biopsy. Since the procedure is invasive, its application and extensive use in clinical practice are still limited. So great attention has been paid to search for and clinical study of a non-invasive diagnostic parameter for liver fibrosis (Thabut et al,2003), It would not only speed up the study of basic medical theory about liver disease, but also be of value (Botta et al, 2003). Our study indicated that there is significant relation between Ig G level and fibrosis grade in hepatitis B patients.

**Authors' Contribution**

Rasoul Estakhri and Mohammad Hossein Somi designed and supervised the study, Mehdi Abdolreza Taban Sadeghi studied pathologic findings, Babak Hajipour collected the data and wrote the paper. Faeghe Tajallayi contributed to the analyzing and interpreting the data. All authors read and approved the final revision.

**References:**

1. Bashir K, Hussain N, Hasnain S, Elahi S, 2009. Seroprevalence of hepatitis E virus immunoglobulin G and M antibodies in adults: a hospital-based study. *Indian J Med Microbiol.* 27(2):139-41.
2. Befeler A, DiBisceglie A, 2000. Hepatitis B. *Dis Clin North Am*; 14: 617-632.
3. Callewaert N, Van Vlierberghe H, Van Hecke A, Laroy W, Delanghe J, Contreras R, 2004. Noninvasive diagnosis of liver cirrhosis using DNA sequencer-based total serum protein glycomics. *Nat Med*: 10: 429.
4. Botta F, Giannini E, Romagnoli P, Fasoli A, Malfatti F, Chiarbonello B, Testa E, Risso D, Colla G, Testa R, 2003. MELD scoring system is useful for predicting prognosis in patients with liver cirrhosis and is correlated with residual liver function: a European study. *Gut*; 52: 134-139
5. Fattovich G, Brollo L, Giustina G et al, 1991. Natural history and prognostic factors for chronic hepatitis type B. *Gut*; 32: 294-298.
6. Hotta N, Ayada M, Okumura A, Ishikawa T, Sato K, Oohashi T, Hijikata Y, Murayama S, Ido M, Kakumu S, 2007. Noninvasive assessment of liver disease - measurement of hepatic fibrosis using tissue strain imaging. *Clin Imaging*; 31(2):87-92.
7. Hui AY, Chan HL, Wong VW, Liew CT, Chim AM, Chan FK, Sung JJ, 2005. Identification of chronic hepatitis B patients without significant liver fibrosis by a simple noninvasive predictive model. *Am J Gastroenterol.*; 100(3):616-23.
8. Ikeda K, Saitoh S, Suzuki Y et al, 1998. Disease progression and hepatocellular carcinogenesis in patients with chronic viral hepatitis: a prospective observation of 2,215 patients. *J Hepatol*; 28: 930-938.
9. Kim BK, Kim SA, Park YN, Cheong JY, Kim HS, Park JY, Cho SW, Han KH, Chon CY, Moon YM, Ahn SH, 2007. Noninvasive models to predict liver cirrhosis in patients with chronic hepatitis B. *Liver Int.*; 27(7):969-76.
10. Knodell RG, Ishak KG, Black WC, Chen TS, Craig R, Kaplowitz N, Kiernan TW, Wollman J, 1981. Formulation and application of a numerical scoring system for assessing histological activity in asymptomatic chronic active hepatitis. *Hepatology.*; 1:431-435
11. Hayes PC, Thomas P, Bouchier IA, Piris J, 1990. Biochemistry and histology in chronic liver disease. *Clin Chem Enzym Commun*, 3:245-250.
12. Husby G, Skrede S, Blomhoff JP, Jacobsen CD, Berg K, Gjone E, 1977. Serum immunoglobulins and organ non-specific antibodies in diseases of the liver. *Scand J Gastroenterol*; 12: 297-304.
13. Khedmat H, Fallahian F, Abolghasemi H, Alavian SM, Hajibeigi B, Miri SM, Jafari AM, 2007. Seroepidemiologic study of hepatitis B virus, hepatitis C virus, human immunodeficiency virus and syphilis infections in Iranian blood donors. *Pak J Biol Sci.* Dec 15;10(24):4461-6.
14. Lee KG, Seo YS, An H, Um SH, Jung ES, Keum B, Yim HJ, Jeon YT, Chun HJ, Kim CD, Ryu HS, 2010. Usefulness of non-invasive markers for predicting liver cirrhosis in patients with chronic hepatitis B. *J Gastroenterol Hepatol.*; 25(1):94-100.
15. Liaw YF, Tai DL, Chu CM, Chen TJ, 1988. The development of cirrhosis in patients with chronic type B hepatitis: a prospective study. *Hepatology* 1988; 8: 493-496.
16. Lok AS, McMahon BJ, 2001. Chronic hepatitis B. *Hepatology*; 34: 1225-1241.
17. Maharaj B, Maharaj RJ, Leary WP, et al, 1986. Sampling variability and its influence on the diagnostic yield of percutaneous needle biopsy of the liver. *Lancet*; 1: 523-5.
18. Okpalugo CE, Oguntibeju OO, 2008. Prevalence of human immunodeficiency virus and hepatitis B virus in preoperative patients: potential risk of transmission to health professionals. *Pak J Biol Sci.* Jan 15;11(2):298-301.
19. Parsian H, Rahimpour A, Nouri M, Somi MH, Qujeq D, 2010. Assessment of liver fibrosis development in chronic hepatitis B patients by serum hyaluronic acid and laminin levels. *Acta Clin Croat.*; 49(3):257-65.
20. Piccinino F, Sagnelli E, Pasquale G, Giusti G, 1986. Complications following percutaneous liver biopsy. A multicentre retrospective study on 68,276 biopsies. *J Hepatol*; 2: 165-73.
21. Poynard T, Imbert-Bismut F, Ratziu V, et al, 2002. Biochemical markers of liver fibrosis in patients infected by hepatitis C virus:

- longitudinal validation in a randomized trial. *J Viral Hepatol* 2002; 9: 128–33.
22. Pradat P, Alberti A, Poynard T, Esteban JI, Weiland O, Marcellin P, Badalamenti S, Trépo C, 2002. Predictive value of ALT levels for histologic findings in chronic hepatitis C: a European collaborative study. *Hepatology*;36(4 Pt 1):973-7.
  23. Prytz H, Bjorneboe M, Christoffersen P, Poulsen H, Orskov F, 1977. Correlation between hepatic morphology and immunoglobulins and antibodies to *Escherichia coli* in cirrhosis. *Gut*; 18: 28–32.
  24. Schmilovitz-Weiss H, Cohen M, Pappo O, Sulkes J, Braun M, Tur-Kaspa R, Ben-Ari Z, 2007. Serum globulin levels in predicting the extent of hepatic fibrosis in patients with recurrent post-transplant hepatitis C infection. *Clin Transplant*;21(3):391-7.
  25. Schmilovitz-Weiss H, Tovar A, Halpern M, Sulkes J, Braun M, Rotman Y, Tur-Kaspa R, Ben-Ari Z, 2006. Predictive value of serum globulin levels for the extent of hepatic fibrosis in patients with chronic hepatitis B infection. *J Viral Hepat* ;13(10):671-7.
  26. Shen H, Huang G, Zhang M, Kaita K, Minuk G, Gong Y, 2001. Effects of immunoglobulin G on the proliferation and activation of sub-cultured rat hepatic stellate cells. *Hepatology*; 34: 403.
  27. Shiffman ML, 2003. Natural history and risk factors for progression of hepatitis C virus disease and development of hepatocellular cancer before liver transplantation. *Liver Transpl*;9(11):S14-20.
  28. Thabut D, Simon M, Myers RP, Messous D, Thibault V, Imbert- Bismut F, Poynard T, 2003. Noninvasive prediction of fibrosis in patients with chronic hepatitis C. *Hepatology*; 37: 1220-1221.
  29. Thomas HC, McSween RNM, White R, 1973. Role of the liver in controlling the immunogenicity of commensal bacteria in the gut. *Lancet*; 1: 1288–1291.
  30. Triger DR, Alp MH, Wright R, 1972. Bacterial and dietary antibodies in liver disease. *Lancet*; 1: 60–63.
  31. Triger DR, Wright R, 1973. Hypergammaglobulinemia in liver disease. *Lancet*; 1: 1494.
  32. Wai CT, Greenon JK, Fontana RJ, Kalbfleisch JD, Marrero JA, Conjeevaram HS, Lok AS, 2003. A simple noninvasive index can predict both significant fibrosis and cirrhosis in patients with chronic hepatitis C. *Hepatology*;38(2):518-26.
  33. Watt K, Uhanova J, Gong Y, Kaita K, Doucette K, Pettigrew N, Minuk GY, 2004. Serum immunoglobulins predict the extent of hepatic fibrosis in patients with chronic hepatitis C virus infection. *J Viral Hepat*;11(3):251-6.
  34. Yokoyama H, Nagata S, Moriya S et al, 1995. Hepatic fibrosis produced in guinea pigs by chronic ethanol administration and immunization with acetaldehyde adducts. *Hepatology*; 21(5): 1438–1442.
  35. Yu MW, Hsu FC, Sheen IS, Chu CM, Lin DY, Chen CJ, Liaw YF, 1997. Prospective study of hepatocellular carcinoma and liver cirrhosis in asymptomatic chronic hepatitis B virus carriers. *Am J Epidemiol*; 145: 1039–1047..

9/6/2012



## Higher-order asymptotic formula for the eigenvalues of Sturm-Liouville problem with indefinite weight function in the Neumann boundary condition

Farhad Dastmalchi Saei<sup>1</sup>, A. Jodayree Akbarfam<sup>2</sup>

1. Department of Mathematics, Tabriz Branch, Islamic Azad University, Tabriz, Iran

2. Faculty of Mathematical Sciences Tabriz University, Tabriz, Iran

E-Mail: [dastmalchi@iaut.ac.ir](mailto:dastmalchi@iaut.ac.ir); E-Mail: [akbarfam@ark.tabrizu.ac.ir](mailto:akbarfam@ark.tabrizu.ac.ir)

**Abstract:** In this paper, we investigate the asymptotic behavior of the differential equation

$y'' + (\lambda r(x) - q(x))y = 0$ ,  $0 \leq x \leq 1$ . Where  $[0,1]$  contains a finite number of zeros of  $r(x)$ , the so called turning points,  $\lambda$  is a real parameter and the function  $q(x)$  is bounded and integrable in  $[0,1]$ . Using a technique used previously in [7], we derive the higher-order asymptotic distribution of the positive eigenvalues associated with this equation for the Neumann problem (i.e.  $y'(0) = y'(1) = 0$ ). In most differential equations with variable coefficient it is impossible to obtain an exact solution, so we want to obtain asymptotic distribution of the eigenvalues without solving equation.

[Farhad Dastmalchi Saei, A. Jodayree Akbarfam. **Higher-order asymptotic formula for the eigenvalues of Sturm-Liouville problem with indefinite weight function in the Neumann boundary condition.** *Life Sci J* 2012;9(4):2975-2979]. (ISSN: 1097-8135). <http://www.lifesciencesite.com>. 437

**Keywords:** turning point, Sturm-Liouville, nondefinite, asymptotic distribution, eigenvalue.

AMS Sub. Classification: 34L20.

### 1. Introduction

We study the indefinite Sturm-Liouville spectral problem

$$y'' + (\lambda r(x) - q(x))y = 0, \quad a \leq x \leq b \quad (1)$$

$$y'(a) = y'(b) = 0,$$

defined on the interval  $[a, b]$  where  $\lambda$  is a real parameter,  $r(x), q(x)$  are real and integrable on  $[a, b]$ ; moreover,

$$\int_a^b \sqrt{r_+(t)} dt > 0, \text{ where } r_+(x) = \max\{r(x), 0\}. \quad (2)$$

It follows from [2] that the spectrum of this problem is discrete and has no finite accumulation points; moreover, only finitely many eigenvalues lie the outside the real and imaginary axes. In what follows, we shall assume that  $\lambda$  is a positive parameter. In [4] it was shown that the asymptotics of the eigenvalues is of the form

$$\lambda_n \sim \frac{n\pi}{\int_a^b \sqrt{r_+(t)} dt}. \quad (3)$$

Our goal is to refine the asymptotics under the additional assumptions of smoothness of the functions  $r(x)$  and  $q(x)$ . In addition, we assume that  $r(x)$  has a finite number of zeros, which are called turning points.

The outline of our paper is as follows. First, we find the asymptotics of eigenvalues for one turning point. Next,

using a technique previously in [9], we derive the higher order asymptotic distribution of the positive eigenvalues in the case of two turning points. Finally, in the case of an arbitrary finite number of turning points it can be reduced to the two cases discussed above.

### 2. The case of one turning point

First, consider the case

$$r(x) = (x - x_v)^{l_v} h(x), h(x) > 0.$$

To simplify the formulas, we assume that  $x$  varies on the closed interval with endpoints  $a$  and  $b$ , where  $r(a) < 0$  and  $r(b) > 0$ . The turning point  $x_v$  lies between  $a$  and  $b$ .

We distinguish four different types of turning points:

$$T_v = \begin{cases} I & \text{if } l_v \text{ is even and } r(x) < 0 \text{ in } [a, b] \\ II & \text{if } l_v \text{ is even and } r(x) > 0 \text{ in } [a, b] \\ III & \text{if } l_v \text{ is odd and } r(x) < 0 \text{ in } [x_v, b] \\ IV & \text{if } l_v \text{ is odd and } r(x) > 0 \text{ in } [x_v, b] \end{cases}$$

is called of type  $x_v$ . By Langer's transformation we can make zero of  $r(x)$  the origin. To be specific, let us define the Langer's transformation  $\xi(x)$  for different type of TP.

For a turning point of Type I :

$$\xi_I(x) = \begin{cases} -\left\{ \int_x^{x_v} (-r)^{1/2}(t) dt \right\}^{\frac{2}{l+2}} & x \leq x_v \\ -\left\{ \int_{x_v}^x (-r)^{1/2}(t) dt \right\}^{\frac{2}{l+2}} & x_v \leq x. \end{cases} \quad (4)$$

For a turning point of Type II :

$$\xi_{II}(x) = \begin{cases} \left\{ \int_x^{x_v} r^{1/2}(t) dt \right\}^{\frac{\pi}{\ell+2}} & x \leq x_v \\ \left\{ \int_{x_v}^x r(t)^{1/2} dt \right\}^{\frac{\pi}{\ell+2}} & x_v \leq x. \end{cases} \quad (5)$$

For a turning point of Type III :

$$\xi_{III}(x) = \begin{cases} \left\{ \int_x^{x_v} r^{1/2}(t) dt \right\}^{\frac{\pi}{\ell+2}} & x \leq x_v \\ -\left\{ \int_{x_v}^x (-r(t))^{1/2} dt \right\}^{\frac{\pi}{\ell+2}} & x_v \leq x. \end{cases} \quad (6)$$

For a turning point of Type IV :

$$\xi_{IV}(x) = \begin{cases} -\left\{ \int_x^{x_v} (-r(t))^{1/2} dt \right\}^{\frac{\pi}{\ell+2}} & x < x_v \\ \left\{ \int_{x_v}^x (r(t))^{1/2} dt \right\}^{\frac{\pi}{\ell+2}} & x_v \leq x. \end{cases} \quad (7)$$

From [9] we rewrite showing the connection between the argument of complex valued solution of (1) in the interval containing one of the turning point say,  $x_v$ , and the argument of complex valued solution of Sturm-Liouville equation with one turning point in  $x = 0$  in the same interval. In fact the following result illustrates a crucial relationship between a general problem ((1)) with a turning point at  $x_v$  to a transformed problem in which is mapped to  $x = 0$ . We show that such a transformation preserves the argument of any fixed complex valued solution.

**Theorem 1** Let  $z$  be a strictly complex -valued solution of the differential equations

$$y'' + (\rho^2 r(x) - q(x))y = 0, x \in [0,1] \quad (8)$$

and  $W$  be a solution of

$$W'' + (u^2(-1)^{M_k} \xi^{\ell_v} - R_v(\xi))W = 0, \xi \in [c, d] \quad (9)$$

then on the interval  $[x_v - \varepsilon, x_v + \varepsilon]$

$$\arg W(\xi(x)) = \arg z,$$

where  $r(x) = \prod_{j=1}^n (x - x_j)^{1_j} \phi_0(x)$  and

$$R_v(\xi) = \left(\frac{dx}{d\xi}\right)^{1/2} \frac{d^2}{d\xi^2} \left\{ \frac{1}{\left(\frac{dx}{d\xi}\right)^{1/2}} \right\} + \left(\frac{dx}{d\xi}\right)^2 q(x(\xi)).$$

$M_k$  = the number of turning of type (III) or (IV) in

$(x_k, 1)$ , or one can see that

$$(-1)^{M_k} = (-1)^{1_k + \dots + 1_{k-1}}, \quad c < 0 < d,$$

$$u^2 = \frac{(\ell_v+2)^2}{4} \rho^2,$$

The transformation  $\xi(x)$  is Langer's transformation.

**Proof:** For proof see [9].

### 3. The main result

We begin by consolidating some results from [5,9] for completeness. For a complex-valued solution

$$\Omega(x, \lambda), \text{ of} \quad (E_0) \quad y'' + \lambda x^\alpha y = 0,$$

we form the logarithmic derivative  $r_0(x, \lambda) = \Omega'(x, \lambda)/\Omega(x, \lambda)$ , a quantity that exists for each  $x \in [a, b]$  since the real and imaginary parts of  $\Omega$  are linearly independent solution of  $(E_0)$ . The quantity  $r_1(x, \lambda)$  is defined by setting

$$r_1(x, \lambda) = - \int_x^b q(t) e^{2 \int_x^t r_0(s, \lambda) ds} dt,$$

while the  $r_n(x, \lambda)$  are defined recursively (for  $n \geq 1$ ) by

$$r_{n+1}(x, \lambda) = \int_x^b r_n^2(x, \lambda) \exp(2 \sum_{i=0}^n \int_x^t r_i(s, \lambda) ds) dt$$

It follows (cf. [4]) that the function

$$r(x, \lambda) = \sum_{n=0}^{\infty} r_n(x, \lambda) := S(x, \lambda) + iT(x, \lambda)$$

is a series solution (in  $x$ ) of the Riccati equation

$$v' = q - \lambda x^\alpha - v^2$$

from which one can reconstruct solutions of (1) with Neumann condition

$$y'(a) = y'(b) = 0 \text{ via the following result:}$$

**Theorem 2** (see Harris-Talarico[4]) There exists  $\lambda_0$  such that any real valued solution of

$$y'' + (\lambda x^\alpha - q(x))y = 0 \quad (10)$$

can be expressed as :

$$Z(x, \lambda) = c_1 e^{\int_a^x S(t, \lambda) dt} \cos(c_2 + \int_a^x T(t, \lambda) dt)$$

for  $x \in [a, b]$  ( $a < 0 < b$ ) and  $|\lambda| \geq \lambda_0$  where  $c_1, c_2 \in \mathfrak{R}$ . If  $Z(., \lambda)$  satisfies

$$y(a) \cos \gamma + y'(a) \sin \gamma = 0 \quad (11)$$

then

$$c_2 =: c_2^\alpha = \begin{cases} \frac{\pi}{2} & \text{if } \gamma = 0 \\ \arctan\left(\frac{1}{T(a, \lambda)} S(a, \lambda) + \cot \gamma\right) & \text{if } \gamma \neq 0 \end{cases} \quad (12)$$

Similarly, if  $Z$  satisfies

$$y(b) \cos \beta + y'(b) \sin \beta = 0 \quad (13)$$

then

$$c_2 =: c_2^\beta = \begin{cases} n\pi + \frac{\pi}{2} & \text{if } \beta = 0 \\ n\pi + \arctan\left(\frac{1}{T(b, \lambda)} S(b, \lambda) + \cot \beta\right) & \text{if } \beta \neq 0 \end{cases} \quad (14)$$

for all integer  $n$ .

It follows from (12) and (14) that the eigenvalues of (10),(11) and (13), i.e., our problem (1), are the values of  $\lambda$  for which

$$c_2^a + \int_a^b T(t, \lambda) dt = c_2^b \quad (15)$$

We see from [3], that the asymptotic distribution of the eigenvalues of (10),(11) and (13) is therefore determined by the following transcendental equation:

$$\begin{aligned} n\pi + \arctan\left(\frac{1}{T(b, \lambda)} S(b, \lambda) + \cot\beta\right) &= \\ \int_a^b T(t, \lambda) dt + \arctan\left(\frac{1}{T(a, \lambda)} S(a, \lambda) + \cot\gamma\right) & \\ = \Im \int_a^b r(t, \lambda) dt + \arctan\left(\frac{1}{T(b, \lambda)} S(b, \lambda) + \cot\gamma\right) & \\ = \Im \left( \int_a^b r_0(t, \lambda) dt + \int_a^b r_1(t, \lambda) dt + \dots \right) & \quad (16) \\ + \arctan\left(\frac{1}{T(a, \lambda)} S(a, \lambda) + \cot\gamma\right) & \\ = \arg\Omega(b, \lambda) - \arg\Omega(a, \lambda) - \frac{\pi}{2k} \int_a^b xq(x) J_k^2(k^{-1}\lambda^{1/2}x^k) dx + \dots & \\ + \arctan\left(\frac{1}{T(a, \lambda)} S(a, \lambda) + \cot\gamma\right). & \end{aligned}$$

Note that we use the following result from [8],

$$\Im \int_a^b r(t, \lambda) dt = \arg\Omega(b, \lambda) - \arg\Omega(a, \lambda) - \frac{\pi}{2k} \int_a^b xq(x) J_k^2(k^{-1}\lambda^{1/2}x^k) dx.$$

By applying the above relation to approximate eigenvalues in the case of  $\gamma = \beta = \frac{\pi}{2}$ .

**Theorem 3** Consider the differential equation (1) on  $[a, b]$  under condition (2). Then the positive eigenvalues admit the following asymptotic representation:

(a) Let  $x_\nu$  be of type IV. Then

$$\sqrt{\lambda_n} = \frac{n\pi}{\int_a^b \sqrt{r(t)} dt} - \frac{1}{n\pi} \left( \frac{4(\nu-1)^2-1}{8 \int_a^b \sqrt{r(t)} dt} - \frac{1}{2} H(b) \right) + o\left(\frac{1}{n}\right) \quad (17)$$

where

$$H(b) = \int_{x_\nu}^b \left( \frac{q(x)}{\tilde{r}(x)} - \frac{1}{\tilde{r}^{3/4}} \frac{d^2}{dx^2} (\tilde{r}^{-1/4}) \right) \frac{\tilde{r}^{1/2}}{r^{1/2}} dx,$$

and

$$\tilde{r} = \left( \frac{d\xi}{dx} \right)^2 = \frac{4r(x)}{(1+2)^2 (\xi(x))^4}$$

(b) Let  $x_\nu$  be of type III. Then

$$\sqrt{\lambda_n} = \frac{n\pi}{\int_a^b \sqrt{r(t)} dt} - \frac{1}{n\pi} \left( \frac{4(\nu-1)^2-1}{8 \int_a^b \sqrt{r(t)} dt} - \frac{1}{2} H(a) \right) + o\left(\frac{1}{n}\right) \quad (18)$$

where

$$H(a) = \int_a^{x_\nu} \left( \frac{q(x)}{\tilde{r}(x)} - \frac{1}{\tilde{r}^{3/4}} \frac{d^2}{dx^2} (\tilde{r}^{-1/4}) \right) \frac{\tilde{r}^{1/2}}{r^{1/2}} dx,$$

and

$$\tilde{r} = \left( \frac{d\xi}{dx} \right)^2 = \frac{4r(x)}{(1+2)^2 (\xi(x))^4}$$

(c) Let  $x_\nu$  be of type II. Then

$$\sqrt{\lambda_n} = \frac{n\pi}{\int_a^b \sqrt{r(t)} dt} - \frac{1}{n\pi} \left( \frac{4(\nu-1)^2-1}{8 \int_a^b \sqrt{r(t)} dt} + \left( \frac{4(\nu-1)^2-1}{8 \int_a^b \sqrt{r(t)} dt} - \frac{1}{2} H(a) - \frac{1}{2} H(b) \right) + o\left(\frac{1}{n}\right) \right) \quad (19)$$

where  $H(a)$  and  $H(b)$  are defined above. Case1:

$$\gamma = 0, \beta = \frac{\pi}{2}$$

(a) Let  $x_\nu$  be of type IV. Then

$$\sqrt{\lambda_n} = \frac{n\pi}{\int_a^b \sqrt{r(t)} dt} - \frac{1}{n\pi} \left( \frac{4(\nu-1)^2-1}{8 \int_a^b \sqrt{r(t)} dt} - \frac{1}{2} H(b) \right) + o\left(\frac{1}{n}\right) \quad (20)$$

where

$$H(b) = \int_{x_\nu}^b \left( \frac{q(x)}{\tilde{r}(x)} - \frac{1}{\tilde{r}^{3/4}} \frac{d^2}{dx^2} (\tilde{r}^{-1/4}) \right) \frac{\tilde{r}^{1/2}}{r^{1/2}} dx,$$

and

$$\tilde{r} = \left( \frac{d\xi}{dx} \right)^2 = \frac{4r(x)}{(1+2)^2 (\xi(x))^4}$$

(b) Let  $x_\nu$  be of type III. Then

$$\sqrt{\lambda_n} = \frac{n\pi}{\int_a^b \sqrt{r(t)} dt} - \frac{1}{n\pi} \left( \frac{4(\nu-1)^2-1}{8 \int_a^b \sqrt{r(t)} dt} - \frac{1}{2} H(a) \right) + o\left(\frac{1}{n}\right) \quad (21)$$

where

$$H(a) = \int_a^{x_\nu} \left( \frac{q(x)}{\tilde{r}(x)} - \frac{1}{\tilde{r}^{3/4}} \frac{d^2}{dx^2} (\tilde{r}^{-1/4}) \right) \frac{\tilde{r}^{1/2}}{r^{1/2}} dx,$$

and

$$\tilde{r} = \left( \frac{d\xi}{dx} \right)^2 = \frac{4r(x)}{(1+2)^2 (\xi(x))^4}$$

(c) Let  $x_\nu$  be of type II. Then

$$\sqrt{\lambda_n} = \frac{n\pi}{\int_a^b \sqrt{r(t)} dt} - \frac{1}{n\pi} \left( \frac{4(\nu-1)^2-1}{8 \int_a^b \sqrt{r(t)} dt} + \left( \frac{4(\nu-1)^2-1}{8 \int_a^b \sqrt{r(t)} dt} - \frac{1}{2} H(a) - \frac{1}{2} H(b) \right) + o\left(\frac{1}{n}\right) \right) \quad (22)$$

where  $H(a)$  and  $H(b)$  are defined above.

**Proof:** For proof see [8,9].

**2. The cases of two and n turning points**

From now then, without losing generalization, we suppose that the coefficients  $q(x)$  and  $r(x)$  satisfy:

(i)  $r(x)$  is real and has in  $[0, 1]$   $n$  zeros  $x_\nu$  of order  $l_\nu \in \mathbb{N}$ ,  $1 \leq \nu \leq n$  where  $0 < x_1 < x_2 < \dots < x_n < 1$ .

(ii) The function

$\Phi_0: I \rightarrow \mathbb{R} - \{0\}$ ,  $x \rightarrow r(x) \prod_{\nu=1}^n (x - x_\nu)^{-l_\nu}$  is twice continuously differentiable.

(iii)  $q(x)$  is bounded and integrable in  $I$ .

We shall use the symbol  $\Omega_{IV}(\xi, u)$  to signify the complex-valued solution of

$$W'' + u^2 \xi^{l_\nu} W = 0,$$

where  $\xi$  is corresponding Langer's transformation of turning point of type IV. We will use the symbols  $\Omega_I(\xi, u)$ ,  $\Omega_{II}(\xi, u)$  and  $\Omega_{III}(\xi, u)$  in similar case.

Now we can derive the following results on the distribution of the eigenvalues of (1) with Neumann boundary condition .

We consider only the following case:

$$r(0) < 0, r(1) < 0.$$

$$I.a \ T_1 = IV, T_2 = III.$$

We suppose that the weight function  $r(x)$  has in  $[0,1]$  two zeros  $x_1$  and  $x_2$  where  $x_1$  of type IV and  $x_2$  of type III . By (11) the distribution of positive eigenvalue satisfies :

$$\begin{aligned} n\pi \left( = \Im \int_0^1 \frac{y'}{y} dx \right) &= \Im \left( \int_0^{\alpha_{12}} \frac{y'}{y} dx + \int_{\alpha_{12}}^1 \frac{y'}{y} dx \right) \\ &+ \arctan\left(\frac{S(0, \lambda)}{T(0, \lambda)}\right) - \arctan\left(\frac{S(1, \lambda)}{T(1, \lambda)}\right) \\ &= \rho \int_0^1 \sqrt{r_+(t)} dt + \frac{\pi}{2} \\ &- \frac{1}{4\rho} \left( \frac{8v_1 - 4}{\int_{x_1}^{x_2} \sqrt{r(t)} dt} + \frac{8v_2 - 4}{\int_{x_2}^1 \sqrt{r(t)} dt} \right) \\ &+ \frac{1}{4\rho} \left( \frac{4v_1^2 - 1}{\int_{x_1}^{x_2} \sqrt{r(t)} dt} + \frac{4v_2^2 - 1}{\int_{x_2}^1 \sqrt{r(t)} dt} \right) \\ &- \frac{1}{2u} P(x_1, x_2) + O\left(\frac{1}{u^2}\right), \end{aligned} \tag{23}$$

where  $\alpha_{12} \in (x_1, x_2)$  is such that

$$\int_{x_1}^{\alpha_{12}} \sqrt{r(t)} dt = \int_{\alpha_{12}}^{x_2} \sqrt{r(t)} dt \text{ (the existence of } \alpha_{12} \text{ follows by Intermediate Value Theorem), and}$$

$$P(x_1, x_2) = P_{IV}(x_1, \alpha_{12}) + P_{III}(x_2, \alpha_{12}) = \int_{x_1}^{\alpha_{12}} E_{IV}(x) dx + \int_{\alpha_{12}}^{x_2} E_{III}(x) dx,$$

$$P_{IV}(x_1, \alpha_{12}) = \int_0^{\alpha_{12}} \frac{R_{IV}(\xi)}{\xi^{\frac{1}{2}}} d\xi = \int_{x_1}^{\alpha_{12}} \left( \frac{q(x)}{r(x)} - \frac{1}{r^{\frac{3}{2}} \frac{d^2}{dx^2}} (\tilde{r}^{-1/4}) \right) \frac{\tilde{r}^{\frac{1}{2}}}{r^{\frac{1}{2}}} dx = \int_{x_1}^{\alpha_{12}} E_{IV}(x) dx,$$

and

$$\tilde{r} = \left( \frac{d\xi}{dx} \right)^2 = \frac{r(x)}{(1+2^i \beta(x))}, \xi(\alpha_{12}) = d_{12}, \xi(x_1) = 0, \xi(0) = c_{12}$$

$$P_{III}(x_2, \alpha_{12}) = \int_{\alpha_{12}}^{x_2} \left( \frac{q(x)}{r(x)} - \frac{1}{r^{\frac{3}{2}} \frac{d^2}{dx^2}} (\tilde{r}^{-1/4}) \right) \frac{\tilde{r}^{\frac{1}{2}}}{r^{\frac{1}{2}}} dx = \int_{\alpha_{12}}^{x_2} E_{III}(x) dx.$$

By inversion, we get

$$\rho_n = \frac{n\pi - \frac{\pi}{2}}{\int_0^1 \sqrt{r_+(t)} dt} - \frac{1}{n\pi} \left\{ \frac{[4(v_1-1)^2-1] + [4(v_2-1)^2-1]}{4 \int_{x_1}^{x_2} \sqrt{r(t)} dt} - \frac{1}{2} P(x_1, x_2) \right\} + O\left(\frac{1}{n^2}\right) \tag{24}$$

**2.a**

$$T_1 = IV, T_2 = T_3 = \dots = T_{n-1} = III, T_n = III.$$

By applying the same method and using theorem (1),(2) we get :

$$\begin{aligned} n\pi &= \rho \int_0^1 \sqrt{r_+(t)} dt - \frac{(n-1)\pi}{2} + \frac{n\pi}{2} \\ &+ \frac{1}{4\rho} \left( \frac{4(v_1 - 1)^2 - 1}{\int_{x_1}^{x_2} \sqrt{r(t)} dt} + \frac{4(v_2 - 1)^2 - 1}{\int_{x_2}^1 \sqrt{r(t)} dt} \right) \\ &+ \frac{4(v_2 - 1)^2 - 1}{\int_{x_2}^{x_3} \sqrt{r(t)} dt} + \frac{4(v_3 - 1)^2 - 1}{\int_{x_3}^{x_4} \sqrt{r(t)} dt} \\ &+ \frac{4(v_3 - 1)^2 - 1}{\int_{x_4}^{x_5} \sqrt{r(t)} dt} + \dots + \frac{4(v_{n-1} - 1)^2 - 1}{\int_{x_{n-2}}^{x_{n-1}} \sqrt{r(t)} dt} \\ &+ \frac{4(v_{n-1} - 1)^2 - 1}{\int_{x_{n-1}}^{x_n} \sqrt{r(t)} dt} + \frac{4v_n^2 - 1}{\int_{x_n}^1 \sqrt{r(t)} dt} \end{aligned}$$

Where

$$- \frac{1}{2u} P(x_1, x_2, \dots, x_n) + O\left(\frac{1}{u^2}\right).$$

$$P(x_1, x_2, \dots, x_n) = \int_{x_1}^{\alpha_{12}} E_{IV}(x) dx + \sum_{i=1}^{n-2} \int_{\alpha_{i(i+1)}}^{x_{i+1}} E_{II}^-(x) + \sum_{i=1}^{n-2} \int_{x_{i+1}}^{\alpha_{i+1(i+2)}} E_{II}^+(x) + \int_{\alpha_{(n-1)n}}^1 E_{III}(x) dx$$

and by inversion :

$$\rho_n = \frac{n\pi - \frac{\pi}{2}}{\int_0^1 \sqrt{r_+(x)} dx} - \frac{1}{n\pi} \left[ \frac{[4(v_1 - 1)^2 - 1] + [4(v_2 - 1)^2 - 1]}{4 \int_{x_1}^{x_2} \sqrt{r(t)} dt} + \frac{[4(v_2 - 1)^2 - 1] + [4(v_3 - 1)^2 - 1]}{4 \int_{x_2}^{x_3} \sqrt{r(t)} dt} + \dots + \frac{[4(v_{n-1} - 1)^2 - 1] + [4(v_n - 1)^2 - 1]}{4 \int_{x_{n-1}}^{x_n} \sqrt{r(t)} dt} - \frac{1}{2} P(x_1, x_2, x_3, \dots, x_n) \right] + O\left(\frac{1}{n^2}\right).$$

**Remark.** Note that the reader can obtain asymptotic distribution of eigenvalues in different types of (TP) by consideration of combination of the above cases.

**Acknowledgements.** The authors would like to thank Tabriz Branch, Islamic Azad University for the financial support of this research, which is based on a research project contract.

**References**

1. M. Abramowitz and J.A. Stegun, Hand book of Mathematical Function , Appl, Math, Ser., no. 55, U.S, Govt. Printing office, Washington, D.C., 1964.
2. F.V. Atkinson and A. Mingarelli, Asymptotics of the number of zeros and the eigenvalues of general weighted Sturm-Liouville problems, Journal der reinen und angewandten Mathematik, 395(1986)380-93.
3. W. Eberhard, G. Freiling and A. Schneider, Connection formulae for second- order differential equations with a complex parameter

and having an arbitrary number of turning points, Math. Nachr, 85(1994)205-229.

4. W. Eberhard, G. Freiling and A. Schneider, On the distribution of the eigenvalues of a class of indefinite eigenvalues problems. J. Diff. and Integral Equ, 3(1990)1167-1179.
5. W. Eberhard and G. Freiling, The distribution of the eigenvalues for second-order eigenvalues problems in the presence of an arbitrary number of turning points, Results in Mathematics. Birkhäuser Verlag, 21(1992)24-24.
6. G. Freiling and V. Yorko, Inverse Sturm-liouville problems and their applications , Nova Science Publishers, Inc, 2001.
7. B.J. Harris and S.T. Talarico, On the eigenvalues of second-order linear differential equations with fractional transition points, Mathematical Proceedings of the Royal Irish Academy, 99A(1)(1999)29-38.
- A. Jodayree Akbarfam and A. Mingarelli, Higher-order asymptotic distribution of the eigenvalues of nondefinite Sturm -Liouville problems with one turning point, J. Com. App. Math, 149(2002)423-437.
- A. Jodayree Akbarfam and A. Mingarelli, Higher-order asymptotic of the eigenvalues of Sturm - Liouville problems with a turning point of arbitrary order, Cana. App. math. Quart, 12(2004)35-60.
8. R.E. Langer, The boundary problem associated with a Differential equation in which the coefficient of the parameter changes sign. Transact. Amer. Math. Soc, 31(1929)1-24.
- A. Leung, Distribution of eigenvalues in the presence of higher order turning points, Transact. Amer. Math. Soc, 229(1977)11-135.
9. A.B. Mingarelli, Asymptotic distribution of eigenvalues of non-definit Sturm-Liouville problems in Ordinary differential equations and operators, W.N.Everitt and R.T.Lewis(eds), Lecture Notes in Math. 1032, Springer-verlag, berlin, 1032(1983)375-383.
10. F. W. J. Olver, Asymptotics and Special Functions. Acad. Press, New York 1974.
11. S.T. Talarico, The asymptotic form of eigenvalues for indefinite Sturm-Liouville problems, Unpublished Ph.D. thesis, Northern Illinois University, 1995.

9/6/2012

**Solutions of Twelfth -Order Boundary Value Problems Using Polynomial Spline in Off Step Points**

Karim farajeyan<sup>1</sup> ; Nader Rafati Maleki<sup>2</sup>; Shahram Banaei<sup>3</sup>

<sup>1,3</sup>Department of Mathematics, Bonab Branch, Islamic Azad University ,Bonab ,Iran

<sup>2</sup>Department of Mathematics, Tabriz Branch, Islamic Azad University, Tabriz, Iran

[karim\\_faraj@yahoo.com](mailto:karim_faraj@yahoo.com); [n.rafatimaleki@yahoo.com](mailto:n.rafatimaleki@yahoo.com); [Sh\\_Banaei@yahoo.com](mailto:Sh_Banaei@yahoo.com)

**Abstract:** We use Polynomial spline functions in off step points to develop a numerical method for the solutions of twelfth order boundary value problems. We show that the present method gives an approximation which are better than those produced by other finite difference and spline methods. Two numerical examples are given to illustrate practical usefulness of our method.

[Karim farajeyan ; Nader Rafati Maleki ; Shahram Banaei. **Solutions of Twelfth -Order Boundary Value Problems Using Polynomial Spline in Off Step Points.** *Life Sci J* 2012;9(4):2980-2985]. (ISSN: 1097-8135). <http://www.lifesciencesite.com>. 438

**Keywords:** twelfth -order boundary-value problem; Polynomial spline functions; End conditions; Numerical results.

**1 Introduction**

We consider twelfth -order boundary-value problem of type

$$y^{(12)}(x) + f(x)y(x) = g(x) \quad , \quad x \in [a, b] \quad (1)$$

$$y(a) = \alpha_0, y^{(1)}(a) = \alpha_1, y^{(2)}(a) = \alpha_2, y^{(3)}(a) = \alpha_3, y^{(4)}(a) = \alpha_4, y^{(5)}(a) = \alpha_5, \\ y(b) = \beta_0, y^{(1)}(b) = \beta_1, y^{(2)}(b) = \beta_2, y^{(3)}(b) = \beta_3, y^{(4)}(b) = \beta_4, y^{(5)}(b) = \beta_5 \quad (2)$$

where  $\alpha_i, \beta_i$  for  $i = 0,1,2,3,4,5$  are finite real constants and the functions  $f(x)$  and  $g(x)$  are continuous on  $[a, b]$  .

Twizell et al.[1] developed numerical methods for 8th-,10th-,and 12th-order eigenvalue problems arising in thermal instability. Siddiqi and Twizell[2] presented the solutions of 12th order boundary value problems using the 12th degree spline, respectively. Siddiqi and Akram[3] developed the solution of 12th-order boundary value problems using non-polynomial spline. Siddiqi and Akram[4] presented the solution of 12th-order boundary value problem by using thirteen degree spline.

In this paper we used polynomial spline approximation in off step points to develop a family of new numerical methods to smooth approximations to the solution of 12th-order differential equation.The method developed is observed to be better than that developed by Siddiqi et al [3] , as discussed in Examples 1 and 2. In this paper, in Section 2, the new polynomial spline methods are developed for solving equation (1) along with boundary condition(2).The boundary formulas are develop in Section 3. In Section 4, the polynomial spline solution of the BVP (1),(2) is determined and in Section 5 numerical experiment,

discussion and comparison with other known methods, are give.

**2 Numerical methods**

Let  $S_i(x)$  be the polynomial spline defined on  $[a, b]$  as:

$$S_i(x) = a(x-x_i)^3 + b(x-x_i)^2 + c_i(x-x_i)^1 + d_i(x-x_i)^0 + e_i(x-x_i)^9 + f_i^*(x-x_i)^8 + \\ g_i^*(x-x_i)^7 + o_i(x-x_i)^6 + p_i(x-x_i)^5 + q_i(x-x_i)^4 + u_i(x-x_i)^3 + z_i^*(x-x_i)^2 + r_i(x-x_i) + u_i \quad (3)$$

$$x \in [x_{i-\frac{1}{2}}, x_{i+\frac{1}{2}}], i = 0,1,2,\dots,n-1 \text{ and } x_0 = a, x_n = b,$$

$$\text{Where } h = \frac{b-a}{n} \text{ and } x_{i-\frac{1}{2}} = a + (i - \frac{1}{2})h, i = 1,2,3,\dots,n$$

The spline  $S$  is defined in terms of its 1td, 2th, 3th, 4th, 5th and 12th derivatives and we denote these values at knots as:

$$S_i(x_{i-\frac{1}{2}}) = y_{i-\frac{1}{2}}, S_i'(x_{i-\frac{1}{2}}) = m_{i-\frac{1}{2}}, S_i''(x_{i-\frac{1}{2}}) = M_{i-\frac{1}{2}}, S_i'''(x_{i-\frac{1}{2}}) = z_{i-\frac{1}{2}}, S_i^{(4)}(x_{i-\frac{1}{2}}) = V_{i-\frac{1}{2}}$$

$$, S_i^{(5)}(x_{i-\frac{1}{2}}) = w_{i-\frac{1}{2}}, S_i^{(12)}(x_{i-\frac{1}{2}}) = L_{i-\frac{1}{2}},$$

$$S_i(x_{i+\frac{1}{2}}) = y_{i+\frac{1}{2}}, S_i'(x_{i+\frac{1}{2}}) = m_{i+\frac{1}{2}}, S_i''(x_{i+\frac{1}{2}}) = M_{i+\frac{1}{2}}, S_i'''(x_{i+\frac{1}{2}}) = z_{i+\frac{1}{2}}, S_i^{(4)}(x_{i+\frac{1}{2}}) = V_{i+\frac{1}{2}}$$

$$S_i^{(5)}(x_{i+\frac{1}{2}}) = w_{i+\frac{1}{2}}, S_i^{(12)}(x_{i+\frac{1}{2}}) = L_{i+\frac{1}{2}}$$

$$\text{For } i = 1,2,\dots,n. \quad (4)$$

Assuming  $y(x)$  to be the exact solution of the boundary value problem (1)

and  $y_i$  be an approximation to  $y(x_i)$ , obtained by the spline  $S_i(x)$ , we can obtained the coefficients in (3) in the following form

$$\begin{aligned}
a_i &= \frac{-1}{6227020800} (L_{i-\frac{1}{2}} - L_{i+\frac{1}{2}}), \quad b_i = \frac{1}{958003200} (L_{i-\frac{1}{2}} + L_{i+\frac{1}{2}}), \\
c_i &= \frac{1}{4151347200} [h^{12}(L_{i-\frac{1}{2}} - L_{i+\frac{1}{2}}) + 34594560(15120h(m_{i-\frac{1}{2}} + m_{i+\frac{1}{2}}) + 3360h^2(M_{i-\frac{1}{2}} - M_{i+\frac{1}{2}}) + \\
& 30h^4(V_{i-\frac{1}{2}} - V_{i+\frac{1}{2}}) + h^5(w_{i-\frac{1}{2}} + w_{i+\frac{1}{2}}) + 30240(y_{i-\frac{1}{2}} - y_{i+\frac{1}{2}}) + 420h^3(z_{i-\frac{1}{2}} + z_{i+\frac{1}{2}}))] , \\
d_i &= \frac{1}{638668800} [h^{11}(L_{i-\frac{1}{2}} + L_{i+\frac{1}{2}}) + 2661120(1680(m_{i-\frac{1}{2}} - m_{i+\frac{1}{2}}) + h(840(M_{i-\frac{1}{2}} + M_{i+\frac{1}{2}}) + \\
& h(20h(V_{i-\frac{1}{2}} + V_{i+\frac{1}{2}}) + h^2(w_{i-\frac{1}{2}} - w_{i+\frac{1}{2}}) + 180(z_{i-\frac{1}{2}} - z_{i+\frac{1}{2}})))] , \\
e_i &= \frac{1}{6642155520} [-h^{12}(L_{i-\frac{1}{2}} - L_{i+\frac{1}{2}}) - 69189120(18480h(m_{i-\frac{1}{2}} + m_{i+\frac{1}{2}}) + 4080h^2(M_{i-\frac{1}{2}} - M_{i+\frac{1}{2}}) + \\
& 30h^4(V_{i-\frac{1}{2}} - V_{i+\frac{1}{2}}) + h^5(w_{i-\frac{1}{2}} + w_{i+\frac{1}{2}}) + 36960(y_{i-\frac{1}{2}} - y_{i+\frac{1}{2}}) + 500h^3(z_{i-\frac{1}{2}} + z_{i+\frac{1}{2}}))] , \\
f_i &= \frac{1}{1021870080} [h^{11}(L_{i-\frac{1}{2}} + L_{i+\frac{1}{2}}) + 5322240(2160(m_{i-\frac{1}{2}} - m_{i+\frac{1}{2}}) + h(1080(M_{i-\frac{1}{2}} + M_{i+\frac{1}{2}}) + \\
& h(24h(V_{i-\frac{1}{2}} + V_{i+\frac{1}{2}}) + h^2(w_{i-\frac{1}{2}} - w_{i+\frac{1}{2}}) + 228(z_{i-\frac{1}{2}} - z_{i+\frac{1}{2}})))] , \\
g_i &= \frac{1}{1992646656} [h^{12}(L_{i-\frac{1}{2}} - L_{i+\frac{1}{2}}) + 103783680(23760h(m_{i-\frac{1}{2}} + m_{i+\frac{1}{2}}) + 5184h^2(M_{i-\frac{1}{2}} - M_{i+\frac{1}{2}}) + \\
& 38h^4(V_{i-\frac{1}{2}} - V_{i+\frac{1}{2}}) + h^5(w_{i-\frac{1}{2}} + w_{i+\frac{1}{2}}) + 47520(y_{i-\frac{1}{2}} - y_{i+\frac{1}{2}}) + 612h^3(z_{i-\frac{1}{2}} + z_{i+\frac{1}{2}}))] , \\
o_i &= \frac{-1}{3065610240} [h^{11}(L_{i-\frac{1}{2}} + L_{i+\frac{1}{2}}) + 7983360(3024(m_{i-\frac{1}{2}} - m_{i+\frac{1}{2}}) + h(1512(M_{i-\frac{1}{2}} + M_{i+\frac{1}{2}}) + \\
& h(28h(V_{i-\frac{1}{2}} + V_{i+\frac{1}{2}}) + h^2(w_{i-\frac{1}{2}} - w_{i+\frac{1}{2}}) + 308(z_{i-\frac{1}{2}} - z_{i+\frac{1}{2}})))] , \\
p_i &= \frac{1}{1062744880} [-h^{12}(L_{i-\frac{1}{2}} + L_{i+\frac{1}{2}}) + 138378240(33264h(m_{i-\frac{1}{2}} + m_{i+\frac{1}{2}}) + 7056h^2(M_{i-\frac{1}{2}} - M_{i+\frac{1}{2}}) + \\
& 42h^4(V_{i-\frac{1}{2}} - V_{i+\frac{1}{2}}) + h^5(w_{i-\frac{1}{2}} + w_{i+\frac{1}{2}}) + 66528(y_{i-\frac{1}{2}} - y_{i+\frac{1}{2}}) + 756h^3(z_{i-\frac{1}{2}} + z_{i+\frac{1}{2}}))] , \\
q_i &= \frac{1}{16349921280} [h^{11}(L_{i-\frac{1}{2}} + L_{i+\frac{1}{2}}) + 10644480(5040(m_{i-\frac{1}{2}} - m_{i+\frac{1}{2}}) + h(2520(M_{i-\frac{1}{2}} + M_{i+\frac{1}{2}}) + \\
& h(32h(V_{i-\frac{1}{2}} + V_{i+\frac{1}{2}}) + h^2(w_{i-\frac{1}{2}} - w_{i+\frac{1}{2}}) + 420(z_{i-\frac{1}{2}} - z_{i+\frac{1}{2}})))] , \\
u_i &= \frac{1}{1062744880} [h^{12}(L_{i-\frac{1}{2}} + L_{i+\frac{1}{2}}) + 17297280(55440h(m_{i-\frac{1}{2}} + m_{i+\frac{1}{2}}) + 10080h^2(M_{i-\frac{1}{2}} - M_{i+\frac{1}{2}}) + \\
& 46h^4(V_{i-\frac{1}{2}} - V_{i+\frac{1}{2}}) + h^5(w_{i-\frac{1}{2}} + w_{i+\frac{1}{2}}) + 110880(y_{i-\frac{1}{2}} - y_{i+\frac{1}{2}}) + 932h^3(z_{i-\frac{1}{2}} + z_{i+\frac{1}{2}}))] , \\
z_i &= \frac{-1}{163499212800} [h^{11}(L_{i-\frac{1}{2}} + L_{i+\frac{1}{2}}) + 13305600(15120(m_{i-\frac{1}{2}} - m_{i+\frac{1}{2}}) + h(4488(M_{i-\frac{1}{2}} + M_{i+\frac{1}{2}}) + \\
& h(36h(V_{i-\frac{1}{2}} + V_{i+\frac{1}{2}}) + h^2(w_{i-\frac{1}{2}} - w_{i+\frac{1}{2}}) + 546(z_{i-\frac{1}{2}} - z_{i+\frac{1}{2}})))] , \\
r_i &= \frac{1}{2550587710800} [-h^{12}(L_{i-\frac{1}{2}} + L_{i+\frac{1}{2}}) + 207567360(104880h(m_{i-\frac{1}{2}} + m_{i+\frac{1}{2}}) + 14640h^2(M_{i-\frac{1}{2}} - M_{i+\frac{1}{2}}) + \\
& 50h^4(V_{i-\frac{1}{2}} - V_{i+\frac{1}{2}}) + h^5(w_{i-\frac{1}{2}} + w_{i+\frac{1}{2}}) + 332640(y_{i-\frac{1}{2}} - y_{i+\frac{1}{2}}) + 1140h^3(z_{i-\frac{1}{2}} + z_{i+\frac{1}{2}}))] , \\
t_i &= \frac{1}{3923981107200} [h^{12}(L_{i-\frac{1}{2}} + L_{i+\frac{1}{2}}) + 15966720(46320(m_{i-\frac{1}{2}} - m_{i+\frac{1}{2}}) + 7800h^2(M_{i-\frac{1}{2}} + M_{i+\frac{1}{2}}) + \\
& 40h^4(V_{i-\frac{1}{2}} + V_{i+\frac{1}{2}}) + h^5(w_{i-\frac{1}{2}} - w_{i+\frac{1}{2}}) + 122880(y_{i-\frac{1}{2}} + y_{i+\frac{1}{2}}) + 740h^3(z_{i-\frac{1}{2}} - z_{i+\frac{1}{2}}))] ,
\end{aligned}$$

Assuming  $y(x)$  to be the exact solution of the boundary value problem (1) and  $y_i$  be an approximation to  $y(x_i)$  using the continuity conditions ( $S_{i-1}^{(\mu)}(x_i) = S_i^{(\mu)}(x_i)$  where  $\mu = 6,7,8,9,10$  and  $11$ ), we obtain the following spline relations:

$$\begin{aligned} & (y_{i-\frac{13}{2}} + y_{i+\frac{11}{2}}) - 12 (y_{i-\frac{11}{2}} + y_{i+\frac{9}{2}}) + 66 (y_{i-\frac{9}{2}} + y_{i+\frac{7}{2}}) - 220 (y_{i-\frac{7}{2}} + y_{i+\frac{5}{2}}) + 495 (y_{i-\frac{5}{2}} + y_{i+\frac{3}{2}}) - \\ & 792 (y_{i-\frac{3}{2}} + y_{i+\frac{1}{2}}) + 924 y_{i-\frac{1}{2}} = \frac{h^{12}}{6227020800} [(L_{i-\frac{13}{2}} + L_{i+\frac{11}{2}}) + 8178 (L_{i-\frac{11}{2}} + L_{i+\frac{9}{2}}) + \\ & 1479726 (L_{i-\frac{9}{2}} + L_{i+\frac{7}{2}}) + 4553345 (L_{i-\frac{7}{2}} + L_{i+\frac{5}{2}}) + 423281535 (L_{i-\frac{5}{2}} + L_{i+\frac{3}{2}}) + \\ & 1505621508 (L_{i-\frac{3}{2}} + L_{i+\frac{1}{2}}) + 2275172004 L_{i-\frac{1}{2}}], \quad i = 7, 8, \dots, n-7. \quad (5) \end{aligned}$$

**3 Development of the boundary formulas**

Liner system equation (5) consist of  $(n - 1)$  unknown, so that to obtain unique solution we need twelfth more equations to be associate with equation (5) so that we can develop the boundary formulas of different orders, but for sake of briefness here we develop the twelfth order boundary formulas so that we define the following identity:

$$w'_0 y_0 + \sum_{i=0}^7 a'_i y_{i+\frac{1}{2}} + c' h y'_0 + d' h^2 y''_0 + e' h^3 y'''_0 + u' h^4 y^{(4)}_0 + p' h^5 y^{(5)}_0 = h^{12} \sum_{i=0}^9 b'_i y^{(12)}_{i+\frac{1}{2}} \quad (6)$$

$$w''_0 y_0 + \sum_{i=0}^8 a''_i y_{i+\frac{1}{2}} + c'' h y'_0 + d'' h^2 y''_0 + e'' h^3 y'''_0 + u'' h^4 y^{(4)}_0 + p'' h^5 y^{(5)}_0 = h^{12} \sum_{i=0}^{10} b''_i y^{(12)}_{i+\frac{1}{2}} \quad (7)$$

$$w'''_0 y_0 + \sum_{i=0}^9 a'''_i y_{i+\frac{1}{2}} + c''' h y'_0 + d''' h^2 y''_0 + e''' h^3 y'''_0 + u''' h^4 y^{(4)}_0 + p''' h^5 y^{(5)}_0 = h^{12} \sum_{i=0}^{11} b'''_i y^{(12)}_{i+\frac{1}{2}} \quad (8)$$

$$w^{(4)}_0 y_0 + \sum_{i=0}^{10} a^{(4)}_i y_{i+\frac{1}{2}} + c^{(4)} h y'_0 + d^{(4)} h^2 y''_0 + e^{(4)} h^3 y'''_0 + u^{(4)} h^4 y^{(4)}_0 + p^{(4)} h^5 y^{(5)}_0 = h^{12} \sum_{i=0}^{12} b^{(4)}_i y^{(12)}_{i+\frac{1}{2}} \quad (9)$$

$$w^{(5)}_0 y_0 + \sum_{i=0}^{11} a^{(5)}_i y_{i+\frac{1}{2}} + c^{(5)} h y'_0 + d^{(5)} h^2 y''_0 + e^{(5)} h^3 y'''_0 + u^{(5)} h^4 y^{(4)}_0 + p^{(5)} h^5 y^{(5)}_0 = h^{12} \sum_{i=0}^{13} b^{(5)}_i y^{(12)}_{i+\frac{1}{2}} \quad (10)$$

$$\dot{w}_0 y_0 + \sum_{i=0}^{12} \dot{a}_i y_{i+\frac{1}{2}} + \dot{c} h y'_0 + \dot{d} h^2 y''_0 + \dot{e} h^3 y'''_0 + \dot{u} h^4 y^{(4)}_0 + \dot{p} h^5 y^{(5)}_0 = h^{12} \sum_{i=0}^{14} \dot{b}_i y^{(12)}_{i+\frac{1}{2}} \quad (11)$$

$$\ddot{w}_n y_n + \sum_{i=0}^{12} \ddot{a}_i y_{i+n-\frac{25}{2}} + \ddot{c} h y'_n + \ddot{d} h^2 y''_n + \ddot{e} h^3 y'''_n + \ddot{u} h^4 y^{(4)}_n + \ddot{p} h^5 y^{(5)}_n = h^{12} \sum_{i=0}^{14} \ddot{b}_i y^{(10)}_{i+n-\frac{29}{2}} \quad (12)$$

$$\ddot{\ddot{w}}_n y_n + \sum_{i=0}^{11} \ddot{\ddot{a}}_i y_{i+n-\frac{23}{2}} + \ddot{\ddot{c}} h y'_n + \ddot{\ddot{d}} h^2 y''_n + \ddot{\ddot{e}} h^3 y'''_n + \ddot{\ddot{u}} h^4 y^{(4)}_n + \ddot{\ddot{p}} h^5 y^{(5)}_n = h^{12} \sum_{j=0}^{13} \ddot{\ddot{b}}_j y^{(12)}_{i+n-\frac{27}{2}} \quad (13)$$

$$w^*_0 y_n + \sum_{i=0}^{10} a^*_i y_{i+n-\frac{21}{2}} + c^* h y'_n + d^* h^2 y''_n + e^* h^3 y'''_n + u^* h^4 y^{(4)}_n + p^* h^5 y^{(5)}_n = h^{12} \sum_{j=0}^{12} b^*_j y^{(12)}_{i+n-\frac{25}{2}} \quad (14)$$

$$\bar{w}_0 y_n + \sum_{i=0}^9 \bar{a}_i y_{i+n-\frac{19}{2}} + \bar{c} h y'_n + \bar{d} h^2 y''_n + \bar{e} h^3 y'''_n + \bar{u} h^4 y^{(4)}_n + \bar{p} h^5 y^{(5)}_n = h^{12} \sum_{i=0}^{11} \bar{b}_i y^{(12)}_{i+n-\frac{23}{2}} \quad (15)$$

$$\tilde{w}_0 y_n + \sum_{i=0}^8 \tilde{a}_i y_{i+n-\frac{17}{2}} + \tilde{c} h y'_n + \tilde{d} h^2 y''_n + \tilde{e} h^3 y'''_n + \tilde{u} h^4 y^{(4)}_n + \tilde{p} h^5 y^{(5)}_n = h^{12} \sum_{i=0}^{10} \tilde{b}_i y^{(12)}_{i+n-\frac{21}{2}} \quad (16)$$

$$\tilde{\tilde{w}}_0 y_n + \sum_{i=0}^7 \tilde{\tilde{a}}_i y_{i+n-\frac{15}{2}} + \tilde{\tilde{c}} h y'_n + \tilde{\tilde{d}} h^2 y''_n + \tilde{\tilde{e}} h^3 y'''_n + \tilde{\tilde{u}} h^4 y^{(4)}_n + \tilde{\tilde{p}} h^5 y^{(5)}_n = h^{12} \sum_{i=0}^9 \tilde{\tilde{b}}_i y^{(12)}_{i+n-\frac{19}{2}} \quad (17)$$





$$c_{\frac{1}{2}} = -w_0' y_0 - c' h y_0' - d' h^2 y_0'' - e' h^3 y_0''' - u' h^4 y_0^{(4)} - p' h^5 y_0^{(5)} + h^{12} \sum_{i=0}^9 b_i' g_{i+\frac{1}{2}},$$

$$c_{\frac{3}{2}} = -w_0'' y_0 - c'' h y_0' - d'' h^2 y_0'' - e'' h^3 y_0''' - u'' h^4 y_0^{(4)} - p'' h^5 y_0^{(5)} + h^{12} \sum_{i=0}^{10} b_i'' g_{i+\frac{1}{2}},$$

$$c_{\frac{5}{2}} = -w_0''' y_0 - c''' h y_0' - d''' h^2 y_0'' - e''' h^3 y_0''' - u''' h^4 y_0^{(4)} - p''' h^5 y_0^{(5)} + h^{12} \sum_{i=0}^{11} b_i''' g_{i+\frac{1}{2}},$$

$$c_{\frac{7}{2}} = -w_0^{(4)} y_0 - c^{(4)} h y_0' - d^{(4)} h^2 y_0'' - e^{(4)} h^3 y_0''' - u^{(4)} h^4 y_0^{(4)} - p^{(4)} h^5 y_0^{(5)} + h^{12} \sum_{i=0}^{12} b_i^{(4)} g_{i+\frac{1}{2}},$$

$$c_{\frac{9}{2}} = -w_0^{(5)} y_0 - c^{(5)} h y_0' - d^{(5)} h^2 y_0'' - e^{(5)} h^3 y_0''' - u^{(5)} h^4 y_0^{(4)} - p^{(5)} h^5 y_0^{(5)} + h^{12} \sum_{i=0}^{13} b_i^{(5)} g_{i+\frac{1}{2}},$$

$$c_{\frac{11}{2}} = -\dot{w}_0 y_0 - \dot{c} h y_0' - \dot{d} h^2 y_0'' - \dot{e} h^3 y_0''' - \dot{u} h^4 y_0^{(4)} - \dot{p} h^5 y_0^{(5)} + h^{12} \sum_{i=0}^{14} \dot{b}_i g_{i+\frac{1}{2}},$$

$$c_{i-\frac{1}{2}} = h^{12} (\alpha g_{i-\frac{13}{2}} + \beta g_{i-\frac{11}{2}} + \gamma g_{i-\frac{9}{2}} + \delta g_{i-\frac{7}{2}} + \eta g_{i-\frac{5}{2}} + \mu g_{i-\frac{3}{2}} + \tau g_{i-\frac{1}{2}} + \mu g_{i+\frac{1}{2}} + \eta g_{i+\frac{3}{2}} + \delta g_{i+\frac{5}{2}} + \gamma g_{i+\frac{7}{2}} + \beta g_{i+\frac{9}{2}} + \alpha g_{i+\frac{11}{2}}), \quad i = 7, 8, \dots, (n-7)$$

$$c_{n-\frac{11}{2}} = -\ddot{w}_0 y_n - \ddot{c} h y_n' - \ddot{d} h^2 y_n'' - \ddot{e} h^3 y_n''' - \ddot{u} h^4 y_n^{(4)} - \ddot{p} h^5 y_n^{(5)} + h^{12} \sum_{i=0}^{14} \ddot{b}_i g_{i+n-\frac{29}{2}},$$

$$c_{n-\frac{9}{2}} = -\ddot{w}_0 y_n - \ddot{c} h y_n' - \ddot{d} h^2 y_n'' - \ddot{e} h^3 y_n''' - \ddot{u} h^4 y_n^{(4)} - \ddot{p} h^5 y_n^{(5)} + h^{12} \sum_{i=0}^{13} \ddot{b}_i g_{i+n-\frac{27}{2}},$$

$$c_{n-\frac{7}{2}} = -w_0^* y_n - c^* h^2 y_n' - d^* h^2 y_n'' - e^* h^3 y_n''' - u^* h^4 y_n^{(4)} - p^* h^5 y_n^{(5)} + h^{12} \sum_{i=0}^{12} b_i^* g_{i+n-\frac{25}{2}},$$

$$c_{n-\frac{5}{2}} = -\bar{w}_0 y_n - \bar{c} h y_n' - \bar{d} h^2 y_n'' - \bar{e} h^3 y_n''' - \bar{u} h^4 y_n^{(4)} - \bar{p} h^5 y_n^{(4)} + h^{12} \sum_{i=0}^{11} \bar{b}_i g_{i+n-\frac{23}{2}},$$

$$c_{n-\frac{3}{2}} = -\tilde{w}_0 y_n - \tilde{c} h y_n' - \tilde{d} h^2 y_n'' - \tilde{e} h^3 y_n''' - \tilde{u} h^4 y_n^{(4)} - \tilde{p} h^5 y_n^{(5)} + h^{12} \sum_{i=0}^{10} \tilde{b}_i g_{i+n-\frac{21}{2}},$$

$$c_{n-\frac{1}{2}} = -\tilde{w}_0 y_n - \tilde{c} h y_n' - \tilde{d} h^2 y_n'' - \tilde{e} h^3 y_n''' - \tilde{u} h^4 y_n^{(4)} - \tilde{p} h^5 y_n^{(5)} + h^{12} \sum_{i=0}^9 \tilde{b}_i g_{i+n-\frac{19}{2}},$$

**5 Numerical results**

**Example 1.** We Consider the following boundary-value problem

$$y^{(12)}(x) + xy(x) = -(120 + 23x + x^3)e^x, \quad 0 \leq x \leq 1,$$

$$y(0) = 0, y(1) = 0,$$

$$y'(0) = 1, y'(1) = -e,$$

$$y''(0) = 0, y''(1) = -4e,$$

$$y'''(0) = -3, y'''(1) = -9e,$$

$$y^{(4)}(0) = -8, y^{(4)}(1) = -16e.$$

$$y^{(5)}(0) = -15, y^{(5)}(1) = -25e. \quad (15)$$

The analytic solution of the above system is  $y(x) = x(1-x)e^x$ . It is evident from Table 1 that the maximum errors in absolute values are less than those presented by [3].

**Example 2.** We Consider the following boundary-value problem

$$y^{(12)}(x) - y(x) = -12(2x \cos x + 1 \sin x), \quad -1 \leq x \leq 1,$$

$$y(-1) = y(1) = 0,$$

$$y'(-1) = y'(1) = 2 \sin(1),$$

$$\begin{aligned}
 y''(-1) &= -y''(1) = -4 \cos(1) - 2 \sin(1) , \\
 y'''(-1) &= y'''(1) = 6 \cos(1) - 6 \sin(1) , \\
 y^{(4)}(-1) &= -y^{(4)}(1) = 8 \cos(1) + 12 \sin(1) , \\
 y^{(5)}(-1) &= y^{(5)}(1) = -20 \cos(1) + 10 \sin(1) .
 \end{aligned}
 \tag{16}$$

The analytic solution of the above system is  $y(x) = (x^2 - 1)\text{Sin}x$ . It is evident from Table 2 that the maximum errors in absolute values are less than those presented by [3].

**Conclusion**

We approximate solution of the twelfth-order linear boundary-value problems by using polynomial spline. The new methods enable us to approximate the solution at every point of the range of integration. The method is compared with that developed by et al [3] considering the same examples. Tables 1-2 shows that our methods produced better result the sense that  $\max|e_i| = \max|y(x_i) - y_i|$  is in comparison with the method in [3].

Table 1: Observed maximum absolute errors for example 1.

h	Our methods	[3]
1/9	3.84(-12)	7.38(-9)
1/18	8.98(-13)	-
1/27	2.04(-13)	-
1/36	7.58(-14)	-

Table 2: Observed maximum absolute errors for example 2.

h	Our methods	[3]
1/16	9.15(-10)	1.14(-7)
1/32	1.33(-10)	-
1/48	6.31(-11)	-
1/64	2.19(-11)	-

**References**

1. Twizell, E .Boutayeb,A .Djidjeli, K., "Numerical methods for eighth, tenth and twelfth-order eigenvalue problems arising in thermal instability", *Advances in Computational Mathematics*, Vol.2,pp. 407–436, 1994.
2. Siddiqi, S.S, Twizell, E.H., "Spline solution of linear twelfth-order boundary value problems", *Int. J.Comput.Appl.Math*.Vol.78,PP.371-390, 1997.
3. Siddiqi, S.S, Akram,G., "Solution of 12th-order boundary value problems using non-polynomial spline technique ", *Applied Mathematics and Computation*, Vol.199,pp. 559–571, 2008.
4. Siddiqi, S.S, Akram,G., "Solution of tenth-order boundary value problems using eleventh degree spline", *Applied Mathematics and Computation*, Vol.182,pp. 1443–1453, 2006.
5. J. Rashidinia, R. Jalilian, K. Farajeyan. Spline approximate solution of eighth-order boundary-value problems. *International Journal of Computer Mathematics*, 2009, 86: 1319–1333.

## Estimation of chemical resistance of PFM dental ceramics by neural network

Siamak haghypour, Sayana rostami

Department of biomedical engineering, Tabriz Branch, Islamic Azad University, Tabriz, Iran  
haghypour@iaut.ac.ir

**Abstract:** artificial neural networks are one of the intelligent systems that apply experimental data in order to obtain the hidden rule among data and model the system. Despite the high ability of neural networks, this method has limited application in biomaterial engineering so that it has not been used for estimating the chemical resistance of dental ceramics. The purpose of this research is to determine the mass concentration of ions eluted from dental ceramics emerged in an acid and draw on the results to develop a feed forward back propagation neural network to simulated the mechanism of elution of this type of ceramics. By designing such an intelligent system, it is possible to investigate and determine the eluted ions from each type of dental porcelains in a long period of time and anytime without the necessity of doing long experiments and high cost. Furthermore, this system is able to change the composition of each porcelain as software in a simulated media and compute the changes of ion's elution and consequently draw on the best possible combination for a particular powder. Because of high correction coefficient and low normalized root mean square error (NRMSE) between the measured data and the estimate data, it is concluded that the artificial neural network has a great potential in investigating the model of the system and it is high ability in modeling the mechanism of the elution in dental ceramics

[Siamak haghypour, Sayana rostami. **Estimation of chemical resistance of PFM dental ceramics by neural network.** *Life Sci J* 2012;9(4):2986-2996]. (ISSN: 1097-8135). <http://www.lifesciencesite.com>. 439

**Keywords:** Neural networks, chemical resistance, porcelain, ICP, PFM.

### 1. INTRODUCTION

Dental materials have to satisfy strict criteria because of their long therapeutic durability in the oral cavity. One of the most important properties of all restorative dental materials is their chemical resistance. Chemical resistance or chemical durability depends on the structure and the composition of the powder materials, laboratory conditions and type of restoration [1]. Also non-durability of porcelain can result in more important release of ions from the surface and then it causes porosity. The resulting porosities not only decrease the crack growing resistance, but also allow bacteria and oral liquids penetrate and this can result in plaque. The increase of elution from the surface of porcelain causes undesired consequences in body. ISO and ADA standards are usually used for testing the chemical resistance of restorative materials [2, 3] using acid solutions. The goal of these methods is to find out the amount of eluted ions after an exposure in different periods from several hours to several days. In order to study the chemical durability of dental materials, it is necessary to expose them to an acid solvent for a long period and register the amount of eluted ions in different time intervals.

Any reports have found in the literature about long period-ion release from dental ceramic restorations. But this method requires a lot of time and cost. There has not been any report introducing techniques for determination of chemical release amount during a

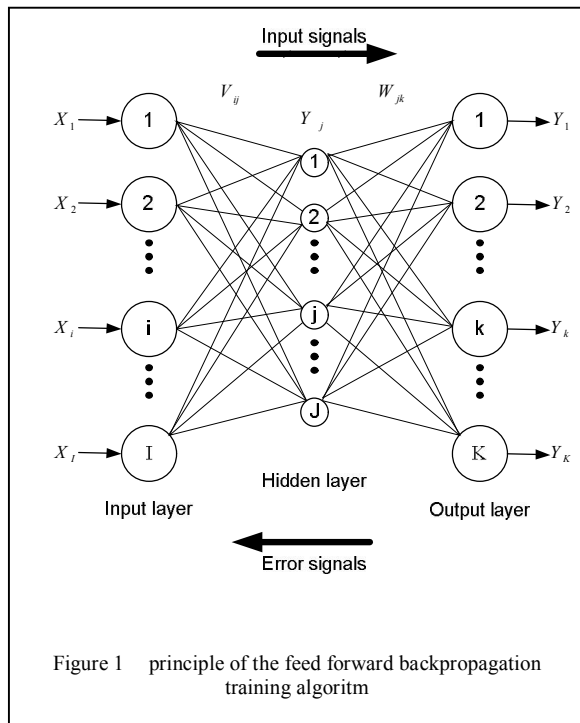
long period testing. The aim of this study was to design an intelligent system to compute the amount of released ions from feldspathic porcelain materials.

### 2. ARTIFICIAL NEURAL NETWORK

Artificial neural networks (ANN) are inspired by the biological neural system and its ability to learn through example. Instead of following a group of well-defined rules specified by the user, neural networks learn through intrinsic rules obtained from presented samples. The most commonly used ANN architecture is the multilayer back propagation neural network. Back propagation was created by generalizing the Widrow- Hoff learning rule to multiple-layer networks and nonlinear differentiable transfer functions [15]. Input vectors and the corresponding target vectors are used to train the network until it can approximate a function, associate input vectors with specific output vectors. Standard back propagation is a gradient descent algorithm, as is the Widrow-Hoff learning rule, in which the network weights are moved along the negative of the gradient of the performance function. The term back propagation refers to the manner in which the gradient is computed for nonlinear multilayer networks. Back propagation neural networks often have one or more hidden layers of sigmoid neurons followed by an output layer of linear neurons. Multiple layers of neurons with nonlinear transfer functions allow the network to learn nonlinear and

linear relationships between input and output vectors. There are numerous variations of the basic algorithm that are based on other standard optimization techniques, such as conjugate gradient and Newton methods [15]. The one used in this paper is the feed forward Back propagation training algorithm designed to minimize the Normalized root mean square error (NRMSE) between the actual (estimation) output and the desired (target) output. Fig. 1 shows the principle of the feed forward back propagation training algorithm. The basic learning algorithm can be summarized as follows:

- Step 1: Set the initial values of weights
- Step 2: Compute the outputs of all neurons layer-by-layer
- Step 3: Compute system error
- Step 4: If error is small enough or learning iteration is too big, stop learning



- Step 5: Compute learning errors for every neuron layer-by-layer
- Step 6: Update weights along negative gradient of error
- Step 7: Repeat from Step 2

### 3. EXPERIMENTAL PROCEDURES

According to the aforementioned, preparing some experimental samples from PFM prosthesis is needed in which the obtained data for training the network will be used. The obtained data from each sample include two parts. The first part was the weight

percentage of porcelain composition used as the network inputs. The second part of data was related to the amount of eluted ions from the surface of porcelain used as outputs of the network. So, experimental procedure in this study was included in three major steps:

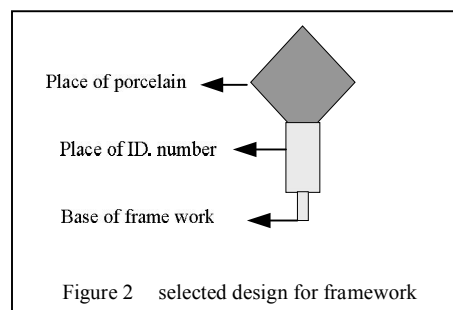
- Sample preparation
- Determining the composition of each porcelain
- Determining the percentage of eluted ions in the specific time intervals

#### a. Sample preparation

Six types of vastly used commercial porcelain powders were employed to make the samples as the following:

*Noritake, Alldent, CeramcoIII, Ivoclar, Vita, CeramcoII.*

It should be noted that these powders contained different compositions that was needed in this research. The first step in making the samples is preparing the frame work. For making the frame work, referred to ASTM book to find out standards. After investigation, no standards were found. At first, different samples were designed as frame works but finally the Fig. 2 was selected as a suitable design. The reason for this selection was making similar conditions for all samples i.e. the width, dimension of the samples and firing condition in the furnace should be the same. In this method of designing, samples with 1\*1 cm dimension were made then a small plate was considered in order to put label over the samples. At the bottom of the metal plate, a metal bar was devised to be placed in the hollow of the crucible and they underwent the same heat in all directions. Besides another characteristic of this scheme is the possibility changing and correcting the width and its dimension in order to optimize the favorite size. After designing the frame work the mold was prepared. For this purpose a mold of plaster of high stone gypsum was prepared from the expected design. A plaster mold is smeared with a microfilm insulator and filled with inlay wax.



Then the wax is taken out from the mold. Waxen samples are placed at the bottom of the cylinder and the surface of the samples is smeared with vaco film. After the vaco film was dried, the cylinder moved to the bottom. For removing moisture a filter paper was placed on the inner side of cylinder. Next, casting plaster was blended with the liquid inside the vacuum mixer to send the air bubbles out completely. The plaster inside the cylinder was poured over the vibrator and after the plaster dilated, the cylinder was exposed to 40 degree centigrade warm water to start hygroscopic expansion. After the casting plaster was set (approximately after 24 hours), the cylinder was placed inside the burn out furnace. (Temperature of this furnace is 900 to 950 degree centigrade), after 15 to 20 minutes the liquid wax was evaporated and become ready for casting. For casting at first the alloy (super cast alloy manufactured in thermo bond alloy MFG) was melted inside the crucible and after melting, the cylinder was placed at the bottom of crucible. The centrifuge which had been tuned in advance was released to force the molten alloy to go to the cylinder vents. The cylinder is let get colder in the ambient temperature. 24 hours later the cylinder is depleted of the cast. The metal samples are segregated by sand blast machine with aluminum oxide and air pressure from the plaster completely. Then the samples are placed in ultrasonic set with choleric acid and extra plaster is separated from the surface of the alloy because of slight vibration sound waves. After that the thickness of samples are equalized by the stone molt and becomes 0.3 mm. Then the samples are boiled by distilled water for 5 minutes to remove all impurities from their surface. Then the samples are put in the furnace to be degassed. Then a diluted layer of opaque is put over the metal samples. After firing the pre layer of opaque, the main layer of opaque is placed over it. In each sample, the porcelain powder is diluted with its liquid and is placed on the opaque. In order to compact the powders, the samples are vibrated and their moisture is removed. To obtain and correct the favorite shape, dimension and width, the porcelain powders were placed for the second time and were exposed to thermal procedure. Glaze liquid without glaze powder was used for glazing the samples and then was put over the dentin surface by paint brush. Since using the enamel powder makes the samples homogeneity and also the operated experiment

unreliable, enamel was not used in making samples. To maintain and retain the samples, half-liter flasks were applied. Applying distilled water, 0.3 molar hydrochloric acid was prepared and poured into flasks. The flasks in the oven were exposed to the temperature of 50 degree centigrade and every day, 50cc of the solution inside the flasks was taken and the mass concentration of eluted ions was measured. In order to examine the accuracy of the results, after taking each sample its pH was measured.

*b. determining the combination of each porcelain*

In order to determine the percentage of the amount of composition in each porcelain, ICP and Atomic Absorption Spectrophotometer were applied. This method was operated by solving each powder into different acids (hydrofluoric acid, per chloric acid, nitric acid and hydrochloric acid) and giving that to the apparatus. Table 1

The main parts of porcelain are made of this composition. The rest consist of pigment,  $B_2O_3$ , and some other elements. Because of their less effect in the amount of elution, they were ignored

*c. Determination of the amount of eluted ions from the surface of porcelain in particular intervals time*

After resting the samples into the 0.3 molar hydrochloric acid, the amount of 50cc was taken every 10 days and the percentage of ions  $Si^{+4}$ ,  $Na^+$ ,  $K^+$ ,  $Ca^{+2}$  and  $Al^{+3}$  were determined. Since the amount of eluted ions from the surface of porcelain was about ppb, for determining and estimating their amount, ICP (varian-735OES) with ultrasonic nebulizer was used. The reason for using this nebulizer was its high ability and power in atomizing the present elements in the solution. The obtained data from lab records, after process was computed based on the amount of eluted ions from each gram of porcelain sample. This data are shown in Table 2. Also in order to get more accurate comparison and investigation, the amount of eluted ions from the surface of each porcelain sample has been illustrated in Fig. 3. In addition to recorded results and for more accurate estimation, the values of pH for each sample were measured and recorded in a period of three mounts. These values have been illustrated in Fig. 4

TABLE I. WEIGHT PERCENTAGE OF EACH PORCELAIN COMBINATIONS

Mean of composition %	Porcelains type					
	<i>nor take</i>	<i>All dent</i>	<i>Ceramic III</i>	<i>Viola</i>	<i>vita</i>	<i>Ceramic II</i>
Al <sub>2</sub> O <sub>3</sub>	14.16	14.96	14.31	13.43	14.76	13.48
Boa	0.02	0.74	0.22	0.76	1.27	0.02
ClO	0.40	0.89	0.44	0.94	0.67	0.60
CeO <sub>2</sub>	0.00	0.38	0.19	0.36	0.00	0.02
k <sub>2</sub> O	12.26	13.08	12.98	12.94	12.40	12.85
LiO <sub>2</sub>	0.19	0.09	0.33	0.00	0.85	0.48
Mao	0.30	0.02	0.09	0.01	0.23	0.41
Na <sub>2</sub> O	4.02	3.08	2.55	3.11	2.92	3.04
SiO <sub>2</sub>	65.62	58.25	62.59	58.73	59.48	63.21
TiO <sub>2</sub>	0.01	0.13	0.03	0.11	0.20	0.00

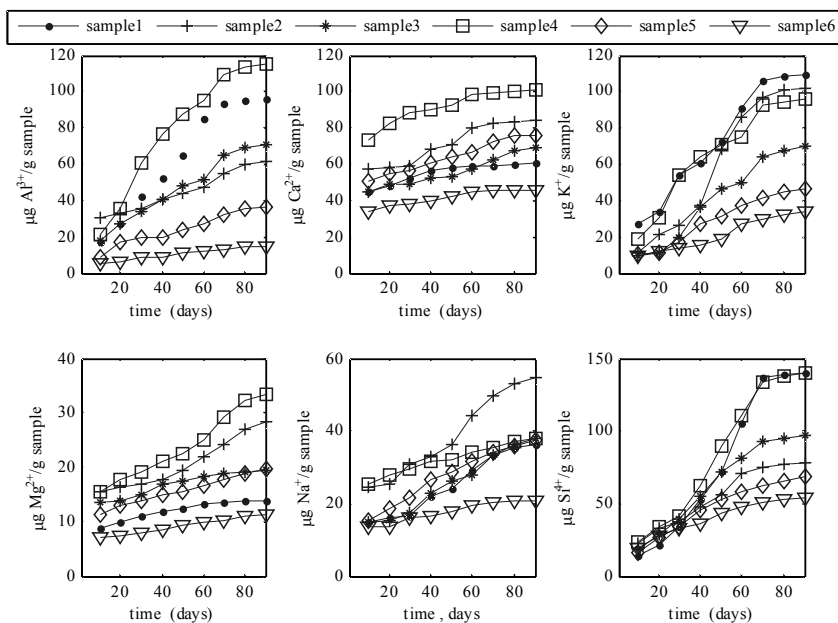


Figure 3 comparison of the amount of eluted ions from the surface of all samples

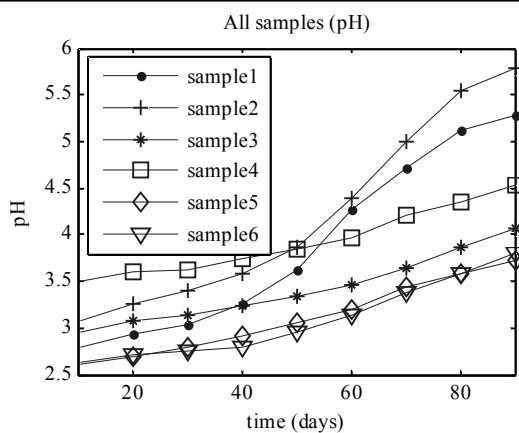


Figure 4 recorded values of pH for each sample

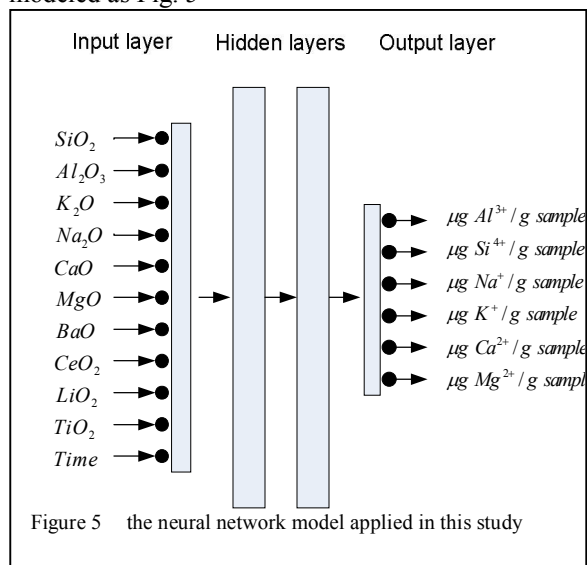
TABLE II. THE AMOUNT OF ELUTED IONS FROM EACH GRAM OF SAMPLES

INPUT DATA			OUTPUT DATA						
Sump.	Mean of composition %		Time (day)	Mass of eluted ion per gram of samples					
	$Al_2O_3$ $BaO$ $CaO$ $CeO_2$ $K_2O$	$LiO_2$ $MgO$ $Na_2O$ $SiO_2$ $TiO_2$		$\mu g Mg^{2+} / g$ sample	$\mu g Ca^{2+} / g$ sample	$\mu g K^+ / g$ sample	$\mu g Na^+ / g$ sample	$\mu g Si^{4+} / g$ sample	$\mu g Al^{3+} / g$ sample
1	14.16	0.19	10	8.76	44.57	27.33	14.94	13.8	17.06
			20	9.84	48.14	34.24	16.02	21.8	26.95
	0.02	0.30	30	10.92	52.4	54.06	16.76	33.87	41.98
			40	11.87	56.9	60.79	22.08	53.03	52.47
	0.40	4.02	50	12.55	58.66	72.5	24.01	71.6	64.93
			60	13.18	59.01	91.35	28.98	105.09	85.03
	0.00	65.62	70	13.67	59.56	106.27	33.4	136.79	93.82
			80	13.86	60.24	108.31	35.46	139.48	95.58
	12.26	0.01	90	13.89	60.66	109.39	36.45	140.32	96.5
2	14.96	0.09	10	15.55	57.18	11.23	24.63	22.97	30.82
			20	16.33	58.34	21.07	25.44	32.73	33.5
	0.74	0.02	30	16.79	59.36	26.81	30.7	37.76	35.81
			40	17.77	68.46	37.25	33.13	47.38	40.75
	0.89	3.08	50	19.46	71.1	68.43	36.17	55.62	43.98
			60	21.84	80.31	85.74	44.44	70.74	47.2
	0.38	58.25	70	24.32	82.42	96.84	49.64	74.76	55.35
			80	26.92	83.91	101.05	52.91	76.8	59.92
	13.08	0.13	90	28.32	84.48	102.01	54.77	77.73	61.61
3	14.31	0.33	10	13.52	44.96	10	15.07	18.15	17.85
			20	13.93	49.14	11.53	15.25	28.35	27.27
	0.22	0.09	30	14.92	49.45	19.63	17.49	39.63	33.65
			40	16.83	52.05	36.32	22.76	55.47	40.52
	0.44	2.55	50	17.58	53.06	46.32	26.32	71.55	48.17
			60	18.31	57.58	49.52	28.05	81.28	51.5
	0.19	62.59	70	18.83	62.44	63.89	33.51	92.68	64.97
			80	19.29	67.75	67.81	36.29	95.19	69.45
	12.98	0.03	90	19.41	69.06	70.23	37.78	97.28	71.16
4	13.43	0.00	10	15.53	73.62	18.68	25.44	23.42	21.58
			20	17.74	82.56	30.83	27.95	33.72	35.38
	0.76	0.01	30	19.03	88.46	54.27	29.38	41.76	60.72
			40	21.09	90.08	64.42	31.63	62.07	76.72
	0.94	3.11	50	22.47	92.7	71.02	32.24	89.38	87.34
			60	25.04	98.53	75.1	34.21	110.66	95.02
	0.36	58.73	70	29.13	99.26	92.99	35.58	133.59	109.27
			80	32.42	100.56	94.58	37.26	138.44	113.82
	12.94	0.11	90	33.46	101.43	96.11	37.8	140.13	115.22
5	14.76	0.85	10	11.27	50.71	10.1	15.31	15.88	9.11
			20	13.05	54.95	11.54	18.54	27.22	17.54
	1.27	0.23	30	13.9	56.6	17.08	21.6	34.1	19.65
			40	14.88	60.82	27.01	26.64	45.77	20.1
	0.67	2.92	50	15.44	63.88	31.76	28.83	53.19	23.55
			60	16.54	66.4	37.45	31.7	57.87	27.11
	0.00	59.48	70	17.88	72.92	41.31	34.28	62.78	32.4
			80	18.91	75.67	45.18	36.05	66.08	35.61
	12.40	0.20	90	19.75	76.29	46.44	37.59	68.48	36.14
6	13.48	0.48	10	7.16	33.77	10	13.49	19.91	5.16
			20	7.35	37.31	12.43	13.61	27.47	6.68
	0.02	0.41	30	7.88	38.3	13.95	16.28	33.03	8.77
			40	8.5	39.75	15.74	16.63	36.61	9.18
	0.60	3.04	50	9.27	42.49	18.53	18.04	43.32	11.49
			60	9.82	45	27.56	19.47	48.08	12.51
	0.02	63.21	70	10.17	45.46	30.11	20.19	50.65	13.34
			80	10.99	45.89	32.4	20.57	52.7	14.3
	12.85	0.00	90	11.27	46.11	33.58	20.8	53.8	14.64



#### 4. SIMULATION BY NEURAL NETWORKS

The process consists of testing with a 4-layer network (11-12-12-6) of feed forward back propagation. The input layer was structured based on data related to the chemical combination of dental ceramics ( $\text{Al}_2\text{O}_3$ ,  $\text{SiO}_2$ ,  $\text{K}_2\text{O}$ ,  $\text{LiO}_2$ ,  $\text{CeO}_2$ ,  $\text{BaO}$ ,  $\text{MgO}$ ,  $\text{CaO}$ ,  $\text{Na}_2\text{O}$ ,  $\text{TiO}_2$ ) and the exposure time of samples to acid and output layer based on data related to the mass concentration of eluted ions from the surface of ceramic ( $\text{Si}^{+4}$ ,  $\text{Na}^+$ ,  $\text{K}^+$ ,  $\text{Ca}^{+2}$ ,  $\text{Mg}^{+2}$ ,  $\text{Al}^{+3}$ ). The selected model with 11 neurons in input layer, 12 neurons in the first hidden layer, 12 neurons in the second hidden layer and 6 neurons in the output layer was obtained according to try and error. For modeling, matlab software and neural network tool box were used and according to its commands, the hidden layers of the network were determined. As a transfer function, sigmoid transfer function for both hidden layers and linear transfer function for output layer were selected. For network training, back propagation algorithm was applied [7]. The resulted data in 10, 20, 30, 40, 60, 70, 80 and 90 days of experiment in the process of network training and resulted data in the fifth period of the experiment were taken out of the process of training and used for network testing. With the help of obtained experimental data, the neural network for estimating the chemical resistance of dental ceramics was modeled as Fig. 5



In order to examine the efficiency of learning algorithm a criteria named performance index is used. This can do comparison between the application of neural network algorithm and other

learning algorithms. The performance index used in this process is normalized root mean square error.

#### 5. RESULTS

Fig. 6 and Fig. 7 show the comparison between measured data (ME) and estimated data by the neural network (NN). In all six ceramic samples, the value of out put for each mentioned ions, both from the obtained results for experiments and neural networks are depicted. The designed system is an intelligent system and has the ability of accurate prediction from the release process of ions from the surface of dental ceramics. In order to present the capabilities of his system, study two examples of its applications.

##### A. The ability of predicting the amount of the elution of each ion in periods more than 3 month

The experimental records done in this study are related to a period of three months but the designed system has the ability of receiving the information related to components of each porcelain and then estimating the amount of eluted ions from its surface in a long period of time. For this purpose, the sample 2 was used for this test. In this sample, the data related to release in the fourth month was recorded so it was possible to compare the network out put with experimental records and determine the accuracy of the network. Then the information data to this sample was presented as the percentage of the components in chemical composition of powder and the out put was examined as diagram of release up to fourth month. The results about experimental data and the network out puts have been showed up to 120 days in Fig. 8. In the diagrams related to the release of aluminum, magnesium and sodium as it was obtained from experimental recordings, it was expected that after third month the slope of diagrams fell down and the rate of release become approximately constant. Considering Fig. 8 the out puts of the network were according to this situation. In the diagram of calcium elution, after third month the gradient was upward and the rate of release wasn't stable. Regarding that this situation is according to experimental recordings in the fourth month, then the prediction was correct and in this sample, calcium elution rose up to fourth month. In the diagram resulting from silica elution, against the measured data in the fourth month, the out put of network had a slight increase but the slope of diagram in this range was some who could be accepted the estimated data by the neural network with the reasonable error. In the diagram of potassium elution, the diagram in fourth month undergoes a sudden hefty fall which is contrary to fact and experiences the network error.

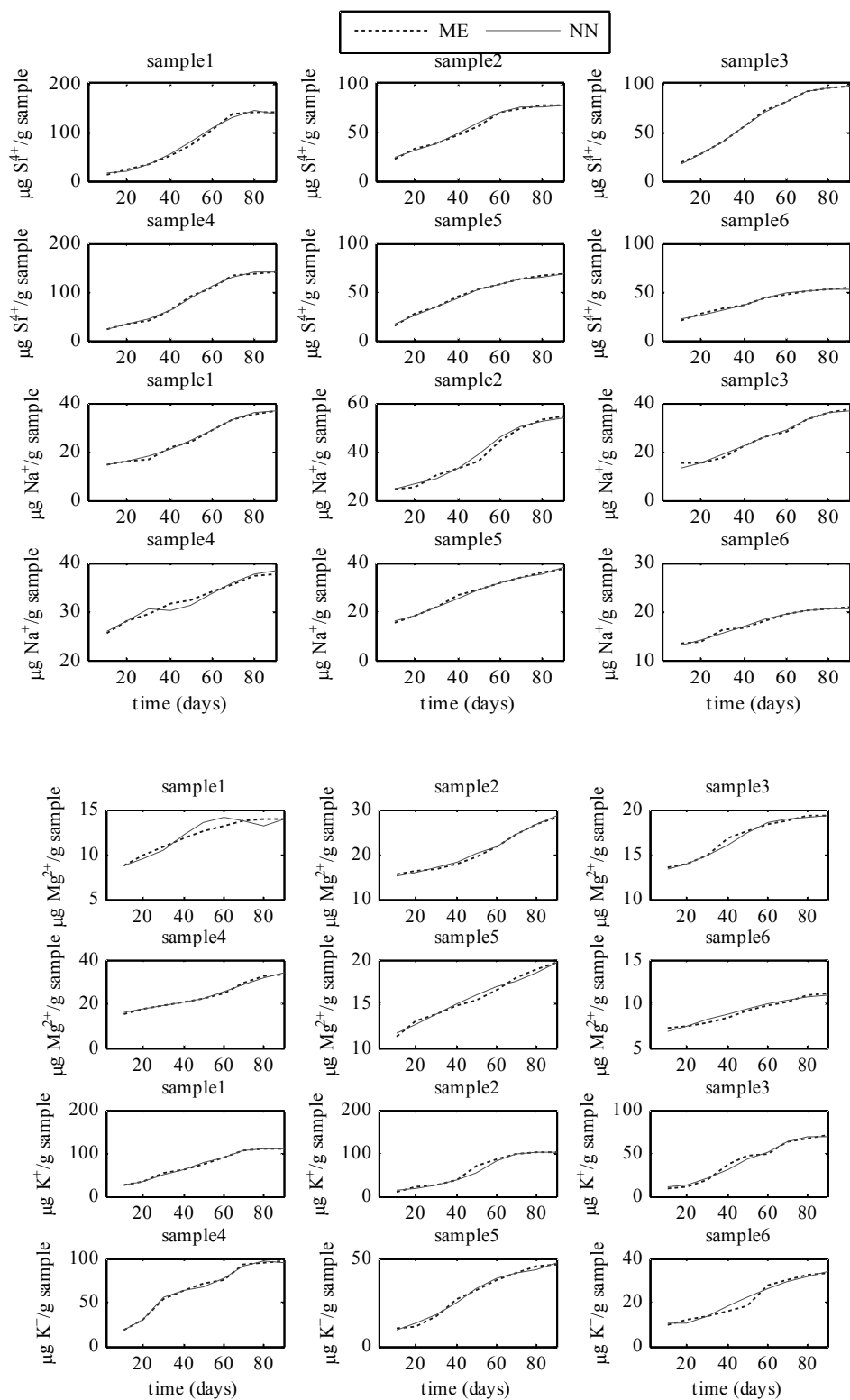


Figure 6 the comparison between the measured and computed values for  $\text{Si}^{4+}$ ,  $\text{Na}^+$ ,  $\text{Mg}^{2+}$ ,  $\text{K}^+$

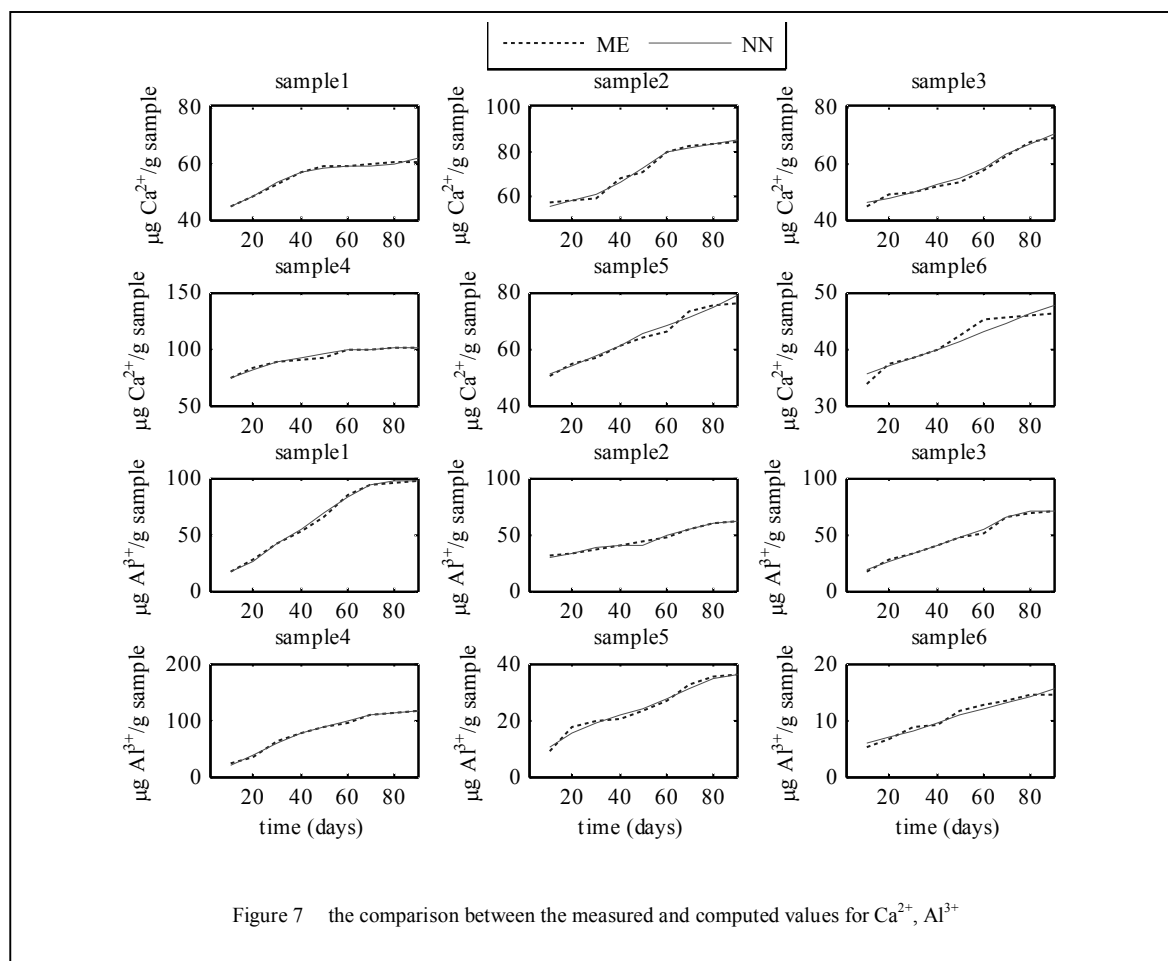


Figure 7 the comparison between the measured and computed values for  $\text{Ca}^{2+}$ ,  $\text{Al}^{3+}$

### B. the possibility of prediction of release in each type of dental porcelain with changing its components

In this situation, the system has the ability to estimate the diagram of release as the output of network after getting the data related to a new sample or changing the composition of each sample. For this purpose, sample 3 was used for testing. Considering the fact that the composition of each porcelain are chosen based on some particular criteria and definite percentages, the range of variation of these components are small and it is possible only to increase or decrease the amount of the composition in this range. For this reason, in the selected sample as the testing sample, the composition was changed in the selected range and give to the network as new inputs. Then the new out puts were depicted as the diagram of release Fig. 9. As it can be seen from Fig. 9, the observed changing in new diagrams are approximately in the range of main sample and follow its patterns. The difference, however, is that the changes in the components of powder have caused increase and sometimes decrease in release.

This characteristic gives the possibility of examining and studying the impact of changes any components of powder on the release mechanism in a simulated media and so improving the quality of powder production. To assess the accuracy of the network in detecting the system, the value and the percentage of error in each sample and for the recorded times were computed and showed in Table 3. Considering the obtained results, the mean error of network in predicting the elution rate of magnesium, calcium, potassium, sodium, silica and aluminum are 2.06, 1.51, 4.77, 2.43, 2.81 and 3.35 successively. We can say that the mentioned network has a good accuracy in estimating the behavior of dental ceramics

### 6. DISCUSSION

According to ADA and ISO standards for testing the chemical resistance and durability of dental ceramics, an acid solution must be used. In this study hydrochloric acid has been used for testing chemical resistance of dental ceramics.

TABLE III. THE RATE AND PERCENTAGE OF OBTAINED ERRORS OF EACH SAMPLES IN RECORDED TIMES

Sample	Time (day)	Comparison of the measured data (ME) and data estimated by neural network (NN)											
		$\mu\text{g Mg}^{2+} / \text{g sample}$		$\mu\text{g Ca}^{2+} / \text{g sample}$		$\mu\text{g K}^{+} / \text{g sample}$		$\mu\text{g Na}^{+} / \text{g sample}$		$\mu\text{g Si}^{4+} / \text{g sample}$		$\mu\text{g Al}^{3+} / \text{g sample}$	
		$\Delta$	$\Delta\%$	$\Delta$	$\Delta\%$	$\Delta$	$\Delta\%$	$\Delta$	$\Delta\%$	$\Delta$	$\Delta\%$	$\Delta$	$\Delta\%$
1	10	0.07	0.78	0	0.01	0.46	1.7	0.4	2.73	0.97	6.56	0.09	0.52
	20	0.35	3.69	0	0.01	1.62	4.52	0.25	1.57	1.71	8.51	0.61	2.32
	30	0.44	4.16	0.69	1.3	2.87	5.6	1.78	9.59	0.26	0.78	0.78	1.89
	40	0.32	2.65	0.46	0.81	2.07	3.29	1	4.75	1.11	2.05	2.17	3.97
	50	1.08	7.95	0.16	0.27	4.16	5.42	0.47	1.9	8.53	10.65	4.51	6.49
	60	1	7.05	0.02	0.03	0.46	0.5	0.29	1.01	2.68	2.49	1.51	1.81
	70	0.09	0.63	0.89	1.51	1.98	1.9	0.4	1.2	5.59	4.26	0.54	0.58
	80	0.68	5.15	0.84	1.41	1.17	1.07	0.61	1.68	3.99	2.78	0.92	0.95
	90	0.05	0.34	1.22	1.97	0.17	0.15	0.01	0.03	1.05	0.76	0.03	0.03
2	10	0.22	1.41	1.03	1.83	1.55	12.14	0.1	0.4	1.36	5.59	0.97	3.25
	20	0.21	1.32	0.15	0.26	2.2	11.64	1.45	5.41	2.03	6.62	0.36	1.06
	30	0.21	1.23	2.2	3.57	0.49	1.86	1.54	5.27	0.62	1.62	1.86	4.94
	40	0.6	3.28	1.98	2.97	1.6	4.12	0.05	0.14	0.97	2.01	1.19	3.01
	50	0.72	3.55	1.55	2.13	12.78	22.97	2.58	6.66	4.38	7.3	4	10.01
	60	0.19	0.88	0.48	0.6	1.95	2.32	1.85	4.01	0.21	0.3	2.21	4.47
	70	0.03	0.14	0.4	0.48	0.11	0.11	0.49	0.97	0.58	0.77	1.18	2.18
	80	0.15	0.56	0.62	0.75	1.48	1.44	0.61	1.17	0.22	0.29	0.67	1.13
	90	0.24	0.84	1.11	1.3	0.43	0.43	1.01	1.87	0.23	0.29	-0.46	-0.74
3	10	0.19	1.4	0.76	1.66	0.03	0.26	1.66	12.35	0.72	4.16	1.29	6.74
	20	0.04	0.3	1.63	3.43	1.19	9.37	0.36	2.31	0.94	3.43	1.36	5.25
	30	0.09	0.59	0.31	0.62	1.66	7.79	1.5	7.91	1.41	3.43	0.98	3
	40	0.77	4.81	0.23	0.45	4.35	13.6	0.06	0.27	-0.34	-0.61	0.7	1.76
	50	0.17	1	1.94	3.52	4.17	9.9	0.13	0.48	1.65	2.36	1.01	2.14
	60	0.34	1.83	0.35	0.6	0.75	1.49	1.18	4.05	0.61	0.75	2.53	4.68
	70	0.17	0.9	0.44	0.71	0.22	0.34	0.31	0.92	1.43	1.57	0.11	0.17
	80	0.09	0.49	0.67	1.01	1.6	2.31	0.47	1.31	1	1.04	0.48	0.69
	90	0.11	0.59	0.98	1.4	0.36	0.51	0.64	1.73	0.77	0.8	1.41	2.02
4	10	0.62	3.86	0.13	0.17	0.44	2.43	0.4	1.53	1.08	4.41	0.36	1.7
	20	0.34	1.93	1.76	2.18	0.59	1.96	0.13	0.46	1.36	4.21	0.83	2.29
	30	0.12	0.64	0.75	0.86	0.96	1.74	1	3.3	1.42	3.28	0.18	0.3
	40	0.08	0.37	1.61	1.76	0.92	1.45	1.29	4.24	1.03	1.68	0.53	0.7
	50	0.09	0.41	2.78	2.92	4.08	6.09	0.86	2.73	2.33	2.67	0.78	0.9
	60	0.29	1.16	0.23	0.24	1.95	2.53	0.64	1.9	1.74	1.54	1.88	1.94
	70	0.2	0.68	0.61	0.61	2.77	3.07	0.27	0.75	2.84	2.17	2	1.86
	80	0.44	1.37	0.13	0.13	2.47	2.54	0.25	0.67	1.54	1.1	0.1	0.09
	90	0.35	1.05	0.89	0.88	1.3	1.37	0.53	1.37	0.04	0.03	0.59	0.51
5	10	0.32	2.75	0.17	0.33	0.84	9.02	0.64	3.99	0.81	4.87	1.21	11.72
	20	0.33	2.59	1.14	2.11	1.23	9.65	0.14	0.76	1.6	6.25	1.95	12.51
	30	0.06	0.45	0.82	1.43	0.74	4.14	0.05	0.24	1.09	3.08	0.37	1.92
	40	0.05	0.36	0.6	0.98	2.31	9.35	1.16	4.54	1.13	2.53	1.7	7.8
	50	0.56	3.51	1.4	2.15	0.92	2.8	0.41	1.41	0.39	0.74	0.68	2.81
	60	0.39	2.3	2.03	2.97	1.71	4.37	0.33	1.04	0.85	1.45	0.47	1.7
	70	0.25	1.41	1.87	2.63	0.68	1.61	0.6	1.8	0.1	0.17	0.99	3.15
	80	0.46	2.48	1.38	1.85	1.58	3.62	0.71	2	0.48	0.73	1.31	3.82
	90	0	0.01	2.32	2.95	1.1	2.31	0.49	1.28	0.6	0.88	0.15	0.41
6	10	0.24	3.48	1.6	4.52	0.49	4.66	0.34	2.58	2.09	9.5	0.79	13.28
	20	0.18	2.34	0.35	0.94	1.51	13.83	0.56	3.92	1.62	6.26	0.19	2.77
	30	0.31	3.79	0.09	0.23	0.12	0.88	0.71	4.55	1.76	5.63	0.77	9.63
	40	0.37	4.13	0.03	0.07	2.48	13.63	0.39	2.31	0.7	1.89	0.17	1.82
	50	0.23	2.43	1.23	2.99	3.92	17.45	0.31	1.67	0.05	0.11	0.76	7.08
	60	0.22	2.17	2.14	4.99	1.3	4.94	0.04	0.2	0.27	0.56	0.54	4.51
	70	0.26	2.54	0.95	2.13	0.65	2.19	0	0	1.08	2.09	0.31	2.38
	80	0.29	2.71	0.25	0.54	0.33	1.02	0.02	0.08	0.32	0.61	0.19	1.35
	90	0.35	3.17	1.66	3.47	0.8	2.32	0.11	0.54	1.04	1.97	1.02	6.51

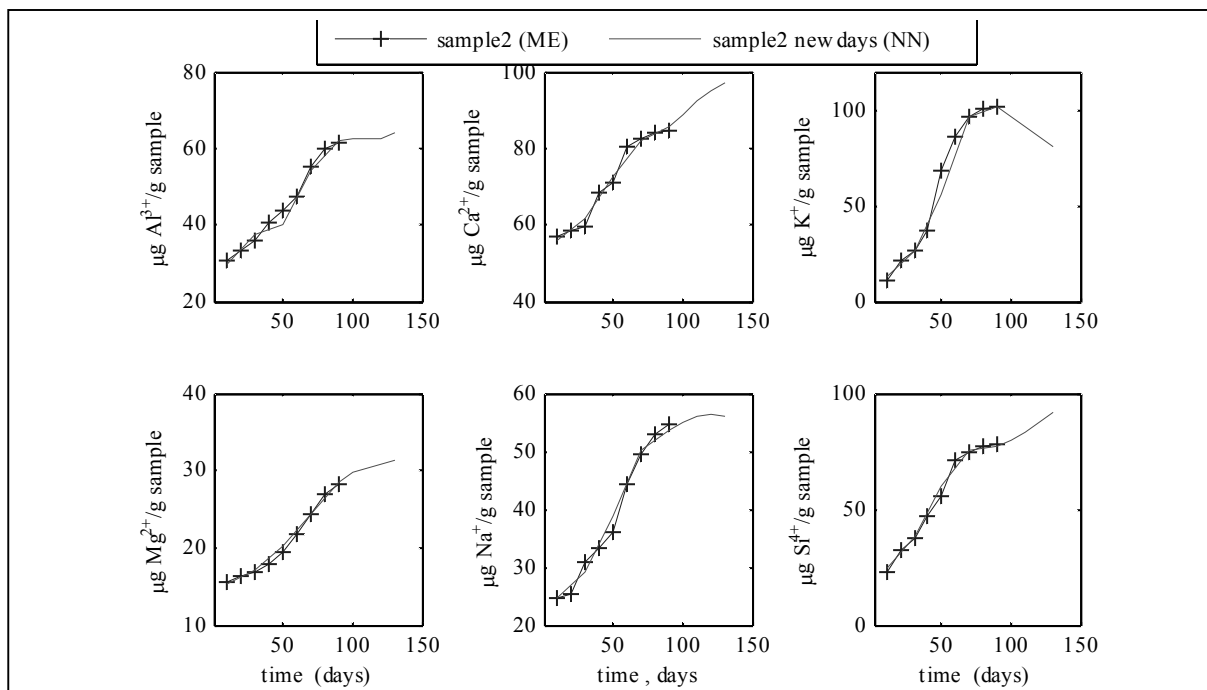


Figure 8 the results of network prediction for a long period

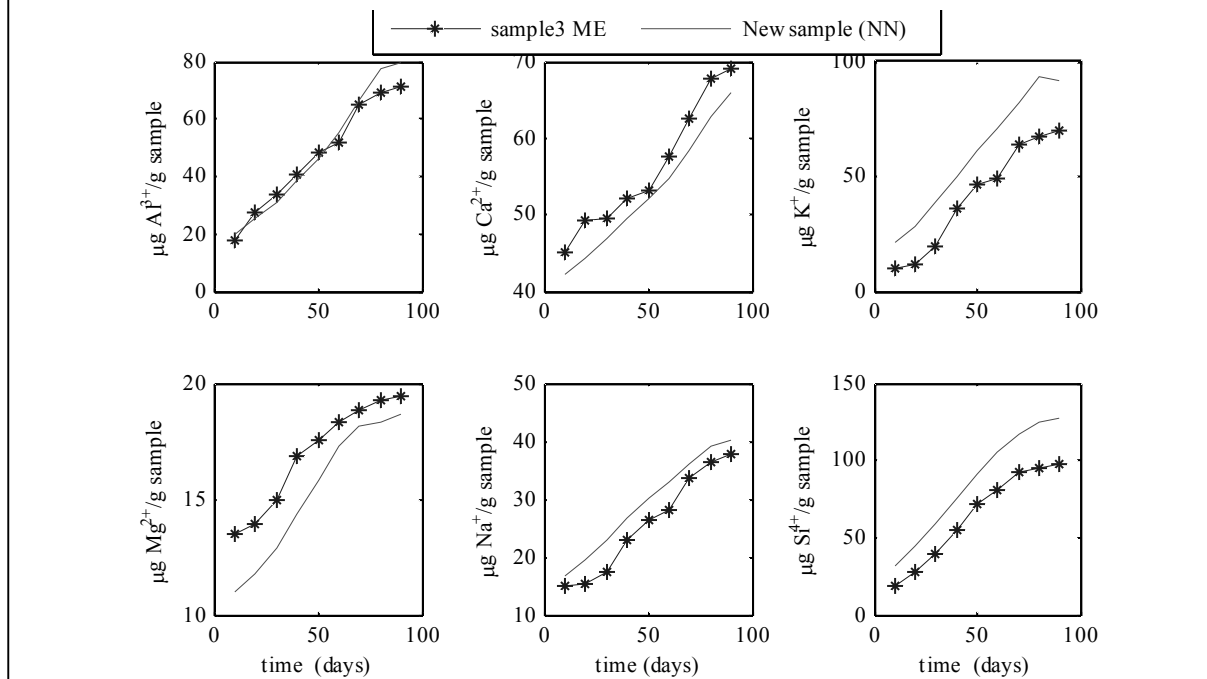


Figure 9 the results of network prediction with changing the compositions

Hydrochloric acid was suitable because there a lot of patients with gastric disorders that have lower pH values in oral cavity due to the presence of hydrochloric acid. Also the length of this experiment differed from

ISO standard. It was also desirable to include in this research the longest possible elution of ions from dental ceramics in order to test the long term predicting possibilities of this method. The artificial neural

network method presented in this study is currently been used in different fields of engineering, medicine and etc. The application of experimental data in this study was using them in training and testing the network and finally extracting a model according to practical results. The results of past studies confirmed this hypothesis that the elution of ions from the surface of dental ceramics in an acid solution is slightly carried out. Despite the fact the number of data and measuring time intervals were relatively low, even in the method of artificial neural networks showed a very accurate prediction of the wear behavior of dental ceramics. The observation of high correlation coefficient and low normalized root mean square error between measured and estimated output values approve the network's capability in learning and extracting the model of the system. The only problem was small number of input data sets and type of information given to network i.e. input data sets used to train the network, were only about the component of materials used for making each porcelain. Even though some other parameters such as productivity of each powder, effecting factors in sintering process, the created phase and... are effective in the mechanism of release which haven't been considered in this research. Because of this reason, extraction of a very accurate model for the system was impossible while in the small number of information the minimum and least difference obtained between the measured and estimated mass of eluted ions per gram of dental ceramic sample were observed. Artificial neural network has a great potential for investigating not only the chemical stability of materials, but also other properties such as wear resistance, flexural strength and etc. Artificial neural networks have great potentials, for example it is possible to calculate, compute and evaluate the amount of eluted ions, without needing to experiments and spending time and high cost. Moreover, the system making a virtual experimental medium that gives possibility to dental porcelain manufacturers to change the percent of chemical composition used for making each powder as a software and studying the changes in the amount of ion elution from its surface in an interval and in this way obtaining the most optimum combination for a powder with lost elution. Comparing pH and release diagrams in each sample, it is observed that as an average, the maximum pH increase takes place in samples with maximum elution. In other words, the amount of elution is proportionate to the pH variation. It can be concluded that the pH increase is related to the increasing amount of ion elution from the surface of porcelain and making junctions with OH groups existing in the solution. Then, the acidity of solution and increment of amount of eluted ions decreases and pH increases. Since studying the papers about pH variation based on time, the

maximum increase of pH is in the first three months and after that its amount changes with a constant rate. So in this study, the amounts of pH recordings were also examined up to the third month. In addition, as it was evaluated before, the amount of ion elution from the surface of porcelain is proportionate to the rate of pH variations. Therefore, it is estimated that the rate of elution after three months remains stable. The authenticity of results by neural network according to predictions after stimulating and drawing the graphs of elution in period more than 90 days Fig. 8 was confirmed i.e. as it was anticipated after the third month as an average the amount of elution approximately remained stable. In related graphs to pH Fig. 4, sample1 (.) and sample2 (+) have erratic movements. In sample 2 the amount of pH has a slight rise up to fifteenth day but then the amount of pH dramatically changes. Comparing this diagram with other diagrams related to elution in Fig 3, it was observed that in the diagram of sodium release, this sample has had a sharp rise after 50<sup>th</sup> day. Also in sample 1 the amount of pH was increasing regularly up to 40<sup>th</sup> day but after that it suddenly soared up. Also the in the diagram related to the potassium elution is observed in this sample. It can be concluded that the most critical factor in pH variations is related to the elution of sodium and potassium because sudden increase of these two ions in comparison with other ions has had more impact on pH variations

#### Acknowledgement

The authors would like to thank Tabriz Branch, Islamic Azad University for the financial support of this research, which is based on a research project contract.

#### REFERENCES

- [1] Jasenka Zivko-Babic, Dragutin Lisjakk, "Estimation of chemical resistance of dental ceramics by neural network" dental materials, vol. 24, pp. 18–27, 2008
- [2] ISO 6872. International standards for dental ceramics. Geneva, Switzerland: International Organization for Standardization; 1995.
- [3] American National Standard/American Dental Association. Specification No. 69. Dental ceramics. Chicago: Council on Dental Materials, Instruments and Equipment; 1991.
- [4] Richard Van Noort, "Introduction to Dental Materials", Sep 27, 2007
- [5] J. Zivko-Babic, L. Curkovic, "Chemical durability of alumina dental ceramic" Proceedings of the 17<sup>th</sup> international research/expert conference. Pp. 257–9, 2003.
- [6] J. Zivko-Babic, L. Curkovic, "A. Measurement of ions release from dental ceramics", Proceedings of the 28th annual conference of EPA, pp. 102, 2004.
- [7] RM. Golden, "Mathematical methods for neural networks analysis and design", Bradford book, MIT Press, 1996.
- [8] The MathWorks, Neural Network Toolbox, <http://www.mathworks.com>, Inc. 2006

9/6/2012

## Long-term Resveratrol Administration Reduces Renal Oxidative Stress and Apoptosis Rate In Experimental Model of Type 2 Diabetes.

Saeed Khamneh<sup>1</sup>, Farhad Ghadiri Soufi<sup>2</sup>, Fatemeh Afshar<sup>3</sup>

<sup>1</sup> Department of Physiology, Islamic Azad University, Tabriz branch, Tabriz, Iran.

<sup>2</sup> Department of Physiology, Faculty of medicine, Hormozgan University of Medical Sciences, Bandar Abbas, Iran.

<sup>3</sup> Department of Histopathology, Islamic Azad University, Tabriz branch, Tabriz, Iran.

**Corresponding author:** Dr. Saeed Khamnei (Professor of physiology; MD, PhD), Department of physiology, Islamic Azad University, Tabriz branch, Tabriz, Iran. Tel: +9809141165717; Fax: +9804113364664; Email: Khamnei-s@iaut.ac.ir

**Abstract:** The present study was designed to evaluate whether long-term resveratrol administration has beneficial effects on renal oxidative stress and apoptosis rate in diabetic rats. Male Wistar rats were divided into four groups (n=6): normal control, diabetic control, normal rats treated with resveratrol, and diabetic rats treated with resveratrol. Diabetes was induced by injection of streptozotocin (50 mg/kg; *i.p.*), 15 min after the prescription of nicotinamide (110 mg/kg; *i.p.*) in 12 h fasted rats. **RESULTS:** Four-month oral resveratrol prescriptions (5 mg/kg/day) significantly attenuated the enhancement of blood glucose, glycosylated hemoglobin, urea, and creatinine and 8-isoprostane levels in diabetic rats. Moreover, resveratrol administration to diabetic rats improved the reduced levels of glutathione, total antioxidant capacity and the antioxidant enzymes activities (superoxide dismutase, glutathione peroxidase and catalase). The apoptosis rate significantly increased in the renal of diabetic groups as compared with normal groups. Treatment with resveratrol reduced this enhancement statistically. These results suggest that chronic resveratrol administration is safe and effective and also may be considered as a therapeutic compound in diabetes. [Saeed Khamneh, Farhad Ghadiri Soufi, Fatemeh Afshar. **Long-term Resveratrol Administration Reduces Renal Oxidative Stress and Apoptosis Rate In Experimental Model of Type 2 Diabetes.** *Life Sci J* 2012;9(4):2997-3001]. (ISSN: 1097-8135). <http://www.lifesciencesite.com>. 440

**Key words:** Diabetes, Resveratrol, hyperglycemia, Oxidative stress, Cell death.

### 1. Introduction

Diabetes mellitus, a chronic and progressive metabolic disorder, is a challenging public health problem and nowadays, diabetic nephropathy and its-related renal failure are one of the most important contributing mortality factors in developing countries (Luis-Rodríguez *et al.*, 2012; Balakumar *et al.* 2009). Although the pathogenesis of diabetic nephropathy is multifactorial hyperglycemia-induced oxidative stress plays a crucial role (Palsamy and Subramanian, 2011; Kitada *et al.*, 2011; Chang *et al.*, 2011).

Diabetes-related hyperglycemia is resulted from insufficient secretion or action of endogenous insulin and induces oxidative stress via enhancement of glucose oxidation, advanced glycation end products, protein kinase C, hexosamine and polyol pathways fluxes and pro-inflammatory cytokines (Rains and Jain, 2011). It widely has been accepted that oxidative stress, an imbalance between production and detoxification of oxygen/nitrogen-free radicals, plays a key role in the onset and development of diabetes complications. Peroxidation or glycation of lipids, proteins and DNA, reduction of antioxidants defenses and progression of tissues inflammations are some disturbances, which are induced by oxidative stress (Rains and Jain, 2011). During the past decades, some approaches (such as diet, exercise, insulin therapy and

antidiabetic drugs) have provided to diminish diabetes complications. In order to antidiabetic drugs side effects (such as hypoglycemia, diarrhea, hepatotoxicity, dyslipidemia, lactic acidosis and hypercoagulability) (Palsamy and Subramanian, 2008), there is a great need to focus on additional therapeutics with negligible adverse effects, which would improve diabetic patient's health problems.

Resveratrol (trans-3, 5, 4'-trihydroxystilbene, discovered in 1940s) is a polyphenolic phytoalexin present in different plants such as grapes, peanuts and berries (Cottart *et al.*, 2010). Numerous *in vivo* and *in vitro* studies have been reported that resveratrol has many beneficial properties such as lifespan extending, antioxidant, anti-inflammatory, anticancer, anticoagulant, cardioprotective and vasoprotective effects (Szkudelska and Szkudelski, 2010; Csiszar, 2011; Lee *et al.*, 2011). In regard to the central role of oxidative stress in the pathogenesis of diabetes, in the recent years, numerous investigations have focused on the role of resveratrol in prevention or treatment of diabetic nephropathy (Palsamy and Subramanian, 2011; Kitada *et al.*, 2011; Chang *et al.*, 2011; Chen *et al.*, 2011). In this regard, it has been reported that short-term treatment of resveratrol (3-8 weeks) has been beneficial renoprotective effects, mainly via reducing Oxidative stress and enhancement of

antioxidants enzymes activities (Palsamy and Subramanian, 2011; Kitada *et al.*, 2011; Chang *et al.*, 2011). On the other hand, to date, no serious side effects were reported for long-term resveratrol treatment in healthy subjects during *in vitro* and *in vivo* studies (Cottart *et al.*, 2010).

Currently, resveratrol has become available in pill forms as a dietary supplement and based on previous studies, it seems that short-term prescription of resveratrol to be useful, safe and well tolerated. In order to poor information about long-term administration of resveratrol in chronic disorders such as diabetes mellitus and cancers, a requirement to further investigations to determine its efficacy for the treatment of diabetic patients, has been previously suggested (Cottart *et al.*, 2010). The present study was designed to evaluate whether chronic administration of resveratrol can attenuate oxidative stress and apoptosis rate in the kidney of streptozotocin (STZ)-nicotinamide model of diabetic rats

## 2. Material and Methods

### 2.1. Experimental design

Male Wistar rats (Razi Institute, Tehran, Iran) weighing 320-350 g were housed at room temperature (22-25 °C) with 12:12-h light/dark cycles and free access to food and water. Rats were randomly divided into four groups (6 in each): normal control (NC), diabetic control (DC), normal control treated with resveratrol (NTR), and diabetic treated with resveratrol (DTR). The study protocol was designed in accordance with NIH guidelines for the care and use of laboratory animals and based on the method of Palsamy and Subramanian (2008). Diabetes was induced by injection of STZ (50 mg/kg; i.p.) dissolved in 0.1 M of citrate buffer (pH 4.5), 15 min after the prescription of nicotinamide (110 mg/kg; i.p.) in 12 h fasted rats. Citrate buffer were injected alone in control rats. Nicotinamide preserves the pancreatic  $\beta$ -cells (up to 40 %) from STZ cytotoxicity and produces NIDDM similar to human NIDDM (Masiello *et al.*, 1998). To prevent from the fatal hypoglycemic effect of pancreatic insulin release, 10 % glucose solution, were provided for the rats 6 h after STZ injection for the next 24 h. After 48 h blood glucose levels were measured using glucometer (Arkray, Kyoto, Japan) and the rats with blood glucose levels higher than 250 mg/dl were included to the protocol as diabetic rats. Resveratrol treatment (5 mg/kg) was carried out orally in aqueous solution for four months. The dosage was regulated every week. At the end of experimental period, fasted rats were anesthetized with ketamine (80 mg/kg) and blood samples (5 ml) were collected from each rat for biochemical measurements. Then, the rats were killed by cervical decapitation, the kidneys quickly removed, weighted and washed in cold saline and frozen at -80 °C. All manipulations take placed in

morning. All above chemicals (except resveratrol) were purchased from Sigma (Sigma, St. Louis, MO, USA). Resveratrol was obtained from Cayman chemicals (Cayman chem., Ann Arbor, MI, USA).

### Biochemical measurements

Blood glucose, glycosylated hemoglobin (HbA1c), urea and creatinine were measured spectrophotometrically by the zistshimi lab Kits (Roghani and Baluchnejadmojarad, 2010).

### 2.2. Oxidative stress measurements

Evaluation of the kidney was carried out by measurements of antioxidant enzymes activities (superoxide dismutase; SOD, glutathione peroxidase; GPx, and catalase; CAT), the levels of glutathione (GSH) and 8-Isoprostane colorometrically, using the Cayman chemicals assay kits (Cayman chem., Ann Arbor, MI, USA) in accordance to manufacturer's instructions. Tissue preparation was performed by homogenizing of the same portion of the right kidneys (50 mg) in ice-cold buffer containing 10 mM NaCl, 2 mM MgCl<sub>2</sub>, 10 mM HEPES, 20% glycerol, 0.1% Triton X-100, 1 mM dithiothreitol, 3  $\mu$ l of 1 M of 10% P-40, complete protease inhibitor cocktail, pH 7.4 for 15 min. After centrifugation at 14000 g for 10 min at 4°C, the supernatant containing the cytoplasmic protein fraction was used for determination of cell death detection and oxidative stress markers. Cayman protein determination kit (Item No: 704002) was used to quantitate protein concentrations.

### 2.3. Quantification of apoptosis

Cell death detection ELISA kit (1544675, Roche, Germany) was used to quantitatively detect the cytosolic histone-associated DNA fragmentation, based on the manufacturer's instructions. Renal cytoplasmic extracts (25  $\mu$ l) were used as an antigen source in a sandwich ELISA. The change in color was measured at a wavelength of 405 nm by using a Dynex MRX plate reader controlled through PC software (Revelation, Dynatech Laboratories, CA). The OD reading was then normalized to the total amount of protein in the sample and the data were reported as an apoptotic index (OD<sub>405</sub>/mg protein) to indicate the level of cell death.

### 2.4. Data analysis

Data were expressed as mean  $\pm$  SD and were analyzed by One-way ANOVA, using SPSS 18 software. When a significant p-value was obtained, the Tukey post-hoc test was employed to determine the differences between groups. A level of p < 0.05 was considered statistically significance.

## 3. Results

The changes in biochemical measurements and renal and body weights have been presented in Table 1. Although significant weight loss occurred in both diabetic groups, but this weight loss in DRT group was markedly lower than DC group (p < 0.01 for all



comparisons). We did not see significant changes in body weights between NTR and NC groups.

In comparison to the NC group, blood glucose concentration increased in DC and DRT groups ( $p < 0.01$  for both); however, its level in DRT group was significantly lower than DC group ( $p < 0.01$ ). Four-month treatments with resveratrol have not significant effect on the nondiabetic rat's blood glucose level statistically.

The levels of urea, creatinine and HbA1c were higher in both diabetic groups ( $p < 0.01$  for all comparisons) when compared with NC group (table 1). Four-month treatments with resveratrol statistically reduced HbA1c, urea and creatinine levels in DRT group when compared with DC group ( $p < 0.01$  for all). Table 1: Effect of 4-month oral resveratrol administration on body weight, renal weight and blood biochemistry.

Groups	Normal Control (NC)	Diabetic Control (DC)	Normal Treated with Resveratrol (NTR)	Diabetic Treated with Resveratrol (DTR)
Body weight (g)	376.41 ± 5.61	229.91 ± 4.76*	352.63 ± 6.08	272.59 ± 8.19*#
Glucose (mg/dl)	104.29 ± 3.44	421.58 ± 5.01*	97.91 ± 4.96	356.17 ± 5.29*#
HbA1c (% Hb)	7.46 ± 0.12	16.61 ± 0.20*	8.11 ± 0.17	12.17 ± 0.14*#
Creatinine (mg/dl)	0.69 ± 0.02	1.73 ± 0.03*	0.74 ± 0.03	1.23 ± 0.03*#
Urea (mg/dl)	16.50 ± 1.2	59.44 ± 2.9*	19.16 ± 2.6	35.24 ± 1.4*#

The values represent mean ± SD of 6 animals per group. \*  $p < 0.01$  versus normal control group (NC). #  $p < 0.01$  versus diabetic control group (DC). SOD: superoxide dismutase, GPX: glutathione peroxidase, CAT: catalase, GSH: glutathione, ALT: alanine transaminase, AST: aspartate transaminase, and ALP: alkaline phosphatase.

Table 2 also represents the effects of chronic resveratrol treatment on renal oxidative stress. In comparison to the NC group, treatment with resveratrol enhanced SOD activity and reduced 8-Isoprostane level in NTR group, while it has no effect on GPx and CAT activities and the level of GSH ( $p < 0.01$  for all comparisons). In both diabetic groups, the activities of all antioxidant enzymes (SOD, GPx and CAT) and the levels of GSH were decreased, and the levels of 8-Isoprostane were increased when compared with NC group; Treatment with resveratrol was markedly attenuated these changes ( $p < 0.01$  for all comparisons).

Figure 1 depicts that the apoptosis rate significantly increased in the renal of DC and DTR groups as compared with normal groups ( $p < 0.01$  for DC group and  $p < 0.05$  for DTR group comparisons). Treatment with resveratrol reduced this enhancement statistically ( $p < 0.05$ ). There was no significant difference in apoptosis rate between NTR and NC groups.

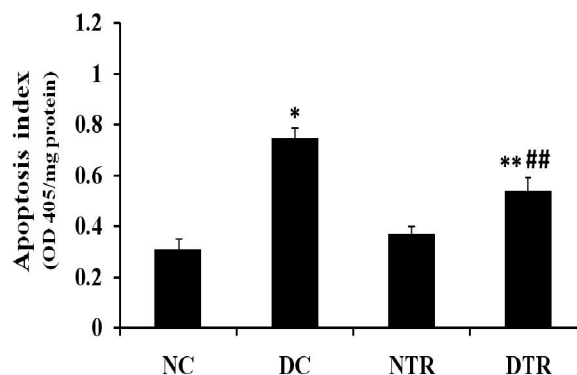


Figure 1: Effect of four months resveratrol administration on the renal apoptosis rate in diabetic rats. The values represent mean ± SD of 6 animals per group. \*  $p < 0.01$  and \*\*  $p < 0.05$  versus normal control group (NC). ##  $p < 0.05$  versus diabetic control group (DC). NTR: normal rats treated with resveratrol, and DTR: diabetic rats treated with resveratrol.

Table 2: Effects of chronic resveratrol treatment on renal oxidative stress.

Groups	Normal Control (NC)	Diabetic Control (DC)	Normal Treated with Resveratrol (NTR)	Diabetic Treated with Resveratrol (DTR)
8-Isoprostane (pg/ml)	877.2 ± 12.38	1513.6 ± 9.30*	833.4 ± 11.01*	1157.9 ± 16.1*#
GSH (μmol/ml)	23.82 ± 1.17	11.61 ± 1.03*	19.15 ± 1.19	16.13 ± 0.88*#
SOD (U/g Hb)	249.26 ± 11.8	146.19 ± 19.6*	332.21 ± 15.3*	211.18 ± 10.6*#
GPX (U/g Hb)	357.21 ± 21.3	189.34 ± 18.6*	366.91 ± 11.9	261.77 ± 9.44*#
CAT (nmol/min/ml)	3.21 ± 0.16	1.03 ± 0.07*	2.66 ± 0.11	1.79 ± 0.14*#

The values represent mean ± SD of 6 animals per group. \*  $p < 0.01$  versus normal control group (NC). #  $p < 0.01$  versus diabetic control group (DC). SOD: superoxide dismutase, GPX: glutathione peroxidase, CAT: catalase, GSH: glutathione

#### 4. Discussion

Insufficient secretion or action of insulin causes hyperglycemia, mainly via an enhanced release of glucose by the liver and reduced utilization of glucose

in peripheral tissues. In this situation, the body has to provide itself energy by degradation of proteins and lipids from their reservoirs, which ultimately accounts for accumulation of protein and lipid by/end products

(such as urea, creatinine, free fatty acids, triglyceride and cholesterol), reduction of plasma total proteins and finally weight loss (Palsamy and Subramanian, 2008; Roghani and Baluchnejadmojarad, 2010). It should be noticed that, liver or kidney malfunction induced by chronic hyperglycemia, in turn, reduces plasma proteins, enhances proteinuria, accumulates urea and creatinine and accelerates weight loss (Palsamy and Subramanian, 2008). Our results showed that blood glucose, urea and creatinine concentrations markedly elevated after four months of diabetes and concomitantly body weight decreased during this period. Alleviation of these disturbances with resveratrol treatment, suggest that chronic administration of resveratrol has been beneficial antidiabetic effects.

Oxidation of glucose is one of the mechanisms involved in pathogenesis of diabetes complications (Maritim *et al.*, 2003). Glucose oxidation enhances glycation of proteins such as hemoglobin (and produces HbA1c) and antioxidant enzymes which in turn, can reduce their activities for detoxification of reactive oxygen/nitrogen-free radicals and lead to lipids, proteins and DNA peroxidation and finally programmed cell death (Rains and Jain, 2011). The concentration of HbA1c is considered as a good marker for diagnosis and prognosis of diabetes complications. Although the anti-hyperglycemic effect of chronic resveratrol administration was small in this study, but it reduced HbA1c approximately 4.44%. It has been reported that, there is strong correlation between HbA1c and risk of diabetic retinopathy, nephropathy and neuropathy (Howlett and Ashwell, 2008) and reduction of HbA1c by only 1 unit (8% to 7%) can reduce the risk of retinopathy by over 30% (Kowluru and Chan, 2007).

8-Isoprostane (8-*iso* prostaglandin  $F_{2\alpha}$ ), a member of eicosanoids family producing by the oxidation of tissue phospholipids by oxygen radicals, has been proposed as a marker of antioxidant deficiency and oxidative stress (Morrow *et al.*, 1995). It has been shown that plasma concentration of 8-isoprostane increases with diabetes-induced lipid peroxidation and oxidative stress (Ndisang *et al.*, 2010; Salim *et al.*, 2010). Reducing of 8-isoprostane concentrations in normal and diabetic rats after the 4-month period of resveratrol treatment shows that resveratrol has a strong antioxidant effect and attenuates oxidative stress.

Dismutation of superoxide radicals (the most abundant reactive oxygen radical producing in the cells) to hydrogen peroxide is the first step in detoxification of reactive oxygen/nitrogen species. Then, hydrogen peroxide is metabolized into water by the activities of CAT and GPx. Moreover, GSH, a co-substrate for GPx activity, is a major intracellular

antioxidant molecule and acts as a direct free radical scavenger (Palsamy and Subramanian, 2010). Antioxidant machinery impairment due to antioxidant enzymes and other proteins glycation have been previously reported (Palsamy and Subramanian, 2010). On the other hand, Davi *et al.* have shown that following the activation of polyol pathway and consumption of NADH, GSH availability for efficient function of GPx reduces in diabetes mellitus (Davi *et al.*, 2005). Our data shown that after four months of diabetic state, GSH concentrations as well as SOD, GPx and CAT activities decreased in both diabetic groups (table 2). Chronic resveratrol administration not only attenuated observed antioxidant machinery impairments in diabetic rats, but also it increased SOD and CAT activities in normal rats. These results are in line with obtained results from studies administering resveratrol for shorter time (Palsamy and Subramanian, 2011; Kitada *et al.*, 2011; Chang *et al.*, 2011). This observation suggests that the antioxidant properties of resveratrol may be accomplished directly or through reducing blood glucose. Schmatz *et al.* have previously proposed that antioxidant effect of resveratrol do not depend on its hypoglycemic property (Schmatz *et al.* 2009).

Many of above mentioned hyperglycemia-induced pathways converge to elevate NF- $\kappa$ B, a proinflammatory master switch, which activates proinflammatory cytokines gene expressions and apoptosis cascade (Kern 2007, Palsamy and Subramanian, 2010). Our data also are in line with previous studies, in which the renal apoptosis rates in DC and DTR groups were significantly higher than normal controls (Barber *et al.* 2011, Kern 2007). Reducing renal apoptosis rates after 4-month resveratrol intake is another certification to support the beneficial effect of resveratrol in preventing diabetes complications.

In conclusion, our results depict that chronic treatment with resveratrol has an effective anti-hyperglycemic effect, leading to reduction in HbA1c level in diabetic rats. Moreover, it reduced renal antioxidant machinery impairment, apoptosis rate and some diabetic complication markers, including blood urea and creatinine concentrations. It is possible that resveratrol improves cellular functions through reducing oxidative stress which in turn, reduces diabetes-induced hyperglycemia and its related complications. Similar to the obtained results previously from short-term administration of resveratrol, our results suggest that, chronic resveratrol administration is safe and effective and also may be considered as a therapeutic compound in diabetes.

#### **Acknowledgements**

The authors would like to thank Tabriz Branch, Islamic Azad University for the financial support of

this research, which is based on a research project contract.

### Conflict of interest

The authors have declared that there is no conflict of interest.

### References

- Balakumar, P., V.A. Chakkarwar and M. Singh, 2009. Ameliorative effect of combination of benfotiamine and fenofibrate in diabetes-induced vascular endothelial dysfunction and nephropathy in the rat. *Mol.Cell.Biochem.*, 320:149–162.
- Barber A.J., T.W. Gardner and S.F. Abcouwer, 2011. The significance of vascular and neural apoptosis to the pathology of diabetic retinopathy. *Invest. Ophthalmol. Vis. Sci.*, 52:1156-1163.
- [Chang C.C.](#), C.Y. [Chang](#), Y.T. [Wu](#), J.P. [Huang](#) and T.H. [Yen](#) *et al.*, 2011. Resveratrol retards progression of diabetic nephropathy through modulations of oxidative stress, proinflammatory cytokines, and AMP-activated protein kinase. *J. Biomed. Sci.*, 18:47-56.
- [Chen K.H.](#), C.C. [Hung](#), H.H. [Hsu](#), Y.H. [Jing](#) and C.W. [Yang](#) *et al.*, 2011. Resveratrol ameliorates early diabetic nephropathy associated with suppression of augmented TGF- $\beta$ /smad and ERK1/2 signaling in streptozotocin-induced diabetic rats. *Chem. Biol. Interact.*, 190:45-53.
- Csiszar A., 2011. Anti-inflammatory effects of resveratrol: possible role in prevention of age-related cardiovascular disease. *Ann. N. Y. Acad. Sci.*, 1215:117-122.
- Cottart C.H., V. Nivet-Antoine, C. Laguillier-Morizot and J.L. Beaudoux, 2010. Resveratrol bioavailability and toxicity in humans. *Mol. Nutr. Food. Res.*, 54:7-16.
- Davi G., A. Falco and C. Patrono, 2005. Lipid peroxidation in diabetes mellitus. *Antioxid. Redox. Signal.*, 7: 256-268.
- Howlett J. and M. Ashwell, 2008. Glycemic response and health: summary of a workshop. *Am. J. Clin. Nutr.*, 87: 212S-216S.
- Kern T.S., 2007. Contributions of inflammatory processes to the development of the early stages of diabetic retinopathy. *Exp. Diabetes. Res.*, 2007: 95103.
- [Kitada M.](#), S. [Kume](#), N. [Imaizumi](#) and D [Koya](#), 2011. Resveratrol improves oxidative stress and protects against diabetic nephropathy through normalization of Mn-SOD dysfunction in AMPK/SIRT1-independent pathway. *Diabetes*, 60:634-643.
- Lee S.M., H. Yang, D.M. Tartar, B. Gao and X. Luo *et al.*, 2011. Prevention and treatment of diabetes with resveratrol in a non-obese mouse model of type 1 diabetes. *Diabetologia*, 54:1136-1146.
- Luis-Rodríguez D., Martínez-Castelao A., Górriz J.L., De-Álvaro F., Navarro-González J.F. 2012 [Pathophysiological role and therapeutic implications of inflammation in diabetic nephropathy](#). *World J Diabetes* 15:7-18.
- Maritim A.C., R.A. Sanders and J.B. Watkins III, 2003. Diabetes, oxidative stress, and antioxidants: a review. *J. Biochem. Mol. Toxicol.*, 17:24-38.
- Masiello P., C. Broca, R. Gross, M. Roye and M. Manteghetti *et al.*, 1998. Experimental NIDDM: development of a new model in adult rats administered streptozotocin and nicotinamide. *Diabetes*, 47:224-229.
- Morrow J.D., B. Frei, A.W. Longmire, J.M. [Gaziano](#) and S.M. [Lynch](#) *et al.*, 1995. Increase in circulating products of lipid peroxidation (F<sub>2</sub>-isoprostane) in smokers. *N. Engl. J. Med.*, 332:1198-1203.
- Ndisang J.F., N. Lane, N. Syed and A. Jadhav, 2010. Up-regulating the heme oxygenase system with hemin improves insulin sensitivity and glucose metabolism in adult spontaneously hypertensive rats. *Endocrinology*, 151:549-560.
- Palsamy P. and S. Subramanian, 2008. Resveratrol, a natural phytoalexin, normalizes hyperglycemia in streptozotocin-nicotinamide induced experimental diabetic rats. *Biomed. Pharmacother.*, 62:598-605.
- Palsamy P. and S. Subramanian, 2010. Ameliorative potential of resveratrol on proinflammatory cytokines, hyperglycemia mediated oxidative stress, and pancreatic  $\beta$ -cell dysfunction in streptozotocin-nicotinamide-induced diabetic rats. *J. Cell. Physiol.*, 224:423-432.
- Palsamy P. and S. Subramanian, 2011. Resveratrol protects diabetic kidney by attenuating hyperglycemia-mediated oxidative stress and renal inflammatory cytokines via Nrf2-Keap1 signaling. *Biochim. Biophys. Acta.*, 1812:719-731.
- Pitocco D., F. Zaccardi, E. Di Stasio, F. Romitelli and S.A. Santini *et al.*, 2010. Oxidative Stress, Nitric Oxide, and Diabetes. *Rev. Diabet. Stud.*, 7:15-25.
- Rains J.L. and S.K., 2011. Jain Oxidative stress, insulin signaling, and diabetes. *Free. Radic. Biol. Med.*, 50:567-575.
- Roghani M. and T. Baluchnejadmojarad, 2010. Mechanisms underlying vascular effect of chronic resveratrol in streptozotocin-diabetic rats. *Phytother. Res.*, 24, S148-S154.
- Salim S., M. Asghar, G. Chugh, M. Taneja and Xia Z *et al.*, 2010. Oxidative stress: a potential recipe for anxiety, hypertension and insulin resistance. *Brain. Res.*, 1359:178-185.
- Schmatz R., M.R. Schetinger, R.M. Spanevello, C.M. Mazzanti and N. Stefanello *et al.*, 2009. Effect of resveratrol on nucleotide degradig enzymes in streptozotocin-induced diabetic rats. *Life. Sci.*, 84:345-350.
- Szkudelska K. and T. Szkudelski, 2010. Resveratrol, obesity and diabetes. *Euro. J. Pharmacol.* 635:1-8.
- Szkudelski T and K., 2011. Szkudelska Anti-diabetic effects of resveratrol. *Ann. N. Y. Acad. Sci.* 1215: 34-39.

9/6/2012

## The effect of ownership structure of corporate governance on agency cost

Y.B. Nhandi<sup>1</sup>, H. Baradaran hasanzade<sup>2</sup>, GH. Sharifzade<sup>3</sup>

1,2Assistant professor in accounting department, Tabriz branch, Islamic Azad University, Tabriz, Iran

3,Msc in accounting, accounting department, Tabriz branch, Islamic Azad University, Tabriz, Iran

Corresponding author :ghafour sharizade; Email: [g.sharify@gmail.com](mailto:g.sharify@gmail.com)

**Abstract:** The main purpose of the development and implementation of corporate governance principles is encourage managers to take steps towards the interests of the company, instead of pursuing personal interests and build confidence among financial market participants. So we can expect that proper development and implementation of the above principles increases the confidence of owners and other interest groups, and ultimately reduces regulatory and agency costs. This study is carried out with the aim of determining the direction and extent of effectiveness of each mechanism of ownership structure corporate governance on agency costs. This study is a causal-post-eventual research in terms of method, and considering its application in capital market is an applied research, in terms of objective. Also test of variables in this study is multivariate regression of panel data. Overall, the results of data analysis of 124 companies listed in Tehran Stock Exchange during the years 1382-1389 shows that the percentage of free floats have a positive effect on agency costs, and the percentage of state ownership, the percentage of directorate ownership and institutional ownership has no effect on agency cost.

[Y.B. Nhandi, H. Baradaran hasanzade, GH. Sharifzade. **The effect of ownership structure of corporate governance on agency cost.** *Life Sci J* 2012;9(4):3002-3010]. (ISSN: 1097-8135). <http://www.lifesciencesite.com>. 441

**Keywords:** ownership structure, corporate governance, agency cost.

### 1. Introduction

Companies and governments have always wanted the opportunity to be in the international financial scene, and do not tend to monopolize their limited local markets in domestic markets. International competition is very essential to make optimal use of the flow of capital transfers throughout the world. Investors' preferences increase with regard to innovations in global financial markets. Parallel to these developments, supervising on common problems an issues facing financial markets is more complex. Due to increased competition by financial markets, countries are required to coordinate their laws with international levels and adopt a set of rules in order to sustain progress which is generated. Empirical studies how that international investors understand the importance of the company's corporate governance procedures on financial performance of those companies more than before, and take their decisions based on that. They believe that this may be more important for companies that need to be amended. Investors are willing to pay more money to invest in countries with good corporate governance. Owen et al. (2004) stated that Corporate governance is an example of regulatory mechanisms for the support of stakeholders, especially shareholders who in the case of bankruptcy will have claim only of the company's remaining value. In competitive markets, managers have an incentive to create more efficient use of the funds at their disposal. Only appropriate corporate governance mechanisms can satisfy such a willing and

consequently improve the performance of the company. Due to factors such as the recent wave of corporate scandals including Adalfia, Enron and World Com in the United States, Carcani in Great Britain and the Royal Auld in the Netherlands, market activists have growing interest in corporate governance. The scandals clearly indicate the need to improve corporate governance and transparency in accounting mechanisms. In this regard, the United States Congress passed new laws such as the Law Sarbanes-Oxley act, more stringent requirements imposed on the companies for entering the Stock Exchange, and Audit committees became more powerful, and internal control systems have been strengthened. The importance of corporate governance practices in improving the quality of financial and accounting information, improving the company's performance, and increasing the company's market value by reducing agency costs is now generally accepted (Elmir et al., 2008). Ownership structure of public limited companies is highly diversified. It seems that the quality of monitoring management activities is different in different companies. Finding effective knowledge of corporate governance system in Iran, and investigating the effect of ownership structure on agency costs are the goals of this research. This means that whether the ownership structure of corporate governance in companies in Tehran stock exchange will have an impact on agency costs? And if yes, to identify the effective factors and to determine the effect of each factor.

## 2. Theoretical Framework:

### Corporate

governance means the processes and structures that has role in conducting and management of commercial activities in a company in order to improve and increase the value of the company. Its ultimate goal is to maximize shareholder value in the long term while the interests of other stakeholders will also be considered. Enlightened theory on shareholders is leading to a new definition for corporate governance. According to the classic definition of Cadbury report, corporate governance comprises "implementing a system for how companies are managed and controlled." This definition can be replaced with a new one: The system consists of all internal mechanisms, which will inform the shareholder of their company's performance and control the company through annual general meetings and the powers delegated to the directorate, while guarantees the company's strategy by adhering to the laws for long-term benefit of the company (Hassas Yaganeh, 1390).

Corporate governance means the processes and structures that has role in conducting and management of commercial activities in a company in order to improve and increase the value of the company. Its ultimate goal is to maximize shareholder value in the long term while the interests of other stakeholders will also be considered. Enlightened theory on shareholders is leading to a new definition for corporate governance. According to the classic definition of Cadbury report, corporate governance comprises "implementing a system for how companies are managed and controlled." This definition can be replaced with a new one: The system consists of all internal mechanisms, which will inform the shareholders of their company's performance and control the company through annual general meetings and the powers delegated to the directorate, while guarantees the company's strategy by adhering to the laws for long-term benefit of the company (Hassas Yaganeh, 1390).

### Research History:

#### Domestic history

Namazi and Kermani (1387) studied the effect of ownership structure on the performance of listed companies in Tehran stock exchange. The findings of 66 companies during 1382 to 1386 prove a negative relationship between institutional ownership and firm performance, and a positive relationship between corporate ownership and performance of the company. Also, management ownership has a negative impact on the performance of the company. In terms of foreign ownership, no information that states ownership of foreign investors in the companies sampled has been observed. Furthermore, on private ownership, it is better to delegate the ownership mainly to the company's investors.

Noravesh et al. (1388) examined the relation between the mechanisms of corporate governance and agency costs of companies listed on the Tehran Stock Exchange. Results from a sample of 88 firms in the years 1382 to 1385 indicate that there is a negative relationship between the ratio of non-required directorate members and the percentage of ownership of institutional investors on the one hand and agency costs on the other hand. However, the results of their research did not match the hypothesis on relationship between corporate debt and agency costs.

Setayesh and Kazemzadeh (1389) examined the effect of ownership structure and directorate composition on dividend policy of firms listed in the Tehran Stock Exchange. Results showed that corporate ownership and directorate independence positively, and institutional ownership negatively affect the dividends of listed companies in Tehran Stock Exchange. However, there were no evidence of a significant relationship between managerial ownership and ownership concentration with dividend policy.

#### 2.1. Foreign History:

Karachi, Jensen, Jahra and Raymond (1999), by studying United States firms in the two three-year period ending in 1987 and 1993, examined the impact of both financial decisions based on debt, institutional ownership, management ownership and dividend policy on the agency costs. The results showed that in the three year period ending in 1993, the influence of institutional ownership has considerably increased. The results also found that in three-year period ending in 1993 the supervision exercised by institutional owners is an appropriate replacement for other mechanisms for controlling agency costs, and reducing the problem of effective agency.

Fleming et al. (2005) in a study carried out on 3800 small and medium sized Australian companies during the years 1996-1997 and 1997-1998, examined the relationship between the ratio of operating expenses to sales, and also the ratio of sale to the properties, as the agency costs on the one hand, and the ownership of directors on the other one, and found that there is an inverse relationship between the two; but the strength of this relationship in Australia was somewhat less than the results found in similar studies in the United States. Furthermore, by testing the level of family governance, found that with the increase in family ownership, the agency costs of the company are reduced.

Florackis (2008) selected a sample of 897 English firms during the years 1999 to 2003 to examine the impact of different mechanisms of corporate governance on the agency cost. He used two factors as representations of agency costs, the ratio of sales to assets and the ratio of operational expenses to sales. His findings include the followings:

Ownership of managers, directorates remuneration, and ownership concentration, can represent a significant relationship with the agency costs. The ratio of borrowing from the banking system to total debts and the ratio of short term debt to total debts, and also the non-required members of the directorate were the mechanisms for reducing agency costs. Effectiveness of Domestic mechanisms of corporate governance on agency costs will vary according to the growth opportunities. For example, the results showed that managers' ownership in companies with high growth is considered as an efficient mechanism to solve the problem of agency.

Samiet al.(2011) evaluated the effect of corporate governance on performance of Chinese (manufacturing) firms. In this study, a combination of criteria is introduced for corporate governance that measures the correlation between corporate governance and firm performance assessment. Because the representation theory is based on the fact that corporate whose governance standards are better act better, they assumed that Chinese companies with better governance have also better performance. The results showed that the provided combined index of corporate governance has a positive relationship with the assessment and performance of the firms.

### 3. The Research Methodology

This study is a positive research of Accounting which is based on the actual data financial statements of companies. Also it is a casual and post eventual and applied research. To test the relationship between the dependent and independent variables the panel regressions is used. Geographic scope of the survey is companies listed in Tehran Stock Exchange in the Islamic Republic of Iran. Time scope of research includes an 8-year period of 1382 to 1389 fiscal years of

the sample firms. The study universe consists of all companies listed on the Tehran Stock Exchange. Of the total universe, 124 companies randomly selected from different industries with the following conditions:

- ✓ Their financial year ended the date 29 Esfand of the year.
- ✓ All their required data were available during the period between the years 1382 to 1389.
- ✓ They were adopted in Tehran Stock Exchange till 1382.
- ✓ They have not been removed from companies listed in Tehran Stock Exchange till 1389.
- ✓ Leasing companies and financial institutions were not included.

Financial statements of above companies are from the Stock Exchange Databases, and their data analysis and testing hypotheses are carried out by Excel, Spss and E\_View software.

#### 3.1. Research Hypotheses:

- ✓ The first hypothesis: the state ownership affects on agency costs.
- ✓ The second hypothesis: the institutional shareholders' ownership affects on agency costs.
- ✓ The third hypothesis: the directorate' ownership affects on agency costs.
- ✓ The fourth hypothesis: the free floats ownership affects on agency costs.

#### 3.2. The research Variables:

The variables of this study and the way they were operationalized are listed in table 1.

Table 1: operational definition of variables

abbreviation	The way variables are operationalized	The label of variables	category
ROE	The ratio of annual sale to total properties	Agency cost	Dependant variable
FCF&Q	<i>FCF-Q Tobin</i>		
GOVOWN	$\frac{\text{capital belonged to the governmental sector}}{\text{total capital of the firm}} * 100$	Percentage of state ownership	Ownership structures (independent variable)
INOWN	$\frac{\text{capital belonged to institutional shareholders}}{\text{total capital of the firm}} * 100$	Percentage of institutional shareholders' ownership	
FREFL	The percentage of free floats published by Tehran Stock Exchange	Percentage of free floating ownership	
BOAOWN	$\frac{\text{capital belonged to the directorate}}{\text{total capital of the firm}} * 100$	Percentage of directorate' ownership	
SIZE	Natural logarithm for the firm's market value	Firm size	Control variables
FL	Total properties/total debts	Financial leverage	

#### 3.3. Agency Cost:

In this study, two methods of efficiency ratio and interaction between free cash flow and growth opportunities are used to measure the agency costs.

1 -Efficiencyratio: indicates thecriteria formanagers' efficiency in the firms which is derived from thefinancial statements.

1-1assetturnover ratio: indicates theratioofannual salestototalassets, and measures theproductivityand use of the company's assetsbymanagers in order to createmoresales.This ratiois used as aninversemeasure ofagency costs.Inthis studyto measure theagency cost, theassetturnover ratiois usedas an indexrepresenting theinverse of agency costs.

2 - Interaction between free cash flow and growth opportunities: Jensen in his free cash flow theory states thatmanagers tend to reinvest free cash flows in their companies instead of distributing them between owners, since payments to shareholders reduce the resources under control of managers, and thus their power is reduced.This is also probably due to the need to attract new capital by the Company, which will increase supervision of the capital market. In other words,accumulation of free cash flow can reduce the market surveillance on decisions taken by managers. Managers tend to firm's growth more than its optimum size. Since the firm's growthwill increase resources controlled by the company managers, and will increase the power and reward of the managers. Given the different goals of owners andmanagers, the cash flows generated by the Company in excess of the cash which is required for financing new projects with positive net present value, leads to the net present investment of these amounts in the project which have a negative current net value, which in turn willresult in the potential loss of these resources. As a result, firms with high growth opportunities and low cash free flows have high agency costs.

**3.4. Descriptive statistics:**

The descriptive statistics related to the research variables are listed in table 2. Considering the resulting values, it can be said that the firm size has the lowest coefficient of variation, and therefore is the most stable variable during the period of 8 years, and financial leverage variable has the highest coefficient of variation, and therefore is the least stable during the period of 8 years among all variables. The results show that all variables studied, including independent, dependent and control variables have a normal distribution according to statistics Jark–Bra statistics, since their significance level was more than 5%.

Table 2. Descriptive statistics

Financial leverage	Firm size	Percentage of free floats	Percentage of state ownership	Percentage of directorate's ownership	Percentage of institutional shareholders' ownership	Performance ratio	Growth opportunities and cash flow		
7	0.19	5.477	24.788	32.119	62.750	61.816	1.889	0.745	mean
8	0.14	5.420	25.000	0.05	64.300	70.910	1.420	0.680	median
7	0.72	7.820	90.000	88.000	99.200	98.210	10.540	2.580	maximum
6	0.00	3.980	5.000	0.001	1.080	0.001	0.340	0.050	minimum
5	0.15	0.592	14.791	23.451	16.945	25.012	1.471	0.377	Standard deviation
5	0.78	0.108	0.596	0.730	0.270	0.404	0.779	0.505	Change coefficient
937	253.	186.322	231.511	468.587	68.923	183.169	818.470	1039.111	Jark - Bra
07	0.13	0.0817	0.176	0.112	0.101	0.0596	0.177	0.154	significance level
363	196.	5433.42	24590	31853	62248	61321.8	1874.25	739.59	total
	992	992	992	992	992	992	992	992	Number of observations

**3.5. Selecting an Appropriate Pattern for Regression Models**

Since at present there are two dependent variables in this research, a separate model is represented for each. So choosing the right model, the Limer test was performed for each of the following models, which is provided in the table below.

First model:

$$ATO_{i,t} = c + B_4GOVOWN_{i,t} + B_5BOAOWN_{i,t} + B_6INOWN_{i,t} + B_7FREFL_{i,t} + B_8SIZE_{i,t} + B_9FL_{i,t} + \epsilon_{i,t}$$

Second model:

$$FCFQ_{i,t} = c + B_4GOVOWN_{i,t} + B_5BOAOWN_{i,t} + B_6INOWN_{i,t} + B_7FREFL_{i,t} + B_8SIZE_{i,t} + B_9FL_{i,t} + \epsilon_{i,t}$$

Table 3. The results of Limer F test:

Probability	statistic	Degrees of freedom	test	model
				first
0.000	4.478	(123,859)	Limer F	
0.000	491.523	123	Chi-Score	
				second
0.000	11.951	(123,859)	Limer F	
0.000	989.46	123	Chi-Score	

As shown in the above table, the P.value value for F Limer and Chi score has the significance level of less than 5%. Therefore, it can be said that panel data methods should be used to test the research hypotheses. In the following, we use Hausman test in order to select different modes of panel method. Results are shown in Table (4).

Table 4: the results of Hausman test:

Probability	Chi Score statistic	Degrees of freedom	test	Model
				first
0.0001	49.321	9	Hausman	
				second
0.9895	2.115	9	Hausman	

Considering the values obtained, since P. value of Hausman testing for the first model (ATO<sub>i,t</sub>) is less than the significance level of 5%, therefore, here is sufficient reason to reject the fixed effects model, and to test related hypotheses, the fixed effects model is used. Due to the fact that P. value values of Hausman test for the second model (FCFQ<sub>i,t</sub>) is greater than the significance level of 5%, therefore, using a random effects model is better than using a fixed effects model, and to test related hypotheses, a random effects model is used.

**3.6. Testing the research's hypotheses:**

**The research's general hypothesis:**

H<sub>0</sub>: Ownership structures of corporate governance do not affect on agency costs.

H<sub>1</sub>: Ownership structures of corporate governance affect on agency costs.

Statistical hypothesis statement:

To investigate this hypothesis, agency cost is quantified by two different variables, and test with the model presented below.

$$AGENCYCost_{i,t} = c + B_1CG_{i,t} + B_2SIZE_{i,t} + B_3FL_{i,t} + \epsilon_{i,t}$$

First hypothesis: the state ownership affect on agency costs.

H<sub>0</sub>: the state ownership has no effect on agency costs.

H<sub>1</sub>: the state ownership affect on agency costs.

The results of the regression model using generalized least squares GLS are presented in Tables 5. With regard to the fact that significance level of first hypothesis test is 0.64 and greater than 0.50 (acceptable error level), the first research's hypothesis is rejected. In other words, the effect of state ownership on agency costs (efficiency ratio) is not statistically significant.

Table 5 . 1. the results of testing the first research's hypothesis

The dependant variable: agency cost (efficiency ratio)				
Significance level	T statistic	Standard deviation	coefficients	variable
0.641	0.465	0.009	0.0043	State ownership
0.168	1.37	0.0307	0.042	Firm size
0.001	-0.522	0.067	-0.354	Financial leverage
10.99	F statistic	0.032		Coefficient of determination
0.0001	Significance level	0.029		<b>Modified coefficient of determination</b>
	1/52	Durbin - Watson statistic		



With regard to the fact that significance level of first hypothesis is 0.939 and greater than 0.50 (acceptable error level), the first research's hypothesis is rejected. In other words, the effect of state ownership on agency costs (interaction of growth opportunities) is not statistically significant.

Table 5 . 2. the results of testing the first research's hypothesis

The dependant variable: agency cost (interaction between growth opportunity and cash flows)				
Significance level	T statistic	Standard deviation	coefficients	variable
0.939	0.076	0.003	-0.002	State ownership
0.001	-3.17	0.118	-0.46	Firm size
0.011	-1.68	0.318	-0.536	Financial leverage
5.567	F statistic		0.16	Coefficient of determination
0.0001	Significance level		0.13	<b>Modified coefficient of determination</b>
		1.48	Durbin - Watson statistic	

The modified coefficient of determination indicates that in the whole research period approximately 03% of the variations in total costs (efficiency ratio) and approximately 13% of the variations in total costs (interaction between opportunities and free cash flow) is explained by the variables. The results of the F statistic with the probability of (0.001) indicates that these models in general were considered statistically significant, and according to Durbin-Watson statistics, do not have a serious self-association problem.

**3.7. The Second Hypothesis: the institutional ownership affects on agency costs.**

Statistical hypothesis statement:

H0: Institutional ownership does not affect the agency costs.

H1: Institutional ownership affects the agency costs.

The results of the regression model using generalized least squares GLS are presented in Tables 6. With regard to the fact that significance level of the second hypothesis is 0.36 and greater than 0.05 (acceptable error level), the second research's hypothesis is rejected. In other words, the effect of institutional ownership on agency costs (efficiency ratio) is not statistically significant.

Table 6 . 1. The results of testing the second research's hypotheses

The dependant variable: agency cost (efficiency ratio)				
Significance level	T statistic	Standard deviation	coefficients	variable
0.361	-0.91411	0.002011	-0.001838	institutional ownership
0.0001	-12.12215	0.071427	-0.86585	Firm size
0.0027	-3.007951	0.112386	-0.338052	Financial leverage
8.256	F statistic		0.41	Coefficient of determination
0.0001	Significance level		0.27	<b>Modified coefficient of determination</b>
		1/55	Durbin - Watson statistic	

With regard to the fact that significance level of the second hypothesis is 0.35 and greater than 0.05 (acceptable error level), the second research's hypothesis is rejected. In other words, the effect of institutional ownership on agency costs (interaction of growth opportunities) is not statistically significant.

Table 6 . 2. The results of testing the second research's hypotheses

The dependant variable: agency cost (interaction between growth opportunity and cash flows)				
Significance level	T statistic	Standard deviation	coefficients	variable
0.351	-0.000707	0.000757	-0.934168	institutional ownership
0.142	0.045275	0.03083	1.468543	Firm size
0.0001	-0.350568	0.067684	-5.179513	Financial leverage
11.22	F statistic		0.03	Coefficient of determination
0.0001	Significance level		0.03	<b>Modified coefficient of determination</b>
		1.55	Durbin - Watson statistic	

The modified coefficient of determination indicates that in the whole research period approximately 27% of the variations in total costs (efficiency ratio) and approximately 3% of the variations in total costs (interaction between opportunities and free cash flow) is explained by the variables. The results of the F statistic with the probability of (0.001) indicate that these models in general were considered statistically significant, and according to Durbin-Watson statistics, do not have a serious self-association problem.

**3.8. The third hypothesis: the directorate's ownership affects the agency costs.**

Statistical hypothesis statement:

H<sub>0</sub>: the directorate's ownership does not affect the agency costs.

H<sub>1</sub>: the directorate's ownership affects the agency costs.

The results of the regression model using generalized least squares GLS are presented in Tables 7. With regard to the fact that significance level of the third hypothesis is 0.29 and greater than 0.05 (acceptable error level), the third research's hypothesis is rejected. In other words, the effect of directorate's ownership on agency costs (efficiency ratio) is not statistically significant.

Table 7. 1. Results of testing the third research's hypothesis

The dependant variable: agency cost (efficiency ratio)				
Significance level	T statistic	Standard deviation	coefficients	variable
0.294	-1.04994	0.001819	-0.00191	Directorate's ownership
0.0001	-12.24258	0.06947	-0.850496	Firm size
0.0012	-3.25318	0.10821	-0.352025	Financial leverage
8.47	Statistic F		0.45	Coefficient of determination
0.0001	Significance level		0.38	<b>Modified coefficient of determination</b>
		1.56	Durbin - Watson statistic	

With regard to the fact that significance level of the third hypothesis is 0.74 and greater than 0.05 (acceptable error level), the third research's hypothesis is rejected. In other words, the effect of directorate's ownership on agency costs (interaction of growth opportunities) is not statistically significant.

Table 7. 2. Results of testing the third research's hypothesis

The dependant variable: agency cost (interaction between growth opportunity and cash flows)				
Significance level	T statistic	Standard deviation	coefficients	variable
0.7467	-0.323076	0.000974	-0.000315	Directorate's ownership
0.1658	1.386854	0.030732	0.042621	Firm size
0.0001	-5.21864	0.067715	-0.35338	Financial leverage
10.91	Statistic F		0.03	Coefficient of determination
0.0001	Significance level		0.03	<b>Modified coefficient of determination</b>
		1.53	Durbin - Watson statistic	

The modified coefficient of determination indicates that in the whole research period approximately 38% of the variations in total costs (efficiency ratio) and approximately 3% of the variations in total costs (interaction between opportunities and free cash flow) is explained by the variables. The results of the F statistic with the probability of (0.001) indicate that these models in general were considered statistically significant, and according to Durbin-Watson statistics, do not have a serious self-association problem.

**3.9. The fourth hypothesis: the free floats affect the agency costs.**

Statistical hypothesis statement:

H<sub>0</sub>: the free floats ownership does not affect the agency costs.

H<sub>1</sub>: the free floats ownership affects the agency costs.

The results of the regression model using generalized least squares GLS are presented in Tables 8. With regard to the fact that significance level of the fourth hypothesis is 0.017 and less than 0.05 (acceptable error level), the fourth research's hypothesis is approved. In other words, the effect of free floats ownership on agency costs (efficiency ratio) is statistically significant, and this effect is direct one.

The dependant variable: agency cost (interaction between growth opportunity and cash flows)				
Significance level	T statistic	Standard deviation	coefficients	variable
0.395	-0.849427	0.001532	-0.001301	Free floats ownership
0.173	1.36205	0.030725	0.041849	Firm size
0.0001	-5.246876	0.067756	-0.355508	Financial leverage
10.89	statisticF		0.03	Coefficient of determination
0.0001	Significance level		0.03	<b>Modified coefficient of determination</b>
1.73			Durbin - Watson statistic	

Table 8. 1. Results of testing the fourth hypothesis

The dependant variable: agency cost (efficiency ratio)				
Significance level	T statistic	Standard deviation	coefficients	variable
0.017	1.359746	0.003219	-0.004378	Free floats ownership
0.001	-12.34657	0.068377	-0.844221	Firm size
0.001	-3.206093	0.106232	-0.340589	Financial leverage
0.001	16.68466	0.387917	6.472266	The intercept
8.57	statisticF		0.42	Coefficient of determination
0.0001	Significance level		0.38	<b>Modified coefficient of determination</b>
1.76			Durbin - Watson statistic	

With regard to the fact that significance level of the fourth hypothesis test is 0.395 and greater than 0.05 (acceptable error level), the fourth research hypothesis is rejected. In other words, the effect of free floats ownership on agency costs (interaction of growth opportunities) is not statistically significant.

The modified coefficient of determination indicates that in the whole research period approximately 3% of the variations in total costs (efficiency ratio) and approximately 3% of the variations in total costs (interaction between opportunities and free cash flow) is explained by the variables. The results of the F statistic with the probability of (0.001) indicate that these models in general were considered statistically significant, and according to Durbin-Watson statistics, do not have a serious self-association problem.

Table 8. 2. Results of testing the fourth hypothesis

The results of testing hypothesis	The hypothesis text	Table 9 summary of the testing results
rejected	State ownership affects the agency costs.	1
rejected	Institutional ownership affects the agency costs.	2
rejected	Directorate's ownership affects the agency costs.	3
approved	Free floats ownership affects the agency costs.	4

#### 4. Discussions

The first hypothesis tested in this study suggests that state ownership has no effect on agency costs, while from a theoretical point of view, privatization and reduction in state ownership leads to increased number of shareholders and the necessity of the separation of ownership and management and agency problem, so that companies are controlled by majority shareholders, and there is potential for their abuse of the rights of minority shareholders. These two problems make designing and modifying the appropriate mechanism to protect shareholders against managers (problem representation) and the rights of all stakeholders necessary. The second hypothesis suggests that the effect of institutional ownership on agency costs is not a significant one, while from the theoretical perspective, supervision exercised by institutional owners reduces the agency cost (Karachi, 1999; Noravesh et al, 1388). The third hypothesis tested in

this study suggests that Directorate's ownership does not affect the agency costs, while from the theoretical perspective, increased directorate's ownership makes the directorate members to participate in the profits and losses of the company more, and then reduces the agency cost (Lukas et al, 2011; Bake, Jensen and Kim, 2009). Perhaps the reason for this result is that the corporate governance mechanisms affect the agency costs together not alone (Bojan et al, 2006). Test results for the fourth hypothesis indicate that the percentage of free floats affects the agency costs in a positive way. It means increasing the free floats percentage will increase the firms' agency costs. Based on current theoretical resources, existence of major investors reduce agency costs, because managers tend to take a step in the interests of shareholders increasingly, and consequently, cheating in financial reporting through the manipulation of accounting profits will be reduced dramatically.

Roy Kouwenberg(2006) argues that the most effective way to ensure proper management of a company in emerging markets may be the ownership concentration. Therefore, these results are consistent with existing theories.

#### 5. Research limitations:

One of the major problems in this study was lack of corporate governance rating agencies that provide grants to companies. We hope that the economic growth and development of the capital market in Iran create such organizations even in a limited number, for the future research.

#### 6. Applied suggestions:

According to the results, and to determine the impact of free floats on the agency costs, it can be said that the companies listed on the Stock Exchange take further regulatory measures (such as information disclosure) in their agenda in order to reduce agency costs, in agencies that have a high percentage of free floats. Also the Stock Exchange, by considering these results and enacting the related rules and taking preventive measures to avoid conflicts of interest between owners and managers, can help to improve the organization's overall trend and process of these companies, to align the interests of different stakeholder groups.

#### References:

1. Hassas Yeganeh, Y., Hasani, M., and Kashanian Sh (1390), Whose interests are provided by the corporate governance? The accountant journal, vol. 218, pp. 94 – 97.
- 2- Noravesh, I., Karami, Gh., and Vafi Sani, J. (1388) examining the relationship between the mechanisms for firm governance systems and agency costs of firms listed in Tehran Stock Exchange, accounting researches journal, vol. 1, pp. 4 – 27.
- 3- Namzai, M., and Karimi, E. (1387) the effect of ownership structure on performance of firms listed in stock exchange, accounting and auditing examinations journal, vol. 53, pp. 83 – 100.
- 4- El Mir, a., & Seboui, s., 2008. Corporate governance and the relationship between EVA and created shareholder value. **Corporate Governance**, 8, 46-58
- 5- Fleming, G. R. Hcaney and R. McCosker (2005) Agency costs and ownership structures in Australia” **pacific- Basin finance Journal** .13 : 29-52
- 6- Florackis. c. (2008).”Agency costs and corporate governance mechanisms: Evidence for UK firms”. **International journal of managerial finance** 4, 37-59
- 7- Lukas Setia-Atmaja, Janto Haman (2011) George Tanewski The role of board independence in mitigating agency problem II in **Australian family firms** journal homepage: [www.elsevier.com/locate/](http://www.elsevier.com/locate/)
- 8- Roy, Kouwenberg. (2006). **Does voluntary corporate governance code adoption increase firm value in Emerging Markets?** Evidence from Thailand. Research paper, Mahidol University, College of Management.

9/6/2012

## Political Structure and Administrative System of Poshtkooch (Ilam) In the period of Valian

Ebrahim Yaghobi<sup>1</sup>, Sivash Yari<sup>2</sup>

<sup>1</sup>Permanent Member of Iran Historic Society, Author and Researcher, Ilam University Instructor, Education Organization

<sup>2</sup>Faculty member Ilam University, Ilam, Iran  
Yaghobi6@yahoo.com, Cia839@yahoo.com

**Abstract:** Hassan Khan was appointed as governor of Lorestan from 1215 to 1255 AH according to Valian historical writings in Takht Khan remained from Agha Mohammad Khan Qajar Era. Hasan Khan ruled Poshtkooch area until age 90. After death of Agha Mohammad Khan, his successor Fath Ali Shah undertook to limit the influence of local and border area governors and rulers in order to strengthen his own reign and achieve his designated objectives. He appointed Qajar governors to those areas he considered problematic for his rule in an attempt to bring Iran in complete control of Qajar rule. He appointed his able son, Mohammad Ali Mirza Dolatshah, to governorship of Kordestan and Kermanshah. Lorestan was divided into two areas called Pishkooch and Poshtkooch. Poshtkooch was a border area and subject to continuous disputes between Iran and Ottoman. Dispute arose between Hassan Khan and his sons, Ali Khan, Ahmad Khan, and Heidar Khan at the end of Hassan Khan's life. The result of this dispute was the division of Poshtkooch into three areas between Hassan Khan's three sons. Mohammad Ali Mirza Dolatshah took advantage of the family dispute to weaken Hassan Khan Vali. He managed to increase its sphere of influence by interfering and supporting sons against father. It is believed that Hassan Khan Vali did not show his loyalty to Fath Ali Shah and reigned as an independent ruler. His independence forced the central government to weaken his position by conspiring and encouraging family disputes. Hassan Khan Vali was one of the servants to Shahverdi Khan, the last ruler of Atabakan of Lorestan. He died at age 90 in 1255 AH during Fath Ali Shah era. He was buried in Keshik Khaneh, in Najaf Ashraf. Vali Heidar Khan ruled Poshtkooch from 1255 to 1273 AH. His reign was supported by the central government. Hussein Gholi became Poshtkooch governor after the death of Haidar Khan. Hussein Gholi Khan earned several titles including Sarem al-Saltaneh, Sardar Ashraf, and Amir Tooman. Qajar historiographers and foreign reporters, including travelers and adventurers who had traveled to Poshtkooch during Nasser al-Din Shah Era and later, had explicitly written about Hussein Gholi Khan's bravery, heroism, and authority. He earned the title of Aboo Ghaddareh for his harsh suppression of rebellious and unruly Seqvand tribes, who had looted Dezfool, and his continued conflict with Bani Lam Arabs, who were Ottoman citizens and crossed borders in aggression. After death of Hussein Gholi Khan, his son Gholam Reza Khan became Vali. He had received Fath al-Sultan title after his father's suppression of rebellious tribes. He later took the title of Sarem al-Sultan. Gholam Reza took his money and jewelry, moved to Iraq, and settled in Bagdad during Reza Shah Pahlavi era. Gholam Reza moiled over returning to Iran in 1308. He was even granted respite. However, Gholam Reza Khan changed his mind about returning after Anvar Lorestan chiefs were hanged in Khorram Abad by Major General Agha Khan Khazaiee upon their return to Iran in spite of respite granted by Iranian authorities with a pledge not to be harmed. [Ebrahim Yaghobi, Sivash Yari. **Political Structure and Administrative System of Poshtkooch (Ilam) the period of Valian** . *Life Sci J* 2012;9(4):3011-3019] (ISSN:1097-8135). <http://www.lifesciencesite.com>. 442

**Keywords:** Poshtkooch Valian, Valigari, Hassan Khan, Heidar Khan, Hussein Khan, Aboo Ghadareh, Gholam Reza Khan

### Introduction

The word Vali means Governor. This term was first used in Safavid Era. It was the highest ranking position for tribes who lived in the border areas in that time. There were at most 4 Valis in the country. They were old khans who had inherited the governorship. These Khans ruled under Safavid Government, yet, they kept a degree of independence. The taxes collected by Valis were not reflected in the central government's budget. Nevertheless, they passed a part of their collections to the central government in the form of gifts and presents to King. In fact, they helped King with their payments (Alirezaiee, 1380, p. 28).

George Curzan had this to write about Vali governorship: "Governorship or Vali is a position which is sold in Iran similar to any other state job or position. The position is given to anyone who offers to pay the highest. The measurement ordinary used for valuation is based on the generating potential or causes of earning depletion of the area (Curzan, 1365, p. 250).

According to many studies conducted by researchers and scholars on the subject, Lorestan Valian (Poshtkooch and Pishkooch) were descendants of Rabieh Arabs who lived near Baghdad. They moved toward Iranian border as the result of tribal conflicts and infightings. One of them by the name of Zahir

emigrated from Iraq into Lorestan. His bravery and abilities earned him fame and Mohammadi, Ataback of Lorestan, took a special liking of him.

After Zahir's death, his son by the name of Mansour became close to Governor and married Shahverdi Khan's aunt. A son was born from this marriage named Hussein Khan. He was recognized because of his ingenuity and cleverness. Hussein Khan took over governorship after Shahverdi Khan's murder. He later founded Valian of Lorestan (Saki, no date, pp. 288-289).

Poshtkooh of Lorestan is an area with many rivers. Three fourth of Poshtkooh rivers pour into huge Seimareh River, which enters into sea. People who lived in Poshtkooh never left their settlement area. They lived so far away from Tehran that certain areas of Lorestan did not use currency for their trade. They used barter similar to their ancestors. They engaged in animal husbandry for living. The average life span for male and female was one hundred years. There were some men and women who had hundred fifty years of age. Poshtkooh area was so difficult to pass that no conqueror from East or West had ever passed through the area. Many Lor tribes lived in Poshtkooh. Each tribe had one chief. The tribe chiefs followed one who was considered as the alderman (Afshar Sistani, 1366, p. 721).

Hassan Khan or Mohammad Hassan Khan was son of Ismail Khan. Valian of Poshtkooh ruled in Khorram Abad until the time of Ismail Khan. They used Falakol Aflak Fort as their center. Vali Mohammad Hassan Khan moved his administration from Khorram Abad to Poshtkooh by the order of central government when border conflicts broke up between Iran and Ottoman. Poshtkooh was closer to the border line and Hassan Khan was charged to stop Ottoman's continued intrusions and interferences. Poshtkooh Valian reigned in Lorestan and Poshtkooh for 334 years from Hassan Khan to Gholam Reza Khan (Bamdad, 1378, p. 88).

Hassan Khan, Haidar Khan, Hussein Gholi Khan Aboo Ghadareh, and Gholam Reza Khan became Poshtkooh Valies one after the other. They did not rule Lorestan but their influence on Lorestan remained strong till the early Pahlavi Era when the last Vali fled to Iraq. Their influence was through maintaining relationship with Lorestan tribes and use of the winter pastures they utilized in Poshtkooh areas neighboring Lorestan like Biravand.

#### **Line of Ancestry Based on Pedigree**

Valian family possessed a pedigree which is subject of debate because of its content and author. The name of Mohammad Jafar ibn Mohammad Ali Nasabeh appears At the bottom of pedigree. He was a genealogist of Qajar Era. The preparation date of this pedigree was written on the bottom as 1245 AH. It

was during Hassan Khan reign who was Vali at the time till 1255 AH. Hussein Khan had ruled Poshtkooh for 30 years when pedigree was prepared. Mohammad Jafar Nasabeh noted on the pedigree that the original one was in the verge of destruction when he wrote the new one (Chaman Ara, 1383, p. 32).

Mohammad Jafar Nasabeh traced Hassan Khan's ancestors to Hazrat Abolfazl al Abass, son of Hazrat Ali ibn Abitaleb, after going back 23 generations. He further traced back the pedigree from Om al Banin, Hazrat Abolfazl's mother, to Ghasi ibn Kallab.

Let's assume that the ancestry of Hassan Khan up to the last Vali were to go back after 26 generations to Hazrat Abolfazl al Abass. If the time between birth, getting married, and having the first child to be 30 years per generation, then, 26 generations times 30 years become 720 years. If the final year of the last Vali was 1340 AH and we deduct 720 years from it, we get back to 620 AH. That was around the period when Moguls conquered Iran. Hazrat Abolfazl al Abass was murdered in Karbala in 61 AH. The deference between the year of his murder and 620 AH is 550 years. If pedigree were to go back as far as Hazrat Abolfazl al Abass, we would need another 18 generations.

In Agha Mohammad Khan period, Lorestan included Poshtkooh and Pishkooh. Presently, Poshtkooh is in Lorestan and Pishkooh is in Ilam (Khoda Bakhshi, 1384, p. 26). Kabirkooch divides the area into two parts, namely, Poshtkooh and Pishkooh. The West and South parts are Poshtkooh, while the Eastern part which includes parts of West Lorestan is known as Pishkooh. The hilly parts of the latter overlooks Bein al-Nahrain plain field. In Historical Geography of Cities, it was mentioned that Kabirkooch divided Little Lor or present Lorestan into two areas called Poshtkooh and Pishkooh (Mahmoodian, 1377, p. 9).

Valian family ruled the whole area of Little Lorestan from 1596 AD/976 to 1796 AD/1175. Agha Mohammad Khan who was the founder of Qajar decided in 1796 AD to separate Poshtkooh from Lorestan in an attempt to weaken Valis' power and reduce their sphere of influence on the area (Mortenes, 1377, p. 70).

Lorestan Valis ruled the area for a long time including Poshtkooh and Pishkooh. Fath Ali Shah Qajar divided Lorestan into two area, namely Poshtkooh (Ilam) and Pishkooh (Lorestan) during Hassan Khan's reign (Mohammad Khan's son). Consequently, Valis' area of power became limited to Poshtkooh. Valian chose Khorram Abad as their capital and still spread their influence into Ilam Province. The center of Poshtkooh Valian was later moved to "Deh Bala" or "Divala" (Alirezaiee, 1380, p. 31). Valian moved out of Khorram Abad and settled

with part of their tribes in Poshtkooch in 1796 AD/1175 (Mortens, 1377, p. 70).

Valian power was weakened when Hassan Khan Vali was forced to move his administration to Poshtkooch by the order of Qajar King. This move engaged him with Poshtkooch tribal chiefs and started flame of conflicts with them.

Ismaeel Khan Vali, who was forefather of Hassan Khan Vali, had three sons by the names of Asad Khan, Mohammad Khan, and Kalbali Khan. Ismaeel Khan suffered from physical and sight weaknesses due to old age at the end of his life, therefore, could not personally attend to his government. Poshtkooch administrator started cruelty and abuse to the extent that Poshtkooch tribal chiefs decided to intervene and stop his further aggression. Their intervention ended with his elimination and murder (Saki, No date, p. 321).

### **Poshtkooch Valian**

#### **1- Vali Hassan Khan (1215 AH to 1255 AH)**

Hassan Khan took over after Mohammad Khan passed away and Ismaeel Khan retreated into solitude. Ismaeel Khan had recommended to Hassan Khan to take revenge for Mohammad Khan's murder. Hassan Khan ruled Lorestan and Poshtkooch for several years. His revenge of Lorestan tribal chiefs made him a detested ruler. He was forced to move from Khoram Abbad to Deh Bala, present Ilam, by the order of Qajar government. Thus, his ruling became confined to that area. Hassan Khan's movement took place in 1216 AH. Earlier, he had undertaken to murder Lorestan tribal chiefs in revenge of Mohammad Khan's murder. Saki has this to write about the incident: Hassan Khan took over the administration as Assad Khan's successor by approval from Qajar king.

Tribal chiefs who were involved in Mohammad Khan's murder felt repentant for their act. They sent Abdol Hussein Khan to Vali for mediation. He was the forefather of the present Karam Ali family. He was an eloquent speaker and was charged to ask Hassan Khan to accept tribal chief for an opportunity to offer their apology in person. Hassan Khan accepted to meet them and offered them respite. However, had them beheaded when they arrived (Saki, No date, p. 321).

Hassan Khan went to Lorestan in the same year to help governors of Broojerd and Seilakhor to stop Hussein Gholi Khan, the rebellious brother of Fath Ali Shah, from escaping to Ottoman. After capture of Hussein Gholi Khan, Hassan Khan murdered certain Lorestan chiefs, especially Biranvand tribal chiefs, for supporting Hussein Gholi Khan. His act was intended to take revenge and created an increased hatred among Lorestan people toward him.

Earlier, he had captured Mohammad Khan Zand who had recruited fighters in Lorestan for a while. He

blinded Mohammad Khan Zand after capture and sent back to Fath Ali Shah. He fought along with Mohammad Ali Mirza Dolatshah in a conflict with Ottoman. He participated in capturing Soleimanieh.

Ilam elders tell stories about mass murder of Poshtkooch tribal chiefs. These stories remain unconfirmed. Hassan Khan never trusted Lorestan and Poshtkooch tribes. He always undertook to destroy or frustrate them (Rad, 1374, p. 377).

Agha Mohammad Khan maintained a friendly relationship with Lorestan Vali at the beginning of Qajar Dynasty. Agha Mohammad Khan never adopted a plan to topple Valian reign. However, Fath Ali Shah adopted an overall policy to install Qajar governors throughout the county. This policy was intended to reduce the power exercised by local governors and prevent their rebellion (Rahimi, 1383, p. 11).

The outcome of Fath Ali Shah policy was evident in many areas of Iran. One instance was the limitation imposed on Valian authority to restrict them to Poshtkooch area. Fath Ali Shah appointed his brave son, Mohammad Ali Mirza Dolatshah, to governorship of Western areas of Country. Mohammad Ali Mirza managed to mend the sour relationship that existed between Hassan Khan, Poshtkooch Vali, and his father, Fath Ali Shah.

Valis always supported the central government especially during military campaigns conducted by Mohammad Ali Dolatshah against Ottomans. Hassan Khan Vali grew dissatisfied when Fath Ali Shah reduced his territory and made him move to Poshtkooch.

When Mohammad Ali Dolatshah fell ill, Vali Hassan Khan became uneasy and feared for his life on threats from Fath Ali Shah. That was the reason Mohammad Ali Dolatshah permitted Hassan Khan to return to Poshtkooch before his death. (Etemad al Saltaneh, 1364, p. 1549).

After Hassan Khan Vali passed away, Fath Ali Shah tried to incite dispute between his sons to make area seem unsafe so that he could intervene more often on the pretext to secure the area by forces of the central government. Fath Ali Shah's policy limited Valian's grip on power. His policy continued till the time Hussein Gholi Khan Aboo Ghadareh came to power. This was the time the relation between Shah and Vali improved.

Vafa Zel al-Sultan attracted attention and favor from Shah for his invaluable contributions in suppressing rebellious tribes and nomads (Zel al-Sultan, 1362, p. 182). As old folks recalled, he managed to disperse or destroy old and original tribes in Poshtkooch such as Rizeh Vandi and Soreh Miree. The remains of Rizeh Vandi tribe was dispersed in

three provinces or mixed with other tribes (Saraiee, 1379, p. 67).

The search for documents about this period (Hassan Khan era) led to the writings from Poet of Foggy Pinnacles, which is interesting to mention here: "In speaking to the old members of Deh Bala tribe it was discovered that Zangeneh tribe sold North East mountain areas of Ilam to Deh Bala tribe. The name of Gholam Reza Arkavazi and other tribal chiefs were mentioned as witness to this sale. The date on the title indicates that it is a copy of an original document, which puts the authenticity of the document in doubt. The year of the date appears to be 11106. It could be either 1116 or 1106. The favorable statement issued by Hassan Khan to Gholam Reza Arkavazi was dated 1219. Therefore, the date could be either 1206 or 1216. Given the fact that Hassan Khan entered Poshtkooch in 1216, the latter date seems more appropriate. This gives rise to another possibility. Zangeneh Tribes may have sold their pastures and left Poshtkooch for Kermanshah at the time Hassan Khan arrived in the area.

Hassan Khan brought many individuals to Poshtkooch as clerk, writer, judge, apprentice, servants, and retainers. Other tribes also moved from Lorestan and settled in Poshtkooch. Successors of these individuals still live in Ilam and have adapted to the new cultural setting.

Hassan Khan administration had terrible jails. Strict and rough officials made life difficult for people. It did not seem that he had attempted to provide wellbeing and progress to Poshtkooch area (Saraiee, 1379, p. 67).

Rowlinson wrote about Hassan Khan and his reign: "Poshtkooch is still ruled by Vali. Hassan Khan Vali made a superficial agreement with the central government after Mohammad Ali Mirza Dolatshah passed away in order to strengthen his power (Aman al-Lahi, 1362, p. 52).

A minor dispute accrued between Hassan Khan and his elder sons before I met them. Tribes had taken sides with one of them. Kermanshah government took advantage of situation and started to intervene by backing up the two sons against the father. This intervention had helped the local government to gain minor influence in the area. Hassan Khan was dismissed and his sons, Ali Khan, Heidar Khan, and Ahmad Khan were collectively selected as Valis for the area.

Tribes found out that they were venerable when conflicts aroused among rulers and influence of central government increased. Therefore, they mediated peace between father and sons. Hassan Khan now rules Poshtkooch like a powerful, capable, and independent prince (Saraiee, 1379, p. 68)".

## 2- Heidar Khan Vali (1255 AH to 1273 AH)

After Hassan Khan's death, his sons, Ali Khan, Heidar Khan, and Ahmad Khan divided Poshtkooch between themselves (Afshar Sistani, 1372, p. 156). Qajar government recognized Heidar Khan as Vali of Poshtkooch. In Takht Khan engraving, Heidar Khan and his brothers are not honored. Their names did not even appear in the pedigree discussed earlier (Karimi, 1372, p. 70).

After Heidar Khan passed away in 1273 AH, his son Hussein Gholi Khan was appointed as Poshtkooch governor by Nasser al Din Shah. He was an outstanding Vali. According to the records of traveling journalists, Hussein Gholi Khan was cruel, blood thirsty, fastidious, and persnickety. He suppressed rebellious Arab tribes living in Khoozestan together with Lorestan unruly tribes. He stopped border intrusions by Ottoman. Central government raised his position to Amir Tooman or General. He also earned titles such as Sarem al-Saltaneh, Sardar Ashraf, and Aboo Ghaddareh. The latter title remained in Vali family. It is still a family name of some of their successors (Afshar Sistani, 1372, p. 157).

Hussein Gholi Khan changed the name of the seat of his government from "Deh Bala" to "Hussein Abad" or "Husseinieh". He built a cubic fort there and formed an army of 700 cavalry and 2000 infantry. The number could increase to thousands when necessary (Ibid, 1372, p. 157).

Hussein Gholi Khan tribe was not nomad like other Valis' tribes. His entourage was so large to fill a city. They moved wherever Khan moved to. DeMorgan, Lord Curzan, and Haj Sayyah Mahallati, all met him. They wrote about him and readers who are interested in their description can refer to their books.

## 3- Hussein Gholi Khan (1273 AH to 1318 AH)

Hussein Gholi Khan Aboo Ghaddareh was son of Heidar Khan and grandson of Hassan Khan. He carried titles such as Sarem al-Saltaneh and Sardar Ashraf as Poshtkooch Vali. Poshtkooch valians were successors of Hussein Khan, the first Lorestan Vali. Hussein Khan was a servant of Shahverdi Khan, the last member of Atabakan of Lorestan. Shahverdi Khan rebelled against Great Shah Abbas. He escaped to Jangaleh, which was the winter settlement of Poshtkooch Vali. Shah Abbas army followed him to Jangaleh. Shahverdi Khan was killed in Jangaleh after a tough and bloody battle (Bamdad, 1378, p. 83).

Rabino wrote about Hussein Gholi Khan Aboo Ghaddareh in his book: "Hussein Gholi Khan Aboo Ghaddareh built a castle in his summer location in Deh Bala, which was located in a valley. That building was called Kakh. It was a summer living place and a fortress. In addition, he built a great plantation outside the fort."



Hussein Gholi Khan stayed in Dumb Gholamon during winter. The name of the place was later changed to Husseineh. Aboo Ghaddareh constructed a building along Ganjan Chum River similar to the one in Deh Bala. He also built a plantation next to it. He had 2000 armed men under his command. These armed men were called "Amaleh" and they were fully equipped and armed.

Dair Kavand tribe rebelled in 1865 AD and started intruding their neighboring areas. Hussein Gholi Khan undertook to suppress the rebellion by his armed men. After his victory, his son earned Fath al-Sultan title. Aboo Ghaddareh died in 1317 AH. His son Gholam Reza Khan Sarem al-Saltaneh took over his father's reign. He earned Sardar Ashraf title later (Bamdad, 1378, pp. 88, 89).

Hussein Gholi Khan Aboo Ghaddareh constructed buildings, plantations, and a bath house in his seat of government, Hussein Abad (presently Ilam). There is no trace of these buildings now, but the ruins of the fortress along Kanjancham River, where he stayed during winter, are still visible. He died at age 68 in 1318 AH. His resting place is in Vadi al-Salam in Najaf Ashraf (Saraiee, 1379, p. 72).



حسینقلی خان ابوقداره، والی بشتکوه ۱۲۷۳-۱۳۱۸ هـ.ق.

Hussein Gholi Khan Aboo Ghaddareh, Poshtkooh Vali, 1273 AH to 1318 AH

Source: Ilam and its history

### "Hussein Gholi Khan and Nasser al Din Shah"

Zel al-Sultan used Hussein Gholi Khan several times to restore order in his territory. Hussein Gholi Khan earned the attention and favor of the powerful Qajar Prince because of his bravery and heroism. Zel al-Sultan invited Hussein Gholi Khan to wedding ceremony of his son, Jalal al-Doleh. Hussein Gholi Khan met Nasser al Din Shah in this trip and received recognition for his contributions. Nasser al Din Shah also granted Sarem al-Saltaneh and Fath al-Sultan to Gholam Reza Khan, Hussein Gholi Khan's elder son.

Hussein Gholi Khan's seat of government was in Deh Bala. He changed its name to Hussein Abad later. He ordered several tribes and nomads to permanently settle in Hussein Abad in order to help the place flourish. He built new mosques, shops, and dwellings, plus a castle for himself there.

Mozaffareddin Shah, who took over after Nasser al Din Shah passed away, confirmed the governorship of Hussein Gholi Khan Aboo Ghaddareh. He strongly reigned over Poshtkooh till his death in 1318 AH.

Gholam Reza Khan was the last Vali of Poshtkooh. He was son of Hussein Gholi Khan Aboo Ghaddareh and lived during Mozaffareddin Shah and Mohammad Ali Shah periods. His governor capital was in Hussein Abad (presently Ilam). He was the Commander of armed forces and Deputy Governor during his father's reign (Sayyah, 1359, p. 226).

Hussein Gholi Khan carried titles such as Sarem al-Saltaneh, Sardar Ashraf, and Vali Poshtkooh. He was son of Heidar Khan and grandson of Hassan Khan. He took over after his father's death in 1273 AH when of Nasser al Din Shah was Qajar King. He tried to unite Poshtkooh as soon as he became Vali. Hussein Gholi Khan used any means to implement his plan and never stop pursuing his objectives.

Hussein Gholi Khan eliminated his cousins for different reasons. He deported Abbas Gholi Khan to Tehran and Ali Gholi Khan to Zarrin Abad. He entered into a conflict with Ottoman in Baghsai (Bagh Shahi) area, which was in Iraq. Hussein Gholi Khan attached Bagh Shahi to his territory as a part of Poshtkooh.

Hussein Gholi Khan was one of the Valis whose reputation went beyond Iranian borders. He was well known more than any other Valis. One reason for his fame was the fighting he carried out with Ottoman army. Another reason was the fact that many writers and travelers who visited Iran started writing about Iran history. They would visit Hussein Gholi Khan's territory as one of the strongest in the country (Alirezaiee, 1378, p. 33).

"Hussein Gholi Khan was one of well-known higher ranking officials in Iran. He went to Tehran once along with Zel al-Sultan (in fact by order of Nasser al Din Shah) to see King's accoutrement. This

visit was arranged on Etemad al-Saltaneh's initiative as a warning to Hussein Gholi Khan to prevent him from thinking about rebellion. Qajar government honored Hussein Gholi Khan the same way they recognized other rulers (Ali Rezaee, 1378, p. 33).

Lord Curzan, the famed British traveller wrote about Hussein Gholi Khan after he met him. He wrote: Poshtkooch Vali is a brutal and cruel ruler. He has not reached age 50 yet, but he looks like a decrepit old man because he walks excessively. Hussein Gholi Khan has earned Amir Tooman or major general title (Curzan, 1365, p. 337).

DeMorgan, who was a famed French traveler and archeologist, wrote: I informed Vali about my interest to see him. It was Ramadan. Vali used to sleep all day and wake up just before sunset. I met him around five o'clock. He was with his two sons, ages 9 and 10 years. He had a cruel look on his face. He had long and dark beard like his hair. He did seem trusting and perhaps feared us. He might have thought that we came to study the area for reporting to Iran government. In spite of his fear and cold reception, he did not block our visit. He sent his men to accompany us (Saki, no date, pp. 313-314).

Historiographer Afzal al Molk wrote about Qajar Era: "Sarem al-Saltaneh (Hussein Gholi Khan) was the brave man of the time and the powerful ruler of Lorestan (Ilam). He had lots of retinue and had Lorestan under his command. Although he was endowed with lots of talents, he was always a devotee and prepared to sacrifice for his government. If Broojerd and Lorestan Valis did not put too much demand on him, he would easily pay taxes to the government (Ettehad, 1361, p. 99).

#### **The reason for Aboo Ghaddareh title**

Hussein Gholi Khan had many titles including Sarem al-Saltaneh, Sardar Ashraf, Vali, Aboo Ghaddareh (dagger holder), and Amir Tooman. Razm Ara explained the reason for calling him Aboo Ghaddareh: "Some Poshtkooch Valian had made outstanding and considerable services. Iran lacked local army in Poshtkooch area. The dedication and diligence of such valian secured the Iranian borders and returned any act of aggression by harsh reprisal.

Hussein Gholi Khan was a very brave Vali who personally took command of his riflemen and local people. He repeatedly drove back Arab tribes who were always ready for intrusion Iran for looting. Hussein Gholi Khan forced them back to Dejlh Shore after leaving lots of casualties and booty. For this reason, Hussein Gholi Khan was called Aboo Ghaddareh. This title became a family name of Valian and their families till their reign ended. It was a family name that gave them honor and respect (Razm Ara, 1320, p. 107)".

Ancestors of Hussein Gholi Khan Aboo Ghaddareh were from Bani Rabieh Arabs. Yet, he was proud of Iran and being an Iranian. He loved Iran more than anyone else. His heroism and patriotism made him a brave border guardsman and governor with no contender. He made a high contribution toward maintaining Iran's independence and territorial integrity. He defended Iran against Ottoman and Arab aggressions with all his abilities. No part of Iran was lost to enemies during their reign. They were suspicious of foreign travelers and never trusted them. DeMorgan pointed out the harsh treatment exercised by the powerful Poshtkooch Vali (Ali Rezaee, 1378, p. 35).

Hussein Gholi Khan's reputation was extended so far for his name to become a proverb. Alameh Dehkhoda wrote about the subject: "Hussein Gholi Khan or becoming Hussein Gholi Khan is attributed to Hussein Gholi Khan Vali. It refers to anarchy, havoc, and looting. It was believed that affairs were presumptive during Hussein Gholi Khan Aboo Ghaddareh and created such reputation for him (Dehkhoda, 1371, p. 7963).

The late Mohammad Mohit Tabatabaee did not attribute the proverb to Hussein Gholi Khan Aboo Ghaddareh. He wrote that his relationship with the central government hardly ever crossed Poshtkooch borders of Lorestan to reach Tehran, Mashhad, and Kerman. However, it is possible to attribute the proverb to Hussein Gholi Khan if we consider the extended infighting in different areas of Poshtkooch during Hussein Gholi Khan Era, his success in suppressing domestic rebellion such as the ones by Sigvand tribes and his cousins, deportation of many relatives to other areas of Poshtkooch and Iran, plus his engagements in many conflicts against Arabs and Ottoman.

DeMorgan wrote about Hussein Gholi Khan, the powerful Vali Poshtkooch: "Poshtkooch has maintained its freedom and independence thanks to its independent ruler, Vali Hussein Gholi Khan. He has complete control of many passageways and canyons in the area to block possible intrusions by Ottoman, Iranians, and any suspicious traveler. Poshtkooch is a part of Shah's territorial empire but he acts freely and never pays any taxes or duties".

This does not mean that Hussein Gholi Khan did not follow Tehran. On the contrary, he maintained courteous relations with Tehran governments. He was careful from afar that no government agent could enter his territory. Messengers who brought orders or letters for Vali might risk their lives when entering Poshtkooch. However, messengers were treated well once entered.

If we were to look back into history, we would realize that Poshtkooch always remained as the most

powerful governorship among its neighboring areas during many kingships that ruled Iran. DeMorgan considered Poshtkooh Valies as one of the eight ruling families who had divided Iran (DeMorgan, 1339, v. 2, p. 238). In summary, Hussein Gholi Khan was a junior kingpin and an absolute ruler of his mountainous area who was fully respected by Iranians (Alirezaee, 1378, p. 37).

#### **Gholam Reza Khan Vali (1318 AH to 1340 AH)**

Next Poshtkooh Vali, Gholam Reza Khan, had earned titles such as Fath al-Sultan, Sarem al-Saltaneh and Sardar Ashraf. He was the elder son of Hussein Gholi Khan Aboo Ghaddareh and a decedent of Hussein Kahn Salvizi who was appointed as Lorestan Vali by Shah Abbas Safavi after Shahverdi Khan was murdered.

Dikevand Tribes rebelled in 1281 AH and started attacking their neighboring areas. Hussein Gholi Khan Aboo Ghadareh, Gholam Reza Khan's father, who also carried Sarem al-Saltaneh and Sardar Ashraf, undertook to suppress them with his armed forces and cavalry, called Amaleh, on the order of the central government. Gholam Reza Khan earned Fath al-Sultan title when his father conquered the rebellious tribes. When Hussein Gholi Khan Aboo Ghadareh passed away in 1317 AH, Gholam Reza Khan Fath al-Sultan took over and earned Sarem al-Saltaneh title. He later earned Sardar Ashraf and his son, Amanollah Khan, took Sarem al-Salteneh title (Khani, 1373, p. 69).

Like most of local governors in Iran, Gholam Reza Khan was unaware of political situation in the country and did not know about motivations for friendly or aggressive relations. When Salar al-Doleh rebelled against central government for political or other reasons, Gholam Reza Khan supported him because of the family relation. Gholam Reza Khan's son, Aman Allah, became one of Salar al-Doleh commanders. Aman Allah return to Poshtkooh after Salar al-Doleh was defeated (Bamdad, 1378, V. 5, p. 170).

After this defeat, Gholam Reza Khan, who had observed Constitutionalists' victory, decided to side with them superficially. When Sardar Sepah, Iran's Prime Minister, took power (1304 - 1320), Gholam Reza Khan together with Solat al-Doleh Ghashghaiee and Sheikh Khaz'al, the sole governor of Khoozestan, made a tripartite partnership by the name of "Anjoman Sa'adeh" in defense of Constitutionalists.

From the beginning of First World War one (1914-1918), Gholam Reza Khan favored Germans following the democratic government of Mostofi al-Mamalek. He presented problems to Allied Forces (British, Russia, and France) in Koot al-Emareh. His relation with Allied countries improved later after

Major General Amir Ahmadi intermediated (Sepehr, 1325, p. 334). Gholam Reza Khan was the last Poshtkooh Vali who was defeated by Reza Shah Forces in 1307. He took refuge in Iraq and died there.

Valian ruled the area as local Khans. They armed local people, defended Iranian borders in Ilam, collected taxes from local people, and abused people through forced labor. They built summer and winter forts in Mehran and Illam areas. The remains of those forts still stand in the center of towns. The famous Ghal'eh Vali is located in Ilam and is protected as a historical site. Ghal'eh Vali presently hosts cultural activities (Khani, 1373, pp. 69, 70).

Gholam Reza Khan ordered installation of a relatively huge stone engraving with dimensions of one by two meters. This stone engraving is placed in Takht Khan (Takht Khatoon) which is located about twenty kilometers on the road from Ilam to Saleh Abad. This place had a nice climate and was a resting area for Poshtkooh Valis. This stone engraving contains a brief history of Valis and their contributions.

#### **Gholam Reza Khan Vali and Reza Khan**

Reza Shah decided in 1300 to strengthen his grip on power by suppression and forced settlement of tribes. He was especially keen about annihilation and disarming the Lorestan tribes. A conflict of interest between Poshtkooh Vali and Reza Khan was inevitable. Reza Khan was looking for a pretext to secure his power on Poshtkooh as a strategic location. He aimed at bringing down Gholam Reza Khan from power and ending his reign as Vali.

Reza Khan wrote in his travelling diaries: "An important point that took my attention was the position of Poshtkooh Vali. He stood steadfast on the way and behind Sheik Khazal with heavily armed forces. It was impossible to siege Khozestan without threatening or suppressing him. There is no option other than threatening him from behind in order to prevent him from sending out his forces in support of Arabs. I chose the longest route in spite of its difficulties by equipping state forces stationed in the northwest region (Azerbaijan) and dispatching them toward southwest of country (Alirezaee, 1378, p. 45). Ghzagh forces of Reza Khan conquered Khozestan in 1303. Reza Khan decided to remove Vali from power as his next move.

Gholam Reza Khan lived in fear of engaging in a conflict with Reza Khan forces. He even refused to go to Imperial Court when he received an invitation from the central government. All evidences made him see the dark side of himself and his family. He could see the end of his power and ruling. The time had come for an end to his family's stronghold in Poshtkooh.

When state troops reached Poshtkooh, he took his money, jewelry, and all the moveable assets he had collected by exploiting impoverished people of Poshtkooh and escaped to Iraq to settle in Baghdad in 1307. Poshtkooh finally came under central government control during the last part of Reza Khan rule. The long reign of Poshtkooh Valian finally ended by Major General Mohammad Sadegh Kopal with a decree from Reza Khan. This also marked the end of Valigari in Iran (Alirezaee, 1378, p. 47).

Gholam Reza Khan decided to return to Iran and asked for a respite from Reza Shah in 1308. Reza Shah accepted Yad Allah Khan's request and Prime Minister Hedayat (Mokhber al-Saltaneh) sent him Shah's written and stamped statement with a Quran as the proof of respite inviting father and son to return to Iran. However, Gholam Reza Khan changed his mind after hearing that Alvar tribal chiefs of Lorestan were hanged by General Hussein Khan Kazaee upon return to Khoram Abbad in spite of promises not be harmed and the respite issued by the central government.

### Summary

Valian Lorestan strengthened their hold on Lorestan (and Ilam) during the early parts of Qajar Dynasty. Fath Ali Shah decided to install Qajar rulers all over country to reinforce his power and avoid possible rebellion. He dispatched Qajar princesses to different parts of country. The western region of Iran was given to Fath Ali Shah's brave son, Mohammad Ali Dolatshah.

Hassan Khan, Vali Lorestan (1215 to 1255 AH), was forced to retreat from Khoram Abad to Poshtkooh (presently Ilam) under pressure from the central government. Filly Valian of Poshtkooh heeded less to the central government more than before.

Haidar Khan Vali (1255-1273 AH), one of Poshtkooh Valian, shared ruling the area with his brothers Ali Khan and Ahmad Khan. But, Haider Khan was the only one approved by the central government.

The most well known Filly Valian of Poshtkooh were Hussein Gholi Khan Aboo Ghadareh (1273-1318 AH) and his son Gholam Reza (1318-1307) who was appointed by Mozafar al Din Shah as Poshtkooh Vali. Gholam Reza Khan was forced to flee Iran in 1307 after Reza Khan (1304 to 1320) came to power and attempted to centralize the government power.

Gholam Reza Khan, the last Filly Vali of Poshtkooh, ordered the installation of a stone engraving in a place called Takht Khan, located 34 kilometers south of Ilam on the road from Ilam to Tehran. His intended purpose was to save his name and his family by leaving a record of the family history and the accomplishments his family had made.

The stone engraving is 520 centimeters high, 810 centimeters wide, and 700 centimeters deep. The stone is installed on the west wall at 250 centimeters above ground. The writing is in Kufi scripture. Letters stand out 4 centimeters from a relatively leveled and polished surrounding surface. The lines were not evenly spaced and the style of writing has given it a beautiful appearance.

### Acknowledgements:

The Author is grateful to professor Garnik Asatourian and Department of history at Academy of Sciences in Yerevan, Armenia

### Corresponding Author:

Ebrahim Yaghobi<sup>1</sup>, Sivash Yari<sup>2</sup>

<sup>1</sup>Permanent Member of Iran Historic Society, Author and Researcher, Ilam University Instructor

<sup>1</sup>Education Organization

<sup>2</sup>Faculty member Ilam University, Ilam, Iran

Mobile: +989188430013

[Yaghobi6@yahoo.com](mailto:Yaghobi6@yahoo.com)

[Cia839@yahoo.com](mailto:Cia839@yahoo.com)

### References

1. Afshar Sistani, I. (1372). *Ilam and its History*, 1<sup>st</sup> Edition, Tehran
2. Alirezaee, K. (1350) *History and Culture of the Ancient Land: Ten Thousand Years of Historical, Social, and Cultural Background of Dehloran and Ilam Province*, 1<sup>st</sup> Edition, Mehranshar Publishing
3. Bamdad, M. (1378), *Biography of Iranian Statesmen in 12<sup>th</sup>, 13<sup>th</sup>, and 14<sup>th</sup> Centuries*, v. 5, 3<sup>rd</sup> Edition, Zavar Publishing
4. Curzan, G. (1365) *Iran and Iran Issues* (trans. Mazandarani, V.), 1<sup>st</sup> Edition
5. Dehkhoda, A. A. (1371) *Dehkhoda Dictionary*, Tehran: Dehkhoda Dictionary Institution
6. DeMorgan, J. (1339) *The Geography of western Iran* (trans. Vadiee, K.) Tabriz: Chehreh Publishing
7. Etemad al-Saltaneh Mohammad Hassan Khan (1364) *Arranged Nasser History: Narrated by Mohammad Ismail Rezvani*, 1<sup>st</sup> Edition, Ziba Publishing
8. Greoteh, Hugu with Groteh Travelling Logbook (trans. Jalilvand, M.), Tehran: Central Publishing
9. Ilam Culture Research Quarterly (1383), nos. 18 and 19
10. Karimi, B. (1378) *History and Culture of Badareh People*, Master's Thesis, History Department, Shahid Beheshti University, Shahrivar

11. Khani, M. H. (1373) *A Review of Ilam History*, 1<sup>st</sup> Edition  
Campus in Cooperation with Iran Shenacy Center of Ilam Campus
12. Khoda Bakhshi, R. (1384) *Political History of Lorestan*, 1<sup>st</sup> Edition, Khoram Abad: Aflak Publishing
13. Mahalati, H. S. Haj Sayah Memoir or the Period of Fright and Terror, Collected by Sayah, H, Edited by Golcar, S., Tehran: Ibn Sina Library Distribution Center
14. Mahmodian, H. (1377) *A Study of Bronze Remains in Ilam and Lorestan*, 1<sup>st</sup> Edition, Sabz Royesh Publishing and Cultural Institute
15. Mahmodian, H. (1383) *An Introduction to Ilam Geography*, 1<sup>st</sup> Edition
16. Mortens, I. D. (1377) *Lorestan Nomads* (trans. Arya, M. H.) 1<sup>st</sup> Edition, Pazhuhandeh Publishing
17. Narad, N. (1374) *History of Ilam Territory*, 1<sup>st</sup> Edition, Arghanoon Publishing
18. Nemati, N. (1383) *Ilam Province Documents*, Azad University Research Program, Ilam
19. Nemati, N., Rajabi, N. (1383) *The History of Education in Ilam*, Tehran: Sepand Honar
20. Razm Ara, A. *The Military History of Postkooch*, Published by Geographical Institution of Armed Forces
21. Rowlinson, H. (1362) *Rowlinson Travelling Logbook*, (trans. Aman Allahi Baharvand, S.) Tehran: Aghah Publishing
22. Saki, A. M. *The Geographic History and History of Lorestan*, 1<sup>st</sup> Edition, Khoram Abad: Mohammadi Publishing
23. Saraee, Z. (1379) *The Poet of Foggy Pinnacles: Research, Editing, and Translation*, Tehran: Goyeh Publishing
24. Sepehr, Movarekh Al-Doleh (1325), *Iran in the Major War*, 1<sup>st</sup> Edition, Bank Melli Publishing
25. Zel al-Sultan, M. M. (1364) *Masood History*, Yavali Publishing.

11/13/2012

**The First Report for the invasion of *Artemia franciscana* Kellogg 1906 in Tashk and Bakhtegan Lakes, Iran**Sepideh Shafaie<sup>1</sup>, Samad Zare<sup>2</sup>, Ramin Manaffar<sup>3</sup> and Afagh Falahati<sup>4</sup>

Msc student, Department of Biology, Faculty of Science, Urmia University, Iran

<sup>1</sup> professor, Department of Biology, Faculty of Science, Urmia University, Iran<sup>2</sup>, Artemia and Aquatic Animals Research Institute, Urmia University, Iran

Msc student, Fishery department, Bandar Abbas Branch, Islamic Azad University, Bandar Abbas, Iran

**Corresponding author: Sepideh Shafaie**

Iran, Urmia, Shahid Beheshti Ave. Urmia University, Artemia and Aquatic Animals Research Institute

P. O. Box 165 Tel. 09143478679, E-mail. [s.shafaie87@yahoo.com](mailto:s.shafaie87@yahoo.com)

**Abstract:** *Artemia*, a small crustacean, with high commercial value is a valuable model organism for researchers. This creature by tolerating extreme range of different environmental conditions was dispersed to more than 600 and 18 sites over the world and Iran, respectively. Tashk and Bakhtegan Lakes are one of the natural parthenogenetic *Artemia* habitats in Iran. Due to occurrence of an unknown bisexual *Artemia* in Tashk Lake, the species of this endemic *Artemia* was inferred. In this regard, four different molecular markers as Na/K ATP-ase, 12S-16S by PCR-RFLP technique and COI and HSP26 by sequencing and subsequent Genbank data were studied. The conducted analyses with emphasizing to ability of molecular techniques for identifying unknown species characterized the new population as *A. franciscana* in these two lakes. These analyses also revealed a molecular diversity between the sequenced genes with the data found in the Genbank.

[Sepideh Shafaie, Samad Zare, Ramin Manaffar, Afagh Falahati. **The First Report for the invasion of *Artemia franciscana* Kellogg 1906 in Tashk and Bakhtegan Lakes, Iran.** *Life Sci J* 2012;9(4):3020-3024]. (ISSN: 1097-8135). <http://www.lifesciencesite.com>. 443

**Keywords:** *Artemia*- Bisexual-parthenogenetic-Tashk Lake- Bakhtegan Lake.

**1. Introduction**

Brine shrimp *Artemia* is one of the important zooplanktons in aquaculture. Having special physiological adaptabilities such as the capability of producing resistant cysts, a very effective osmotic pressure regulation system, *Artemia* has been adapted to the life in salty and very salty water. In fact, among Metazoan, *Artemia* is the only creature that can endure high degrees (up to 300 gr per liter) of saltiness (Browne, 1992). In addition to its great nutritional value (fatty acids and necessary proteins), *Artemia* is an appropriate research model in molecular and evolutionary experiments. This genus harbors two bisexual (comprising of six species) and parthenogenetic strains (Van Stappen, 2008). Each of these populations has been adapted to different climates and habitats based on their molecular characteristics and physiologic. In 1995, the first official paper has referred to only 80 areas as *Artemia* habitats (Abonyi, 1915), while around 600 geographical regions has been introduced as *Artemia* habitats in the latest list of the year 2002 (Van Stappen et al, 2002). The fast dispersion of *Artemia* around the earth and also the discovery of new regions through developments in specific researches is the reason for the change in dispersion list of *Artemia*. Likewise, the extinction of *Artemia* in some regions (such as Lamington region in England and Shurabil Lake in

Iran) can also make changes in the habitat and dispersion list of *Artemia* (Van Stappen, 2008).

So far, 18 different sites of *Artemia* have been reported in Iran (Abatzopoulos et al, 2006; Asem et al, 2009). All of these sites, except Urmia Lake, have the endemic parthenogenetic *Artemia*. The geographical position of Bakhtegan Lake, the lake in Fars province of Iran, is 53° 50' N and 29° 40' E and it is located at a distance of 80 Km from the east of Shiraz. Tashk Lake, the other lake in Fars province, in geographical position of 53° 50' N and 29° 60' E is located at a distance of 50-160 Km from the east of Shiraz (Agh, 2007). Tashk lake was previously introduced as Brackish Lake that had connection to Bakhtegan Lake via a connective bridge. Therefore, the saltiness of water has been increased which has made this region a biologically suitable place for parthenogenetic *Artemia* (Agh, 2007). The temperature of these lakes which has adaptability to thermo iso-plates of the region is between less than 5 degrees and more than 40 degrees and even reaches to 45°C in sloughs (Alamdari, 1987). There is no idea about the first report of parthenogenetic *Artemia* in these lakes, but several reports has been recorded about the existence of parthenogenetic *Artemia* in these lakes in 1980, 1984, 2002, and 2007 (Geddes, 1980; Browne et al, 1984; Van Stappen et, 2002; Agh, 2007).

*A. franciscana*, as one of the very potatic bisexual species in the world (with great frequency 74

sites) is the dominant *Artemia* species in Great Salt Lake, U.S. (Van Stappen, 2002). In fact, the high and fast adaptability capacity of this species in new ecosystems has caused it to be selected for commercial Pond production industry in most of the countries (Amat et al, 2007). The molecular and physiological capacity of *A. franciscana* to a wide domain of ecological conditions and also the high growth velocity and reproduction potential of this *Artemia* has caused it to be easily dispersed around the world.

The studies have indicated that the molecular adaptability power of the *Artemia* (specially *A. franciscana*) is the main reason for this wide dispersion. It is inferred that some genes of heat shock proteins (HSPs) or mitochondrial genes can show these molecular changes quickly in a way that they have been considered as the successful adaptability criterion to new conditions. The researches have indicated that these chaperon proteins has a vital role in increasing physiological adaptability of the living creature facing with unpleasant biological conditions (Clegg et al, 2000). These proteins change a lot in *Artemia* which have experienced a successful period in a new and different habitat (Bossier et al, 2009). It has been proven that other proteins of this family also have significant role in stress tolerance and creating molecular adaptability (Federand and Hofmann, 1999; Prohaszka and Fust, 2004).

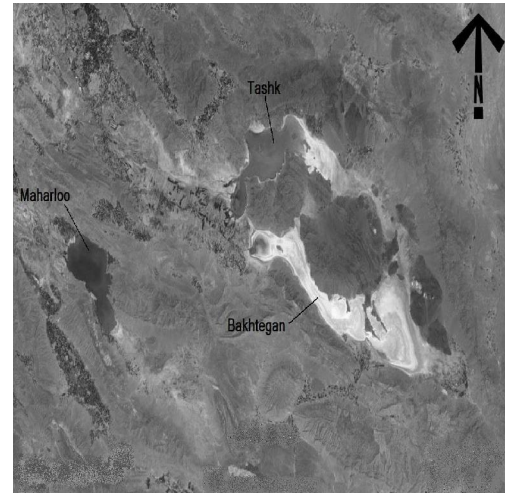
In order to investigate the species diversity of *Artemia*, different methods have been introduced including different types of morphometric and molecular techniques. Mitochondrial genome performance has been confirmed as an appropriate option for identification of indefinite taxon, analysis of species creation and even identification of *Artemia* population (Avisé, 2000; Bossier et al, 2004). Likewise, a molecular method has been presented recently in order to recognize the level of parthenogenetic from bisexuality level which can be used for the separation of these two levels (Manaffar et al, 2011).

Since *A. urmiana* is the only endemic bisexual *Artemia* population observing a huge population of bisexual *Artemia* in Tashk and Bakhtegan Lakes, the identification of level and species of the observed *Artemia* was considered as the main goal of the present study.

## 2. Material and Methods

*Artemia* cysts were collected from four different parts of Tashk and Bakhtegan Lakes which located in Fars province in July 2011 (Figure 1). The cysts were hatched after rinsing and purification in standard laboratory conditions in Urmia Lake water which was diluted to the saltiness of 35 gr per liter, a temperature of 27°, pH=8, and equipped with aeration systems and

enough light (Lavens and Sorgeloos, 1996). Instar I were nauplii transferred into one liter bottles containing 80 gr per liter saline water in 4 repetitions and reached for 20 days with mixture of enriched yeast with fatty acid, and unicellular Alga *Dunaliella salina* (Coutteau et al, 1992).



**Figure 1- Location of Tashk and Bakhtegan Lakes which are near the Maharloo Lake.**

### 2.1. Molecular analysis

The DNA were extracted from cyst individuals of cyst using Chelex method (Estoup et al, 1996). In order to extract DNAs of the mature *Artemia* samples, the CTAB method was used (Doyle and Doyle, 1990).

In order to investigate the species diversity of unendemic of *Artemia* population in Tashk and Bakhtegan Lakes, 20 samples (cyst and mature *Artemia*) were used. To this end, genetic parts of Na/K ATPase (a part of core genome for identification of bisexually or parthenogenetic) (Manaffaret al, 2011) and 12s-16s (a part of mitochondrial genome for identification of *Artemia* species) (Bossier et al, 2004) were used.

PCR program and also used primers have been summarized in Table 1. The PCR product were analyzed in all experiments using the electrophoresis of 2% Agarose gel and photographed by Gene Flash gel. Documentation system after approving the quality of PCR product in RFLP technique, in order to characterize strain and species of *Artemia* the exon-7 fragment of Na- K ATPase gene and the 12s-16s gene fragment were digested by Tru I and Hpa II restriction digestion enzymes and they were analyzed on 2% Agarose gel. Fragments of HSP26 and COI genes were also sequenced by Sina Gene Company. (Folmer et al, 2006).

Table 1. primers and PCR program

	Forward and reverse primers	programPCR
Na/K ATPase	-cca-aac-gta-tgg-ctt-c-3' 5'-cag -agc-acg-act-gca-aga-3' 5'-gaa-ttc	94°C 2 Min 35 cycle (94°C 2 Min, 56°C 25 Sec, 72°C 1 Min) 72°C 3 Min
COI	-atc-ata-aag-ata-tgt-g-3' 5'-ggt-aca -tga-cca-aaa-aat-ca -3' 5'-taa-act-tca-ggg	95°C 3 Min 33 cycle (95°C 1Min, 50°C 1 Min, 72°C 1.20 Min) 72°C 10 Min
12S-16S	-cca-aac-gta-tgg-ctt-c-3' 5'-cag -agc-acg-act-gca-aag-3' 5'-gaa-ttc	95°C 2 Min 34 cycle (94°C 1.15 Min, 52°C 1 Min, 72°C 2 Min) 72°C 4 Min
HSP 26	-gga-gaa-gaa-tga-gaa-g-3' 5' -tgg-acg-tgt-cca-tat-tc-3' 5'-tct-ctt	94°C 2 Min 35 cycle (94°C 15 Sec, 54°C 25 Sec, 72°C 30 sec) 72°C 4 Min

### 3. Results

The analysis of the implied a 700 bp which can be related to cytochrome oxidase gene and 217 bp fragment which can be related to heat shock gene of HSP 26 indicated that the sequence of the PCR product also checked in Genbank data base by Blast Run. Enzymatic cutting of piece number 280 bp of core genome which is produced by *Tru11* showed that the created cutting pattern in *Artemia* samples of Tashk and Bakhtegan Lakes, are exactly similar to the pattern of Bisexual *Artemia* (Figure 2).

In order to analyze the species of *Artemia*, the enzymatic cutting of piece number 1500 bp of 12S-16S mitochondrial genome was used. Enzyme cutting by the limitative *HpaII* enzyme created the profile figure of *A. franciscana* (Figure 3). Analysis of the sequence results using Genbank internet search by Blast software emphasized that the above bisexual *Artemia* belongs to the bisexual American *Artemia* in molecular structure of this gene in comparison to genes recorded in gene bank.

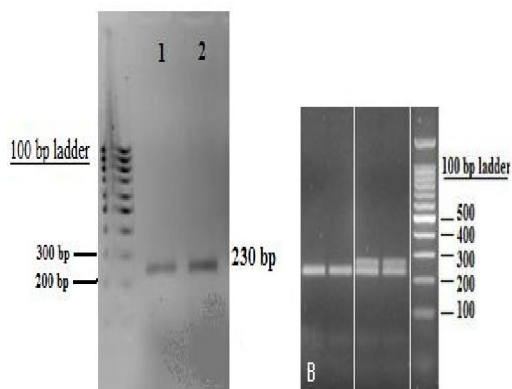


Figure 2- Agarose gel of restriction enzyme fragment of 280 bp region Image A): 230 bp band was produced from Brine Shrimp samples (1: Tashk Lake, 2: Bakhtegan Lake)

Image B): taken from the reference gel. Manaffar et al, 2011 pattern, cut two bands of parthenogenetic *Artemia* and Single-band pattern is indicative of bisexual *Artemia*.

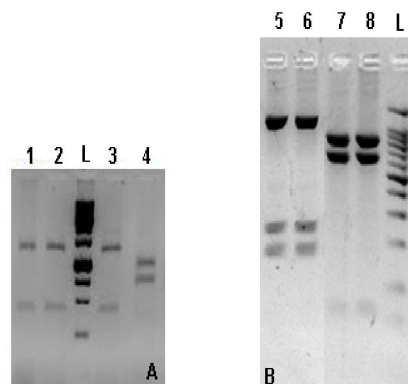


Figure 3. Agarose gel electrophoresis of 12S-16S fragment of 1500 bp region of the enzyme restriction by the enzyme *HpaII*. Images were: Image A) Restriction enzyme fragment above the exotic *Artemia* in Tashk (sample 1) Bakhtegan (sample 2) control samples (3. *A. franciscana* and 4. *A. sinica*) with 1 Kb marker. Reference gel from (Bossier et al, 2004) samples 5 and 6 related to *A. franciscana*, samples 7 and 8 related to *A. sinica* with 100 bp ladder.

### 4. Discussion

The present study is considered as the first report about the observation of *A. franciscana* in Tashk and Bakhtegan Lakes, the lakes of Fars province. Some scientific analysis had already confirmed the existence of *A. franciscana* in Iran Plateau (natural habitat of *Artemia*) (Manaffar et al, 2008). In present study, it was attempted to use new technique which forecast genetic distinction patterns and extend diversity in several creatures with little error (Chow et al, 2006). The merits of the used molecular methods for strain and species identification of *Artemia* was already approved. But, setting sequences of cytochrome oxidase and also small heat shock protein and the analysis of its sequence with samples of gene bank indicates a genetic difference of more than 30% between tested *Artemia* and existed samples from the above-mentioned website. Of course, the effect of other phenomenon such as Founder effect and genetic drift should not be neglected. Regardless it should be noted that this new population have managed to adapt themselves to Tashk and Bakhtegan Lakes successfully.

However, with regard to the probable method of transferring this species of *Artemia* to Tashk and Bakhtegan Lakes, it should be mentioned that although



the *Artemia* egg is generally transferred by wind and aquatic birds (Persoone and Sorgeloos, 1980), but from 1970s until now, humans have been responsible for dispersion of *Artemia*, specially *A. franciscana*. Regarding to existence of *A. franciscana* in Maharloo Lake and also close distance of these three lakes, it is suggested that *A. franciscana* have been transferred from Maharloo Lake to these Lakes by birds.

*Artemia* has shown the highest level of phenotypical and genetic flexibility and with a very high reproduction speed, quick adaptation to difficult conditions and molecular adaptability with environment it has been dispersed successfully in Asia, Europe, and America and has often caused the elimination of local *Artemia* (Browne et al., 1988; Kappas et al, 2004; Pogge, 2004). With the transfer of this species in 1970s to the island of Pacific Ocean and Brazil, it was announced that the above species will probably substitute other species including *A. Salina* (Van Stappen et al, 2002). However, the first report about the offensive power of *A. franciscana* is related to Camara in 2001 who has reported that this species is located in Rio Grand do Norte in northern Brazil. Other similar report have been recorded in Portugal (Amat et al, 2005), France (Thiery, 1992), Egypt (Triantaphyllidis et al, 1998), Italy (Mura et al, 2004), Spain and Morocco (Amat et al, 2007). Research done by Kappas in 2004 on non-local *A. franciscana* in Vietnam indicated that there are significant differences between local American *A. franciscana* and commercial Vietnamese *Artemia* which had been transferred to Vietnam 10 years ago.

It should be noted that the permanent settlement of non-local *Artemia* population and the development in dispersion of *A. franciscana* around the world have been one of the note worthy issues in recent years (Abatzopoulos et al, 2006; Amat et al, 2005, green et al, 2005; Mura et al, 2006). At present, *A. franciscana* is considered as the dominant population in the west of Mediterranean Sea, Slat mines in Portugal, Mediterranean beach of France, and the Cadiz Gulf in Spain (Amat et al, 2005). This study has proved that *A. franciscana* has been able to eliminate local population within a few years (Amat et al, 2005; Green et al, 2005; Amat et al, 2007). Researches in Iran have also indicated that *A. franciscana* has managed to become a dominant population in Nogh Pool of Rafsanjan (which was a natural habitat for parthenogenetic *Artemia*) in a contest with parthenogenetic *Artemia* (Abatzopoulos et al, 2006).

According to the results of the present study the found genetic diversity in *A. franciscana* and also its potential capability, it is expected that this bisexual species may be able to completely eliminate local parthenogenetic *Artemia* population in the future.

## References

1. Abatzopoulos, T.J., Agh, N., Van Stappen, G., Razavi Rouhani, S.M., Sorgeloos, P., 2006. *Artemia* sites in Iran. *Journal of the Marine Biological Association of the United Kingdom* 86, 299-307.
2. Abonyi, A., 1915. Experimentelle Daten zum Erkennen der *Artemia*-Gattung. *Zeitschrift für Wissenschaftliche Zoologie* 114, 95-168.
3. Agh, N., 2007. Characterization of *Artemia* population from Iran. PhD thesis. Ghent University, Belgium, P 8-16.
4. Alamdari, A., 1987. Limnology and preserving of ecologic dynamic of Bakhtegan wetland.
5. Amat, F., Hontoria, F., Ruiz, O., Green, A.J., Sanchez, M.I., Figuerola, J., Hortas, F., 2005. The American brine shrimp as an exotic invasive species in the western Mediterranean, *Biological Invasions* 7, 37-47.
6. Amat, F., Hontoria, F., Navarro, J.C., Vieira, N., Mura, G., 2007. Biodiversity loss in the genus *Artemia* in the Western Mediterranean Region, *Limnetica* 26, 387-404.
7. Asaadi, R., Sardashti, M., Karami, M., Golzar, Y., 2011. The visit report of Tashk, Maharlo and Bakhtegan Wetlands. Under supervision of Ministry of Power, 4 pp.
8. Asem, A., Atashbar, B., Rastegar-Pouyani, N., Agh, N., 2009. *Zoology in the middle east* 47, 1-4.
9. Avise, J.C., 2000. *Phylogeography: The History and Formation of Species*. Harvard University Press, Cambridge, MA, 447 pp.
10. Bossier, P., Xiaomei, W., Catania, F., Dooms, F., Van Stappen, G., Naessens, E., Sorgeloos, P., 2004. An RFLP database for authentication of commercial cyst samples of the brine shrimp *Artemia* spp. (International Study on *Artemia* LXX). *Aquaculture* 231, 93-112.
11. Bossier, P., Gajardo, G., Beristain, P., 2009. Species-specific RFLP pattern in the Heat Shock Protein 26 gene a single-locus tool for species identification and experimental testing of habitat-induced isolation in the New world *Artemia* species. *Molecular Ecology Resources*. Vol.10, pp. 229-231.
12. Browne, R.A., Sallee, S.E., Grosch, D.S., Sergetti, W.O. Purser, S.M., 1984. Partitioning genetic and environmental components of reproduction and life span in *Artemia*. *Ecology* 65, 949-960.
13. Browne, R.A., Davis, L.E., Sallee, S.E., 1988. Temperature effects on life history traits and relative fitness of sexual and asexual *Artemia*. *Journal of Experimental Marine Biology and Ecology* 124, 1-20.
14. Browne, R., 1992. *Population genetics and ecology of Artemia: Insights into parthenogenetic reproduction*. Elsevier Science Publishers Ltd. *Trends in Ecology and Evolution* 7, 232-237.
15. Camara, M.R., 2001. Dispersal of *Artemia franciscana* Kellogg (Crustacea; Anostraca) populations in the coastal saltworks of Rio Grande do Norte, northeastern Brazil, *Hydrobiologia* 466, 145-148.
16. Chow, S., Suzuki, N., Imai, H., Yoshimura, T., 2006. Molecular species identification of spiny lobster phyllosoma larvae of the genus *Panulirus* from the Northwestern Pacific Marine Biotechnology 8, 260-267.

17. Clegg, J.S., Jackson, S.A., Van Hoa, N., Sorgeloos, P., 2000. Thermal resistance, developmental rate and heat shock proteins in *Artemia franciscana* from San Francisco Bay and southern Vietnam. *Journal of Experimental Marine Biology and Ecology* 252, 85-96.
18. Coutteau, P., Brendonck, L., Lavens, P., Sorgeloos, P., 1992. The use of manipulated baker's yeast as an algal substitute for laboratory culture of Anostraca. *Hydrobiologia* 234, 25-32.
19. Doyle, J.J., Doyle, J.L., 1990. Isolation of plant DNA from fresh tissue. *Focus* 12, 13-15.
20. Estoup, A., Largiader, C.R., Perrot, E., Chourrou, D., 1996. Rapid one-tube DNA extraction for reliable PCR detection of fish polymorphic markers and transgenes. *Molecular marine biology and biotechnology* 5, 295-298.
21. Feder, M.E., Hofmann, G.E., 1999. Heat Shock Proteins, Molecular Chaperones, and the Stress Response. *Annual Review of Physiology* 61, 243-282.
22. Folmer, O.M., Black, W., Hoeh, R., Lutz, R., Vrijenhoek, R., 1994. DNA primers for amplification of mitochondrial cytochrome oxidase subunit I from diverse metazoan invertebrates. *Molecular Marine Biology and Biotechnology* 3, 294-299.
23. Geddes, M.C., 1980. The brine shrimp *Artemia* and *Parartemia* in Australia. In: Persoone, G., Sorgeloos, P., Roels, O., Jaspers, E. (Eds.), *The Brine Shrimp Artemia*, Vol. 3, Universa Press, Wetteren, Belgium, pp. 57-65.
24. Green, A.J., Sanchez, M.I., Amat, F., Figuerola, J., Hontoria, F., Ruiz, O., Hortas, F., 2005. Dispersal of invasive and native brine shrimps *Artemia* (Anostraca) via waterbirds. *Limnology and Oceanography* 50, 737-742.
25. Kappas, I., Abatzopoulos, T.J., Van Hoa, N., Sorgeloos, P., Beardmore, A.J., 2004. Genetic and reproductive differentiation of *Artemia franciscana* in a new environment. *Journal of Marine Biology* 146, 103-117.
26. Kellogg, V.A., 1906. A new *Artemia* and its life condition. *Science* 24, 594-596.
27. Lavens, P., Sorgeloos, P., 1996. *Manual on the production and use of live food for Aquaculture*. Laboratory of Aquaculture and Artemia Reference Center, University of Gent, Belgium. Published by: Food and Agriculture Organization of the United Nations (FAO Fisheries Technical Paper). P 1-295.
28. Manaffar, R., Falahati, A., Moshtagiyan, A., Mosavi, S.M., Atashbar, B., Asem, A., 2008. First report for existence of *Artemia franciscana* coexistence with endemic parthenogenetic *Artemia* population in inside of the Lake Maharlu, Iran. Conference of world aquaculture, Bussan, Korea.
29. Manaffar, R., Zare, S., Agh, N., Abdolazadeh, N., Soltanian, S., Sorgeloos, P., Bossier, P., Van Stappen, G., 2011. SNP detection in Na/K ATP-ase gene a1 subunit of bisexual and parthenogenetic *Artemia* strains by RFLP screening. *Molecular Ecology Resources* 11, 211-214.
30. Mura, G., Amat, F., Abatzopoulos, T.J., Moscatello, S., 2004. First record of *Artemia franciscana* in an Italian saltwork, Fifth International Large Branchiopod Symposium, Book of abstracts Toodyay, Western Australia, pp. 35-36.
31. Mura, G., Kappas, I., Baxevanis, A.D., Moscatello, S., D'Amico, Q., Lopez, G.M., Hontoria, F., Amat, F., Abatzopoulos, T.J., 2006. Morphological and molecular data reveal the presence of the invasive *Artemia franciscana* in Margherita di Savoia salterns (Italy). *International Review of Hydrobiology* 91, 539-554.
32. Persoone, G., Sorgeloos, P., 1980. General aspects of the ecology and biogeography of *Artemia*. In: *The brine shrimp Artemia*. Vol.3. Ecology, Culture, Use in Aquaculture, Persoone, G., Sorgeloos, P., Roels, O., Jaspers, E. (Eds.), Universa Press, Wetteren, Belgium, pp. 3-24.
33. Pogge, C., 2006. *Bio 25, San Francisco bay ecology, brine shrimp*, P.1-8.
34. Prohaszka, Z., Fust, G., 2004. Immunological aspects of heat-shock proteins- The optimum stress of life. *Molecular immunology* 41, 29-44.
35. Qui, Z., Bossier, P., Wang, X., 2006. Diversity structure and expression of the gene for p26 a small heat shock protein from *Artemia*. *Genomics* 88, 230-240.
36. Triantaphyllidis, G. V., Abatzopoulos, T.J., Sorgeloos, P., 1998. Review of the biogeography of the genus *Artemia* (Crustacea, Anostraca). *Journal of Biogeography* 25, 213-226.
37. Thiéry, R., Robert, F., 1992. Bisexual populations of the brine shrimp *Artemia* in Sète-Villeroi and Villeneuve saltworks (Languedoc, France). *International Journal of Salt Lake Research* 1, 47-63.
38. Van Stappen, G., 2002. Zoogeography. In: Abatzopoulos, Th.J., Beardmore, J.A., Clegg, J.S., Sorgeloos, P. (Eds.). *Artemia: basic and applied biology*. Kluwer Academic Publishers, Dordrecht, the Netherlands. pp. 171-224.
39. Van Stappen, G., 2008. *Artemia biodiversity in Central and Eastern Asia*. Ph.D Thesis. University of Ghent, Ghent, Belgium, P 1-179.

## The renal toxicity of hydroalcoholic extract of *Stachys lavandulifolia* Vahl in Wistar rats

Taghikhani M<sup>1</sup>, Nasri H<sup>1</sup>, Asgari A<sup>1</sup>, Afrough H<sup>1</sup>, Namjoo AR<sup>2</sup>, Ansari-Samani R<sup>1</sup>, Shahinfard N<sup>1</sup> and Rafieian-kopaei<sup>1\*</sup>

<sup>1</sup>Medical Plants Research Center, Shahrekord University of Medical Sciences, Shahrekord, Iran

<sup>2</sup>Department of Clinical Sciences, Faculty of Veterinary Medicine, Islamic Azad University, Shahrekord Branch, Shahrekord, Iran

\*Corresponding author: Medical Plants Research Center, Shahrekord University of Medical Sciences, Shahrekord, Iran; Email: [rafieian@yahoo.com](mailto:rafieian@yahoo.com)

**ABSTRACT:** *Stachys lavandulifolia* is used as the herbal tea in gastrointestinal disorders. It is believed that this plant has beneficial curative properties. However, more studies are needed to determine the toxic effects of plant. The aim of this study was to evaluate the nephrotoxicity of hydro-alcoholic extract of *Stachys lavandulifolia* Vahl on male Wistar rats. In this experimental study, 100 adult male Wistar rats (200-250 g) were divided into 5 groups of 20; including one control and 4 experimental groups, and injected i.p saline or *Stachys lavandulifolia* Vahl extract (50,100,150 and 200 mg/kg) for 1 month. Then sampling was done from half of the animals of each group. The left animals in each group were held without injection for one more month and then sampling was done. In the groups that *Stachys lavandulifolia* Vahl extract were used for one month, a mild degeneration of renal tubular epithelial cell was observable. However, in the second month of the study, the histologic lesions were significantly more ( $P < 0.05$ ). *Stachys lavandulifolia* Vahl extract has renal tubular toxicity and this toxicity may continue even following drug discontinuation. However, further studies need to evaluate renal complications of this drug in human.

[Taghikhani M, Nasri H, Asgari A, Afrough H, Namjoo AR, Ansari-Samani R, Shahinfard N and Rafieian-kopaei. **The renal toxicity of hydroalcoholic extract of *Stachys lavandulifolia* Vahl in Wistar rats.** Life Sci J 2012;9(4):3025-3031] (ISSN:1097-8135). <http://www.lifesciencesite.com>. 444

**Keywords:** Lamiaceae family, Therapeutic properties, Renal toxicity, Tubular degeneration

### Introduction

For thousands of years people have used plants and herbs as curative elements (1,2). *Stachys lavandulifolia* (Lamiaceae) is widely used in various parts of the world as herbal tea. It is used for the treatment of gastrointestinal and respiratory disorders. The genus *Stachys*, which belongs to the Lamiaceae family, consists of about 280 species (3-6). Plants of this genus also exhibit dose-dependent antibacterial activities against different bacteria. The extracts are more active against Gram-positive microorganisms compared to Gram-negative bacteria (7). The

plant has also some anti-tumor activity (8). This effect is attributed to flavonoids, phenylpropanoids or terpenoids of the aerial parts of this plant (9-11). Germacrene-D, betaphellandrene, beta-pinene, myrcene and alpha-pinene have been reported to be the main components of the essential oil of *S. lavandulifolia* (9-11).

A phenylethanoid glycoside, lavandulifolioside A, lavandulifolioside B, verbascoside, leucosceptoside A, and an iridoid glycoside, 5-O- $\beta$ -allopyranosyloxy-aucubin have also been isolated from the flowering aerial parts of the

plant (10). The existence of flavonoids such as apigenin and luteolin are also demonstrated in aerial parts of *S. lavandulifolia* (11).

In spite of widespread use in Iran, the pharmacological characteristics of the *Stachys lavanduifolia* and its probable toxicities have not been studied in detail. Therefore, the aim of this study was to evaluate the renal effect of hydroalcoholic extract of *Stachys lavandulifolia* Vahl in male Wistar rats.

## Materials and methods

### Extraction method

Aerial part of *Stachys lavandulifolia* Vahl was gathered from Chaharmahal & Bakhtiyari province in Iran, in July 2011 and authenticated at the Medical Plants Research Center, Shahrekord University of Medical Sciences (Voucher no 78).

The *Stachys lavandulifolia* Vahl leaves were dried and powdered. Then, 500 grams of the powder were macerated with ethanol (70%) at 28°C for 24 hours and filtered. The extraction process continued two times and then was concentrated in a rotary evaporator under low pressure to give one third of the primary volume. The solution was then dried by oven at 40°C. The dried extract was reconstructed with distilled water to make 50, 100, 150 and 200 mg/kg doses.

### Experimental studies

In this experimental study, 100 adult male Wistar rats (200-250 g) were used. The animals were divided randomly into 5 groups of 20; including one control and 4 experimental groups. Five groups of animals were injected i.p saline or *Stachys lavandulifolia* Vahl extract (50, 100, 150 and 200 mg/kg) for 1 month. Then sampling was done from half of the animals of each group (13-16). The left animals in each group were held without injection for one more month and then sampling was done.

### Histology

After the rats were anesthetized with ether, systematic method of dissection was done. Sterile incision was made in the specific location. Kidneys were removed and examined. Then a longitudinal incision was made on kidneys. One half of kidney for staining with hematoxylin and Eosin (H&E) was placed in 10% buffered formalin solution for 24 hours. The Staining routine method with H&E was done and histopathology slides were prepared. Using optical microscopy the toxicity was evaluated qualitatively (12-20). Statistical analysis was done using Chi-square test.

### Results

Effects of *Stachys lavandulifolia* Vahl extract on renal tubular epithelial cells after first month is shown in table 1. Following one month drug usage the degeneration of renal tubular epithelial cell was mild. In the second month (one month after drug cessation) there was a significant increase in renal tubular epithelial cells degeneration compared to the first month. The results indicate that the degeneration of renal tubular epithelial cells was increased with time, even after drug cessation ( $P < 0.05$ ). Table 2 also shows that the necrosis of epithelial cells in the second month have been more than first month ( $P < 0.05$ ).

The result of interstitial mononuclear cell infiltration in kidneys of rats showed that the amount of infiltration in the first and the second months was almost identical (Table 3). The amounts of fibrous tissue in the medulla of the kidney tissue sections as well as the mononuclear cell interstitial tissue of rats in the first and the second month were also almost similar.

In table 4, the frequency distribution of fibrous tissue in the medulla is shown. The results of this table show that the amounts of fibrous tissue in the medulla in the first and the second months are not different.

### Discussion

The results showed that injection of *Stachys lavandulifolia* Vahl with different concentrations

had toxic effects on renal tubule cells. The toxicity was substantiated after cessation of drugs for 1 month. The results also showed that the toxicity was dose dependent.

The safety profile of this plant in acute, subacute and subchronic tests was determined in Monji et al. (21). To assess the toxicity profile of this extract, female mice were administered the extract by oral gavages in acute (24 hrs), subacute (14 days) and subchronic (45 days) models. All clinical, hematological, biochemical and histopathological changes were assessed in appropriate mid points and end points and compared with control group. Doses up to 140 mg/kg were recognized as maximum tolerated dose in subchronic model. Abnormal changes in kidney and liver weight in treatment groups as well as the significant elevation of biochemical parameters in 45 study days has suggested the possible hepatic and renal toxicity potentials of *S. lavandulifolia* extract with doses upper than 140mg/kg. Doses up 70 mg/kg had no observable adverse effect. Therefore, it was concluded that low doses could be used in clinical trials on the possible therapeutic effects (21).

Phenylpropanoids belonging to the largest group of secondary metabolites is produced by plants, in response to biotic or abiotic stresses such as infections. It is thought that the molecular basis for the protective effect of phenylpropanoids in plants is their antioxidant and free radical scavenging properties. It was determined from other studies that potential safety issues exist if suitable doses of flavonoids and isoflavones were consumed daily. Since the protective effects of Phenylpropanoids on the liver and kidney (22-24). and nephroprotection by flavonoid, epigallocatechin gallate and phenolics, propyl gallate and nordihydroguaiaretic acid, have been demonstrated in mice. (25-27), presumably other compounds are toxic. Phenol ring-containing flavonoids, upon oxidation by peroxidases, yield phenoxyl radicals which are cytotoxic (28-30). Other specific researches are necessary to find out the exact toxic component in this plant. In this regard and based on the results of this study the consumption of this plant should be with caution.

## Conclusion

It must be kept in mind that clinicians should remain cautious until more definitive studies demonstrate the safety, quality and efficacy of *S. lavandulifolia* (31). For these reasons, extensive pharmacological and chemical experiments, together with human metabolism will be a focus for future studies. In this study, we also found that the use of extract can cause side effects in some cases, such as damage to the kidneys, even in some cases, the damage goes far necrosis of renal tissue (32-33).

## Conflict of interest

The author declared no competing interests.

## Acknowledgements

This study was extracted from M.D thesis and supported by the Research Deputy of Shahrekord University of Medical Sciences (grant #813).

## References

- 1-Amin Gh. Popular Medicinal Plants of Iran. Research Department of Health Ministry, Tehran (1991) 49.2-
- 2-Khajehdehi P. Turmeric: Reemerging of a neglected Asian traditional remedy. J Nephropathology. 2012; 1(1):17-22.
- 3-Işcan G, Demirci B, Demirci F, Göger F, Kirimer N, Köse YB, et al. Antimicrobial and antioxidant activities of *Stachys lavandulifolia* subsp. *lavandulifolia* essential oil and its infusion. Nat Prod Commun. 2012 Sep; 7(9):1241-4.
- 4-Basaran AA, Calis I, Anklin C, Nishibe S, Sticher O. Lavandulifolioside: a new phenylpropanoid glycoside from *Stachys lavandulifolia*. Helvetica Chimica Acta 1988; 71(6):1483-90.

- 5-Amin GH. Popular Medicinal Plants of Iran. Tehran: Health Ministry Press; 1991.
- 6-Baradaran A. Lipoprotein(a), type 2 diabetes and nephropathy; the mystery continues. *J Nephropathology*. 2012; 1(3):126-129.
- 7-Saeedi M, Morteza-Semnani K, Mahdavi MR, Rahimi F. Antimicrobial studies on extracts of four species of stachys. *Indian J Pharm Sci*. 2008 May-Jun; 70(3):403-6.
- 8-Rabbani M, Sajjadi SE, Jalali A. Hydroalcohol extract and fractions of *Stachys lavandulifolia* Vahl: effects on spontaneous motor activity and elevated plus-maze behaviour. *Phytother Res* 2005;19(10):854-8.
- 9-Javidnia K, Mojab F, Mojahedi SA. Chemical constituents of essential oil of *Stachys lavandulifolia* Vahl from Iran. *Iranian J Pharm Res* 2004.3: 61–63.
- 10-Delazar A, Delnavazi MR, Nahar L, Moghadam SB, Mojarab M, Gupta A, Williams AS, M. Rahman MM, Sarker SD. Lavandulifolioside B: a new phenylethanoid glycoside from the aerial parts of *Stachys lavandulifolia* Vahl. *Natr. Prod. Res.* (2011) 25(1): 8-16.
- 11-Safaei A. Identification and quantitative determination of luteolin and apigenin in the aerial parts and the extract of *Stachys lavandulifolia* by HPLC. *Iranian J. Pharm. Res.* (2004) 2:suppl. 90-90: 274.
- 12-Nematbakhsh M, Ashrafi F, Pezeshki Z, Fatahi Z, Kianpoor F, Sanei MH, Talebi A: A histopathological study of nephrotoxicity, hepatotoxicity or testicular toxicity: Which one is the first observation as side effect of Cisplatin-induced toxicity in animal model. *J Nephropathology*.2012; 1(3): 190-193.
- 13-Rafieian-Kopaei M, Nasri H, Nematbakhsh M, Baradaran A, Gheissari A, Rouhi H, et al. Erythropoietin ameliorates gentamycin-induced renal toxicity: A biochemical and histopathological study. *J Nephropathology*. 2012;1(2): 109-116.
- 14-Tavafi M. Inhibition of gentamicin-induced renal tubular cell necrosis. *J Nephropathology*. 2012; 1(2): 83-86.
- 15-Kadkhodae M. Erythropoietin; bright future and new hopes for an old drug. *J Nephropathology*. 2012; 1(2): 81-82.
- 16-Rahimi Z. ACE insertion/deletion (I/D) polymorphism and diabetic nephropathy. *J Nephropathology*.2012; 1(3): 143-151.
- 17-Sánchez-Niño MD, Ortiz A. Is it or is it not a pathogenic mutation? Is it or is it not the podocyte? *J Nephropathology*. 2012; 1(3): 152-154.
- 18- Nasri H. Hypertension and renal failure with right arm pulse weakness in a 65 years old man. *J Nephropathology*. 2012; 1(3): 130-133.
- 19-Tolouian R, Hernandez GT. Prediction of Diabetic Nephropathy: The need for a sweet biomarker. *J Nephropathology*. 2013; 2(1): 4-5. DOI: 10.5812/nephropathol.8966.
- 20-Tavafi M. Diabetic nephropathy and antioxidants. *Journal of Nephropathology*. 2(1): 20-27.
- 21-Monji F, Hossein Tehrani H, Halvaei Z, Arbabi Bidgoli S. Acute and subchronic toxicity assessment of the hydroalcoholic extract of *Stachys lavandulifolia* in mice. *Acta Medica Iranica*. (2011)49(12): 769-775.
- 22- Korkina LG. Phenylpropanoids as naturally occurring antioxidants: from plant defense to human health. *Cell Mol Boil*. 2011; 53, 15-25
- 23-Sahni N, Gupta KL. Dietary antioxidants and oxidative stress in predialysis chronic kidney patients. *J Nephropathology*.2012; 1(3): 134-142.

- 24-Kari J. Epidemiology of chronic kidney disease in children. *J Nephropathology*. 2012; 1(3): 162-163.
- 25- Galati G. Dietary flavonoid/polyphenolic reactive metabolites and their biological properties. Toronto: Univ. of Toronto; 2004. [Ph.D. thesis].
- 26-Gheissari A, Mehrasa P, Merrikhi A, Madihi Y. Acute kidney injury: A pediatric experience over 10 years at a tertiary care center. *J Nephropathology*. 2012;1(2): 101-108.
- 27-Ardalan MR, Samadifar Z, Vahedi A. Creatine monohydrate supplement induced interstitial nephritis. *J Nephropathology*. 2012; 1(2): 117-120.
- 28-Galati G, Teng M, Moridani Y, Chan TS, O'Brien PJ. Cancer chemoprevention and apoptosis mechanisms induced by dietary polyphenolics. *Drug Metab. Drug Interact.* 2000; 17: 311-349
- 29-Tayebi Khosroshahi H. Short history about renal transplantation program in Iran and the world: Special focus on world kidney day 2012. *J Nephropathology*. 2012; 1(1) :5-10.
- 30-Galati G, Chan T, Wu B, O'Brien PJ. Glutathione-dependent generation of reactive oxygen species by the peroxidase-catalyzed redox cycling of flavonoids. *Chem Res Toxicol*. 1999; 12: 521-525
- 31- Galati G, Moridani MY, Chan TS, O'Brien PJ. Peroxidative metabolism of apigenin and naringenin versus luteolin and quercetin: glutathione oxidation and conjugation. *Free Radic Biol Med*. 2001; 31: 370-382
- 32-Safaei A. Identification and quantitative determination of luteolin and apigenin in the aerial parts and an extract of *Stachys lavandulifolia* by HPLC. *Iranian J Pharm Res* 2004;2:90-2.
- 33-Tolou-Ghamari Z. Nephro and neurotoxicity, mechanisms of rejection: A review on Tacrolimus and Cyclosporin in organ transplantation. *J Nephropathology*. 2012; 1(1): 23-30.

11/24/2012

**Table1.** Frequency of renal tubular epithelial cell degeneration in rats studied

Dose mg/kg/day	Degeneration of renal tubular epithelial cells					
	First Month			Second Month		
	moderate	mild	No lesion	moderate	mild	No lesion
50	0	6	0	0	0	3
100	0	5	1	0	0	6
150	1	6	0	0	0	9
200	0	7	0	0	2	3
Total	1	24	1	0	2	21

**Table2.** Frequency of necrotic epithelial cells in kidney slices of rats

Dose mg/kg/day	Necrosis of epithelial cells					
	First Month			Second Month		
	moderate	mild	No lesion	moderate	mild	No lesion
50	-	2	6	-	1	2
100	-	2	4	-	4	2
150	-	1	3	-	8	1
200	-	0	2	-	5	0
Total	-	5	15	-	18	5



**Table.3:** Distribution of mononuclear cells in the interstitial tissue slices of rat kidney

Dose mg/kg/day	mononuclear cells in the interstitial tissue					
	First Month			Second Month		
	moderate	mild	No lesion	moderate	mild	No lesion
50	-	0	6	-	-	3
100	-	1	5	-	-	6
150	-	2	5	-	-	9
200	-	0	7	-	-	5
Total	-	3	23	-	-	23

**Table.4:** The frequency distribution of fibrous tissue in the medulla

Dose mg/kg/day	fibrous tissue in the medulla					
	First Month			Second Month		
	moderate	mild	No lesion	moderate	mild	No lesion
50	-	0	3	1	2	0
100	-	2	5	0	3	2
150	-	7	5	0	2	7
200	-	5	5	0	0	5
Total	-	14	18	1	7	14

## Striae Gravidarum in Iranian Women: Prevalence and Associated Factors

Nasim Bahrami<sup>1</sup>, Mohammad Ali Soleimani<sup>2</sup>, Hamid Sharif Nia<sup>3</sup>, Reza Masoodi<sup>4</sup>, Hoorieh Shaigan<sup>5</sup> and Mitra Hekmat Afshar<sup>\*6</sup>

1. Faculty of Nursing and midwifery, Qazvin University of Medical Sciences, Qazvin, Iran and PhD Student of Reproductive Health, Shahid Beheshti University of Medical Sciences, Tehran, Iran.
2. Qazvin University of Medical Sciences, Qazvin, Iran and PhD Student of Nursing and midwifery, Tehran University of Medical Sciences, Tehran, Iran.
3. Faculty of Nursing and midwifery of Amol, Mazandaran University of Medical Sciences, Sari, Iran and PhD Student of Nursing at Baqiyatallah University of Medical Sciences, Tehran, Iran.
4. faculty of Nursing and midwifery, Shahrekord university of Medical Sciences, Shahrekord, Iran and PhD student of nursing, Ahvaz University of Medical Sciences, Ahvaz, Iran.
5. Faculty of Nursing and midwifery, Guilan University of Medical Sciences, Langroud, Iran.
6. Msc of critical care Nursing, Golestan University of medical sciences, Gorgan, Iran (Corresponding Author)  
Email: [m.hekmatafshar@yahoo.com](mailto:m.hekmatafshar@yahoo.com)

**Abstract:** Striae gravidarum (SG) is one of the most common connective tissue changes during pregnancy that may be causing concerns. The purpose of this study was to identify associated factors with striae gravidarum (SG) in pregnant women and their possible association with the characteristics of themselves and their newborns. A cross-sectional study of 224 primiparous women delivering at an educational and therapeutic center was conducted. The data were collected via questionnaire and physical examination. The presence, absence, and severity of striae were evaluated by Davey's score. Data were analyzed by using descriptive and analytical statistics (Chi-square test, t test). 81.3 percent of the participants had developed SG. Women who developed SG had gained significantly more weight during pregnancy ( $14.04 \pm 4.5$  vs  $12.2 \text{ kg} \pm 4.6$ ;  $P < 0.02$ ) and had more body mass index ( $23.47 \pm 3.6$  vs  $21.76 \pm 2.8$ ;  $p < 0.002$ ). Family history of striae gravidarum in mother and sister have a significant association with the presence of SG. This study showed that genetic factors (family history striae gravidarum) and physical factors (weight gain during pregnancy and baseline body mass index) may have a very important role in developing striae gravidarum. The result of this study can help physicians to counsel Iranian pregnant women about their associated factors for striae gravidarum.

[Nasim Bahrami, Mohammad Ali Soleimani, Hamid Sharif Nia, Reza Masoodi, Hoorieh Shaigan and Mitra Hekmat Afshar. **Striae Gravidarum in Iranian Women: Prevalence and Associated Factors.** *Life Sci J* 2012;9(4):3032-3037] (ISSN:1097-8135). <http://www.lifesciencesite.com>. 445

**Key words:** pregnancy, striae gravidarum, Associate factors, prevalence

### Introduction:

The most common alteration in connective tissue of pregnant women is Striae gravidarum (SG);(1) that is no serious problem for bodily function, it is a disfiguring lesion that may cause cosmetic concerns in many women (2). SG mostly develop in the third trimester as reddish and slightly depressed streaks and disappear postpartum to leave permanent silvery scars, which are found sometimes over the breasts, thighs, hips and buttocks and commonly on the skin of abdomen.(3-5)

According to the findings of some surveys, although SG tend to occur in maximum skin stretching areas, the degree of striae formation is

not correlated with the extent of body size enlargement during pregnancy. (6) In a study, Salter et al, found a correlation between the presence of striae and pelvic relaxation, a condition that is associated with decreased collagen content. (7)

It is estimated that up to 90% of pregnant women develop SG, even though some research report the prevalence to be as low as 50%. (8) Some suggested risk factors for development of SG include family history, skin type, race, birth weight (BW), baseline body mass index (BMI), age and weight gain are found; but most of these factors have not been confirmed. (3, 9, 10)

In this study, we want to evaluate the prevalence of striae gravidarum and associated factors in Iranian pregnant women who have a genetic background that might be different from previous reports. In addition to some of the previously studied risk factors, factors that affect healthy skin may be associated with striae gravidarum. Therefore, we looked at some factors, not studied in the past that may theoretically affect the risk of developing SG such as water intake, sleeping, bowel movement, fetal gender, and weight. Information of this present study can help physicians and midwives counsel and promote health care for pregnant women, and may lead to a better understanding of etiology of striae gravidarum with a possible cure.

### Materials and Methods

A cross-sectional study was conducted on 224 women who had given first birth and attended to the postpartum wards of Kosar Hospital, Qazvin, Iran in September - October 2011. The main aim of this study was the calculation of sample size for the prevalence of striae gravidarum. We carried out a pilot study on 50 primiparous postpartum women. With the prevalence of 79% of presence of striae gravidarum, and with the acceptable error of 5%, the sample size was 224.

We excluded the pilot samples from the study. After obtaining written consent to participate in the study, all eligible participants were assessed during the postpartum period before their discharge from the hospital. The exclusion criteria included women with a history of diabetes mellitus, gestational diabetes and multiple pregnancies. The Data were collected via questionnaire and physical examination.

There were three categories of general data in our questionnaire including socioeconomic and some interesting history (age, first degree family history of striae, water drinking habit, sleep hours, smoking, bowel movement, onset of striae, baseline body mass index, Skin type), pregnancy data (gestational age at birth, fetal birth weight, fetal gender, weight gain during pregnancy), and use of cosmetic products (cream, lotion, or oil) to prevent striae (frequency and regularity of applying).

Socioeconomic status was determined based on the third party as low, moderate, and high socioeconomic status. Family history of SG was considered positive if the woman's mother and/or sister had developed SG during her pregnancy. The water drinking habit was evaluated by asking about average number of cup of water drinking in each day. One cup was referred to the volume of about

200 ml. Skin type was determined by interview questions based on the Fitzpatrick classification, which is based on how often a person burns and how well they tan when exposed to the sun. (11) Severity of SG was scored by Davey's method. (12) According to this scoring system, each of organs (breast, abdomen, thigh) was divided into four quadrants. Each quadrant was scored 0 for clear skin, 1 for a moderate number of striae and 2 for many striae, giving a total score of 0-8. Physical examinations were carried out after completing the questionnaire by the author (NB). The dependent variables in this study were the presence and absence of striae and the severity of the striae which was measured by Davey's score and the possible predictor with 16 variables. Independent t -test was used to compare all numeric variables within SG positive and negative groups when there was normally distributed continuous variable (tested with one-sample Kolmogorov-Smirnov test). Fisher's exact test and chi-squared test were used to compare the dichotomous characteristics in participants with or without SG where applicable. Some data have been reported as mean  $\pm$  SD where necessary. Significance was set at 0.05.

This study was approved by the ethics committee of Qazvin University of medical sciences in Iran. Informed consent was obtained from all subjects. In return for their participation, women were given a packet of brochures about the postpartum period, breast feeding, and newborn care.

### Results

During the study period, 496 women were admitted to the hospital for delivery. Of these, 224 were eligible for participation in the study. 246 women of them were multiparous, 17 women were discharged before it was possible to approach them, and 9 were not interested in participating in the study. Of the 224 women enrolled in the study, 182 (81.3%) developed SG in at least one of the assessed sites.

Amongst 182 women of positive striae group, 35.6% had striae in more than one site; 32.4% in two sites and 31.8% in more than two sites. 174 women (95.6%) developed SG on the abdomen, 74 (40.6%) developed SG on the breasts, and 110 (60.4%) developed SG on the thighs during their pregnancy. Mean and SD of Davey score in breast, abdomen and thighs were  $1.08 \pm 1.55$ ,  $4.31 \pm 2.21$  and  $1.76 \pm 2.02$  respectively. Maternal age ranged between 13 and 37 years. The majority of the women were between 20 and 25 years of age

(44.2%), and the mean and SD of maternal age were  $22.45 \pm 4.4$  years.

169 cases (75.4%) reported as having first degree family history of striae gravidarum (mother and/or sisters), in which 47 cases (21%), 89(39.7%) and 33 (14.7%) were mother, sisters and mother, and sisters, respectively. The average water intake in these women was  $7.81 \pm 2.9$  cups/ day. All of the women were nonsmokers, and 32(14.3%) were of a low, 154(68.8%) moderate, and 38(17%) socioeconomic status. The average sleep in these women was  $9.09 \pm 1.9$  hours/ day. In the striae group, women reported that the striae began to appear at average gestational age of  $6.82 \pm 1.4$  months. Figure 1 shows the distribution of the began striae in participant. Baseline Body Mass Index ranged from 14.7 to 36.26 kg/m<sup>2</sup> with a mean of  $23.15 \pm 3.5$  kg/m<sup>2</sup>. The predominant skin type in our population was Fitzpatrick II 41 (18.3%), III 162 (72.3%), and IV 21(9.4%).

71 women (31.7%) had used some kinds of cosmetic products such as lotion, cream, or oil during their pregnancy in an attempt to avoid the development of SG, and 5 (2.2%) had used more than 1 cream or lotion. Amongst these women, 39.4% applied it regularly. There was a large variation in the types of creams used. The most commonly used products were olive oil 51(22.8%). Of the 16 variables investigated, 3 variables were family history, maternal weight gain and Baseline Body Mass Index were found to be significantly associated with the presence of SG. No relationship was noted between other variables in this study and the risk of developing SG. These findings are summarized in Table 1 and 2.

### Discussions

Striae gravidarum is a common cosmetic problem, which occurs during pregnancy. The present study provides a clinical assessment of the prevalence and associated factors for striae gravidarum in the cross sectional study of racially homogeneous women. This study is one of the few studies that authors evaluated striae gravidarum in other common sites including thighs, breasts and buttocks, and not only in the abdomen as in previous studies.

The results showed that the prevalence of SG was 81.3%. Among the investigated sites, mean score of Davey's scale in abdomen was more than the other sites. In most studies, the authors reported the prevalence of SG over 50 percent. (5, 8, 13) However, this prevalence in Western countries such as UK (47-52%) (5, 12) and USA (55%)(3) were lower than middle East such as Lebanon

(60%)(8) and Iran (87.7%).(14) The present information shows that racial differences are important factors that may have an impact on the prevalence of SG.

In our study, SG developed in younger women more than the older ones. However, the difference was not statistically significant. On the other hand, in the studies of Osman & Ratre the mean age of women who developed SG was less than women who did not. (8, 15) Durmazlar et al also noted that women with SG had less median age than those with no SG.(16)

Some authors state that, the connective tissue of the young women with more collagen and less cross-linking of collagen is readier to undergo the partial tearing that occurs in response to the stretch associated with striae gravidarum formation. (4, 17) In addition, young skin has less Fibrillin than old one and this deficiency of Fibrillin has a role in the formation of SG. (18)

Much controversy exists in the literature about association of positive family history and SG. Similar to some of the previous studies,(5, 15) we found that the prevalence of SG in Women who had a positive family history of SG was more than those who did not have. There are different reports about the relationship between family history of SG and the risk of their development. Whereas, according to Lerdpientitayakul et al, there was not significant relationship between family history of SG and the risk of its development. (13) Perhaps the explanation is that the quantitative setting of skin collagen is both individual and site specific and the control of this phenomenon relates to genetic. (17)

No correlation was found between cream use and SG development, which is consistent with previous Studies.(13, 15) Whereas, another study found that the use of oil and massage significantly reduced the likelihood of SG development. (12) There are different suggestions for prevention and treatment of SG that have been done, but no successful preventive interventions have been recognized. The nature of our study makes it difficult to draw any conclusion regarding a possible advantage or role of some of the creams utilized.

We also found out that maternal weight gain and BMI were significantly associated with the presence of SG. Some studies have shown that increase in maternal weight gain is associated with the presence of SG. (13, 15) Since the abdominal wall in women with higher pregnancy weight is more stretched, it is associated with a higher risk of SG. According to studies, rapid weight gain during pregnancy is an important factor in stretching or

tearing in the skin and correlating with SG development. (17)

Much controversy exists in the literature about association of water intake and SG. Some of the studies reported that prevalence of SG decreases by higher water intake. (13) Whereas, similar to Ratre's study (15) we found no significant association between water intake and prevalence of SG.

Higher water intake was believed to soak the skin and improve flexibility and elasticity of the skin. Some studies suggested that SG clearly relates to changes in structures that provide the collagen string of skin with its tensile strength, elasticity, flexibility, and reaction force. (7, 9, 18)

The most of women in this study stated that they had the normal bowel movement during pregnancy. There are few studies for the evaluation of relationship between bowel movement and SG. However, Ratre et al showed that no significant relationship exists between constipation and prevalence of SG. (15)

The authors found that baby's higher birth weight and sex were not significantly associated with SG. (5, 13) The present finding is inconsistent with previous studies. Atwal et al stated that the prevalence of SG is higher among mothers who had son rather than mothers who had daughter. (5) However, some authors mentioned that there is no significant relationship between the sex of baby and the prevalence of SG. (13) Thomas & Liston believed that the occurrence of SG was the result of the amount of stretch applied that depends on the size of the baby. (9) The size of the pregnancy content, which mainly relates to the size of the baby, is the factor of rapid skin stretch that results to SG.

Women with lower family income had more prevalence of SG than those with higher family income. (5, 13) In addition, low socioeconomic women may be more likely to get pregnant earlier which is associated with developing of SG. (5) But in our study, the socioeconomic status had no significant association with SG. Perhaps women who have lower socioeconomic status, gain lower weight during pregnancy, which reduces the chance of SG occurrence.

Similar to the Atwal & Osman study, (5, 8) we also found no significant relationship between skin type and severity of SG. On the other hand, Lerdpienpitayakul et al found that the prevalence of SG in women with lighter skin is more than darker skin. (13) Chang, et al, found that non-white women had a greater association with striae than white women.

It seems genetic and mechanical factors are more associated with higher incidence of SG, and type of skin alone cannot determine the severity of SG in women. (3) Unfortunately, our study population was too racially homogeneous to determine any differences with regard to SG risk related to skin type.

#### **Conclusion:**

This study showed that genetic factors (family history striae gravidarum) and physical factors (weight gain during pregnancy and baseline body mass index) may have a very important role in developing striae gravidarum. Pregnant women often request information regarding the risk factors of developing SG and means to prevent their appearance during their prenatal visits. Our findings can help physicians and midwives answer some of these questions when counseling patients about SG. Although some of the factors associated with SG are not modifiable (age and family history), other factors such as weight gain during pregnancy and Baseline body mass index are modifiable. Future research should focus on preventive methods that may reduce the likelihood of SG development. More specifically the prophylactic use of creams and lotions should be further investigated to determine once and for all if these treatments have any benefit.

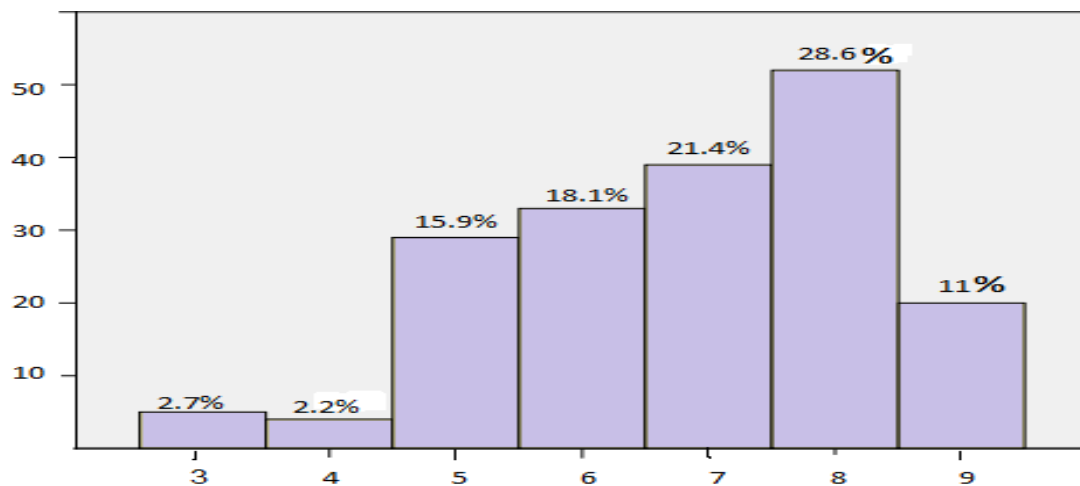
#### **Acknowledgments:**

The authors wish to thank all of the personals of postpartum ward in kosar Hospital for their sincere cooperation during the completion of the research. As well as, we want to recognize the Yasaman Kamyab Mansouri and Fatemeh Mohammadi for data gathering.

#### **References:**

1. Lawley T, Yancey K. Skin changes and diseases in pregnancy. *Fitzpatrick's Dermatology in General Medicine*. 2003;1963-9.
2. McDaniel DH, Ash K, Zukowski M. Treatment of stretch marks with the 585-nm flashlamp-pumped pulsed dye laser. *Dermatologic surgery*. 1996;22(4):332-8.
3. Chang AL, Agredano YZ, Kimball AB. Risk factors associated with striae gravidarum. *J Am Acad Dermatol*. 2004 Dec;51(6):881-5.
4. Cunningham FG, Bloom SL, Leveno KJ. *Williams obstetrics* 23 Ed. New York: McGraw-Hill; 2010.
5. Atwal GS ML, Griffiths CE, Polson DW. Striae gravidarum in primipae. *Br J Dermatol*. 2006;155:965-9.

6. Wade TR, Wade SL, Jones HE. Skin changes and diseases associated with pregnancy. *Obstetrics & Gynecology*. 1978;52(2):233.
7. Salter SA, Batra RS, Rohrer TE, Kohli N, Kimball AB. Striae and pelvic relaxation: two disorders of connective tissue with a strong association. *Journal of Investigative Dermatology*. 2006;126(8):1745-8.
8. Osman H, Rubeiz N, Tamim H, Nassar AH. Risk factors for the development of striae gravidarum. *Am J Obstet Gynecol*. 2007 Jan;196(1):62 e1-5.
9. Thomas R, Liston W. Clinical associations of striae gravidarum. *Journal of Obstetrics & Gynecology*. 2004;24(3):270-1.
10. Wong RC, Ellis CN. Physiologic skin changes in pregnancy. *Journal of the American Academy of Dermatology*. 1984;10(6):929-40.
11. Fitzpatrick TB. The validity and practicality of sun-reactive skin types I through VI. *Archives of Dermatology*. 1988;124(6):869.
12. Davey CM. Factors associated with the occurrence of striae gravidarum. *J Obstet Gynaecol Br Commonw*. 1972 Dec;79(12):1113-4.
13. Lerdpienpitayakul R, Manusirivithaya S, Wiriyasirivaj B, Lorwatthanasirikul J. Prevalence and Risk Factors of Striae Gravidarum in Primiparae. *Thai Journal of Obstetrics and Gynaecology* 2009;17:70-9.
14. Ghasemi A, Gorouhi F, Rashighi Firoozabadi M, Jafarian S, Firooz A. Striae gravidarum: associated factors. *Journal of the European Academy of Dermatology and Venereology*. 2007;21(6):743-6.
15. Ratre JO, Titapant V, Chuenwattana P, Tontisirin P. Prevalence and associate factors for striae gravidarum. *J Med Assoc Thai*. 2008 Apr;91(4):445-51.
16. Durmazlar SPK, Eskioglu F. Striae Gravidarum: Associated Factors in Turkish Primiparae. *J Turk Acad Dermatol*. 2009;3(4):1-5.
17. Shuster S. The cause of striae distensae. *Acta dermato-venereologica Supplementum*. 1979;59(85):161.
18. Watson R, Parry E, Humphries J, Jones C, Polson D, Kielty C, et al. Fibrillin microfibrils are reduced in skin exhibiting striae distensae. *British Journal of Dermatology*. 1998;138(6):931-7.



**Figure 1:** Distribution of the began striae gravidarum in participant base on month of pregnancy

**Table 1.** Antenatal and fetal characteristics and their association with development of striae gravidarum

Characteristic	striae gravidarum		Total (%)	P Value
	Present (%)	Absent (%)		
Family history	yes	147(87)	169(100)	0.001*
	no	35(63.3)	55(100)	
Cream or lotion use	yes	63(88.7)	71(100)	0.06*
	no	119(77.8)	153(100)	
Bowel movement	Constipation	37(86)	43(100)	0.37*
	normal	145(80.1)	181(100)	
Fetal gender	male	87(82.1)	106(100)	0.76*
	female	95(80.5)	118(100)	
Socioeconomic	low	24(75)	32(100)	0.19*
	moderate	130(84.4)	154(100)	
	good	28(73.7)	38(100)	
Skin type	II	31(75.6)	41(100)	0.22*
	III	136(84)	162(100)	
	IV	15(71.4)	21(100)	
Total		81.3(100)	224(100)	

\* Chi square test

**Table 2.** Numeric factors and characteristics of women with and without Striae gravidarum and their newborns

Characteristic	striae gravidarum		Total (%)	P -Value
	Present (%)	Absent (%)		
Maternal Age mean	22.37 ± 4.3	22.83 ± 4.8	22.45 ± 4.4	0.57**
Liquid use mean cup/day	7.97 ± 2.9	7.14 ± 2.7	7.81 ± 2.9	0.08**
Sleep/day	9.07 ± 1.9	9.16 ± 1.8	9.09 ± 1.9	0.77**
Weight gained	14.04 ± 4.5	12.28 ± 4.6	13.71 ± 4.5	0.02**
Body Mass Index	23.47 ± 3.6	21.76 ± 2.8	23.15 ± 3.5	0.002**
Fetal weight	3201.48 ± 394	3138.09 ± 404	3189.59 ± 395	0.36**
Total	81.3(100)	18.7(100)	22491000	

\*\* Independent t test

11/24/2012

## Risk factors of renal stone in patients with recurrent nephrolithiasis: A case-control study

Ali Ghorbani<sup>1</sup>, Heshmatollah Shahbazian<sup>1</sup> and Leila Moradi<sup>2</sup>

<sup>1</sup>Department of Nephrology, Golestan Hospital, Ahvaz Jundishapur University of Medical Sciences

<sup>2</sup>Department of Internal Medicine, Sina Hospital, Ahvaz Jundishapur University of Medical Sciences

**Corresponding Author:** Ali Ghorbani, Department of Nephrology, Golestan Hospital, Golestan Blvd, Ahvaz Jundishapur University of Medical Sciences, Ahvaz, Iran.

Fax: +98 611 374 3013 Tel: +98 611 374 3013 E-mail: [dralighorbani@yahoo.com](mailto:dralighorbani@yahoo.com)

**Abstract:** Renal stone disease is common and caused by a variety of conditions. The overall lifetime rate of renal stone in the general population is approximately 5-12%. The aim of the present study was to determine the prevalence of recurrence rate and metabolic changes present in patients with urinary lithiasis. Patients with renal stone, who attended the nephrology clinics in Ahvaz, Iran, were enrolled into the study. One hundred and forty patients and 60 control cases were recruited to the study. Predominance observed for male gender, with 2.1:1 ratio. There were also 33 men and 27 women in control group. Mean age was  $36.8 \pm 14.3$  and  $40.5 \pm 14.5$  years for patients and control group respectively. Frequency of diabetes mellitus ( $p = 0.90$ ), urinary tract infection ( $p = 0.125$ ) and cystinuria ( $p = 0.181$ ) did not significantly differ among patients and control cases. Mean body mass index, daily fluid intake, serum fasting glucose, potassium, sodium, magnesium, calcium, alkaline phosphates, parathormone and cholesterol show no statistically significant difference between patients and control group. Mean serum BUN, creatinine, phosphorus, uric acid, and triglyceride levels were significantly higher in patients compared to control group. Mean of 24-hour urine volume, excreted sodium, uric acid, and citrate were significantly higher in patients group too. We concluded that evaluation of recurrent stone formers by examining their blood and urine samples, especially 24-hour urine sample, is beneficial to find underlying metabolic disorder.

[Ali Ghorbani, Heshmatollah Shahbazian and Leila Moradi. **Risk factors of renal stone in patients with recurrent nephrolithiasis: A case-control study.** Life Sci J 2012;9(4):3038-3043] (ISSN:1097-8135). <http://www.lifesciencesite.com>. 446

### 1. Introduction

Renal stone disease is common and caused by a variety of conditions (1, 2). The overall lifetime rate of renal stone in the general population is approximately 5-12% (2-5).

Renal colic affects approximately 1.2 million people each year and accounts for about 1% of all hospital admissions worldwide (2-5). It is estimated that almost 40% of stone formers will have a recurrence within 3 years (6-8), and 60% of them experience the third episode within 9 years of first episode (9).

Conditions in which there is low fluid intake, high animal protein intake and alcoholism (10, 11), infections, metabolic disorders such as hypercalcemia (3, 7), hypercalciuria, obesity, and diabetes mellitus are now, known to be associated with increased stone risk (8, 12-17). Now there are

obvious evidences revealed that medical treatment, especially correction of blood and urine disturbances, can reduce stone formation (5). Assessment of hygienic dietetic aspects and diagnosis of potential metabolic changes are factors on which we can interfere, modifying the progression of this pathology that is characterized by high recurrence (11-17). The aim of this study was to determine the prevalence of metabolic disorders in patients with recurrent nephrolithiasis in southwest of Iran.

### 2. Materials and methods

This study was performed in one of the hottest places in Iran, Ahvaz city, where air temperature may exceed 122° Fahrenheit. Patients with renal stone who attended the nephrology clinics in



Ahvaz, were enrolled into the study. Patients receiving medication or diet modification for possible underlying metabolic disorder were excluded. Finally, 140 patients were enrolled into the study. Of referred patients, 60 cases were chosen and adjusted for contributing variables. All of the cases were weighted. Their height was measured and their body mass index (BMI) was calculated. Metabolic evaluation consisted collection of 24-hour urine samples for measuring calcium, magnesium, sodium, phosphorus, citrate, oxalate, uric acid, and cystine. Also serum levels of fasting glucose (FBS), creatinine, uric acid, cholesterol, bicarbonate, phosphorus and parathormone (PTH) were determined. Urinary specific gravity and pH were measured by dipstick. Finally, urine culture was performed to detect urinary tract infection. Renal failure was considered as serum creatinine level higher than 1.4 mg/dL (18-21). Data are presented as the mean  $\pm$  standard deviation or percentage as appropriate. Null hypothesis was tested by one-sample Kolmogorov-Smirnov procedure. Chi-square test with Yates' correction is used for comparisons of dichotomous data. Comparison of mean between the groups is performed using the one sample independent t test. A *p*-value less than 0.05 was considered as significant.

### 3. Results

One hundred and forty patients and 60 control cases were recruited to the study. Predominance

observed for male gender, with 95 men (67.9%) and 45 women (32.1%), ratio: 2.1:1. There were also 33 (55%) men and 27 (45%) women in control group. Mean age was  $36.8 \pm 14.3$  and  $40.5 \pm 14.5$  years for patients and control group respectively. There was no statistically significant difference between mean age of the patients and control group ( $p = 0.823$ ). Familial history of nephrolithiasis was positive in 23.6% of patients, but only was 1.7% in control group ( $p < 0.001$ ). Frequency of diabetes mellitus ( $p = 0.90$ ), urinary tract infection ( $p = 0.125$ ), and cystinuria ( $p = 0.181$ ) did not significantly differ among patients and control cases. Mean body mass index, daily fluid intake, serum fasting glucose, potassium, sodium, magnesium, calcium, alkaline phosphates, parathormone and cholesterol showed no statistically significant difference between patients and control group, as well in mean level of 24-hour urine magnesium, phosphorus, and oxalate (table 1). Mean serum BUN, creatinine, phosphorus, uric acid, and triglyceride were significantly higher in patients compared to control group. Mean 24-hour urine volume, excreted sodium, uric acid were significantly higher in patients group too (table 1). Mean daily urinary citrate was significantly lower in patients group in comparison to control group ( $p = 0.045$ ). Renal failure was found in 10 patients. Hyperuricemia, hyperuricosuria and hypocitraturia were detected in 26 (18.5%), 30 (21.4%), and 83 patients (59.2%) in patients group, respectively.

**Table 1:** Demographic and laboratory data of patients and control group

	Scale	Patients	Control group	p-value
Age	Year	36.8 ± 14.3	40.5 ± 14.5	0.823
BMI	Kg/m <sup>2</sup>	25.6 ± 3.8	26.2 ± 3.1	0.259
Fluid intake	Liter	2.2 ± .5	2.3 ± .5	0.85
Fasting blood sugar	mg/dL	92.4 ± 28.1	97.7 ± 47.7	0.386
Serum potassium	mEq/L	4.2 ± .6	4.2 ± .3	0.319
Serum sodium	mEq/L	140.6 ± 5.2	140.7 ± 3.4	0.895
Serum BUN	mg/dL	16.9 ± 6.1	14.7 ± 4.8	0.006
Serum creatinine	mg/dL	1.03 ± .27	.87 ± .22	<0 .001
Serum magnesium	mg/dL	2.2 ± .3	2.1 ± .3	0.64
Serum phosphorus	mg/dL	3.5 ± .8	4.1 ± .6	<0 .001
Serum calcium	mg/dL	9.4 ± .8	9.5 ± .5	0.244
Serum Uric acid	mg/dL	6.1 ± 1.6	5.4 ± 1.3	< 0.001
Serum PTH	pg/ml	49.9 ± 60.1	48.9 ± 15.9	0.84
Serum alkaline phopsphtase	U/L	197.6 ± 85.7	217.5 ± 66.5	0.078
Serum cholesterol	mg/dL	187.8 ± 48.8	184.4 ± 46.7	0.647
Serum triglyceride	mg/dL	205.5 ± 96.8	159.5 ± 84.4	0.001
24-h urine volume	L/24 h	1647.6 ± 676.4	1409 ± 418.5	0.003
24-h urine protein	mg/24 h	103.2 ± 55.2	151.3 ± 231.8	0.108
24-h urine phosphorus	mg/24 h	595.2 ± 236.7	564.5 ± 134.3	0.247
24-h urine magnesium	mg/24 h	60.2 ± 35.5	68.9 ± 39	0.223
24-h urine sodium	mmol/24 h	152.6 ± 75.2	129.2 ± 41	0.005
24-h urine uric acid	mg/24 h	676.6 ± 624.5	545.6 ± 168.6	0.023
24-h urine oxalate	mg/24h	28.8 ± 37.9	27 ± 40	0.766
24-h urine citrate	mg/24h	407.5 ± 272.7	482.7 ± 226.3	0.045
24-h urine calcium	mg/24	165.3 ± 96.4	131 ± 46.5	0.032

#### 4. Discussion

Better understanding of pathophysiology and applicable therapeutic managements, specific therapies in particular, have increased the importance of evaluation of urolithiasis (1,5). Significance of management of underlying medical disorders come clear regarding this fact that kidney stones have a high recurrence rate. In our study, the most frequent metabolic change in patients who with recurrent stones was hypocitraturia, followed by hyperuricosuria and hyperuricemia.

Marangella et al. found that renal stones induce a clear-cut influence in accelerating the natural worsening of glomerular filtration rate (22). Similarly in showed that patients with urolithiasis had higher serum levels of BUN and creatinine. In our study, patients experienced hyperuricemia and hyperuricosuria, more than control group. It is in concordance with previous studies which demonstrated hyperuricemia and hyperuricosuria as the risk factors for stone formation (23). There is dominancy in plasma triglyceride in patients group compared to control group as mentioned in table 1. Orzaki et al noticed that 24-hour urine volume decreased in 39.7% of patients with recurrent renal stone (24), but in contrast, mean 24-h urine volume was significantly lower in patients group in comparison to control group. We found natriuresis as a risk factor of urolithiasis in 17.8% of patients. It may be a result of high salt diet in Ahvaz city, especially in hot days. Stone risk is greater in those who had hypercalciuria, reported as high as 50% in recurrent episodes (24-26). We found hypercalciuria in 12 (9%) patients. Of them, one had hyperparathyroidism. Genetic, dietary and climate diversity may justify the difference. Similar to our results Mortazavi et al. found that 60% of children with urinary stones had hypercalciuria with unknown origin (27). In contrast to previous studies, rate of hypercalciuria is lower in our patients, maybe due to dietary habits. As discussed earlier, hypocitraturia is the most frequent metabolic changes in our patients. Despite the results found by Mithani et al. in Pakistan (28), many authors noted hypocitraturia as a major risk factor for stone formation (23-29). Pathogenesis of hypocitraturia remained unclear (23, 24, 28, 29). Regarding to the diversity of genetic, dietary and climate factors and the fact that correction of biochemical disturbance can prevent stone formation (30-36), we concluded that the evaluation of recurrent stone formers by examining their blood and urine samples,

especially 24-hours urine sample, is beneficial to find underlying metabolic disorder.

**Acknowledgements:** This study was performed as the residency thesis of Dr. Leila Moradi and supported by a grant from Ahvaz Jundishapur University of Medical Science.

#### References

- 1- Soucie JM, Coates RJ, McClellan W, Austin H, Thun M. Relation between geographic variability in kidney stones prevalence and risk factors for stones. *Am J Epidemiol.* 1996 Mar 1;143 (5): 487- 95.
- 2-Sahni N, Gupta KL. Dietary antioxidants and oxidative stress in predialysis chronic kidney patients. *J Nephropathology.* 2012; 1 (3): 134-142.
- 3-Maghsoudi AR, Baradaran-Ghahfarokhi M, Ghaed-Amini F, Nasri H, Dehghani Mobarakeh M, Rafieian-Kopaei M. Renal failure and sub mental lymphadenopathy in a 68 years old woman. *J Nephropathology.* 2012; 1 (3): 198-201.
- 4-Kalantar E. Minimizing potential resistance among bacteria causing urinary tract infection. *J Nephropathology.* 2012; 1 (1): 11-12.5-Wilson DR, Strauss AL, Manuel MA. Comparison of medical treatments for the prevention of recurrent calcium nephrolithiasis. *Urol Res.* 1984; 12: 39-40.
- 6-Ghorbani A, Ehsanpour A, Roshanzamir N, Omidvar B. Alterations in antibiotic susceptibility of urinary tract infection pathogens. *J Nephropathology.* 2012; 1 (1): 43-48.
- 7-Solati M, Mahboobi HR. Paraoxonase enzyme activity and dyslipidemia in chronic kidney disease patients. *J Nephropathology.* 2012; 1 (3): 123-125.
- 8-Johri N, Cooper B, Robertson W, Choong S, Rickards D, Unwin R. An Update and Practical Guide to Renal Stone Management. *Nephron Clin Pract.* 2010 Jul 2; 116 (3): c159-c171.
- 9-Whalley NA, Martins MC, Van Dyk RC, Meyers AM. Lithogenic risk factors in normal black volunteers, and black and white recurrent stone formers. *BJU Int.* 1999 Aug; 84 (3): 243-8. PMID: 10468714.
- 10-Curhan GC, Willett WC, Rimm EB, Stampfer MJ. A prospective study of dietary calcium and

- other nutrients and the risk of symptomatic kidney stones. *N Engl J Med.* 1993 Mar 25; 328 (12): 833-8.
- 11-Siener R, Ebert D, Nicolay C, Hesse A. Dietary risk factors for hyperoxaluria in calcium oxalate stone formers. *Kidney Int.* 2003; 63 (3): 1037-43.
- 12- [No authors listed]. Consensus conference. Prevention and treatment of kidney stones. *JAMA.* 1988 Aug 19; 260 (7): 977-81.
- 13-Assadi F. The epidemic of pediatric chronic kidney disease; the danger of skepticism. *J Nephropathology.* 2012; 1 (2): 61-64.
- 14-Sakhaee K. Nephrolithiasis as a systemic disorder. *Curr Opin Nephrol Hypertens.* 2008 May; 17 (3): 304-9.
- 15-Ardalan MR, Samadifar Z, Vahedi A. Creatine monohydrate supplement induced interstitial nephritis. *J Nephropathology.* 2012; 1 (2): 117-120.
- 16-Rahimi Z. ACE insertion/deletion (I/D) polymorphism and diabetic nephropathy. *J Nephropathology.* 2012; 1 (3): 143-151.
- 17-Daudon M, Traxer O, Conort P, Lacour B, Jungers P. Type 2 diabetes increases the risk for uric acid stones. *J Am Soc Nephrol.* 2006 Jul; 17 (7): 2026-33.
- 18-Kari J. Epidemiology of chronic kidney disease in children. *J Nephropathology.* 2012; 1 (3): 162-163.
- 19-Baradaran A. Lipoprotein (a), type 2 diabetes and nephropathy; the mystery continues. *J Nephropathology.* 2012; 1 (3): 126-129.
- 20-Nasri H. Sudden onset of acute renal failure requiring dialysis associated with large B-cell lymphoma of colon. *J Nephropathology.* 2012; 1 (3): 202-206.
- 21- Nasri H. Hypertension and renal failure with right arm pulse weakness in a 65 years old man. *J Nephropathology.* 2012; 1 (3): 130-133.
- 22-Marangella M, Bruno M, Cosseddu D, Manganaro M, Tricerri A, Vitale C, et al. Prevalence of chronic renal insufficiency in the course of idiopathic recurrent calcium stone disease: risk factors and patterns of progression. *Nephron.* 1990; 54 (4): 302-6.
- 23-Hess B, Hasler-Strub U, Ackermann D, Jaeger P. Metabolic evaluation of patients with recurrent idiopathic calcium nephrolithiasis. *Nephrol Dial Transplant.* 1997; 12 (7): 1362-8.
- 24-Orakzai N, Hanbury DC, Farrington K. Screening for biochemical abnormalities in urolithiasis patients. *J Ayub Med Coll Abbottabad.* 2004; 16 (2): 60-3.
- 25-Wikström B, Backman U, Danielson BG, Fellström B, Johansson G, Ljunghall S. Ambulatory diagnostic evaluation of 389 recurrent renal stone formers. A proposal for clinical classification and investigation. *Klin Wochenschr.* 1983 Jan 17; 61 (2): 85-90.
- 26-Morton AR, Iliescu EA, Wilson JW. Nephrology: 1. Investigation and treatment of recurrent kidney stones. *CMAJ.* 2002 Jan 22; 166 (2): 213-8.
- 27-Mortazavi F, Mahboobi L. Clinical manifestations and risk factors of urolithiasis in children. *Iranian J Pediatr.* 2007; 17 (2): 129-133
- 28-Mithani S, Zaidi Z. Comparison of 24 hours urinary citrate levels in urolithiasis patients and healthy controls. *J Pak Med Assoc.* 2005 Sep; 55 (9): 371-3.
- 29-Utsui Y, Matsuzaki S, Matsushita K, Shima M. Urinary citrate in kidney stone disease. *Tokai J Exp Clin Med.* 2003; 28 (2): 65-70.
- 30-Gheissari A, Mehrasa P, Merrikhi A, Madihi Y. Acute kidney injury: A pediatric experience over 10 years at a tertiary care center. *J Nephropathology.* 2012; 1 (2): 101-108.
- 31-Gheissari A, Hemmatzadeh S, Merrikhi A, Fadaei Tehrani S, Madihi Y. Chronic Kidney Disease in Children, A report from a tertiary care center over 11 years. *J Nephropathology.* 2012; 1 (3): 159-164.
- 32-Tayebi Khosroshahi H. Short history about renal transplantation program in Iran and the world: Special focus on world kidney day 2012. *J Nephropathology.* 2012; 1 (1): 5-10.
- 33-Tolou-Ghamari Z. Nephro and neurotoxicity, mechanisms of rejection: A review on Tacrolimus and Cyclosporin in organ transplantation. *J Nephropathology.* 2012; 1 (1): 23-30.

34- Rafeian-kopaei M, Baradaran A, Nasri H. Association of hyperparathyroidism with malnutrition and Inflammation in maintenance hemodialysis patients. *Life Sci J.* 2012; 9(3): 1871-8

35-Yousefi P, Firouzifar MR, Cyrus A. Correlation between sacral ratio and primary enuresis. *J Nephropathology.* 2013; 2 (4): 183-187.

36-Einollahi B. Are acquired cystic kidney disease and autosomal dominant polycystic kidney disease risk factors for renal cell carcinoma in kidney transplant patients? *J Nephropathology.* 2012; 1 (2): 65-68.

11/24/2012

## The Effect of Attitudes on Managers Creativity

<sup>1</sup>\*Azita Sherej Sharifi and <sup>2</sup>Maryam Charrakh

<sup>1</sup>Department of Accounting, Nowshahr branch, Islamic Azad University, Nowshahr, Iran

<sup>2</sup>Management Department, Tabarestan Education Institution, Chalous Branch, Iran  
E-mail: B.Charrakh1@gmail.com

\*Corresponding Author: Azita Sherej Sharifi

E-mail: sharifi@iauns.ac.ir and sharifi\_1258@yahoo.com

**Abstract:** The most important principle for organization is permanence and development. Today, for permanence in the stage of competition, creativity is vital and important work [2] one of the effective factors in creativity is manager's organization attitude. One of the unique characteristic of human is his enjoyment from attitude. Human being could rule over the variable and complex environment by his thinking and continuing his life. People think with their especial style about circumstances facts [5] if we acquaint with people's attitude, we can better find how the other think do. This fact will help us to communicate with others and this makes us possible to express our thought as this can be compatible with their attitude. This article studies the relationship between the kinds of attitude and managers organizational creativity in Islamic Azad Universities in Tehran Province. The researcher method was a kind of correlation and collected data and information were done by questionnaire and its results was analyzed by descriptive and inferential statistics and SPSS software was used for test. The results show that the emphasis of the main hypothesis to confirm with two secondary hypotheses, it means, there are meaningful relation between synthetic attitude and functional styles with managers organizational creativity and there are not meaningful relation between analytical, realist idealist thinking styles.

[Azita Sherej Sharifi and Maryam Charrakh. **The Effect of Attitudes on Managers Creativity**. Life Sci J 2012;9(4):3044-3051] (ISSN:1097-8135). <http://www.lifesciencesite.com>. 447

**Keywords:** Attitude Style, Organizational Creativity, Managers

### 1. INTRODUCTION

In educational matters, attention to the attitude has the most important. Because the aim of the education is to give power the person on logical, clear attitude in order to solve the problems and life difficulties and organizing the last experiences and then to get success for the future.

Also in managerial studies, discussion about attitude style, manager's perception methods has earn marked the especial centre to its [1]. Vailez in (1992) expresses in a definition of thinking style: Thinking style is personality behavioural models to appear in organizational activities and work, continually and others to know him by virtue of it. The effective varieties on the forming

of attitude styles to consist of culture, age, sex, the parent's attitude style job [7].

Thinking style is an idea to express about people, things or events. In the other words, it is the reflected feeling of people about one thing [5].

In this article, the aim of attitude style is a tool for compatibility of a person with his environment and doing more activity. It was derived of Harrison and Branson definition. Thinking helps to people to be compatible with the work environment. If managers in an office have a good behaviour with his staff, possibly, the positive attitude will create in them (with regard to supervision and organization). Positive attitude to be caused the compatibility of people with environment, the organization of their work place and it prepares the base of their next behaviours.

About (2002) that, analytic thinking was identifies in it. The people with synthetic attitude style believed each person has especial theory and view point for himself and there are not two people that reality to be the same for them. People with synthetic attitude style to leave an impression on high standard and aims and they have worth attitude to manager and human.

In the role of manager, an organization is seeking for argument and uniformity between people. Functional people often to present much with the nature and speed in success with the others attitude. They, people, do not have long term and the great programs but they intend to be short term and functional thinkers to have step by step approach to the life. Annalistic people apparent are calm, exacting and possibly cold and rarely predictable. They see the world regular and logical. Realistic people intend to have powerful and honesty appearance, their most important strategy is experimental discoveries which are realistic construction [10].

One of the arguments about attitude discussion is creativity. Taylor (1988) says: Creativity is the forming of experiences in organization which is new. Gilford would have known creativity with divergent attitude (to get new approaches for solving problem) a synonymous against convergent attitude to get a correct answer.

Attitude style is a point view to express about people, things or events. In other word, it's reflecting of the kind of people feeling about one thing. [4]

In this article, the aim of creativity is the ability of different ideas in a unique method to have an unusual communication between different ideas [9]. Organizational creativity consists of presentation of thinking, a new design in order to improve the quality or quantity of organization and innovation. Increasing creativity in an organization can be led to the increasing quantity and service quality and reducing costs and

preventing of losing resource, reducing bureaucracy, increasing competition, increasing productivity, motivation and occupational satisfaction in staffers[8]. The business College of Harvard University knows 3 elements of related skills to the area or matter and related skills to motivation and creativity as the main part of creativity. The first element of related skills to the area or subject consist of attitude, knowledge, recognition to the reality, the principle and viewpoint of its subject that this obtains by realist brilliant, Experian and training in its area. Creativity consists of the element and different section. Teresa Amiable, the chancellor of Harvard University of business of college researches canter express about the second principle. It means:

The related skills to creativity: If a person to obtain creativity skills (like the answer of question) he can uses the new method of subject skills or he increases them or he obtains the better method of subject skills or he increases them or he obtains the better methods for their using.

The third element is related skills in motivation which is one of the most parts of creativity and determines that what will exactly do the staffers [3]. Acquaintance of person with attitude style can develop his strategies in decision-making and the question response and it is caused to reduce the false decisions. From the highest level of governmental organizations to the lowest degree of educational staff in an institute to need educational manager with the correct attitude, logical, useful and creativity styles[6].

The aim of this research is to investigate the relationship between the kind of attitude style and the organizational creativity of managers in Islamic Azad University branches of Tehran Province and evaluation and measurement of each variable in this organization.

**TABLE 1: LITERATURE REVIEW OF RESEARCH.**

<b>Researcher(S)</b>	<b>Year</b>	<b>Title</b>	<b>Method</b>	<b>Results, Findings</b>
<b>Zhang</b>	2006	The Study Of Attitude Relation And Creativity In 371 Men(18-19 Years Old)	Regression	Attitude Style Has Direct Relation With Total View Point And Attitude Style Has Negative Relation With Minimum Viewpoint.
<b>Kiong Park &amp; Hipark</b>	2005	The Study Of Relationship Between Science Talent And Attitude Styles In Globe	Regression	The Comparison Of Attitude Styles Can Be The Important Component Of Science Talent.
<b>Chaohoang</b>	2002	The Comparison Of Teachers Attitude Styles And Female And Male Students	Casual-Comparative	Teachers And Female Students Prefer Synthetic And Analytic Style Than His Male Competitor And Also Male Teachers Prefer Synthetic And Pragmatist Style Than Female Teachers.
<b>Mohammad Moghimi</b>	2008	The Study Of Relationship Between Management Compatibility And Attitude Style In Governmental Organizations Managers	Regression	There Are Relationships Between Attitude Styles And Managers Compatibility And In Attitude Styles Many Manager Conducts On Based Pragmatism And Combinational Attitude Style In Management Organization.
<b>Fakhri Al Sadat Hoseini</b>	2007	The Study Of Creative Management Role In An Important Teacher Teaching Method In High School	Case Study	There Are Relationship Between Creative Management And Preparation And Performance Of Teachers Curriculum Design
<b>Zahra Fathi</b>	2006	The Study Of Teacher's Attitude About Female Managers Of Managerial Styles	Case Study	There Are Meaningful Relations Between Attitude Styles And Managers Compatibility. Often High School Female Managers Have Consultative Style And The Other Style Have A Low Ratio.



## 2. RESEARCH HYPOTHESIS

Main hypothesis:

- 1-There are relationship between managers of organizational creativity and the kind of attitude styles.
- 2-There are relationship between managers of organizational creativity and synthetic attitude style.
- 3-There are relationship between organizational creativity and analytic attitude style.
- 4- There are relationship between organizational creativity and realist attitude style.
- 5- There are relationship between organizational creativity and synthetic attitude style.

### A. Materials and Methods

This research is on based the aim of applied type and according to the method of correlation-descriptive statistical universe was formed by all managers of Islamic Azad university branches in Tehran province. According to received statistics, the number of managers who took up in these organizations is 259 subjects that the sample calculated 202 subjects by using Morgan and Korjsi table. The data was collected by questionnaire among samples. The answer of all

dependent and independent variable in questionnaires had selected validity because the view of experts was applied in this field. Alfa Cronbakh coefficient which calculated by SPSS Software is equal 0/91 and calculated the end coefficient for each component is more than 0/7 , so it is concluded that questionnaire has a suitable ending.

### B. Results and Discussion

This article is to intend to investigate the relation of the type of managers' attitude style and its organizational creativity. For this purpose, one main hypothesis and 5 secondary hypothesis was designed. In referential static, for the main hypothesis test from multi regression was used step by step method and correlation coefficient was used for investigating secondary hypothesis .In the main hypothesis was claimed that there is meaningful relation between the kind of attitude styles and managers organizational creativity. The result of correlation coefficient has been done between variables of attitude style and organizational creativity.

**TABLE 2: THE OPPOSITE CORRELATION FOR ORGANIZATIONAL CREATIVITY AND PREDICTED VARIABLE ATTITUDE STYLES.**

Variable	1	2	3	4	5
Organizational creativity	** -0/469	-0/010	** -0/353	-0/003	0/060
Predicted variables					
1-synthetic attitude style	-	** 0/207	* -0/133	-0/044	-0/112
2-Idealist attitude style	-	-	* 0/131	0/031	-0/011
3-Functional attitude style	-	-	-	0/056	* -0/099
4-Analytic attitude style	-	-	-	-	* 0/144
5-Realist attitude style	-	-	-	-	-

P\* < 0/05    p\*\* < 0/01

According to Table Data, the research hypothesis can be investigated.

Main hypothesis: There are relationship between the kind of managers' attitude style and their organizational creativity. The data shows there are meaningful linear relation between dependent variable of organizational creativity and functional and combinational attitude styles but there are not meaningful and linear relation between organizational creativity with synthetic attitude styles, analytic and realist style ( $r=0/353$ ) The most correlation belongs to the positive correlation of organizational creativity with functional attitude style ( $r=0/469$ ).

1-There are meaningful and negative correlation between combinational attitude style with organizational creativity ( $r=-0/469$ ,  $p=0/000$ ).

2-There are not meaningful correlation between synthetic attitude style with organizational creativity ( $r=-0/010$ ,  $p=0/441$ ).

3-There are meaningful and positive correlation between functional attitude style and organizational creativity ( $r=0/353$ ,  $p=0/000$ ).

4-There is not meaningful correlation between realist attitude styles with organizational creativity ( $r=0/003$ ,  $p=0/483$ ).

5-The summary for regression analysis has shown in Table2 in step by step method for predicting creativity on based attitude styles ( $r=0/060$ ,  $p=0/197$ ).

**TABLE 3: THE SUMMERY OF REGRESSION ANALYSIS FOR CREATIVITY PREDICTION ON BASED ATTITUDE STYLES (N=202).**

step	Predicted variable	R	R <sup>2</sup>	$\Delta R^2$	SED
1	Combinational attitude style	0/469	0/220	0/216	24/767
2	Functional attitude style	0/353	0/306	0/299	23/416

The above Table shows the summery of the model

As it is seen, the model in the first step has initiated the score of combinational attitude style and this variable could explain about 0/22 variance away. In the other word, this variance has increased about 57 of variance.

(F) Variance analysis in each two models in %1 level is meaningful. It means: There are meaningful different between two variance of combinational attitude style and functional attitude style in creation of organizational creativity.

**TABLE 4: STEP BY STEP REGRESSION ANALYSIS COEFFICIENT FOR PREDICTION OF ORGANIZATIONAL CREATIVITY ON BASED ATTITUDE STYLES.**

Model	Variance	B	SED	B	t	p
1-	Basic number	250/613	8/746	-	28/655	0/000
	Combinational attitude style	-1/337	0/178	-0/469	-7/512	0/000
2-	Basic number	197/136	13/563	-	14/535	0/000
	Combinational attitude style	-1/224	0/170	-0/430	-7/214	0/000
	Functional attitude style	0/836	0/168	0/296	4/976	0/000

According to above results and F meaningful in variance analysis table and T in above tables, regression equation can be written for model 1 as below:

$$y = a + b_1x_1$$

Which by coefficient substitution in above formula of equation, the prediction of organizational creativity=250/613+ (-1/337) (combinational attitude style).

According to gradient quality in above formula, whatever the rate of combinational attitude style is least, the most quantity will predict for creativity of organization. Also,

according to the model 2 in above table, regression equation as follow:

Organizational creativity=basic quantity + gradient (combination attitude style) +gradient (functional attitude style).

Organizational creativity=197/136+ (-1/224) (attitude style) + (0/836) (fundamental attitude style).

According to the gradient quality, whatever the quantity of combinational attitude style to be the least than functional attitude style, the best components are for prediction of organizational creativity.

According to the results from table 3, the quantity of standard coefficient is related to -

0/469 combinational attitude style and standard coefficient of 0/296 fundamental attitude style shows that combinational attitude style have more effect on organizational creativity ,functionally, and inversely. And in lieu of one unite addition in combinational attitude style to -0/469 amount reduces from organizational creativity and in lieu of one unite addition in functional attitude style to 0/296 amount is added to organizational creativity.

As it is seen, Amount in functional and combinational attitude style is in order 4/974 and -7/512 and this numbers show that correlation between combinational attitude style and organizational creativity is inverse and meaningful and correlation between functional attitude style and organizational creativity is directly meaningful.

### 3. CONCLUSION

This article was presented by 5 components model of Bramson, Herison attitude style (combinational attitude style, synthetic ,functional, analytic, realist) as predicted variable which the results show the main hypothesis claim to be confirm with two secondary hypothesis. It means: There are meaningful relation between combinational attitude style and functional style with managers' organizational creativity and synthetic, realistic and analytic attitude style are not meaningful relationship with organizational creativity. For this viewpoint, it is compatible with Mohammad Moghimi article (2008) which is under the title "The study of relationship between management compatibility and attitude style in governmental organizations and the received results and confirmed hypothesis is the same with their research while this article has been done in educational environment and it is led to improvement of educational development process and it is a factor to develop the educational organization and it will be effective beyond favourable social changes and conscious attempt.

### 4. SUGGESTIONS

Recognition of people's attitude style at the beginning of selection of job is caused to be easy forming toward organization aims. So, it is better the mentioned organization to prepare arguments in this connection.

-It is suggested to pay attention in occupying people in jobs and different positions in functional and combinational attitude style in order to be selected the best people by this way and; however, the strong present and satisfaction of staff to be considered.

-Recognition of managers with functional and combinational attitude styles and encouraging them by giving more freedom and interfering them in decision making which is related to creation of creative place in universities.

-To be acquainting managers with philosophy of organizational creativity, purposes, characteristics and its positive results by celebrations, articles and encouraging managers to collecting information in this connection and its publishing in related publication to the universities.

-Educational courses to be hold for acquainting with the kinds of attitude style for all staff and the suitable condition in an organization to be prepared that all attitude styles to have the development opportunity and its attitude characteristics.

### REFERENCE

- [1] B. [Allan](#), [L. Bernardo](#), [Z. Fang](#). "The Relationship Between Thinking Styles And Level Of Externality: A Study Of Turkish Female Preschool Student Teachers [Social Behaviour And Personality](#)". *An International Journal*, Vol. 36, No. 4, pp. 519-528(10), 2008.
- [2] S. Atashpour, H. Aghaei. "An Assessment of the Thinking Styles of Internet Users", *VII European Conference on Psychological Assessment, Malaga (SPAIN)*, 2004, pp.79-83.
- [3] L. Chao, J. Haung. "Thinking Styles Of School Teachers And University Students In Mathematics", *journal of Psychology* .Vol. 27, No. 12,p. 931, 2002.
- [4] M. Haghghi, "Organizational Behavior Management", Tehran: *Samt Publication*, 2008, pp.109-112.

[5] A. Harrison, R. Bramson. "The Art of Thinking". *Berkley Publishing Group*, 2002, p 53.

[6] A. Hashemi. "The Study of Relationship Between The Kind Of Attitude With High School Managers Creativity In Lamord Province".

PrivateWebsite.Www.Dr\_Hashemi.Com, 2009.

[7] M. Moghimi. "The Study of Relationship Between Thinking And Management In Managers" *Governmental Organizations. Public Management Publication* First Published, 2008, pp. 87-90.

[8] M. Moghimi. "Management and Organization, Research Approaches", Tehran: *Termeh Publication*, 2006, p 185.

[9] M. Kairton. "Creativity at Work". *R&D Management Journal*, Vol, 20, No. 2, pp. 183–184, 2007.

[10] K. Soo, P. Kyung-Hee, C. Ho-Seong. "The Relationship between Thinking Styles and Scientific Giftedness in Korea". *Journal of Secondary Gifted Education*, Vol.16, No.2-3, pp. 87-97, 2005.

11/24/2012

## Comparison of radial basic function (RBF) and Statistica in daily flow forecasting

Mahdi Moharrampour<sup>1</sup> and Mohammad Kherad Ranjbar<sup>2</sup>

<sup>1</sup> Department of civil Engineering, Islamic Azad University, buinzahra branch, Qazvin, Iran

<sup>2</sup> Same technical and vocational training college, Islamic Azad University, Karaj branch, Karaj, Iran  
E-mail: kherad\_m62@yahoo.com

\*Corresponding Author: Mahdi Moharrampour

E-mail: m62.mahdi@yahoo.com

**Abstract.** Two decades with the advent of methods based on artificial intelligence and genetics. Algorithm directly based upon different parameters to predict water engineering is highly developed. Accurate prediction of flow in rivers, always as one of the most important factors in safe and economic design of facilities and structures related to river water has been considered by researchers. In this study, the method of radial basic function RBF and Statistica model, are used to forecast daily river flow in north of Iran and the results of these models are compared with Observed daily values. In this paper using information from the four Station hydrometer from the basin for 18 years, statistics from 1368 to 1386 and after normalization to 75% data for training and 25% data for testing were chosen. The results showed that the ability of the radial basic function RBF model output better than the statistical software.

[Mahdi Moharrampour and Mohammad Kherad Ranjbar. **Comparison of radial basic function (RBF) and Statistica in daily flow forecasting.** *Life Sci J* 2012;9(4):3052-3058] (ISSN:1097-8135).  
<http://www.lifesciencesite.com>, 448

**Keywords:** water resources management, flow forecasting, radial basic function neural network RBF, the statistical software, Gharasoo River.

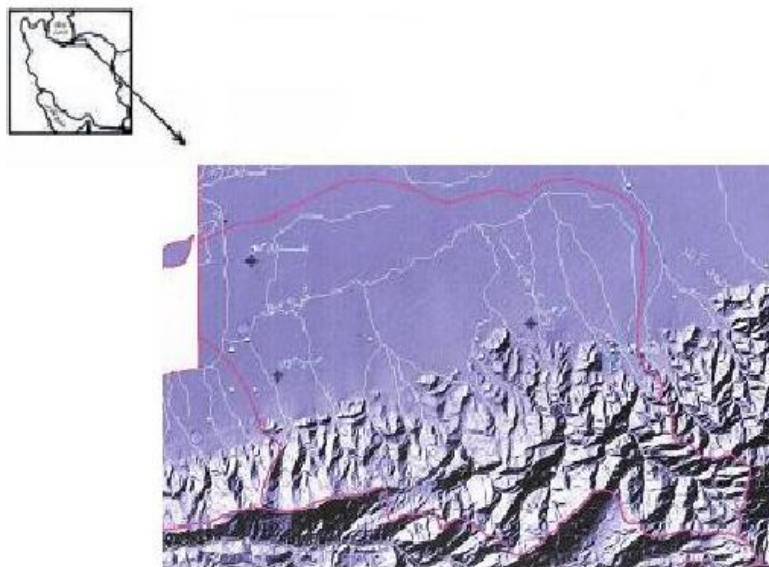
### Introduction:

In recent years, the broader application of Computational Intelligence Computational Intelligence (CI) in solving problems that are very large impact parameters and some physical processes are highly nonlinear relationship between them is governed. Methods based on intelligent use of knowledge lies in the data, trying to extract the intrinsic relationship between them and replicate it in other situations. The most sophisticated methods include artificial neural networks (computing neurons), fuzzy logic (approximate conclusions) and genetic algorithms (calculations mutations), one of the newest and most dynamic areas of research that many researchers are currently in various scientific fields has attracted. On the other hand, one of the important issues in water resources management to the instantaneous flow rate of correct diagnosis, short and long term future and how Dubai is expected to be relying on the accurate prediction than the use of management planning to be

done. In this study, Statistica software was used too for the first time in order to predict the daily discharge. This paper compares two expert models in daily flow forecasting. The RBF neural network and Statistica model, are used to forecast daily river flow in north of Iran and the results of these models are compared with Observed daily values. Gharasoo River is the case study and Gharasoo river data is used for this article.

### Case study area and data

Gharasoo River basin is in Golestan province, northeast of Iran. This basin is located (54) to (54-45) east latitude and (36-36) to (36-59) north longitude. Basin area is 1678.1 km<sup>2</sup>. Maximum height of this basin is 3200 meters from sea level and the length of Main River is 108.005 km. Fig. 1 shows the natural plan and location of Gharasoo River.



**Fig. 1** natural plan and location of GHARASOO River

More than 4 rain measurement stations are existed over this river, but because of lack of statistics for all stations, in this research 4 stations are used. Gharasoo station as exit discharge of this basin and Ziarat,

Shastkalateh and Kordkooy as input of this basin in three different locations.(Table 1)

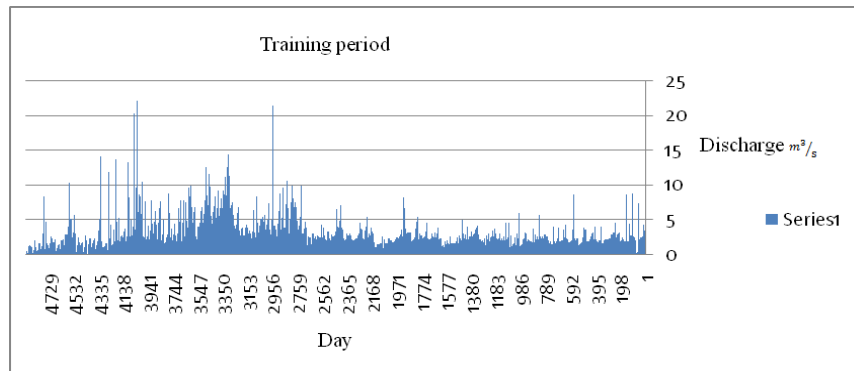
**Table1:** specification of Gharasoo basin stations

Province	Code	Location	River	Longitude	Latitude
Golestan	12-050	Gharasoo	Gharasoo	54-03-00	36-50-00
Golestan	12-043	Naharkhoran	Ziarat	54-28-00	36-46-00
Golestan	12-045	Shastkalate	Shastkalate	54-20-00	36-45-00
Golestan	12-049	Ghaz mahalle(pole jadde)	Kordkooy	54-05-00	36-47-00

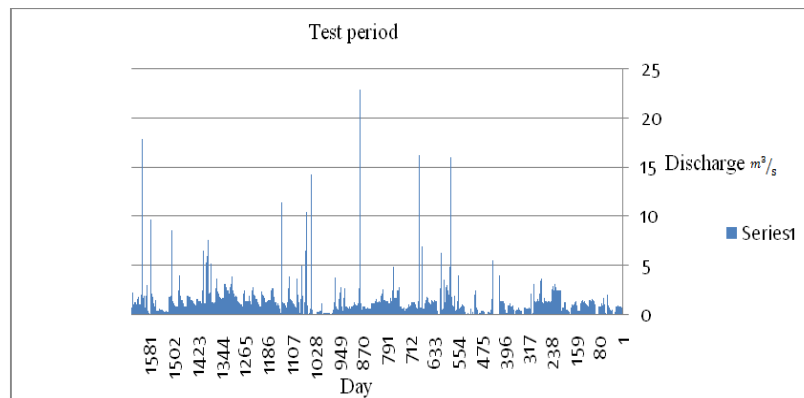
### Preprocessing data

Preprocessing of data includes selection of effective variable, selection of training and test patterns and normalizing the patterns. The goal of normalizing is that all values in one pattern are in a range. Pattern normalizing exchanges all values to a specified interval such as [0-1] or [-1-1].

After normalizing all patterns, period of case study was selected between 1989 to 2007 (18 years).For this period, there are 6550 daily patterns for every station. 75% of these data are used for support vector machine training and 25% of these data are used for test. Fig. 2 shows daily flow hydrograph of Gharasoo River for training period and Fig. 3 shows daily flow hydrograph of Gharasoo River for test period.



**Fig. 2** daily flow hydrograph of Gharasoo River for training period



**Fig. 3** daily flow hydrograph of Gharasoo River for test period

### Designed and developed simulation models using radial basic function neural network software MATLAB

Or Radial Basis Function RBF neural networks are networks with a hidden layer. Gaussian functions is to stimulate them. A neuron has a Gaussian starts with education and training in each iteration a neuron is added to the network. In each iteration a Gaussian added to the network structure and the data is spread. In default on any of the data is Gaussian. I like the fuzzy input space with the Gaussian software, we are. But to achieve the proper answer to this problem and prevent punctures broad Gaussian over fitness level on data from  $10^{-3}$  to increase the amount of output produced increases in the neighboring. The wide experience of over fitness to prevent punctures in the education system for highly trained) Because each data set shows a Gaussian (It does not respond well to test

data. The RBF network and MLP has only one layer parameters can be changed in the maximum number of neurons is 5 that we start to reach a suitable solution, we increase. In all simulations, 75% of completely random data is used for training And the remaining 25% is set aside for network testing.

In the methods of teaching - oriented, the number and type of model input parameters is important. Since the structure of the neural network input, there is a constant and uniform, the results can be presented in the articles will help. Accordingly, the following five input pattern has been studied:



$$\begin{aligned}
 Q(t) &= f\{P_g(t), P_n(t), P_{sh}(t), P_p(t), P_g(t-1), P_n(t-1), P_{sh}(t-1), & -1 \\
 &P_p(t-1), Q_n(t), Q_n(t-1), Q_p(t), Q(t-1), Q(t-1), Q(t-2)\} & -2 \\
 Q(t) &= f\{Q_n(t), Q_n(t-1), Q_p(t), Q(t-1), Q(t-1), Q(t-2)\} & -3 \\
 Q(t) &= f\{P_g(t), P_n(t), P_{sh}(t), P_p(t), P_g(t-1), P_n(t-1), P_{sh}(t-1), & -3 \\
 &P_p(t-1), Q(t-1), Q(t-2)\} & \\
 Q(t) &= f\{Q(t-1), Q(t-2)\} & -4 \\
 Q(t) &= f\{P_g(t), P_n(t), P_{sh}(t), P_p(t), P_g(t-1), P_n(t-1), P_{sh}(t-1), & -5 \\
 &P_p(t-1)\} &
 \end{aligned}$$

In the above Relations:  
 Q :The average daily discharge stations Ghara Soo  
 $Q_n$  :Daily average discharge station dining  
 $Q_p$  :Daily average discharge of Station Road Bridge  
 $P_n$  :The average daily rainfall station dining  
 $P_{sh}$  :The average daily rainfall stations sixty Kalate  
 $P_p$  :The average daily rainfall stations, bridges, roads  
 $P_g$  :The average daily rainfall stations Ghara Soo

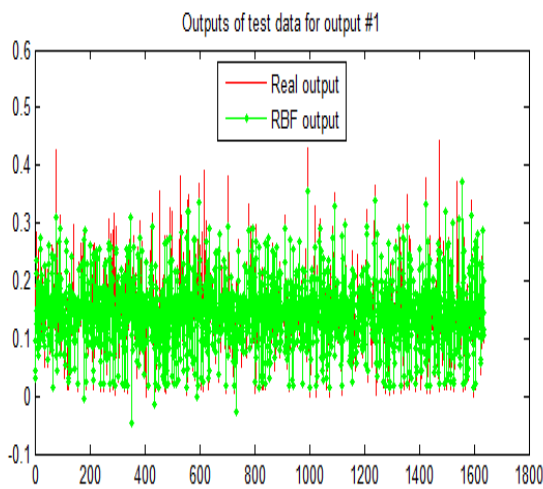
The other patterns were built near each of their results with one of the top models have not gained, and here the expression patterns .

Here is the question raised is which of the five models in the best performance will determine the daily discharge? To answer this question, the input patterns are evaluated .In the present study to compare the performance of models of the correlation coefficient and RMSE R2 is used

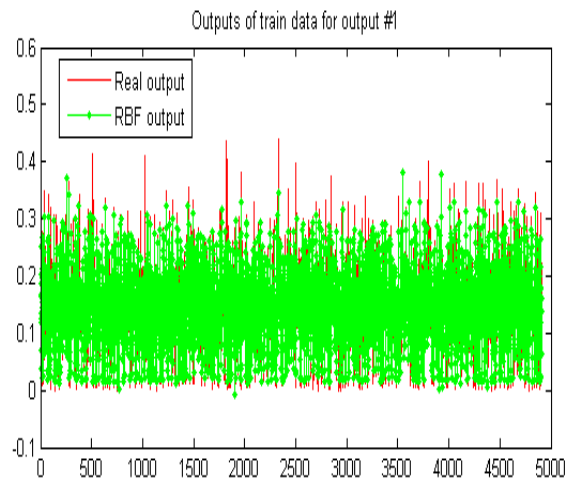
**Table 2:** Summary of results of the RBF neural network performance

Input pattern	A pattern	B pattern	C pattern	D pattern	E pattern
The number of neurons in the input layer	14	6	10	2	8
The number of neurons in the hidden layer	15	5	10	10	15
R2	0.97503	0.97141	0.97521	0.97538	0.85502
RMSE	0.025595	0.027442	0.025142	0.025495	0.061629

What the tables (2) can be concluded that the model is trained for a while to predict the proper discharge of the river that day. input pattern with the second quarter as the input parameter. Figure (4) and (5) Output network training and testing data shows .



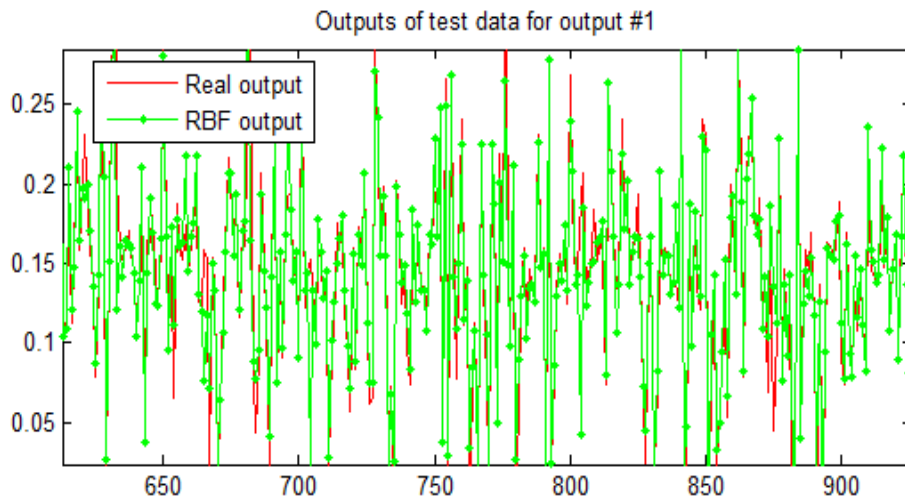
**Figure 4:** Comparison of model outputs in the test phase (first model).



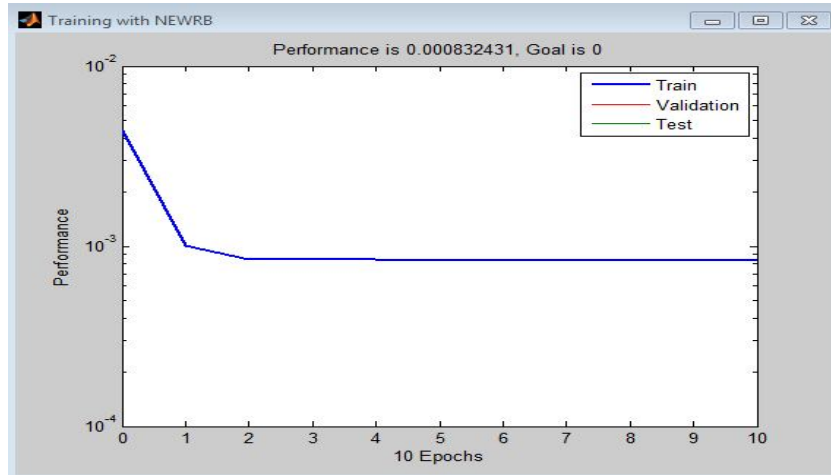
**Figure 5:** Comparison of model outputs in the training phase (first model).

The answer would be better compared with the zoom on the graph (Figure 6). Data is high because the number of graphs can be seen a little sloppy and

messy. The diagram in Figure 7 below you can see how to reduce the network training error:



**Figure 6:** Comparison of model outputs to focus on the test (first model).



**Figure 7:** RMS variation in the number of rounds in the training phase (first model).

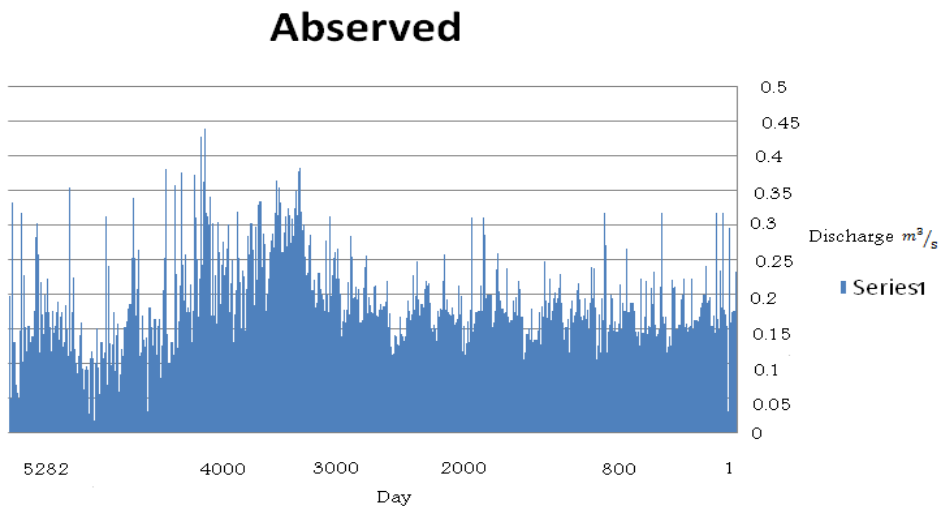
**Predicting the course of the river by using software statistica**

By using the data related to the structure of discharge proposed exit point with the software and statistica had predicted the results with the results of the structure proposed by comparison, svm and just as in the table (3) is determined by the structure proposed by statistica software performance as a result.

**Table 3:** Results of statistica function

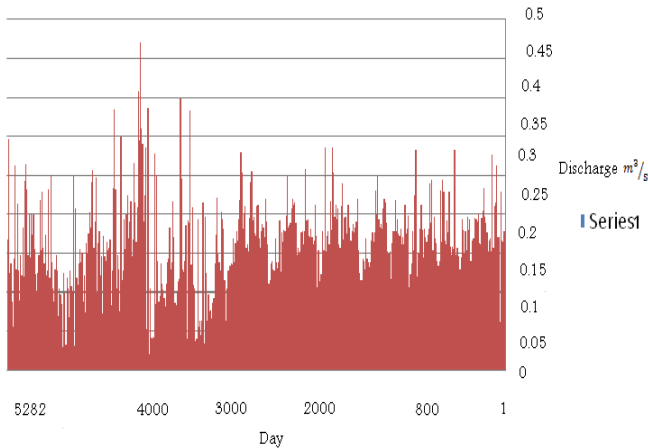
ways	RMSE
statistica	0/095025

Figure 8 and 9 shows the observed discharge and predicted discharge with statistica software. Figure 10 shows the results of both observed and predicted discharge. It shows that predicted maximum discharge is lower than observed discharge[2].

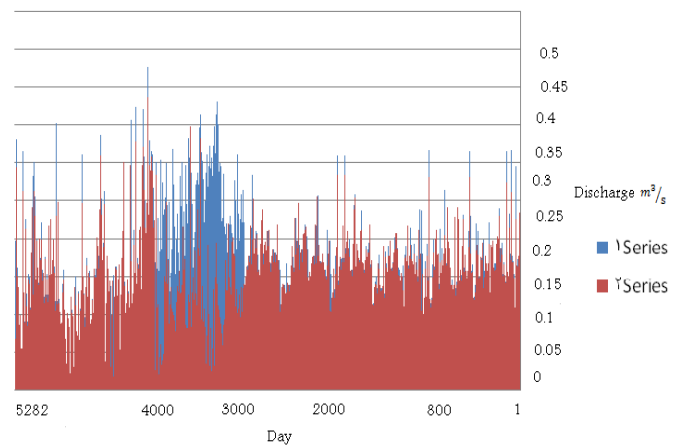


**Fig. 8** Daily discharge hydrograph of Gharasoo Station (Observed)

## Predict



**Fig. 9** Daily discharge hydrograph of Gharasoo Station (Predicted)



**Fig. 10** Daily discharge hydrograph of Gharasoo Station (Observed and Predicted)

### Conclusion

1. 5 input patterns presented, patterns involving Nagorno Station, discharge before and two days before hand, the results were acceptable offer .

2. What the tables (2) can be concluded that the model is trained for the fourth input pattern 2 as input parameters (1-10-2) has More accurate forecasts than other models for daily river discharge do .The result is that a lot of inputs does not necessarily mean it is not anticipated.

3. The prediction of river flow, rainfall and discharge days before and two days before the day of the Station, a major role in the Nagorno-hand plays, so the results can be seen as.

According to what mentioned above, we can say that the radial basic function (RBF) is successful than software STATISTICA.

11/24/2012

### 6. References

[1] Moharrampour .M," Predicted Daily Runoff Using Radial Basic Function Neural Network RBF", Journal of Advances in Environmental Biology, Vol. 6(2): 722-725, 2012. [2] [2]Moharrampour .M," Comparison of Artificial Neural Networks ANN and Statistica in Daily September 2012

## The Impact of CRM Application on Customer Satisfaction in Financial Institutions (Case Study: Financial Institutions in Iran)

<sup>1</sup>Maryam Charrakh and <sup>2\*</sup>Azita Sherej Sharifi

<sup>1</sup>Management Department, Tabarestan Education Institution, Chalous Branch, Iran  
E-mail: B.Charrakh1@gmail.com

<sup>2</sup>Department of Accounting, Nowshahr branch, Islamic Azad University, Nowshahr, Iran.

**\*Corresponding Author:** Azita Sherej Sharifi

E-mail: sharifi@iauns.ac.ir and sharifi\_1258@yahoo.com

**Abstract:** The current business environment is very different from the past and the competition has a special role. In this space, without a doubt the most important factor discrimination between competitors after quality is time and delivery cost of goods or services with added value. The added value occurs through a continuous and stable relationship with the customer. Customer relationship management (CRM) is an important step in creating this value added. CRM as a tool in the hands of banks and institutions is important for communicating with customers and attract and retain them. The main object of study is CRM application impact on customer satisfaction in financial and credit institutions. Method of study is descriptive – analytical and causal analysis and statistical community is customers of financial and credit institutions in Iran (Tehran) and measurement tools is questionnaires. statistical test is Regression analysis After hypothesis testing the was determined that the elements of CRM (quality of service, service features, service availability and system complaints) has an impact on customer satisfaction.

[Maryam Charrakh and Azita Sherej Sharifi. **The Impact of CRM Application on Customer Satisfaction in Financial Institutions (Case Study: Financial Institutions in Iran)**. *Life Sci J* 2012;9(4):3059-3066] (ISSN:1097-8135). <http://www.lifesciencesite.com>. 449

**Keywords:** CRM, Customer Satisfaction, Services, Financial, Credit Institutions

### I. INTRODUCTION

In today's business environment is characterized by increasing competition, more forward fighting is going to win every day. No business, including manufacturing, service and can't be to continue "satisfied and happy customers" stable and able. More important than the demands, an expectation of consumers increased every day and with this trend is growing along. Today, technology has brought systems for business that can help to companies for engage customers and share information. This allows employees retrieve all the information to customers, quickly. This paradigm called customer relationship management system. If it is used properly can increase a company's ability to achieve the ultimate goal that is retaining customers. Thus to achieve a strategic advantage over competitors [15]. Customer relationship management is a strategy that used to gain more information about the needs and behavior and relationships with their customers. Customer good

relations are success keys in business. In other words CRM is constant way to identify satisfy customers and to keep their customers [12]. Now with the advent of credit and financial institutions inside the state banks, we saw an increase in the intensity of competition in the banking industry of Iran. In order he moved to maintain with customer's and creation long term relationships. Because the unfriendly relations with the client's loss of competitive position and will be removed from the scene. Customer Relationship Management as a customer-centric strategy is taken IT-based and increasingly by various companies, including banks and financial institutions and various institutions have invested a lot on CRM. Considering the importance of topic, the goal of this research is to measure the variables following in the study population.

- 1- Measure the dimensions of customer relationship management system
- 2- Measure user's satisfaction of banking services

3- Rating aspects of customer relationship management system in customer view.

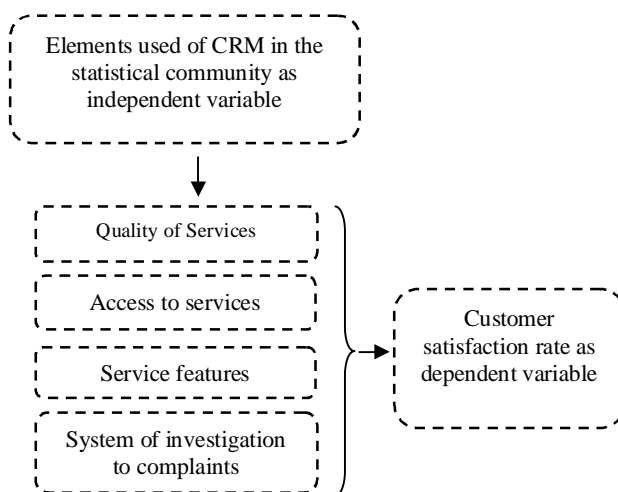
## II. FRAMEWORK RESEARCH

In years past, in our country banking industry, due to various problems of economic, social and to be public and most of all exceeds demand to supply, Elements of the Customer Orientation and the pillars of it has neglected. But with the arrival of private sector banks, the industry gradually takes towards to be the competition [1]. The bank, like any organization, need to improve their relationships with customers and customer satisfaction of services provided, explore to assess customer satisfaction or dissatisfaction of the services received, causes and factors affecting satisfaction, understanding customer expectations and ways to attract customers and meet expectations[8]. Today with the advancement in communication technology salient and the bank's information have turned to new strategy for the deployment of customer relationship management systems. In fact, interest in customer relationship management system has started to grow since 1990s. [15]. Customer relationship management to be included all of processes and technologies. Organizations get to identify, select, promote,

develop, maintain and service the customer. Customer relationship management enables managers because use of customer knowledge to enhance sales, service, Extend it and increase profitability ongoing relations [7].

Customer relationship management is a business strategy focused on the customer that its aims is to increasing customer satisfaction and loyalty through better and more provision of services customized to each customer and respond to them [17]. CRM helps organizations until customer loyalty are evaluated in the repeat purchases, purchase amounts and terms. CRM also helps organizations to respond to these questions: What is an important good service for our customers? How should we communicate with your customer? [9]. the main aim of customer relationship management is simply expression: understand and better behavior with customer in order to increase loyalty and benefits [20]. The main research question is as follows: Do deployment of elements of the system to communicate with customers in private financial and credit institutions in Iran (Tehran) has an impact on customer satisfaction?

Following Analytic chart shows that the dependent and independent variables in this study



**Fig. 1.** Conceptual model for research [16]

**III. CRM**

Customer relationship management is a term used to describe how management is defined as active communication with customers. Customer relationship management is that all components that in organization communicate with the customer and an intelligence way. Customer management processes by support of business technology and operational is technology and roles necessary in order to management clients in various stages of the lifecycle. It is beyond the department, is a separate to a certain level in any organization. A salesperson using CRM in a corner of the country has no need

to access all information relevant to the current position for a client in another corner of the country. However they may need to have access to the customer or a reference until help to conclusion of a deal. Power of related information at the right time is most a distinguishing successful system [5] CRM is part of a strategy to identify and satisfy their customers and become a permanent customer. Also toward customer relationship management assists with the company and in order to maximize the value of each customer [18].

**Table I:** summarizes some of the benefits of Customer Relationship Management [3]

Sharing customer information throughout the organization	Technology innovation, customer relationship management
<ul style="list-style-type: none"> <li>-Increased levels of customer service</li> <li>-Opportunities to sell complementary and valuable products</li> <li>-Extension Information about the characteristics and preferences of customers</li> <li>-Integrity and complete customer point of view</li> <li>-Improving goals of the sector and unique customers</li> <li>-Efficiency of call center / services center</li> </ul>	<ul style="list-style-type: none"> <li>-customer capacity development for Unique service and Internet applications</li> <li>-attract of new customers and Existing by personal relationships and improving goals</li> <li>-Integration of customer and supplier relationships ,to analysis unique and general designs of customer surveys</li> </ul>

**IV. CRM lifecycle**

In Kalakota’s model, CRM is consists of three stages attract, promote and maintain that each step support of

knowledge and understanding of the relationship between organization and customer.

**Table II:** the CRM process and Attention and organizational strategies corresponding them [10]

Stage	focus of Organization	Strategy
Attract	Make distinctive	Innovation
Promote	Make category	Reduce customer service costs
Maintain	Adaptation	Listen to the customer, New supply of products

Market leaders are divided CRM into three areas for example: Dean introduces three layers for determine the complexity of CRM (fig 2).

The first layer of CRM is Operational CRM, which aims to manage all customer contact points (Service, sales and marketing). This Layer is integrated process automation of business. By which, places contact with customer at the front counter (sales, marketing, customer service) are connected through multiple distribution channels and provides integration between the front counter and back counter. (For example, calls sales of automatic data of storage systems, customer billing and customer service)

The second layer is a corporate CRM that to Customers give visual of organization and them with receive update information through organization operating channel; enable to do some affairs of communication with organization. In fact this layer, through corporate inductors (E-mail, conferencing, chat, real-time applications) will facilitate Interaction between company customer and interactions within a company when dealing with customer data (Such as customer service to sales, sales to marketing)

The third layer is analytical CRM. Analytical CRM is created on operational CRM. By using statistical methods and data provides entry section of customer and behavior and knowledge them [16]. This layer contains technologies is that the data received can analyze through interactions with customer. The analyze help to future action that either is beneficial to the customer and the organization. The purpose of data analysis is management of business performance. That deals with analysis, modeling and evaluation of data in data storage, data market or different databases is stored because establish mutually relationship and beneficial between

companies and customers, so CRM is known as and customer-oriented and management approach where information systems, required information is providing for support the operational analytical and participatory processes of CRM and can help to maintain profitability and customer satisfaction [14].

## V. CUSTOMER SATISFACTIONS

The emergence of customer satisfaction at financial institutions has been widely studied and focus on customer satisfaction is the primary goal of any organization, especially bank. Full understanding of this issue is important for researchers and officials [2]. Researchers has found that the impact of a successful business is customer satisfaction. Almost any business cannot continue survive without the consent of the customer. [19] The researchers stressed the importance of customer satisfaction in the banking industry and its role in the maintenance of the client is non-negligible. [6]. Customer satisfaction is a result that is obtained a comparison of actual performance Before buying with expected performance of the client perceived And costs are paid [4]. High level of satisfaction increases customer loyalty, price sensitivity of customers to reduce, costs of marketing failure and create new customers reduce. It reduces operating costs to increase the number of customers. Improves the effectiveness of the ads and increases the firm's credit [11].

Mittal and Kamakura showed the relationship between satisfaction and repeat purchase behavior. The major findings showed that despite same categories the satisfaction based on characteristics of respondents such as age, education, marital status, sex and place of residence no significant difference was observed in repeat buying behavior. This study



suggests consumers have different characteristics, different threshold levels and thus have different probably of repeat purchase. Their Investigate show the impact of demographic factors on relationship satisfaction and loyalty.

Johnson research has been topics consistent (compatibility) in the relationship between satisfaction and loyalty. They stated this topic such that when information is used price and quality similarly and the same in the evaluation of satisfaction and loyalty, relationship between the two constructions is stronger .According to research Auh, if the weight given to information, assessment of satisfaction and loyalty, the same relationship between satisfaction and loyalty is stronger. Consistent theory is effective in explaining the difference between satisfaction and loyalty and it is dependent how to weight the data in the assessment of satisfaction and loyalty, Also will change according the strength of relationship between satisfaction and loyalty [3]. The survey was conducted by the Institute of Strategic Planning in Washington DC showed that return 20% of the investment banks that have been important to their customers requires almost has been double than banks that don't have to pay attention to this subject.

Metawa and almossawi in his research among Islamic banks believe that competence and expertise in Islamic banking is an important factor for success in establishing and maintaining relationships of banks with customers [13].

Molina & etal(2007)survey the effect of long-term customer relationships with their bank and satisfaction. Their results showed ensure customer to bank hasa significant effect on customer satisfaction of bank.

Yuksel& et al (2010) study to recognizing impacts on and customer satisfaction on customer loyalty Structural equation modeling results of this study suggest that thisthe positive feelings of Customer can increase loyalty.

Seeman&O Hara (2006) in the study found that the implementation process of customer relationship management in university cause improve the management process, increased loyalty of students to the university and make satisfied in students .

In research as the impact of CRM on customer satisfaction in agricultural Bank by sarlak and sanaefard (2009) that the dimensions of the customer

relationship management system have the same dimensionsthat was used in this study.These results indicate that dimensions have a positive impact on customer satisfaction.

Jamal & Nasser (2003) about the relationship between service quality and customer satisfaction research was a Pakistani bank and found that this relationship is generally stronger although the relationship did not between customer satisfaction and scale of tangible services.

## VI. RESEARCH HYPOTHESES

### A. Main Hypothesis

Deployment of elements of the system to communicate with customers in private financial institutions and credit in Iran (Tehran) has an impact on customer satisfaction.

### B. Sub-Hypotheses

- 1- Quality of services provided by private financial and credit institutions in Iran (Tehran) has an impact on customer satisfaction.
- 2- Access to services provided by private financial and credit institutions in Iran (Tehran) has an impact on customer satisfaction.
- 3- Service features provided by private financial and credit institutions in Iran (Tehran) have an impact on customer satisfaction.
- 4- System of investigation to complaints provided by private financial and credit institutions in Iran (Tehran) has an impact on customer satisfaction.

## VII. Research Methodology

In terms of methodology and implementation of research is descriptive– analyticaland causal analysis and in terms of type monitoring and degree of control is thefield research. Questionnaire of research is validated because validate or validity of it has confirmed bysupervisors and consultants of faculty. In practice to calculate the reliability coefficient of questionnaire,the first prototype of 20 questionnaire a pre-test. Then, using data obtained was calculated Cronbach's alpha coefficient. Questionnaire to measure the reliability of each variable using Cronbach's alpha coefficient was greater than 70% shows that questionnaire is reliability. Regression method is used to test

research hypotheses also the Friedman test was used to prioritize the variables. In this study, statistical communities are all clients' private financial and credit institutions in Iran (Tehran). In this research, sampling method is cluster. According to the number of financial institutions and credit institutions in Tehran, which is 10 and all of customers are more than 200,000.

### VIII. DATA ANALYSIS

46.3 percent of male respondents and 53.7 percent of respondents are female

63.2% of respondents married and 36.8% of respondents are single.

12.1 percent of respondents under 25, between 26 to 35 years 35.3%, 27.4% between 36 to 45 years, 16.1 percent among 46 to 55 years, 9.2% are older than 55 years.

6.1% of the respondents under diploma, 32.9 percent of respondents diploma, associate degree 16.1 percent, 37.6 percent and 7.4 percent of bachelor's and master's degree and higher.

according to the following table can be said that in main hypothesis the correlation coefficient between the main elements of CRM and customer satisfaction is equal to 0.74 and the coefficient B is equal to 0.98. And considering that the SIG is equal to 0.000. These results indicate that the main research hypothesis is confirmed and CRM elements effect on customer satisfaction. In Sub-hypotheses of study also found that the SIG is less than 0.05 can say with 95% confidence that there search hypothesis is confirmed.

also multiple regression test was performed that according to the results obtained  $R = 0.77$  that shows there is a correlation among the independent variables (Access to services, Service features, System of investigation to complaints, Quality of Services) of study and dependent variables.

**Table III:** Results of the regression testing

Variables	Mean Rank	Chi-Square	df	Asymp. Sig.
Access to services	2.48	163.084	3	.000
Quality of Services	3.13			
System of investigation to complaints	2.35			
Service features	2.03			

**Table IV:** Results of Friedman test

Research hypotheses	R	B	SIG	Hypotheses status
main hypothesis	.744	.988	.000	confirmed
The first sub-hypothesis	.723	.943	.000	confirmed
The second sub-hypothesis	.501	.562	.000	confirmed
The third sub-hypothesis	.646	.736	.000	confirmed
The fourth sub-hypothesis	.726	.780	.000	confirmed

The table can be seen that the most important factor affecting on customer satisfaction are following:

- 1 - Access to Services
- 2 - Quality of Service
- 3 - System of investigation to complaints
- 4 - Feature Services

#### IX. CONCLUSIONS AND SUGGESTIONS

Considering customer relationship management can provide numerous benefits for financial institutions and credit. A customer of banks and financial institutions and credit is equal to at least one asset and by using this approach, retain current customers and encourage them to future reference is re-underlying to their survival for competition that is the main goal every financial and credit institution. According to the results of research can be said that deployment of customer relationship management system that is customer satisfaction and loyalty. And considering the quality, features and service availability as well as complaints system therefore following suggestions for improving the customer relationship management systems are offered:

- Deployment of Employees who have higher speed in offering banking services especially when is caused the overcrowding and also put enough of workforce for behind the counter:
- Create two-way channels between banks and customers.
- Identify hidden needs and expectations of customers and expand the range of services.

- Presence sufficient knowledge of speed into bank operations through presence sufficient knowledge than customers.
- Create work groups or a committee that deal with reviews complaints and requests from customers that are require of time and cost.
- Employee performance and offering bonuses them is based on to meet customer needs and their successful service.
- Measure efficiency and effectiveness unit of customer service and its impact on customer satisfaction and loyalty.
- Be nice decoration and also supplies and forms used by customers and staff cover
- The extent of branches for better service availability
- The use of new technolog

#### References:

- [1] M. Abdolvand, K. Abdoli. "Evaluate affecting factors on customer loyalty of Commerce Bank". *Journal Of Marketing Management*, vol.3, No.5, pp.350-353, 2008.
- [2] A. Arbore, B. Busacca. "Customer satisfaction and dissatisfaction in retail banking: Exploring the asymmetric impact of attribute performances", *journal of retailing and customer services*, Vol.16, pp.271-280, 2009.
- [3] S. Auh, M. Johnson. "Compatibility effects in evaluations of satisfaction and loyalty", *journal of economic psychology*, vol.26, issue1, pp.35-57, 2005.
- [4] J. Beerli Asuncio, Q. Marti. "A model of customer loyalty in the retail banking market" *European journal of marketing*, Vol.38, No.1, p.253-27, 2004.

- [5] J. Meachael. "Customer relationship management, wileycompany", *oxford, United Kingdom*, pp.5-11, 2002.
- [6] J. Farquhar, T. Panther. "Acquiring and retaining customers in UK banks: An exploratory study" *journal of retailing and customer services*, vol.115, pp.9, 2008.
- [7] M. Gholamian, M. khajehafzali. "Knowledge Management in Customer Relationship", *counsel magazine*, vol. 178, No.3, p.37, 2006.
- [8] D. Hoseinihashemzadeh. "Evaluate affecting factors on customer satisfaction of mines and industry", *Journal of Commerce*, Vol.1, no.2, pp.63-82, 2009.
- [9] A. Jamal, k. Nasser. "Factors influencing customer satisfaction in the retail banking sector in Pakistan", *international journal of commerce and management*, vol.13, No. 2, pp. 29-53, 2003.
- [10] J. Johanson, S. Fredrik. "Customer relationship management case studies of five Swedish companies". *Lulealv university of technology*, Available at: [www.epubl.lutb.se/1404-5508/2002/016/index-en.html](http://www.epubl.lutb.se/1404-5508/2002/016/index-en.html)[09,09,2003], 2002.
- [11] M. Kim, C. park, D. Jeong. "The effect of customer satisfaction and switching barrier on customer loyalty in Korean mobile telecommunication services" , *Journal of telecommunication policy*, No.28, pp.148-159, 2004.
- [12] Y. Leo, A. sin, H. Frederick. "CRM, conceptualization and scale development", *European Journal of Marketing*, Vol. 39, pp.1264 – 1290, 2005.
- [13] S. Metawa, M. Almossawi. "Banking behavior of Islamic bank customer: perspectives and implications, international" *journal of bank marketing*, vol.16, No.7, pp.299-313, 1998.
- [14] A. Molina, D. Martin-consuegra, A. esteban. "Relational benefits and customer satisfaction in retail banking", *international journal of bank marketing*, vol.25, No.4, pp.253-271, 2007.
- [15] N. Nguyen. "Strategies for successful CRM implementation" ,*information management & computer security*, vol.15, No.2, pp.102-115, 2007.
- [16] M. Sarlak, F. Sanavi. "the impact of CRM on the satisfaction in agricultural bank", *American journal of economics and business administration*, Vol.1, No. 2, pp.173-178, 2009.
- [17] E. Seeman, M. ohara. "Customer relationship management in higher education using information systems to improve the student-school relationship", *campus-wide information systems*, vol.23, No 1, pp 24-34, 2006.
- [18] E. Turban, E. Mclean, J. Wetherber. "Information Technology for management: Making Connections for Strategic Advantage", 2nd Ed. New York; Wiley, 2002.
- [19] A. Yuksel, F. Yuksel, y. Bilim. "Destination attachment: effects on customer satisfaction and cognitive, affective and cognitive loyalty", *journal of tourism management* vol.31, pp.274-284, 2010.
- [20] H. Zarali, H. kimiloglu. "What signifies success in E - CRM, marketing intelligence & planning", vol.27, No.3, pp 246-247, 2009.

11/24/2012

## Bottom Deformation of Dock Settling Basin on Elastic Foundation

Abolfazl Nazari Giglou<sup>1</sup>, Gita Eynollahi<sup>2</sup>, Taher Nazari Giglou<sup>1</sup>

<sup>1</sup>Civil Engineering Department, Parsabad Moghan Branch, Islamic Azad University, Parsabad Moghan, Iran

[a.nazari.g@iaupmoghan.ac.ir](mailto:a.nazari.g@iaupmoghan.ac.ir)

<sup>1</sup>Geography Engineering Department, Parsabad Moghan Branch, Islamic Azad University, Parsabad Moghan, Iran

**Abstract:** This research studies the deformation computation of bottom of the dock settling basin mainly during the operation period. The bottom of dock settling basin along its length is supposed as a finite bending rigid beam on the ground base. The Fuss-Winkler model is used to compute the variable stiffness coefficient. The basic parameter of this model, i.e. Soil stiffness coefficient, is a non-linear parabolic equation that is accepted along the length of the dock settling basin bottom. This problem is shortened to variable coefficient of ordinary differential equation and is computed by boundary conditions and Maclaurin's series method. After computation of equation, deformation rate and interior forces can be found at any arbitrary cross section of dock settling basin bottom. This article presents a new method of computing the rate and quality of the dock settling basin bottom deformation. The results are compared to the results of the some other researchers.

[Giglou AN, Eynollahi G, Giglou TN. **Bottom Deformation of Dock Settling Basin on Elastic Foundation.** *Life Sci J* 2012;9(4):3067-3072] (ISSN:1097-8135). <http://www.lifesciencesite.com>. 450

**Keywords:** Settling Basin, Operation Period, Fuss-Winkler, Maclaurin's Series, Boundary Condition

### 1. Introduction

Throughout different stages of operation, settling basin structures are subjected to varying loads over very short periods of time. Specifically, rapid changes in loaded can occur during settling basin flooding or dewatering. There are three phases of settling basin operation during which certain specific external loads and load combinations are acting on the settling basin structure: Phase 1: The empty settling basin is dewatering during periods of scouring (Cleaning). During this period the settling basin walls may be loaded by backfill soil, water pressures and by the reaction of the settling basin bottom. The settling basin bottom is loaded by hydrostatic uplift, the reaction of the sub-grade and walls. Phase 2: The settling basin is dewatering but with silt sediments on the settling basin bottom. The external loads may be the same as in Phase 1, but the weight of the silt sediments must be added. Phase 3: the empty settling basin is flooded. The hydrostatic pressures on the settling basin bottom and settling basin walls are added to loads occurring in Phase 1.

Furthermore, in all three operational phases loads from the relevant structure and/or operational mechanical equipment must be added to the aforementioned external loads. The weight of the empty settling basin structure and soil estimated and used in all computing process according to generally accepted methods. The hydrostatic pressure acting on settling basin walls, as well as hydrostatic uplift, depends on the water levels around the settling basin structure and the permeability of the settling basin foundation. For computing the hydrostatic pressures

and the uplift load acting on the settling basin structure, the highest possible water level of the surrounding ground observed over a long period of time is considered. If the base of the settling basin can reach strata in which the groundwater is under pressure, the hydrostatic uplift load is calculated for highest possible static water level. Lateral soil pressure on the settling basin walls are estimated by conventional methods. The type of structure used for the side walls has a major impact on the soil lateral thrust; for example, massive side walls and particularly those rigidly joined with the foundation slab will be exposed to soil pressure "at rest" while flexible walls, or walls that allow for certain movement, will be exposed to active soil pressures.

It is assumed that the dock k settling basin was completely filled with water during the First limit exploitation. There is silt to a specific volume of the dock and the height of the backfill is same as the water height in the dock. In this case the wall and bottom structure of dock settling basin are affected by the forces that were created by different influences. Bottom structure of dock settling basin is affected by hydrostatic pressure of the dock, settled silts weight force and effects on the wall including (hydrostatic pressure, weight force of settling silts, active pressure of backfill, the concrete wall weight force etc.) and the bottom structure is affected by vertical and shearing forces at the initial and ending cross section, pile moment and axial force. Main effects on settling basin cell are shown in figures (1) and (2). Deformation scheme of settling basin bottom structure in this case is shown in figure (3).

Computation of deformation is surveyed by different researchers. C.N. Klepikov (1967) proposed the computation method of deformation of dock settling flexible bottom structure of ship entering sluice. This method, by dividing the non-linear curve of sub-grade stiffness coefficient along the bottom structure length into the special elements, accepts the curve of the each element linear. In general by apply-

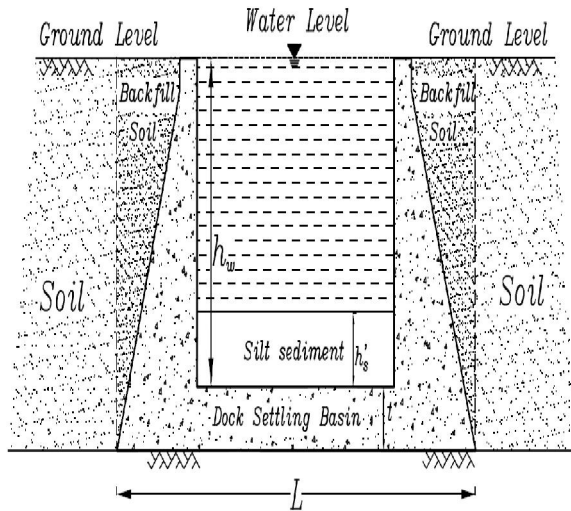


Figure 1. Dock settling basin scheme

ing ultimate element method in finite number the problem is solved to system equation. The solution is generated by using the initial parameters.

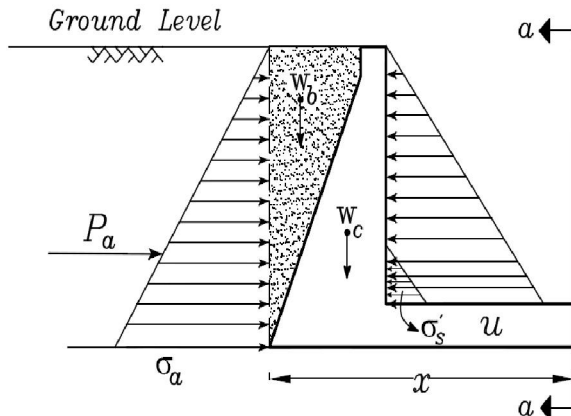


Figure 2. Diagram of forces effect on the dock settling basin

B.A. Kocitcyn (1971) when computing the flexible foundation beams accepted the sub-grade stiffness coefficient non-linear. Foundation stiffness coefficient curve, dependent on the deflection of foundation is accepted convex or concave parabolic. The problem is solved by fourth order differential equation and special boundary conditions. E.A. Simvulidi (1978) offered the deformation

computation method of elastic foundation for engineering structures. In this method the reactive resistance of sub-grade is computed by fourth order polynomial. All of the loads affecting the beam, according to shear function theorem, are substituted for uniformly distributed load and each problem is computed by the fourth order differential equation. The differential soil-structure interaction problems are solved in here. The author in this method mainly used the elastic half-space theory. M.J. Qorbunov-Posadov and others (1984) had done the computation method of flexible beam elements in elastic sub-grade. The author mainly used the elastic half-space theorem. This space generally characterized with the deformation model and Poisson coefficient. The author solved the contact problem by accepting the sub-grade reactive resistance as eighth order polynomial. K.M. Mammadov (2008) performed experiments about deformation computation of flexible sub-grade beams of different geometric forms in finite confined layer. In this method the flexible sub-grade beams with variable stiffness coefficient in the sub-grade is generally solved by fourth order differential equation and infinite series method are mainly used for the solution.

## 2. Definition of Contact Problem

Bottom structure ending transverse sections correspond are affected by the same forces. Bottom structure along its length is affected by the  $q$  distributed load and at the initial transverse section, by the  $M_o$  pile moment,  $Q_o$  Shearing force,  $N$  axial force. Bottom structure is considered as a beam with constant bending stiffness beam on the flexible ground base. Beam Width is considered one meter (in the condition of flatness equation). The bottom structure is supposed as flexible beam because of the bending and tension forces. As the bottom structure is bended by these effects, ground basin reflects reactive resistance against this bending. Fuss-Winkler variable stiffness coefficient model is used to determine the intensity of resistance:

$$q_{qr}(x) = -K(x) \cdot Y(x), \quad (1)$$

where

$K(x)$  is the variable stiffness coefficient along the foundation length.

$Y(x)$  is the bending deformation of the structure at the arbitrary transverse section.

According to the researches carried out by K.M. Mammadov, stiffness coefficient change of structure uniformly-distributed loaded foundation along its length is accepted as a three term quadratic parabola form:

$$K(x) = k_o - \frac{4(K_o - K_c)}{L}x + \frac{4(K_o - K_c)}{L^2}x^2 \quad (2)$$

where

$K_o$  is the stiffness coefficient of initial transverse section of bottom structure ground basin;

$K_s$  is the stiffness coefficient of ground basin at the middle of the beam;

$K_l = K_o$  is the foundation ground stiffness coefficient at the right end transverse section of bottom structure.

In order to compute the tension-bending differential equation of bottom structure we write the bending moment equation at the arbitrary transverse section:

$$M(x) = M_o - Q_o \cdot x - q \cdot \frac{x^2}{2} + N[Y(x) - Y_o] + M_{qr}(x) \quad (3)$$

$M_{qr}(x)$  is the developed moment of ground resistance intensity at the bottom structure arbitrary transverse section. According to the differential relation between deflection and bending moment we write:

$$E \cdot J \frac{d^2 Y(x)}{dx^2} = -M(x) = -M_o + Q_o \cdot x + q \frac{x^2}{2} - N[Y(x) - Y_o] - M_{qr}(x) \quad (4)$$

If we differentiate equation (4) again with respect to (x), so:

$$E \cdot J \frac{d^3 Y(x)}{dx^3} = Q_o + qx - NY'(x) - Q_{qr}(x) \quad (5)$$

According to (4) and (5) equations, E.J is the bottom structure constant stiffness coefficient, and  $Q_{qr}(x)$  is the developed shearing force of the ground reactive resistance at the arbitrary transverse section. If we differentiate again equation (5) with respect to (x):

$$E \cdot J \frac{d^4 Y(x)}{dx^4} = P(x) = q - NY''(x) - q_{qr}(x) \quad (6)$$

where

$P(x)$  is the intensity of the uniformly-distributed load.

If we consider (1) and (2) equations, we can determine  $q_{qr}(x)$  by the following formulas:

$$q_{qr}(x) = \left[ K_o - \frac{4(K_o - K_s)}{L} x + \frac{4(K_o - K_s)}{L^2} x^2 \right] Y(x) \quad (7)$$

If we consider equation (7) in equation (6) and divide all terms into E.J:

$$Y^{IV}(x) = \bar{q} - v^2 Y''(x) - [\alpha_o - \alpha_1 x + \alpha_2 x^2] Y(x) \quad (8)$$

The following conditional denotation is accepted:

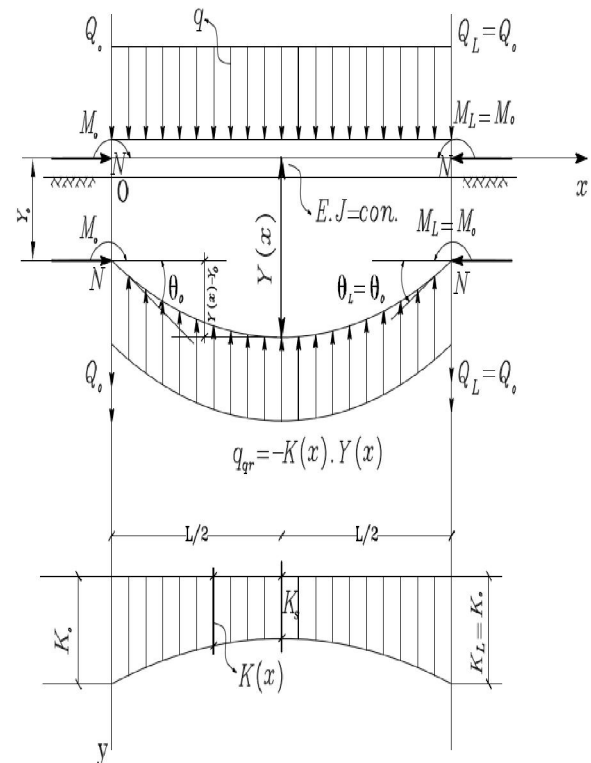
$$\begin{aligned} \bar{q} &= \frac{q}{E \cdot J} [m^{-3}], v^2 = \frac{N}{E \cdot J} [m^{-2}], \alpha_o = \frac{K_o}{E \cdot J} [m^{-4}] \\ \alpha_1 &= \frac{4(K_o - K_s)}{L \cdot E \cdot J} [m^{-5}], \alpha_2 = \frac{4(K_o - K_s)}{L^2 \cdot E \cdot J} [m^{-6}] \end{aligned} \quad (9)$$

We consider differential equation (8) at the bottom structure left initial transverse section by the following boundary conditions:

$$Y(0) = Y_o; Y'(0) = \theta_o; Y''(0) = \frac{M_o}{E \cdot J} = \bar{M}_o; \quad (10)$$

$$Y'''(0) = \frac{Q_o}{E \cdot J} - v^2 \theta_o = \bar{Q}_o - v^2 \theta_o$$

In the last equation deflection ( $Y_o$ ), slope (rotate angle) ( $\theta_o$ ), bending moment ( $M_o$ ) and shearing force ( $Q_o$ ) are the initial parameters at the beginning of bottom structure. (8) equation is an ordinary fourth order differential equation. It can't be solved in quadrature. Different approximate methods are used to solve this equation. The principle methods as the variation methods of structures mechanics, A.N. Krilov numerical computation method, Series method, Picard limit of a sequence method, etc



[1,2,3,4,5,6,7] are used in the computation of this equation. Series method is used in the computation of (8) equation.

Figure 3. Deformation scheme of dock-kind settling basin bottom structure

### 3. Method of Solution

It is very important to use the Series method to compute the (8) equation. If we compute the  $y(x)$  function in the form of the Maclaurin's series, so we write:

$$\begin{aligned} Y(x) &= Y(0) + Y'(0) \frac{x}{1!} + Y''(0) \frac{x^2}{2!} + Y'''(0) \frac{x^3}{3!} + \\ &Y^{IV}(0) \frac{x^4}{4!} + \dots + Y^{(n)}(0) \frac{x^n}{n!} + \dots \end{aligned} \quad (11)$$

The zero values of  $Y(0)$ ,  $Y'(0)$ ,  $Y''(0)$ ,  $Y'''(0)$  are accepted as initial conditions of (8) equation. Four order derivative value of  $Y(x)$  function more than Foru-order, by considering the initial boundary conditions (8) equation, can be computed by consequence differentiating of the (6) differential equation. If we substitute the zero value of all of the derivatives in Maclaurin's series and we group the gained functions according to the four beginning parameters and intensity of uniformly distributed load then we can solve the (8) equation as follow:

$$\left\{ \begin{aligned} Y_0(x) &= Y_0 F_1(x) + \theta_0 F_2(x) - \frac{M_0}{EJ} F_3(x) \\ &+ \frac{Q_0}{EJ} F_4(x) + \frac{q}{EJ} F_5(x) \\ \theta(x) &= Y_0 F_1'(x) + \theta_0 F_2'(x) - \bar{M}_0 F_3'(x) \\ &+ \bar{Q}_0 F_4'(x) + \bar{q} F_5'(x) \\ \frac{M_0(x)}{EJ} &= Y_0 F_1''(x) + \theta_0 F_2''(x) \\ &- \bar{M}_0 F_3''(x) + \bar{Q}_0 F_4''(x) + \bar{q} F_5''(x) \\ \frac{Q^{L_0+q_0}(x)}{EJ} &= Y_0 [F_1'''(x) - v^2 F_1'(x)] \\ &+ \theta_0 [F_2'''(x) - v^2 F_2'(x)] - \bar{M}_0 [F_3'''(x) - v^2 F_3'(x)] \\ &+ \bar{Q}_0 [F_4'''(x) - v^2 F_4'(x)] + \bar{q} [F_5'''(x) - v^2 F_5'(x)] \end{aligned} \right. \quad (12)$$

$F_j(x)$  functions in equations (12) are considered as a rapid converging series sum. In practical computations they might be satisfied by the first two or three continuous series at the right side of the  $F_j(x)$  functions and also the first two or three terms of each series. Convergence series are formed by the small values of parameters at the numerator of each series and also increasable factorial value at the denominator of each series. Approximate derivations of  $F_j(x)$  function at the last three equations of equations (12) can be specified by sequential differentiating with respect to  $(x)$  in these functions. Generally the solution of (12) equations,  $F_1(x)$ ,  $F_2(x)$ ,  $F_3(x)$ ,  $F_4(x)$  and  $F_5(x)$  functions are the four independent special solution, homogeneous independent, of (8) differential equation.  $F_5(x)$  function is a heterogenous special solution of the (8) differential equation. So the unknown functions are specified by using the continuous and rapid converging series. General solution of the contact problem is presented by the initial parameters. In this way it is possible to find the values of unknown parameters easily. According to the formed solution let's consider a special case. It is supposed that the stiffness coefficient of dock kind settling ground basin has an integral mean value: i.e.

$$K_{ave} = \frac{1}{L} \int_0^L k(x) dx = \frac{1}{L} \int_0^L \left[ k_0 - \frac{4(k_0 - k_s)}{L} x + \frac{4(k_0 - k_s)}{L^2} x^2 \right] dx = \frac{(k_0 + 2k_s)}{3} \quad (13)$$

So it is clear that:

$$k_o = k_c = k_l = k_{ave} \Rightarrow \alpha_0 = \alpha_{ave} \text{ \& } \alpha_1 = \alpha_2 = 0,$$

And finally  $F_j(x)$  functions can be written as follow:

$$\left\{ \begin{aligned} F_1(x) &= 1 + \sum_{n=1}^{\infty} (-1)^n \frac{\alpha_{2n}^2 \cdot x^{4n}}{(4n)!} + \\ &\frac{\alpha_{2n}^2}{v^4} \left( 1 - \frac{v^2 x^2}{2!} + \frac{v^4 x^4}{4!} - \cosh vx \right) + \dots \\ F_2(x) &= x + \sum_{n=1}^{\infty} (-1)^n \frac{\alpha_{2n}^2 \cdot x^{4n+1}}{(4n+1)!} \\ &+ \alpha_{2n} \sum_{n=1}^{\infty} (-1)^{n+1} \frac{v^{2n} \cdot x^{2n+5}}{(2n+5)!} (n+1) + \dots; \\ F_3(x) &= \frac{x^2}{2!} + \sum_{n=1}^{\infty} (-1)^n \frac{\alpha_{2n}^2 \cdot x^{4n+2}}{(4n+2)!} \\ &- \frac{1}{v^2} \left( 1 + \frac{v^2 x^2}{2!} - \cosh vx \right) \\ &+ \alpha_{2n} \sum_{n=1}^{\infty} (-1)^{n+1} \frac{v^{2n} \cdot x^{2n+6}}{(2n+6)!} (n+1) + \dots \\ F_4(x) &= \frac{x^3}{3!} + \sum_{n=1}^{\infty} (-1)^n \frac{\alpha_{2n}^2 \cdot x^{4n+3}}{(4n+3)!} \\ &+ \frac{\alpha_{2n}^2}{v^2} \left( vx - \frac{v^3 x^3}{3!} - \sinh vx \right) \\ &+ \alpha_{2n} \sum_{n=1}^{\infty} (-1)^{n+1} \frac{v^{2n} \cdot x^{2n+7}}{(2n+7)!} (n+1) + \dots \\ F_5(x) &= \frac{x^4}{4!} + \sum_{n=1}^{\infty} (-1)^n \frac{\alpha_{2n}^2 \cdot x^{4n+4}}{(4n+4)!} \\ &- \frac{1}{v^4} \left( 1 - \frac{v^2 x^2}{2!} + \frac{v^4 x^4}{4!} - \cosh vx \right) \\ &+ \alpha_{2n} \sum_{n=1}^{\infty} (-1)^{n+1} \frac{v^{2n} \cdot x^{2n+8}}{(2n+8)!} (n+1) + \dots \end{aligned} \right. \quad (14)$$

If the effect of the tension force in the last equation is not considered, i.e. it is accepted that  $v^2 = \frac{N}{E \cdot J} = 0$ ; (14) functions are written in the following form:



$$\left\{ \begin{aligned} F_1(x) &= 1 + \sum_{n=1}^{\infty} (-1)^n \frac{\alpha_{ave}^n \cdot x^{4n}}{(4n)!} \\ F_2(x) &= x + \sum_{n=1}^{\infty} (-1)^n \frac{\alpha_{ave}^n \cdot x^{4n+1}}{(4n+1)!} \\ F_3(x) &= \frac{x^2}{2!} + \sum_{n=1}^{\infty} (-1)^n \frac{\alpha_{ave}^n \cdot x^{4n+2}}{(4n+2)!} \\ F_4(x) &= \frac{x^4}{3!} + \sum_{n=1}^{\infty} (-1)^n \frac{\alpha_{ave}^n \cdot x^{4n+3}}{(4n+3)!} \\ F_5(x) &= \frac{x^4}{4!} + \sum_{n=1}^{\infty} (-1)^n \frac{\alpha_{ave}^n \cdot x^{4n+4}}{(4n+4)!} \end{aligned} \right. \quad (15)$$

Equation (15) is the separation of A.N. Krilov hyperbola-trigonometric function into infinite series. If it is supposed that:

$$\alpha = \sqrt[4]{\frac{\alpha_{ave}}{4}} \text{ or } \alpha_{ave} = 4\alpha^4 \quad (16)$$

The complete solution of equation (8) can be represented as follow:

$$\left\{ \begin{aligned} \bar{F}_1(\alpha x) &= \cosh \alpha x \cdot \cos \alpha x \\ \bar{F}_2(\alpha x) &= \frac{1}{2} (\sinh \alpha x \cdot \cos \alpha x + \cosh \alpha x \cdot \sin \alpha x); \\ \bar{F}_3(\alpha x) &= \frac{1}{2} (\sinh \alpha x \cdot \sin \alpha x); \\ \bar{F}_4(\alpha x) &= \frac{1}{4} (\cosh \alpha x \cdot \sin \alpha x - \sinh \alpha x \cdot \cos \alpha x); \\ \bar{F}_5(\alpha x) &= \frac{1}{4} (\cosh \alpha x \cdot \cos \alpha x) = \frac{1}{4} \bar{F}_1(\alpha x) \end{aligned} \right. \quad (17)$$

Four initial parameters are included in general solution of equations (12).  $M_0$  and  $Q_0$  are considered as known parameters. The next two  $Y_0$  and  $\theta_0$  kinematic initial parameters are specified by the boundary conditions at the right corner of dock kind settling bottom structure. These boundary conditions can be written as follow [6]:

$$\frac{M_n(L)}{E \cdot J} = \frac{M_L}{E \cdot J}, \quad \frac{Q_n^{leng.}(L)}{E \cdot J} = \frac{Q_L}{E \cdot J} \quad (18)$$

According to the last two conditions of equations (12) and by using these conditions we can find:

$$\left\{ \begin{aligned} Y_0 \cdot F_1(L) + \theta_0 \cdot F_2'(L) &= \alpha_1(L) \\ Y_0 \cdot \alpha_2(L) + \theta_0 \cdot \alpha_3(L) &= \alpha_4(L), \end{aligned} \right. \quad (19)$$

Where

$$\left\{ \begin{aligned} M_0 [1 - F_3(L)] - \bar{Q}_0 \cdot F_4'(L) - \bar{q} \cdot F_5(L) &= \alpha_1(L) \\ F_1'(L) - \nu^2 \cdot F_1(L) &= \alpha_2(L) \\ F_2'(L) - \nu^2 \cdot F_2(L) &= \alpha_3(L) \\ M_0 [\nu^2 F_3(L) - F_3'(L)] &+ \bar{Q}_0 [1 - F_4'(L) + \nu^2 F_4(L)] \\ - \bar{q} [F_5(L) - \nu^2 F_5(L)] &= \alpha_4(L) \end{aligned} \right. \quad (20)$$

#### 4. Conclusion

By this method we can compute the deformation of dock settling basin of bottom structure as a flexible beam on the basin ground and also compute the created bending deflection, angular deflection, bending moment and shearing force at the arbitrary transverse section of the bottom structure.

Different researchers considered the different values of bending moments. Those values are compared with the values of bending moment of presented method along the beam lengths (10 m). In figure 4, maximum bending moment value gained by M.J. Qorbunov-Posadov method and minimum value gained by B.A. Kocitcyn method. The maximum bending moment for a simply supported beam under a uniformly distributed load (present study) in comparison to the K.M. Mammadov method is decreasing by (6.04%). In figure 5, maximum shearing force values gained by M.J. Qorbunov-Posadov method and minimum value gained by B.A. Kocitcyn method. The maximum shearing force for a simply supported beam under a uniformly distributed load (present study) in comparison to the M.J. Qorbunov-Posadov method is decreasing by (5.49%).

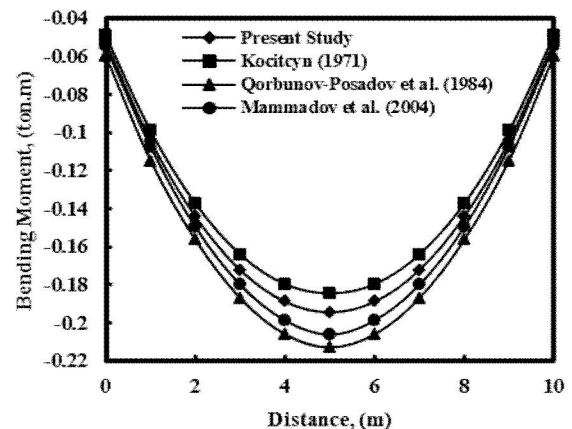


Figure 4. Bending moment curves for a simply supported under a uniformly distributed load

Finally in the offered method, Bending moment and shearing force curves have accordance with the investigation of C.N. Klepikov, B.A.

Kocitcyn, M.J. Qorbunov-Posadov and K.M. Mammadov, but solution of the problem is completely different from those methods.

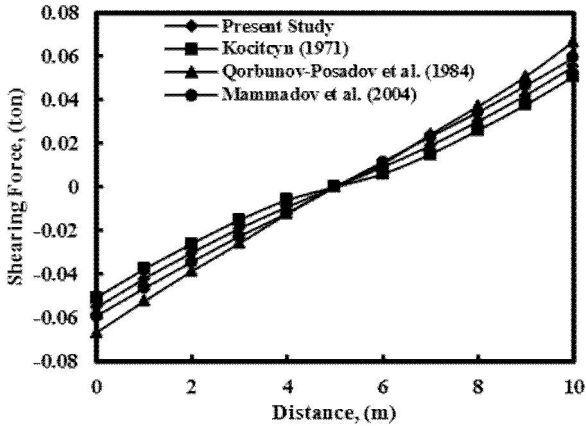


Figure 5. Shearing force curves for a simply supported under a uniformly distributed load

#### Corresponding Author:

Mr. Abolfazl Nazari Giglou  
 Department of Civil Engineering  
 Parsabad Moghan Branch, Islamic Azad University,  
 Parsabad Moghan, Iran  
 E-mail: [a.nazari.g@iaupmogan.ac.ir](mailto:a.nazari.g@iaupmogan.ac.ir)

10/2/2012

#### References

1. Krilov AN. Computation of Beams on Elastic Foundations, Leningrad: Science Academic Press, 1931.
2. Kiselyev VA. Building Mechanics, Special Course (Hydraulic Structures Dynamics and Stabilities), Moscow: Literature Structure Press, 1964.
3. Mammadov KM, Musayev ZS, Mammadov M K. Sea Oil-Gas Mine Hydraulic Structures, Baku: Education NPM Press, 2004.
4. Mammadov KM, Musayev ZS. Hydraulic Structures, Baku: Education NPM Press, 2006.
5. Protusevich YA. Variation Methods of Building Mechanics, Moscow: Dovtech Press, 1948.
6. Prudnikoff AP, Brichkoff YA, Maricheff OE. Integrations and Series, Moscow: Nauka Press, 1981.
7. Bronshteyn EN, Jemendiayev KA. Mathematical Information's for University Students and Engineers. Moscow: Nauka Press, 1981.
8. Qorbunov-Posadov MI, Malikova TA, Solomin VI. Computation of Construction on Elastic Foundation, Moscow: Construction Press, 1984.
9. Simvulidi EA. Computation of Engineering Construction on Elastic Foundation, Moscow: University Press, 1978.

## CXCR4 Expression on Peripheral Blood T-Lymphocytes in Patients with Systemic Lupus Erythematosus and its Relation to Disease Activity

Dina S. Al-Zifzaf<sup>1</sup>, Abir M. Nabil<sup>2</sup>, Rasha Mamdouh<sup>3</sup> and Reem A K khattab<sup>3</sup>

<sup>1</sup>Physical Medicine, Rheumatology and Rehabilitation Department, Faculty of Medicine, Ain Shams University

<sup>2</sup>Physical medicine, Rheumatology and Rehabilitation Department, Faculty of Medicine, Cairo University,

<sup>3</sup>Clinical Pathology Department, Faculty of Medicine, Ain Shams University

[drdvassin@gmail.com](mailto:drdvassin@gmail.com)

**Abstract: Aim:** In this study, we evaluated the expression of CXCR4 on peripheral blood T cells from SLE patients and studied the association between these levels and various clinical and laboratory parameters in order to find out whether SLE patients demonstrated expression abnormalities of CXCR4 to establish if there is a relation between its expression and disease activity in SLE. **Patients and Methods:** This study was conducted on thirty two patients with SLE. All patients were diagnosed according to the 1997 updated American College of Rheumatology (ACR) revised Criteria for diagnosis of SLE. The study also included ten ages and sex matched apparently healthy controls. All patients were subjected to full history taking, thorough clinical examination, assessment of the disease activity according to the modified SLE disease activity index (SLEDAI), SLE cumulative organ damage was scored using the Systemic Lupus International Collaborating Clinics (SLICC) damage index. Routine laboratory investigations were done as well as estimation of CXCR4 expression by flowcytometry on Total Lymphocytes and T-Lymphocytes. **Results:** There was a significant increase in CXCR4 expression on Lymphocytes in general and specifically on T- lymphocytes among SLE patients compared to healthy controls. SLE patients with joint manifestations had significantly lower frequency of expression of CXCR4 on their T cells. On the other hand, patients with serositis had significantly higher levels of expression of CXCR4 on their lymphocytes. Patients with nephritis did not show a significant difference in their chemokine receptor expression as compared to patients without nephritis. Also, no such difference was found regarding the any other clinical or lab characteristic of the patients. A positive significant correlation between T lymphocytes expressing CXCR4 and disease activity measured by the SLEDAI was found. The test validity characters of CXCR4 expression on T lymphocytes for discrimination of SLE at the best cutoff value of 34.6% showed 100% specificity, 87.5% sensitivity and 90.5% efficacy. **Conclusion:** CXCR4 expression levels are elevated on total lymphocytes as well as T cells from SLE patients. This increase in cell expression of CXCR4 correlates positively with disease activity. These findings suggest that CXCR4 hyperexpression may play a vital role in the pathogenesis of SLE, and may after further studies be used as an indicator of disease activity. This also suggests CXCR4 antagonists may halt the role of these cells in the pathogenesis of the disease and improve prognosis for SLE patients.

[Dina S. Al-Zifzaf, Abir M. Nabil, Rasha Mamdouh and Reem A K khattab. **CXCR4 Expression on Peripheral Blood T-Lymphocytes in Patients with Systemic Lupus Erythematosus and its Relation to Disease Activity.** *Life Sci J* 2012;9(4):3073-3079] (ISSN:1097-8135). <http://www.lifesciencesite.com>. 451

**Key words:** Systemic lupus erythematosus, Lymphocytes, T lymphocytes, CXCR4

### 1. Introduction:

Systemic lupus erythematosus (SLE) is a multi-system autoimmune disease that is characterized by the loss of immune tolerance and the production of autoantibodies to nucleic acids and nucleoproteins (Rahman and Isenberg, 2008). Immunopathogenesis of SLE is a complex process that involves the interaction and synergistic effect of various cytokines, chemokines, and signaling molecules which cause the disease activity in SLE (Yu *et al.*, 2012).

T cells have a role in assisting in B cell hyperactivity in lupus by inducing B cell differentiation and facilitating autoantibody production. They also display abnormalities that do not affect B cells directly such as resistance to apoptosis and enhanced signal transduction through

the T cell receptor (TCR) (Chong and Mohan, 2009). Furthermore, there has been growing evidence suggesting that infiltration of T lymphocytes and other leucocytes into the sites of inflammation plays a critical role in organ involvement in SLE (Yu *et al.*, 2012).

The chemokine receptor type 4 (CXCR-4), also known as fusin or CD184 and its ligand CXCL12 belong to a large family of chemoattractant cytokines. These chemokines are also implicated in various biological functions other than chemotaxis, including immunomodulation, angiogenesis, angiostasis, embryogenesis, hematopoiesis, lymphopoiesis, wound healing, cancer, inflammatory disease and HIV-1 pathogenesis (Busihho and Benovic, 2007 and Peled *et al.*, 2012). CXCR4 is expressed in a broad

range of tissues, including immune and the central nervous systems and can mediate migration of resting leukocytes and hematopoietic progenitors in response to CXCL12 functioning in a number of physiological processes. In the immune system, CXCR4 is highly expressed by monocytes, B cells, and naïve T cells in peripheral blood as well as early hematopoietic progenitor cells in bone marrow. Differential expression of CXCR4 in CD34+ progenitor cells may be involved in maintaining hematopoietic progenitor cells in the marrow and regulating stem cell trafficking (Sun *et al.*, 2010). This diverse and crucial role explains why knockout mice of CXCR4 die of hematopoietic, cardiac, vascular and cerebellar defects during embryogenesis (Choi and An, 2011).

Multiple murine lupus strains have demonstrated elevated expression of CXCR4 in peripheral blood leukocyte subsets, and in various immune and non-immune organs. Human studies have yielded conflicting results on CXCR4 levels in peripheral blood leukocytes, particularly on B and T cells, but differences may be due to SLE patient population characteristics and disease activity (Chong and Mohan, 2009).

Given its ability to attract multiple leukocyte subsets and stimulate B cell production and myelopoiesis, recent attention has been directed to CXCR4 and a role of its inhibitors in the treatment of autoimmune diseases, such as systemic lupus erythematosus (SLE) has been proposed (Chong and Mohan, 2009). This was encouraged by the findings of several studies that reported CXCR4 antagonists were able to impede trafficking of leukocytes to peripheral organs in autoimmune diseases. Restricting the leukocytes' ability to enter peripheral organs has significantly hampered disease progression in murine models with various autoimmune diseases (De Klerck *et al.*, 2005 and Kohler *et al.*, 2008). Advances in the understanding of CXCR4 regulation and function and the development of CXCR4 antagonists with different biochemical and pharmacokinetic properties will allow us to safely and fully explore the potential therapeutic benefit of this important axis (Peled *et al.*, 2012).

In order to exploit such an axis and the benefit of development of novel CXCR4-based therapeutics for SLE we must first better understand the role of CXCR4 in this autoimmune disease.

#### **Aim:**

In this study, we evaluated the expression of CXCR4 on peripheral blood T cells from SLE patients and studied the association between these levels and various clinical and laboratory parameters in order to find out whether SLE patients demonstrated expression abnormalities of CXCR4 to

establish if there is a relation between its expression and disease activity in SLE or specific organ damage.

## **2. Patients and Methods**

This study was conducted on thirty two patients with SLE (30 females and 2 males). All patients were diagnosed according to the Updated American Collage of Rheumatology (ACR) revised Criteria for diagnosis of SLE (Hochberg, 1997). Patients attended the outpatient clinic of the Physical medicine, Rheumatology and Rehabilitation departments, Ain Shams and Cairo University hospitals. The study also included ten age and sex matched apparently healthy controls.

Patients with other rheumatic diseases and nephritis due to other causes were excluded from the study.

All patients were subjected to the following:

- I- Full history taking.
- II- Thorough clinical examination was performed on each patient with special emphasis on symptoms and signs of renal affection and clinical parameters of disease activity.
- III- Assessment of the disease activity of SLE patients according to the modified SLE disease activity index (SLEDAI) (Bombardier *et al.*, 1992).
- IV- The SLE cumulative organ damage was scored using the Systemic Lupus International Collaborating Clinics (SLICC) damage index (Gladman *et al.*, 1996).
- V- Routine laboratory investigations including:
  - Complete blood picture by Coulter counter (Coulter Microdiff 18, Fullerton, CA, USA).
  - Erythrocyte sedimentation rate by Westergren method.
  - Serum Anti nuclear antibody (ANA) assessment by indirect immunofluorescence by the Kallestad kit.
  - Serum anti double stranded DNA (dsDNA) and anti single stranded DNA (ssDNA) antibodies were measured using ELISA technique (ORGENTEC).
  - Complement level assessment: C3 immunoglobulin by the Synchron apparatus.
  - Renal function tests including serum creatinine, blood urea, creatinine clearance and routine microscopic urine analysis for presence of pyuria, hematuria and casts. Twenty four hours urine was collected to assay protein.
- VI- Estimation of CXCR4 expression by flowcytometry:

Two mL of venous blood were collected in EDTA- vacutainers for complete blood count and flowcytometric analysis of CXCR4 on CD3+lymphocytes.

It was performed by direct immunofluorescence using Coulter EPICS XL flow cytometer system equipped with 488nm air-cooled Argon Laser. Dual staining was done using fluorescein isothiocyanate (FITC) conjugated CD3 and Phycoerythrin (PE) conjugated CXCR4 (Immunotech, Coulter, CA, France). Ten  $\mu$ l of each of conjugated monoclonal antibody was added to 100  $\mu$ l of EDTA- treated blood. Incubation with monoclonal antibodies was done for 30 minutes at RT in the dark. Two ml of ammonium chloride lysing solution (Al-Gomhoreya CA, Egypt) were then added and mixed thoroughly to lyse peripheral blood erythrocytes. The tubes were further incubated for 5–10 minutes at room temperature in the dark, followed by centrifugation at 3000 rpm for 5 minutes. The supernatants were removed and cells were washed with phosphate buffered saline (PBS). After two washes, the cells were resuspended in 500  $\mu$ l PBS and analyzed by flow cytometry. Lymphocytes were selected in the forward scatter vs side scatter dot plot and additionally gated as CD3 positive cells. Data were represented as the percentage of cells double-positive for CD3 (pan T-lymphocytes marker) and the chemokine receptor CXCR4. Isotypic matched monoclonal antibodies were used as negative control. A minimum of 1000 cells were collected. MFI of CXCR4 was collected and recorded.

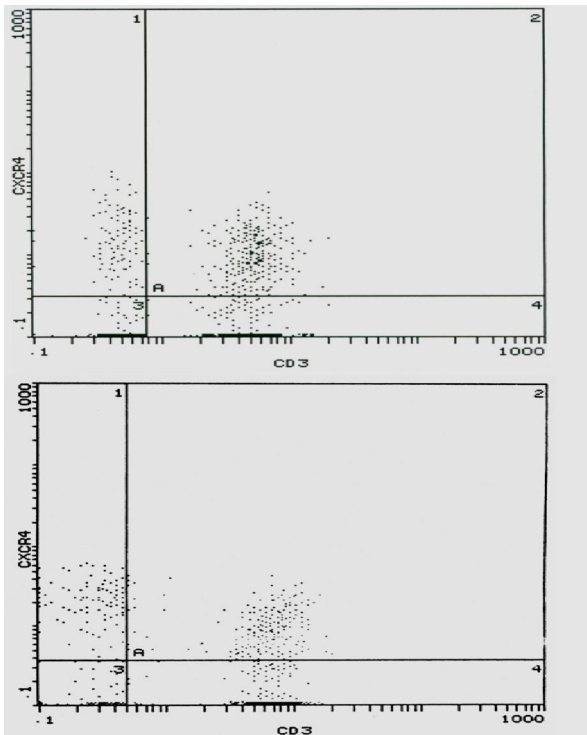


Figure 1: Dot plots histograms of samples of a SLE patient (top) and a control subject (bottom).

VII- Radiological studies including plain X-ray of the chest, affected joints and echocardiography when needed.

VIII- Statistical analysis was done using statistical software package "SPSS" version 10. The descriptive data for quantitative data were expressed as ranges, mean, standard deviation (SD) and numbers and percentages for qualitative data. Student's t test was used to compare between two independent means, and Pearson's correlation coefficient, for relationship between different variables in the same group. Diagnostic validity test including sensitivity, specificity, negative and positive predictive values were calculated. P value <0.05 was considered significant and p<0.01 was considered highly significant.

### 3. Results

#### Demographic, clinical and laboratory characteristics of patients:

Thirty two SLE patients (30 females and 2 males) were included in this study in addition to 10 healthy subjects as a control group matched to both age and sex. The age of the patient group ranged from 18 - 52 years with a mean of  $28.94 \pm 9.6$  years. The disease duration ranged from 2 to 96 months with a mean of  $40.9 \pm 29.9$  months. The mean age of onset was  $24.8 \pm 7.9$  years. The clinical findings in SLE patients are shown in table (1).

**Table (1):** Frequency of various clinical presentations in SLE patients

Clinical manifestations	Number of patients (frequency)	Percentage (%)
Constitutional symptoms	25	78.1%
Arthritis/ arthralgia	18	56.3%
Photosensitivity	8	25%
Malar rash	24	75%
Alopecia	14	43.8%
Oral ulcers	6	18.8%
Raynaud's phenomenon	5	15.6%
Serositis	6	18.8%
Renal affection	12	37.5%
Neuropsychiatric affection	4	12.5%
Thrombotic events	3	9.4%

All of our patients were positive for ANA, and 29 patients were positive for anti-DNA antibodies at the time of the study. One patient was positive for anti-RO antibodies. The mean ESR of the patients was  $72.6 \pm 38.8$  mm/hr and ranged from 25 to 160 mm/hr. The complete blood picture of our patients revealed thrombocytopenia in 7 patients (21.9%),

lymphopenia in 5 patients (15.6%) and anemia in 21 patients (65.6%) with mean Hemoglobin of  $10.04 \pm 2.1$  gm/dl and ranging from 5.7 to 14.2 gm/dl. Liver function tests were normal in all patients while creatinine was high in 7 patients (21.9%).

Disease Activity by the SLEDAI of our patients revealed a range from 0-28 with a mean of  $9.7 \pm 7.2$ . The organ damage as assessed by the SLICC score and revealed a mean of  $1.38 \pm 1.43$  and a range of 0-4.

**Expression of CXCR4 on lymphocytes**

The mean percent of patients' lymphocytes expressing CXCR4 was  $53.6 \pm 17.4\%$  with a range of 5-82%, while their T lymphocytes showed positivity for CXCR4 in  $43.4\% \pm 8.97\%$  with a range of 24.3 - 57%. As for the control group the mean percent of lymphocytes expressing CXCR4 was  $40.1 \pm 9.7\%$  with a range of 29-56%, while the T lymphocytes showed a mean percent of expression of  $26.3 \pm 6.8\%$  and a range of 16.9% to 34.6%. There was a significant increase in CXCR4 expression on Lymphocytes in general and T- lymphocytes among SLE patients compared to healthy controls as shown in table (2).

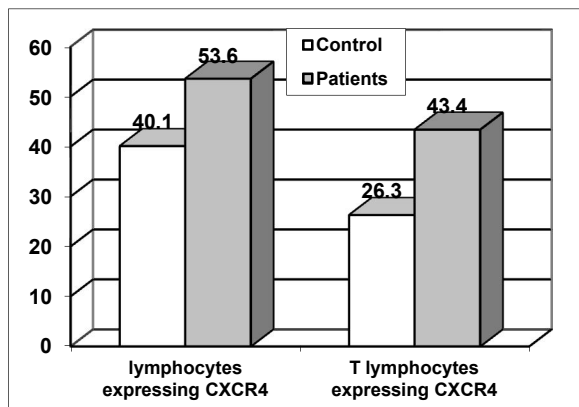


Fig. (2): Mean percentage of Total lymphocytes and T lymphocytes expressing CXCR4 among the control group and patients.

Table (2): Comparison between the percentage of Total lymphocytes and T lymphocytes expressing CXCR4 among the control group and patients using student t test.

	Group	Mean	SD	t	P value	Sig.
Percentage of lymphocytes expressing CXCR4	Control	40.08	9.67	3.1	<0.01	HS
	Patients	53.58	17.43			
Percentage of T-lymphocytes expressing CXCR4	Control	26.3	6.79	6.4	<0.001	HS
	Patients	43.37	8.97			

**The relation between CXCR4 expression and different clinical and lab parameters:**

SLE patients with joint manifestations had significantly lower frequency of expression of

CXCR4 on their T cells than patients without joint manifestations (40.1% and 47.6% respectively,  $t=2.69$ ,  $p<0.05$ ). On the other hand, patients with serositis had significantly higher levels of expression of CXCR4 on their lymphocytes (58.7%) when compared to patients free from serositis (38.2%) ( $t= -2.5$ ,  $p<0.05$ ). Patients with nephritis did not show a significant difference in their chemokine receptor expression as compared to patients without nephritis. Also, no such difference was found regarding the any other clinical or lab characteristic of the patients.

Correlation between percentage of T-lymphocytes expressing CXCR4 receptors and different clinical and laboratory data of the patients revealed a positive significant correlation between T lymphocytes expressing CXCR4 and disease activity measured by the SLEDAI as well as with the ESR ( $r= 0.38$ ,  $p<0.05$  and  $r= 0.41$ ,  $p<0.05$ ). There was also a significant negative correlation between the percent of lymphocytes expressing CXCR4 and the organ damage measured by the SLICC score ( $r=-0.36$ ,  $p<0.05$ ). Correlation studies between CXCR4 expression and all the other clinical or lab characteristic of the patients did not reach statistical significance.

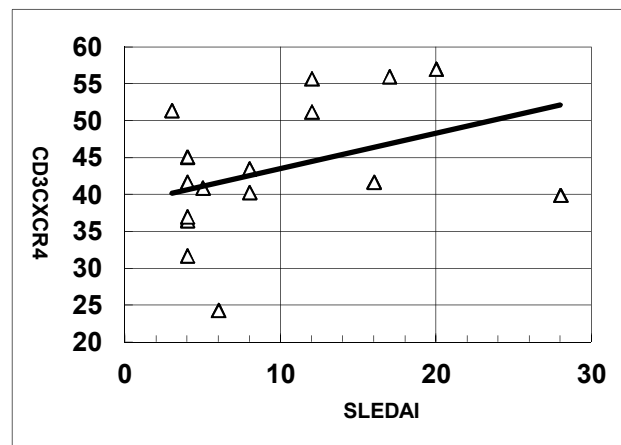
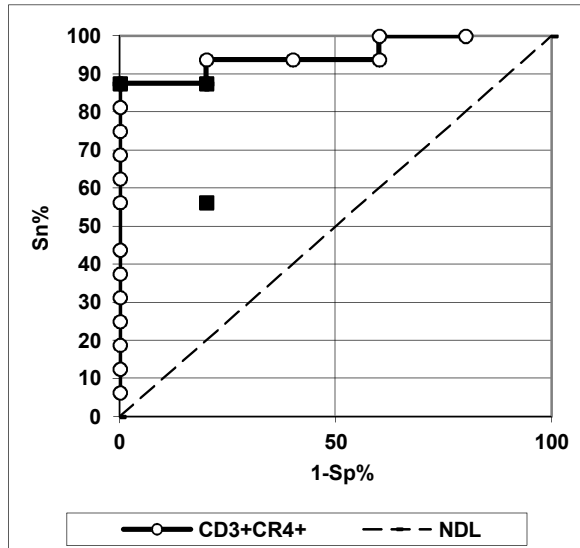


Fig. (3): Regression analysis showing the correlation between CXCR4 expression on T lymphocytes and SLEDAI among SLE patients

**ROC curve analysis:**

The test validity characters of CXCR4 expression on T lymphocytes for discrimination of SLE at the best cutoff value of 34.6% showed 100% specificity, 87.5% sensitivity and 90.5% efficacy.



**Fig. ( 4 ):** ROC curve analysis showing the diagnostic performance of percentage of T lymphocytes expressing CXCR4 in discriminating patients with SLE from healthy controls

#### 4. Discussion:

In systemic lupus erythematosus (SLE), the combination between specific environmental factors and a predisposing genetic background contributes to the development of impaired immune tolerance the uncontrolled production of autoantibodies. This multistep process involves many immune cell populations. Among the cells that participate in the initiation, progression and perpetration of the disease, T lymphocytes play a key role in all stages. T-cell abnormalities and aberrant T helper cytokine profiles have been implicated in the loss of immune tolerance to nuclear and cytoplasmic antigens and linked to a variety of clinical manifestations in SLE (La Cava, 2009).

The interaction of CXCL12 and CXCR4 results in migration, integrin activation, and chemotaxis of lymphocytes, monocytes, and neutrophils and hematopoietic progenitor cells. These processes assist in the recruitment of these cells to affected peripheral tissues in lupus, such as the kidney and skin. In addition, this binding enhances survival, proliferation, and transcription in the CXCR4-expressing cells (Nanki and Lipsky, 2000, & Wong and Korz, 2008).

Involvement of CXCR4 in the pathogenesis of SLE was suggested by several findings in murine models of lupus. One of these findings was the significant up-regulation of CXCR4 on monocytes, neutrophils, B cell subsets, and plasma cells in multiple murine models of lupus. Tissue samples from the kidneys of these mice showed CXCL 12

upregulation in the glomeruli and tubules. Furthermore upon administration of a CXCR4 peptide antagonist the mice kidney disease improved (Wang *et al.*, 2009). Several researches confirmed a role of the CXCR4/CXCL12 axis in human SLE. Among these is the finding of strong CXCR4 staining in perivascular inflammatory cells upon immunohistochemical staining of cutaneous lupus skin biopsies and increased CXCL12 reactivity in dendritic and endothelial cells in the skin (Meller *et al.*, 2005). Another report has documented that SLE patients exhibited significantly higher CXCL12 serum levels compared with healthy controls (Robak *et al.*, 2007).

In agreement with the hypothesis that CXCR4 has an important role in SLE, our study revealed a significant increase in CXCR4 expression on Lymphocytes in general and T- lymphocytes among SLE patients compared to healthy controls. These findings support the findings of Wang *et al* who documented increased expression of CXCR4 on CD4 T cells (Wang *et al.*, 2010)

Amoura and colleagues have reported that SLE patients did not differ significantly in CXCR4 expression on CD4+ and CD8+ T cells compared with controls (Amoura *et al.*, 2003). Discrepancies in the findings of this study and the current one may be due to varying characteristics of the SLE patients studied especially that the report did not delineate clinical characteristics of the SLE patients investigated.

Another group found that three subclasses of memory CD4+ T cells, CCR7+/CD27+, CCR7-/CD27+, and CCR7-/CD27-, isolated from eight SLE patients showed lower percentages expressing CXCR4 compared with controls (Fritsch *et al.*, 2006). This discrepancy in findings may be due to the fact that this study only assessed memory CD4+ T cells which are only a subclass of T cells and though expression on them may be lower than controls yet the total T cell expression may yet be high. Also this finding was reported from a sample of 8 SLE patients which is too small a number to draw conclusions from.

We found a positive significant correlation between T lymphocytes expressing CXCR4 and disease activity measured by the SLEDAI. This is in accordance with the results of Wang *et al.*, 2010 whose results showed 1.18-fold increase in CXCR4 on CD4 T cells in the group of patients with higher SLEDAI scores though the values did not reach statistical significance. These results imply a possible role of CXCR4 in driving active disease in SLE.

Our results demonstrate that patients with nephritis did not show a significant difference in CXCR4 expression as compared to patients without

nephritis. SLE patients with joint manifestations had significantly lower frequency of expression of CXCR4 on their T cells than patients without joint manifestations. Such a difference was not found regarding the any other clinical or lab characteristic of the patients. Also, we report a significant negative correlation between the percent of circulating lymphocytes expressing CXCR4 and the organ damage measured by the SLICC score. These findings are similar to the results of Wang *et al.*, 2010 who reported that correlations between CXCR4 surface expression and various laboratory parameters, including anti-double-stranded DNA titer, 24-hour proteinuria, serum creatinine, C3, or C4, were not found to be significant. This could be explained by the possibility that CXCR4 positive cells are attracted to the damaged organs and the homing of these cells to peripheral tissue, since they are more likely than naive cells to position themselves in these areas. This is reinforced by results of research that demonstrated enhanced levels of CXCL12 in tubules and glomeruli of kidneys (Wang *et al.*, 2010). Balabanian *et al.* also found higher CXCL12 expression in the kidneys in murine studies and reported prevention of nephritis and antibody production by mAbs against CXCL12 (the ligand for CXCR4) (Balabanian *et al.*, 2003). This peripheralization may result in the varying levels of circulating CXCR4 expressing lymphocytes in relation to the different organs affected especially given the multiple organ affection found in SLE resulting in the wide dispersion of these cells.

The test validity characters of CXCR4 expression on T lymphocytes for discrimination of SLE at the best cutoff value of 34.6% showed 100% specificity, 87.5% sensitivity and 90.5% efficacy which further reinforces its importance in the pathogenesis of SLE and directs our attention to it as a possible marker of SLE and an indicator of disease activity.

#### Conclusion:

CXCR4 expression levels are elevated on total lymphocytes as well as T cells from SLE patients. This increase in cell expression of CXCR4 correlates positively with disease activity. These findings suggest that CXCR4 hyperexpression may play a vital role in the pathogenesis of SLE, and may after further studies be used as an indicator of disease activity. This also suggests CXCR4 antagonists may halt the role that these cells in the pathogenesis of the disease and improve prognosis for SLE patients.

#### References:

- Amoura Z, Combadiere C, Faure S, *et al.* (2003): Roles of CCR2 and CXCR3 in the T cell-mediated response occurring during lupus flares. *Arthritis Rheum*;48:3487-96
- Balabanian K, Couderc J, Bouchet-Delbos L, *et al.* (2003): Role of the chemokine stromal cell-derived factor 1 in autoantibody production and nephritis in murine lupus. *J Immunol*;170:3392-400
- Bombardier C, Gladman DD, Urowitz MB, Caron D, Chang CH (1992): Derivation of the SLEDAI. A disease activity index for lupus patients. The Committee on Prognosis Studies in SLE. *Arthritis Rheum. Jun*;35(6):630-40.
- Busillo JM and Benovic JL (2007): Regulation of CXCR4 signalling. *Biochim Biophys Acta. April*; 1768(4):952-63.
- Choi W T and An J (2011): Biology and clinical relevance of chemokines and chemokine receptors CXCR4 and CCR5 in human diseases. *Exp Biol Med (Maywood). Jun 1*;236(6):637-47.
- Chong B F and Mohan C (2009): Targeting the CXCR4/CXCL12 axis in systemic lupus erythematosus. *Expert Opin. Ther. Targets* 13(10):1147-1153.
- De Klerck B, Geboes L, Hatse S, *et al.* (2005): Pro-inflammatory properties of stromal cell-derived factor-1 (CXCL12) in collagen-induced arthritis. *Arthritis Res Ther*;7:R1208-20
- Fritsch RD, Shen X, Illei GG, Yarboro CH, Prussin C, Hathcock KS, Hodes RJ, Lipsky PE. (2006): Abnormal differentiation of memory T cells in systemic lupus erythematosus. *Arthritis Rheum. Jul*;54(7):2184-97.
- Gladman D, Ginzler E, Goldsmith C, Fortin P, Liang M, Urowitz M, Bacon P, Bombardieri S, Hanly J, Hay E, Isenberg D, Jones J, Kalunian K, Maddison P, Nived O, Petri M, Richter M, Sanchez-Guerrero J, Snaith M, Sturfelt G, Symmons D, Zoma A (1996): The development and initial validation of the Systemic Lupus International Collaborating Clinics/American College of Rheumatology damage index for systemic lupus erythematosus. *Arthritis Rheum. Mar*;39(3): 363-9. Review
- Hochberg MC (1997): Updating the American College of Rheumatology revised criteria for the classification of systemic lupus erythematosus [letter]. *Arthritis Rheum*;40:1725.
- Kohler RE, Comerford I, Townley S, *et al.* (2008): Antagonism of the chemokine receptors CXCR3 and CXCR4 reduces the pathology of experimental autoimmune encephalomyelitis. *Brain Pathol*;18:504-16



- La Cava A. (2009): Lupus and T cells. *Lupus*. Mar;18(3):196-201.
- Leng L, Chen L, Fan J, Greven D *et al.* (2011): A Small Molecule MIF Antagonist Protects against Glomerulonephritis in Lupus-prone NZB/NZW F1 and MRL/lpr Mice *J Immunol*. January 1; 186(1): 527–538
- Meller S, Winterberg F, Gilliet M, *et al.* (2005): Ultraviolet radiation-induced injury, chemokines, and leukocyte recruitment: an amplification cycle triggering cutaneous lupus erythematosus. *Arthritis Rheum*;52:1504-16
- Nanki T, Lipsky PE. (2000) Cutting edge: stromal cell-derived factor-1 is a costimulator for CD4 T cell activation. *J Immunol*;164:5010–4.
- Peled A, Wald O, Burger J (2012): Development of novel CXCR4-based therapeutics. *Expert Opin Investig Drugs*. Mar;21(3):341-53.
- Rahman A, Isenberg DA. (2008): Mechanisms of disease: Systemic lupus erythematosus. *New England Journal of Medicine*.; 358:929–939.
- Robak E, Kulczycka L, Sysa-Jedrzejowska A, *et al.* (2007). Circulating proangiogenic molecules PIGF, SDF-1 and sVCAM-1 in patients with systemic lupus erythematosus. *Eur Cytokine Netw*;18:181-7
- Sun X, Cheng G, Hao M, Zheng J, Zhou X, Zhang J, Taichman R, Pienta K, and Wang J (2010): CXCL12/CXCR4/CXCR7 Chemokine Axis and Cancer Progression. *Cancer Metastasis Rev*. December ; 29(4): 709–722.
- Wang A, Fairhurst AM, Tus K, Subramanian S, Liu Y, Lin F, Igarashi P, Zhou XJ, Batteux F, Wong D, Wakeland EK, Mohan C. (2009): CXCR4/CXCL12 hyperexpression plays a pivotal role in the pathogenesis of lupus. *J Immunol*. Apr 1;182(7):4448-58.
- Wang A, Guilpain P, Chong BF, Chouzenoux S, Guillevin L, Du Y, Zhou XJ, Lin F, Fairhurst AM, Boudreaux C, Roux C, Wakeland EK, Davis LS, Batteux F, Mohan C (2010): Dysregulated expression of CXCR4/CXCL12 in subsets of patients with systemic lupus erythematosus. *Arthritis Rheum*. Nov;62(11):3436-46.
- Wong D, Korz W (2008): Translating an antagonist of chemokine receptor CXCR4: from bench to bedside. *Clin Cancer Res*;14:7975–80.
- Yu SL, Kuan WP, Wong CK, Li EK, Tam LS (2012): Immunopathological roles of cytokines, chemokines, signaling molecules, and pattern-recognition receptors in systemic lupus erythematosus. *Clin Dev Immunol*., 2012:715190

10/10/2012

# Life Science Journal

(Acta Zhengzhou University Overseas Edition)

## Call for Papers

The academic journal “*Life Science Journal*” (ISSN: 1097-8135) is inviting you to publish your papers.

*Life Science Journal*, the Acta Zhengzhou University Oversea Version registered in the United States, is an international journal with the purpose to enhance our natural and scientific knowledge dissemination in the world under the free publication principle. The journal is calling for papers from all who are associated with Zhengzhou University-home and abroad. Any valuable papers or reports that are related to life science-in their broadest sense-are welcome. Other academic articles that are less relevant but are of high quality will also be considered and published. Papers submitted could be reviews, objective descriptions, research reports, opinions/debates, news, letters, and other types of writings. Let's work together to disseminate our research results and our opinions.

Please send your manuscript to [editor@sciencepub.net](mailto:editor@sciencepub.net).

**Address:**

Life Science Journal - Acta Zhengzhou University Overseas Edition

Marsland Press

PO Box 180432, Richmond Hill, New York 11418, USA

Telephone: (347) 321-7172

**Emails:** [editor@sciencepub.net](mailto:editor@sciencepub.net); [sciencepub@gmail.com](mailto:sciencepub@gmail.com); [lifesciencej@gmail.com](mailto:lifesciencej@gmail.com);

**Website:** <http://www.sciencepub.net>; <http://www.lifesciencesite.com>

Volume 9, Number 4, (Cumulative No.31) Part 20 December 25, 2012 ISSN:1097-8135

# Life Science Journal

Marsland Press

PO Box 180432, Richmond Hill, New York 11418, USA

Website:  
<http://www.sciencepub.net>

Emails:  
[editor@sciencepub.net](mailto:editor@sciencepub.net)  
[sciencepub@gmail.com](mailto:sciencepub@gmail.com)

Phone: (347) 321-7172

Copyright © 2005-2012 Marsland Press / Zhengzhou University

