

Life Science Journal

Life Science Journal

Marsland Press

PO Box 180432, Richmond Hill, New York 11418, USA

Website:
<http://www.sciencepub.net>

Emails:
editor@sciencepub.net
sciencepub@gmail.com

Phone: (347) 321-7172

Life Science Journal 2012 Volume 9, Number 4, Part 9 ISSN:1097-8135



Volume 9, Number 4, Part 9 December 25, 2012 ISSN:1097-8135

Life Science Journal



 **MARSLAND PRESS**
Multidisciplinary Academic Journal Publisher

Websites:
<http://www.lifesciencesite.com>
<http://www.sciencepub.net>

Emails:
lifesciencej@gmail.com
editor@sciencepub.net

Life Science Journal

Acta Zhengzhou University Oversea Version
(Life Sci J)

Life Science Journal, the Acta Zhengzhou University Oversea Version, is an international journal with the purpose to enhance our natural and scientific knowledge dissemination in the world under the free publication principle. The journal is calling for papers from all who are associated with Zhengzhou University-home and abroad. Any valuable papers or reports that are related to life science - in their broadest sense - are welcome. Other academic articles that are less relevant but are of high quality will also be considered and published. Papers submitted could be reviews, objective descriptions, research reports, opinions/debates, news, letters, and other types of writings. Let's work together to disseminate our research results and our opinions.

Editor-in-Chief: Shen, Changyu, Ph.D., Professor, Chinese Academy of Sciences

Associate Editors-in-Chief: Ma, Hongbao; Cherng, Shen; Xin, Shijun

Editorial Boards: Aghdam, Hashemi; An, Xiuli; Chandra, Avinash; Chen, George; Dong, Ziming; Duan, Guangcai; Edmondson, Jingjing; Gao, Danying; Huang, Shuan-Yu; Li, Xinhua; Li, Yuhua; Lindley, Mark; Liu, Hua; Liu, Hongmin; Ma, Margret; Qi, Yuanming; Sabyasachi Chatterjee; Shang, Fude; Shi, Lifeng; Song, Chunpeng; Sun, Yingpu; Wang, Lidong; Wen, Jianguo; Xu, Cunshuan; Xu, Yuming; Xue, Changgui; Zaki, Mona; Zhang, Jianying; Zhang, Kehao; Zhang, Shengjun; Zhang, Xueguo; Zhang, Zhan; Zhang, Zhao; Zhu, Huaijie

Introductions to Authors

1. General Information

- (1) **Goals:** As an international journal published both in print and on internet, **Life Science Journal** is dedicated to the dissemination of fundamental knowledge in all areas of nature and science. The main purpose of **Life Science Journal** is to enhance our knowledge spreading in the world under the free publication principle. It publishes full-length papers (original contributions), reviews, rapid communications, and any debates and opinions in all the fields of nature and science.
- (2) **What to Do:** The **Life Science Journal** provides a place for discussion of scientific news, research, theory, philosophy, profession and technology - that will drive scientific progress. Research reports and regular manuscripts that contain new and significant information of general interest are welcome.
- (3) **Who:** All people are welcome to submit manuscripts in life science fields. Papers of other fields are also considered.
- (4) **Copyright and Responsibility of Authors to their Articles:** When the manuscript(s) is submitted to the journal, the authors agree the following: All the authors have participated sufficiently in this work; The article is not published elsewhere; Authors are responsibility on the contents of the article; The journal and author(s) have same right for the copyright of the article and either of the journal or author(s) can use it by anyway without noting the other party.
- (5) **Publication Costs:** US\$500 per article to defray costs of the publication will be paid by the authors when it is received. Extra expense for color reproduction of figures will be paid by authors (estimate of cost will be provided by the publisher for the author's approval).
- (6) **Advertisements:** The price will be calculated as US\$400/page, i.e. US\$200/a half page, US\$100/a quarter page, etc. Any size of the advertisement is welcome.

2. Manuscript Preparation

Each manuscript is suggested to include the following components but authors can do their own ways:

- (1) **Title:** including the complete article title; each author's full name; institution(s) with which each author is affiliated,

with city, state/province, zip code, and country; and the name, complete mailing address, telephone number, facsimile number (if available), and at least one email address for author(s). (2) **Abstract:** including Background, Materials and Methods, Results, and Discussions. (3) **Key Words.** (4) **Introduction.** (5) **Materials and Methods.** (6) **Results.** (7) **Discussions.** (8) **Acknowledgments.** (9) **References.**

3. Manuscripts Submission

- (1) **Submission Methods:** Submission through email (editor@sciencepub.net) is encouraged.
- (2) **Software:** The Microsoft Word file will be preferred.
- (3) **Font:** Normal, Times New Roman, 10 pt, single space.
- (4) **Indent:** Type 2 space in the beginning of each new paragraph.
- (5) **Manuscript:** Don't use "Footnote" or "Header and Footer".
- (6) **Email:** At least one author's email must be put under title.
- (7) **Title:** Use Title Case in the title and subtitles, e.g. "**Debt and Agency Costs**".
- (8) **Figures and Tables:** Use full word of figure and table, e.g. "**Figure 1. Annual Income of Different Groups**", **Table 1. Annual Increase of Investment**".
- (9) **References:** Cite references by "last name, year", e.g. "(Smith, 2003)". References should include all the authors' last names and initials, title, journal, year, volume, issue, and pages etc.

Reference Examples:

Journal Article: Hacker J, Hentschel U, Dobrindt U. Prokaryotic chromosomes and disease. *Science* 2003;301(34):790-3. **Book:** Berkowitz BA, Katzung BG. Basic and clinical evaluation of new drugs. In: Katzung BG, ed. Basic and clinical pharmacology. Appleton & Lance Publisher. Norwalk, Connecticut, USA. 1995:60-9.

- (10) **Submission Address:** editor@sciencepub.net, Marsland Press, PO Box 180432, Richmond Hill, New York 11418, USA, 347-321-7172.

Marsland Press / Zhengzhou University
PO Box 180432, Richmond Hill, New York 11418, USA
<http://www.lifesciencesite.com>; <http://www.sciencepub.net>
lifesciencej@gmail.com; editor@sciencepub.net
© 2005-2012 Marsland Press / Zhengzhou University

CONTENTS

183	Ascertainment of individual specifications of addicts admitted to Tehran Treatment Centers Moraveji M, MS.c, Sahebalzamani, Ph.D, Bazargan M, MD	1225-1231
184	Assessment of suitable Location for Construction of groundwater dams Leila Sharifi , Mohamad Karami	1233-1236
185	Treatment of the Subretinal Hemorrhage by the Use of Deep Periocular Injection of Bevacizumab ----A Safer Method Chih-Yaun Yang, Kuang-Jen Chien, Tsung-Hsung Chang, Ren-Jy Ben, Jen-Hsiel Lin, Chi-Ting Horng	1237-1241
186	Efficacy of intraumbilical vein (IUV) injection of oxytocin in active management of the third stage of labor Farideh Movahed, Reyhaneh Ramazan Nejhah, Ezzatalsadat Haji Seid Javadi, Amir Javadi, Fatemeh Lalooha, Omid Mashrabi	1242-1246
187	The relationship between the level of homocysteine in mother's serum and the intensity of preeclampsia Ezzatalsadat Haji Seid Javadi, Fatemeh Ghorbali, Mohammadreza Sarookhani, Amir Javadi, Omid Mashrabi	1247-1249
188	Study on serum Copper and Zinc level of children with epilepsy during long term therapy with anticonvulsants Lida Saboktakin, Mohammad Barzegar, Amir Ghorbani Hagh Jo, Mohammad Emamalizadeh	1250-1254
189	Compression cefazolin at cord clamping & before in section skin incision in decreasing the infectious complication in patients underwent cesarean section Ezzatalsadat Haji Seid Javadi, Mehrnoosh Eshfahani, Omid Mashrabi	1255-1257
190	Comparison of hematocrit concentration after cesarean section between two methods: general anesthesia Vs spinal anesthesia Ezzatalsadat Haji Seid Javadi, Shamsi Niazi, Aamir Javadi, Omid Mashrabi	1258-1260
191	A Survey Of Lean Implementation Gap Analysis In Public Sector Organizations Irfan Ghalib , Mujtaba Hassan Agha, Shafqat Hameed, Muhammad Abbas Choudhary	1261-1269
192	The Role Of Data Protection Technologies: A Case Study Shafqat Hameed, Mujtaba Hassan Agha, Muhammad Abbas Choudhary	1270-1279
193	Prevalence of Vaginal Candidiasis infection in women referred to Kermanshah hygienic centers, Iran in 2010 Reza Faraji , Mehr Ali Rahimi , Mojdeh Assarehzadegan	1280-1283
194	The pattern of transmission in the market price of chicken meat in Iran Seyed Nematollah Mousavi and Neda Sedghi	1284-1291
195	Substance Use Among Non-fatally Injured Patients Attended Emergency Departments in North-East of Iran; Sabzevar Zardosht Roqhaye, Hashemian Masoumeh, Moghaddamhosseini Vahideh, Akaberi Arash	1292-1297

- 196 **Educational creativity of teachers can be changed using a suitable management and leadership style of managers (standard-oriented and relation oriented)** 1298-1303
Homa Ghafourian
- 197 **Aging populations' quality of life: An emerging priority for public health system in Iran** 1304-1309
Jabbar Heydari, Samad Rouhani, Reza Ali Mohammadpour
- 198 **Seasonal variation in the incidence of preeclampsia based on the time of conception** 1310-1314
Fariba Nanbakhsh , Farzane Broomand ,HamideMohaddesi , S Nefoozi , Pouya Mazloomi
- 199 **Comparison of Helicobacter pylori infection between pregnant women with hyperemesis gravidarum and controls** 1315-1318
Fariba Nanbakhsh, Hamideh Mohaddesi,FatemehBahadory, Javad Amirfakhrian, Pouya Mazloomi
- 200 **Studying the social and cultural factors related to Tabriz citizen's participation** 1319-1323
Mahmoud Elmi
- 201 **Bioremediation of Khormah Slaughter House Wastes by Production of Thermoalkalitable Lipase for Application in Leather Industries.** 1324-1335
Bayoumi, R.A., Atta, H.M.and El-Sehrawy, M.H.
- 202 **Intellectual capital management, a paradigm to enhance the human resource management in knowledge-based economy** 1336-1340
Ali Atashi , Hossein Kharabi
- 203 **Effect of high-performance human resource management in the corporate entrepreneurship.** 1341-1353
Ali Atashi, Hossein kharabi
- 204 **Hiccups due to hepatitis on the base of Iranian Traditional medicine** 1354-1356
M minae,Q Mohammadi, M somi, M Mosadegh M Kamalinejad, A Nikbakht Nasirabadi
- 205 **A local leadership model for adaptive studying leadership style of government and non-government newspapers** 1357-1364
Farhangi Ali Akbar, Mirsepasi Naser, Memarzadeh Tehrani Gholamreza, Samadi Mehran
- 206 **The comparison of injuries in boys' amateur epical athletes in three fields: Kyokushin ka, controlling Karate and Aikido** 1365-1371
Dr. Ghofrani Mohsen, Mousavi Seyyed Hamed
- 207 **Comparison ofthe Initial State of Active and Passive on the Relative Peak Anaerobic Power and Blood Lactate Elite Handball Players** 1372-1374
Gholamhasan jafarzadeh, Mohammad Nasiri
- 208 **The Role of IMS Functional Architecture in Next Generation Network** 1375-1382
Sheyda Kiani Mehr

Ascertainment of individual specifications of addicts admitted to Tehran Treatment CentersMoraveji M, MS.c¹, Sahebalzamani, Ph.D², Bazargan M, MD³¹ Dept of Nursing, Zanjan Branch, Islamic Azad University, Zanjan, Iran.² Dept of Nursing, Tehran Branch, Islamic Azad University, Tehran, Iran.³ Tehran Uni. of medical sciences, Tehran, Iran.

Abstract: Purpose: This is an analytical-descriptive study aimed at analyzing individual specifications of addicts who have gone to treatment centers of Tehran in the year 2006. **Materials and Methods:** Investigation members were all addicts admitted to treatment centers of Tehran, investigation method was random sampling, investigation place was rehabilitating drug addicts and NGOs, the number of all members was 256 and input assembling instrument was questionnaires comprising Demography and MMPI questionnaire. The results are derived from descriptive and deductive statistics and are analyzed by SPSS software. **Results:** The results demonstrate the fact that 19.1% of addicts are jobless, 38% are lessees, 2.3% are illiterate, 60.5% are single and 57.8% of them have an income of less than 2,000,000 Rials, reflecting the fact that unemployment has no relation with the tendency to addiction - Even those with high economic and educational position have a great tendency to addiction mirroring the failure of society's supporting. Based upon MMPI, the amount of exposition to danger in addicts consists of 7.81% in mania, 28.12 % SC, 12.5% in paranoia, and 33.98% in unsociability, 12.5% mysterious, 57.42% in depression and 22.26 in self-assumption of illness, reflecting disorder in their personality. **Conclusion:** So, according to MPI, if the results of D, PD and SC in addicts are high and the L and K rates are low, treatment and consulting service is advised.

[Moraveji M., Sahebalzamani, Bazargan M. **Ascertainment of individual specifications of addicts admitted to Tehran Treatment Centers.** *Life Sci J* 2012;9(4):1225-1231] (ISSN:1097-8135). <http://www.lifesciencesite.com>. 183

Keywords: addiction, characteristics, MMPI questionnaire

Introduction:**Identifying personality of the addicts receiving services in treatment centers of Tehran**

When talking about children's disorders and problems, drug abuse (including natural and man-made drugs) should be taken into special account, due to direct relation between addiction and health problems and developmental disorders in children, even in embryos.

According to historical and anthropological researches, in ancient times, taking drugs was limited to only adults and there have never been any tendency among the young towards drugs. Drugs were taken by certain groups and on special occasions. The most important thing about this way of taking drugs was that they never resulted in addiction.

Later on, when morphine, heroin, and cocaine came in some cases of addiction were seen among the young. However, by the midst of 1960s, the number of addicted were too small to attract the social attention in wide range.

It was only in late 1960s that taking drugs was suddenly prevalent among the young and teenagers, and became a worldwide multi-aspect problem, spreading out from one continent to another. (Gysp D. Gnavr, 1987)

Now, tens of years after prevalence of

drug abuse, the question "does addiction have any age limit?" seems a warning one; the answers given angrily by parents, teachers and authorities are threatening.

According to statistical reports, the starting age of addiction is estimated between 16 and 20, although young adults are more at risk. The average age of addiction in prisons is 29 and 27 in self-introducing centers for rehabilitating drug addicts. Domestic researches have shown that most of country's addicts are between the ages 15 and 27. (Zakariyae, pp 12-13, 2003)

According to 1381 census figures, taken by the Drug-fighting Center of NAJA, nearly 5% of addicts are under 15, about 31% are between 15 and 30, 31 to 45% arrested or admitted addicts are 15 - 30 years old. Such a growing trend towards addiction indicates that common methods of addict prevention, drug rehabilitation, or drug-fighting measures have not been effective. (Zakariyae, pp 12-13, 2003).

Considering the above facts, the purpose of this research is to study characteristics of the addicts, who go to addict rehabilitation centers in Tehran, based on short 71-question form of Minnesota Multiphase Personality Inventory (MMPI).

In other words, the main question is this: "Is there any morphological model of addicts or not?" if any, how can it be expressed by demographic

factors? To find out, the following questions were brought up and investigated:

- 1- Are personal, social, and familial characteristics of the admitted addicts different?
- 2- How much anti-social are they?
- 3- How much paranoid are they?
- 4- How much depressive are they?
- 5- How much maniac are they?
- 6- How much hypochondriac are they?
- 7- How much hysterical are they?
- 8- How much neurasthenic are they?
- 9- How much do they suffer from schizophrenia?
- 10- Are their scores on L scale of MMPI test different?
- 11- Are their scores on F scale of MMPI test different?
- 12- Are their scores on K scale of MMPI test different?

Method:

This research is of post-event kind. The statistical community of the research includes the addicted men who go to self-introducing centers to be helped abandon the habit and return to their families and society. The Available 256 addicted men were selected.

Tools of research:

Minnesota Multiphase Personality Inventory (MMPI) Demographic questionnaire containing questions on personal, familial, social and economic background of addicts Hathaway, LR, and McKinley, JE designed MMPI test in Minnesota University in 1943. The main form contains 556 questions and has been administered to both individuals and groups of people over 16 years old. This test measures present time and is formed of 9 questions and several/a few short forms. Its short 71-question form was used in this research to test personality traits of sample individuals. (Trole, p.207, 2002)

The scales of Minnesota's primary questionnaire tested the following characteristics:

- 1) Anti-social; 2) Paranoia; 3) Depression; 4) mania
- 5) Hypochondria; 6) Neurasthenia; 7) Hysteria; 8) Schizophrenia; 9) L scale; 10) F scale 11) K scale.

Mac kin Canon designed the 71-question short form in 1948. In 1353 H.Sh. Okhovvat, Barahani, Shamlu, and Now'parast translated it into Persian. The form was used for a group of 30 addicts in Vanak Hospital in 1353 H.Sh and its reliability was confirmed for Iranian sample population. The 71-question short form includes three scales of reliability: L, F and K.

Data analysis:

In order to analyze the data, descriptive and inferential methods were used. In descriptive statistic, according to sorts and specifications of the data, absolute and relative frequency distribution tables

and one-dimensional and two-dimensional percentage tables were used. Inferential statistics included X^2 and Fisher test; and measurements were analyzed using SPSS software.

Results:

Question 1:

The analysis of the addicts' demographical data showed that from 256 cases:

- 1) 49 cases were unemployed, 18 cases were workers, 10 cases were employed, 169 cases were self-employed, and 10 cases were college students.
- 2) 98 cases lived in rented houses and 157 cases had their own houses.
- 3) 6 cases were illiterate, 38 cases had finished elementary, 81 cases were juniors, 101 cases had finished high school, and 30 cases had higher education.
- 4) 155 cases were single, 82 cases were married, four cases were divorced, and 15 cases were separated.
- 5) 148 cases earned less than 200,000 tomans a month, 57 cases earned between 200,000 and 400,000, 25 cases earned between 400,000 and 600,000, and 26 cases earned over 600,000.
- 6) 89 cases were addicted to opium, 53 cases were addicted to heroin, 69 cases were addicted to crack, and 49 cases were addicted to other drugs.
- 7) 141 cases used inhalation method, 38 cases injected drugs, 54 cases ate drugs, and 23 cases used a combination of different methods, e.g. both injection and inhalation.

The following table shows the sample group is other demographical data (Table 1-1):

Table 1-1: frequency distribution and percentage of the reasons of starting addiction

Proportion (percentage)	number	statistical factors reasons
20.15	26	egotistical
50.39	129	companionship and peer groups' pressure
5.46	14	following adults
30	59	curiosity
35.55	91	disturbed familial situation
3.12	8	education failure
17.96	46	pleasure seeking
10.15	26	drug availability
34.37	88	emotional problems
5.85	15	relief of physical pains
12.10	31	unemployment
12.5	32	love failure
2.73	7	income surplus
10.93	28	lack of entertainments
4.68	12	to increase bravery

According to the above report on the cases, peer groups' pressure had inclined more than 50% of the cases to drug, and surplus of income was the reason in 2.73% of them (7 cases), respectively the

most and the least important reasons of tendency towards taking drugs.

Table 1-2: occupations of the parents of the sample addicts

total		homemaker		unemployed		employed		worker		self-employed		occupation
p.c	no	p.c	no	p.c.	no	p.c	no	p.c	no	p.c	no	parents
100%	217	0	0	9	20	26	56	14	31	52	110	father
100%	244	91	222	0	0	6	14	3	8	0	0	mother

The table shows that among all 256 cases, 217 cases mentioned their fathers' job and 244 mentioned their mothers'. Most of fathers are self-employed and most of mothers are homemakers. Among fathers, unemployment rate is the lowest.

Table 1-3: health problem record of cases

percent	number	statistical index illness
4.29	11	heart disease
3.51	9	digestive problems
0.78	2	blood sugar
1.95	5	pulmonary disease
3.51	9	renal failure
2.73	7	blood pressure
38.67	99	mental disorder
44.56	114	healthy
100	256	total

The above table shows high correlation between physical/ mental illnesses and drug abuse.

Table 1-4: frequency distribution and proportion of the cases' previous conviction record and addiction record among their family members

distant relations' addiction	close relations' addiction	cases' conviction	previous conviction statistical index number
157	137	83	number
61.32	53.15	32.42	proportion (percent)

The above table indicates other dangerous factors leading to addiction, among which relatives' addiction (61.32%) is the most dangerous. Furthermore, analyzing demographical data of the sample group and combining it with the results of subscales of MMPI Test made it obvious that:

- 1) Lying scale is connected with accommodation and education.
- 2) Correction scale is connected with accommodation, education, and marital status.
- 3) Unfavorable scale is connected with occupation, accommodation, education, and marital status.
- 4) Hypochondria scale is connected with occupation, accommodation, education, marital status, income, and consumption

method.

- 5) Depression scale is connected with occupation, accommodation, education, marital status, and consumption method.
- 6) Hysteria scale is connected with accommodation and the kind of taken drugs.
- 7) Antisocial scale is connected with accommodation, and the kind of taken drugs.
- 8) Paranoia scale is connected with occupation, accommodation, and education.
- 9) Psychological inadequacy (PI) is connected with accommodation, education, drug type, drug-taking method.
- 10) Schizophrenia scale is connected with occupation, education, being married, and drug kind.
- 11) Mafia scale has no connection with the demographical items.

Based on the results indicated on table 5-1, which has been obtained after administering Fisher's Precise Test, it's seems that:

- a) Hs is the most important subscale of MMPI which has been comprehensive in discriminating meaningfulness of the connection among collected demographical data, having meaningful connection with 6 items out of studied 7 ones.
- b) After Hs, there are D and Pt, which each has meaningful connection with 4 items, and then K, F, Pd, and Sc, which each has meaningful connection with 3 items, and finally, L, HY, and Pa, which each has meaningful connection with 2 items.
- c) Significantly, Ma has no connection with any of the items.

It seems that the results of this research are consistent with those of Dr. Jonaib Ahmadi (2003) on the addicts of Pirbanan center in Shiraz.

Questions 2 - 12:

In order to show the addicts' antisocial characteristics, paranoia, depression, mania, hypochondria, hysteria, psychological inadequacy, schizophrenia, lying, correction, and infrequency based on Minnesota Personality Inventory, their

psychological profile has been drawn as following. Significantly, the profile of all the addicts follows this model, whether addicted to opium, or heroin, or crack, or multi-drugs.

As it is seen, the direction of the profile indicates a kind of addiction-personality disorder that has the following specifications:

1- F is higher than L and K.

- 2- D is higher and Ma is lower.
- 3- Hs and HY are lower than D.
- 4- PT and PD are higher than PA.
- 5- In general, there is a kind of acclivity and declivity from one factor to another, which confirms a kind of addiction-personality disorder.

Table 1-5: two-dimensional table of MMPI subscales and demographical data of the sample addicts based on meaningfulness of the results of the Fisher's Precise Test

drug-taking method	drug kind	income	being married	education	accommodation	job	data demography of scales
				+	+		L
+				+	+		F
			+	+	+	+	K
+		+	+	+	+	+	HS
+			+	+	+	+	D
	+				+		HY
+				+	+	+	Pd
				+	+	+	Pa
+	+			+	+		Pt
			+	+		+	Sc
							Ma

Table 1-6: performance of the cases based on risk-taking limits

total		much risky		risky		little risky		scale of risk-taking
100	256	0.39	1	60.54	155	39.06	100	lying
100	256	21.09	54	69.14	177	9.76	25	correction
100	256	2.73	7	17.96	46	79.29	203	infrequency
100	256	22.26	57	62.89	161	14.84	38	hypochondria
100	256	57.42	147	39.84	102	2.73	7	depression
100	256	12.5	32	47.26	121	40.23	103	hysteria
100	256	33.98	87	60.56	155	5.46	14	anti-social
100	256	12.5	32	68.75	176	18.75	48	paranoia
100	256	26.17	67	70.31	180	3.51	9	psychological inadequacy
100	256	28.12	72	61.32	157	10.54	27	schizophrenia
100	256	7.81	20	73.04	187	19.14	49	mania

Explanation:

- 1 Considering the fact that single scores lack interpretative value, the above table was included in profile, based on standard measurement, in order to highlight the scores at the points of 30%, 50%, and 70% like standard profile.
- 2 On mania scale, 7.81% of the cases have performed on the abnormal level, avoiding the society's norms and laying in frontiers of personality disorder.
- 3 On schizophrenia scale, 28.12% of the cases have performed on the abnormal level, avoiding the society's norms and laying in frontiers of personality disorder.
- 4 On psychological inadequacy, 26.17% of the cases have performed on the abnormal level, avoiding the society's norms and laying in frontiers of personality disorder.
- 5 On paranoia scale, 12.5% of the cases have performed on the abnormal level, avoiding the society's norms and laying in frontiers of personality disorder.
- 6 On antisocial scale, 33.98% of the cases have performed on the abnormal level, avoiding the society's norms and laying in frontiers of personality disorder.
- 7 On hysteria scale, 12.5% of the cases have performed on the abnormal level, avoiding the society's norms and laying in frontiers of

- personality disorder.
- 8 On depression scale, 57.42% of the cases have performed on the abnormal level, avoiding the society's norms and laying in frontiers of personality disorder.
 - 9 On hypochondria scale, 33.26% of the cases have performed on the abnormal level, avoiding the society's norms and laying in frontiers of personality disorder.
 - 10 On infrequency scale, 2.73% of the cases have high scores that express idealistic and extravagant description of their jobs.
 - 11 On correction scale, 21.09% of the cases have high scores that express a kind of self-defense.
 - 12 On lying scale, only 0.39% of the cases have high scores that express their effort to give a positive and unreal description of themselves.

It is emphasized again that none of the mentioned scales has interpretative value by itself unless they are interpreted in combination and based on psychological profile or the drawn one with activities and deactivities on it. In this regard:

- 1 The scale of D has allocated the highest degree to itself in psychological profile of the cases. This result is in accordance with the results of other researchers, i.e. high scores on D scale in most mental patients, including addicts, are observed. This shows a sense of inferiority and the need to satisfy desires immediately. Most of the people who get high scores on this scale are aloof, unsociable, and shy and do not show the necessary flexibility in social relations.
- 2 The cases performance on a combination of Sc, D, and Pd scales indicates the accordance of obtained data with Greeve's studies. In addition to the mentioned interpretation, such a combination shows clinical description of individuals who tend to be self-irritating, and revolt against parental and social discipline, regarding themselves as victims of their families. Unable to/avoiding internalizing its values and norms, they feel that they are separate from the others and don't belong to the society they live in.
- 3 In Pitle's studies, too, in accordance with the results of this research, high scores have been obtained.
- 4 When normalizing MMPI test on addicts, the research done by Okhovvat in Iran, also showed that the addicts' scores on Sc, Pd, and D scales, anxiety graph, tendency to

depression, feeling lonely, poor emotional relations, disgust and feeling inefficiency. Such a performance is higher than normal community is and lies at a critical point. These results have been shown in this research, as well.

- 5 It's noticeable that low scores of the cases on PA, HY, and MA scales are in accordance with primary normalizing MMPI test on addicts, done by Okhovvat and assistants. Their interpretation evidently shows lack of psychological defense when responding. In other words, addicts answer less defensively than ordinary people do. This is probably because of the fact that addicts, when taking tests, have a definite and known status as an addicted person and in fact they admit their problems; so they are less defensive when talking about their inefficiencies, weak points, and abnormalities.
- 6 Persker is one of the researchers who tried to place addicts in psychiatric defined categories. At the end of his studies, he concludes that 88.1% of the cases are socio-panic, 6.8% are neurotic and 5.6% are psycho-panic.
- 7 Hakimian and Rashan studied on 112 heroin addicts who were confined to bed Belvir Hospital also confirmed the existence of speculative signs of psycho-panic in them.
- 8 Okhovvat, Barahani, Tariqati, Gregorian, and Vahhabzadeh used MMPI test to study on 103 addicts. Confirming diagnostic value of the test, they reported that the studied addicts belonged to 20-40 age group, among which 61% were addicted to heroin, 20% were addicted to opium, and the remainder to other addictives. In that study, too, the sample addicts showed psych-panic and psycho-neurotic features. Their scores on scales of anxiety, tendency to depression and loneliness were the biggest numbers, similar to what we find in western societies. Their studies showed that Iranian addicted men have a lot of anxiety, feel strongly unsafe and inefficient, and care deeply about their physical changes. Early depression, deep emotional instability, hopelessness, loneliness, and feeling an obstacle between them and other people are some of their important results.
- 9 As the obtained data in this research shows, co-morbidity is one of the serious problems of the sample addicts. This fact has been

proved through a number of researches. For instance, according to clinical observations in most cases there is a relation among taking drugs and some abnormalities, psychological disorders, and emotional, behavioral, and moral problems, such as behavioral, anti-social, and tow-polar disorders, depression, anxiety, and Posttraumatic stress disorder (PTSD). (Bovine, 1992; Weinstein, 1993; Bruner, 1996; Kidrowkev, 1996; Kohn 1991; Kohn, 1991; Kesler, 1996; Nelson, 1996; Glosney and Kumis, 1992; Soundson 1998, and Clark and Handrose, 1997)

- 10 Furthermore, Kidrov (1996) and Nelson (1996) reported that existence of a disorder in addicts, such as depression, will be a practical diagnostic criterion for other kinds of disorder. Therefore, the prevalence of this co-morbidity has several other implications. In addition to addiction, addicts face accompanying illnesses and need more concise and longer clinical and medical care, which, in turn, makes their clinical developments critical and treatment period longer. (Schmitt and Biglu, 1996).

In serious works on drug abuse and psychological disorders (Tantle, Glants, and Meyers, 2002) three models are presented for correlation between addiction and accompanying disorders:

- a) Psychological disorders resulting in drug abuse
- b) Drug abuse resulting in psychological disorders
- c) Risky factors resulting in both drug abuse and psychological disorders

Recently Glants, Inburg, and Hinser (2002) have talked about a fourth model, combining the above three models and suggesting an interpretation to each cases of accompanying illnesses.

- 11 Valance Dandle (1919) has done a research on effects of depression syndrome, drug-distribution networks, and group activities on joint injection of drugs among street-wanderers. The results show that depressed individuals are willing to take drugs and by residing in broad drug-distributing networks, show much more tendency towards joint injections. This hypothesis says that it is possible that the effect of depression on joint injection is practiced through drug-distribution networks.
- 12 A great number research, including Gudman and Kapidman (2000) Alabama Birmingham researchers, Jhanett Aderian and assistants (2002) has proved the relation between

depression and drug abuse, which has shown in this research.

- 13 Some of Iranian researchers including Khoshnevis (1974), Heidarian (1997), and Barmas (2003) have also reached the same conclusion.

Conclusion and application of the results

- 1 1- According to the researches done, including the result of this research, MMPI questionnaire is a proper criterion to diagnose psychological and personality disorders and is reliable and of high importance to be given to addicts.
- 2 Based on obtained results and after checking other countries' reports on this issue in different years, we can say that form of addicts' personality follows approximately the same procedure in different nations through many years and resulted psychological profile of the addicts indicates that some of disorders can be regarded as risky factors of addiction. Even after diagnosing emotional disorders, therapists should examine cases for drug abuse.
- 3 According to the results of this research and other available records, whenever in a specialist clinic, the scores of a case on Sc, Pd, and D scales are high and on K and L scales are low, it is necessary for clinical specialists to examine him/her for addiction as a co-morbid disease.
- 4 According to the table 2, in chapter 4, about the reasons of the sample addicts' tendencies towards drugs, and their demographical information, an individual with the following features is very likely addicted: Self-employed (whose parents are also self-employed), having his/her own house, having finished at least elementary or at most high school, single, earning 4000000 Rials a month, with record of chronic and serious physical and psychological illnesses (esp. anxiety and depression), having addicted close/distant relatives, having conviction record, with easy access to drugs, under high influence of peer groups with distinguished (and usually defective) curiosity, aid without basic living skills.
- 5 If the combination of the above demographical data, along with obtained data from MMPI test, esp. with high scores on Pt.D, Pd, Pd, Sc scales, psychological psychiatric, and clinical services related to drug abuse must be taken into account and geu available.

Recommendation

- 1 Since addiction has followed approximately constant tendency during recent years, it is recommended in future researches instead of repetitive discussion about the reasons of taking drugs, risky and protective of drug abuse are investigated.
- 2 Since most of previous researches have focused on social/group factors, future researches should focus on inter-person addiction factors.
- 3 Regarding demography and specialist tests and questionnaire, clinical picture of addiction should be defined on different levels of hygiene, treatment, and referring.
- 4 This research should be applied as new questionnaire format along with clinical interviews so that specialists can diagnose more accurately.
- 5 Analysis of factors of drug abuse is necessary and must be done through modeling popular personality models.

References

- 1-Miller; Norman (2002) Addiction Psychiatry Current diagnosis and treatment, I(I).
- 2- Eviedman; herman (2000) Drug and Abuse, New York.
- 3- Kaplan and Sadock (2003) Synapsis of psychiatry,, Ed 9th. New York.
- 4- Keltner; Norman L.Schwecke; Lee Hilyard, Bostrom; Carol E. (2003) Psychiatric Nursing. Ed 4th, Mosby.
- 5- Gelder; Michael Graham. et al (1999) Oxford coretext (psychiatry).Ed 2nd.
- 6- Fontaine; Karen Lee (2003) Mental Health Nursing. Ed 4th.
- 7- Boyd; Mary Ann (2005) Psychiatne Nursing. Ed 3rd, lippincott Willuams and wulkins.
- 8- Halgin; Richard F., Whitbourne; Suankrauss (2003) Abnormal Psychologs, Ed 4th.
- 9- Garson; Verna Benner (2000) Mental Health Nursing, Ed 2nd.
- 10- Gipriano; Lois A, Psychoanalytic Perspective on substance abuse, Journal of social w,rk in health care, (2003) vol 215(3), 9-46.
- 11- Gompton; Wilson M., et al (2002) the role of psychiatric disorders in Predicting drug dependence treatment come, the American J. ofpsydicting, Washington, vol 160(s), 890-6.
- 12- Pape; Hilda, Ingeborg; Rossow (2004) A longitudinal study of ecstasy and other drug Norwegian youth, Journal of drug issues, vol 34(2), 389-419.
- 13- Abadinsky; Howard,(2001) Drugs : an inrtoduction, Ed 4th.
- 14- shamlu, saeed, *clinical psychology*, Tehran, Roshd Publications, 2003.
- 15- Korddmieza, Ezzatollah, 2nd year, vol. 2, p 190.
- 16- Millanifar, Behrooz, Tehran, Toos Publications, 2000.
- 17- Mohammadi, Masud and Dehqanpur, Mohammad, Tehran, Ayeneh Ketab Publications, 2003.
- 18- Owrang, Jamileh, Tehran, Ershad Ministry Publications, 1998.
- 19- Sekhavat, Jafar, 2nd vol., Tehran, Khordad 2003.
- 20- Kamkar,Manuchehr and Qanbari, Abbas, pp. 54-57, 2002.
- 21- Nemati, Farshad, 2nd vol., pp. 279-296, 2002.
- 22- Hashemi, Ali, Tehran, Rasanesh, 2004.
- 23- Komeil, Bahram, 2nd year, vol. 5, pp. 31-46, 2003.
- 24- Hakim, Abdolhamid, PhD. theses, Mdical Faculty of Tehran University, 2002.
- 25- Zakariyae, Mohammad Ali, Tehran, 2002.
- 26- Mortazavy Qahi, Ali, Tehran, Ayeneh Ketab Publications, 2002.
- 27- Nooranipur, Rahmatollah, 2nd year, vol. 6, pp. 13-55, 2004.
- 28- Asaadi, Hassan, 2nd vol., PP. 109-149, Khordad, 2001.
- 29- Mohammadi, Ataollah, 2nd vol., pp. 225-247, Tehran, 2001.
- 30- Hashemi, Ali, Tehran, Niayesh Publications, 2004.
- 31- Ettikson, Rita and assistants, 2nd vol., translated by Rafieei and assistants, Tehran, Arjmand Publications, 2001.

09/03/2012

Assessment of suitable Location for Construction of groundwater dams

Leila Sharifi¹, Mohamad Karami²

¹ Department of Civil Engineering, Abadan Branch, Islamic Azad University, Abadan, Iran

² Department of Civil Engineering, Dehloran Branch, Islamic Azad University, Dehloran, Iran

* Corresponding author. Leila Sharifi

Abstract: Crisis of maintaining, supplying and optimal operating and conservation of natural water resources is one of the largest hydrological problems in the country. In fact groundwater is part of surface water that either reaches to the surface naturally through springs or is extracted from groundwater tables (aquifers) by well, infiltration gallery etc. These waters are one of important sources of supplying drinking water and agriculture water that does not need treatment. Scientific and practical designing and planning for obtaining and feeding groundwater network can prevent destruction of these sources and stabilize them without causing any environmental damages. Our country, as one of regions with low water level and nearly hot and dry climate, needs protection of groundwater resources and construction of groundwater dams, including infiltration galleries, traditional aquifers and flumes, can help optimal operation of water, protection of groundwater and prevention of draught in agriculture sector.

[Leila Sharifi, Mohamad Karami. **Assessment of suitable Location for Construction of groundwater dams.** *Life Sci J* 2012;9(4):1233-1236] (ISSN:1097-8135). <http://www.lifesciencesite.com>. 184

Key words: groundwater dams, surface waters, operation, hot and dry climate.

Introduction

In many areas of our country, intensive changes occur in surface waters and winter seethe of water of rivers and streams decreases in summer and seasonal and permanent streams become dry paths, which causes intensive low water and economic and social problems. Considering weather fluctuations and climatic changes in some seasons of year in various areas, using watershed projects, water resource management and optimal operation of these natural sources by applied approaches is evaluated. An important step for solving problems of hot and dry climates is construction of groundwater dams in suitable points. Therefore, given the situation of groundwater tables, an appropriate method for obtaining stable productivity and development of agriculture is reclamation and regeneration of natural resources in the mentioned points.

In dry and hot areas, groundwater always has great importance due to low precipitation levels and its resultant run-off and high level of evaporation in these points.

From past till now, due to low water problems in arid areas, man has considered extraction of water from underground layers and has directed water to farmlands for drinking and agricultural purposes using well, infiltration gallery and modern method of groundwater dam construction.

In arid and semi-arid areas with considerable potential for development of agriculture, increasing production, reforestation and reclamation of pastures, water is the most important for this development and in some seasons, floods cause much damage and destruction. Therefore, one of the most essential aims

of this study is to examine groundwater dams, suitable place for them and their importance in agriculture, drinking water and development.

Groundwater Dam Definition

Groundwater dams are hydraulic structures that block natural flow of groundwater and store water underground. Groundwater dam is structurally different from normal dams and its height does not exceed river level. An underground reservoir is created by excavation of river bed and filling it with impermeable material and soils and creating impermeable layers against flow.

History of Groundwater Dams in Iran and World

History of using groundwater dams in Iran and all over the world dates back to old civilizations. For example, groundwater dams in Sardina Island were constructed in Roman era. In 1983, groundwater dams were constructed in bed of Boelivi River in small scale to prevent draught (World Water, 1984).

In China, using groundwater dams along with other grand plans of water supply for stable development of rural areas in various scales and compatible with environmental conditions of each area was performed successfully. In Safavieh era in Iran, in order to increase water of mother well Kanat Vozoran in Meime, Isfahan, water of other kanats were deviated to it. But, now groundwater dams are used in most points of the world due to their benefits compared to surface dams.

Groundwater Dams Implemented in Iran

In Iran, where precipitations average does not exceed 240 to 250 mm, groundwater reservoirs are limited and rainfall distribution is unequal at country level. History of groundwater dams construction in Iran dates back to 1370 which was performed in Kahnooj, Kermaan, by Jihad-e-Sazandegi Ministry in order to supply urban drinking water. This dam, which was constructed at 4% slope with clay core and 40 m width and 12 m height, had 1000 m³ storage volume. Other works done include:

Koohrez, Damghaan, which was constructed in two phases: 1) from bottom to height of 4 m in form of brick wall with tar cover, and 2) other parts of wall to the ground level with compact clay.

Toye-Davar groundwater dam, which is constructed with stone and mortar to 5 meters depth and rest of it is made of concrete. For protection of isogam layer, a 20 cm brick wall was built and gravel material was used inside dam reservoir.

Dams currently under construction include dams in Makoo, Azabayejan-e- Gharbe and Kharanegh in yazd. One of the odests dams of world is constructed in Meime Isfahan and near Kashan. This groundwater dam is 9 meters high and able to store nearly 270,000 m³ water for usage in irrigation and draught periods. There are some other dams under construction in the country now including groundwater dam Kharanegh in Ardakan, Yazd. Several groundwater dams have been operated recently. In other countries, including Thailand, Tanzania, China, Japan and Brazil, there are some constructed dams which are mentioned below.

Purpose of Groundwater Dam Design

Intensive reduction of water level in some points has caused water level to reduce over 100 meters. One goal of groundwater dams is to collect groundwater and prevent it from being wasted and being mixed with saline water, and this way, level of groundwater can be elevated again which is performed in four areas:

Drinking water supply

- 1- Water resources management (such as blocking some springs or infiltration galleries and directing their water toward main spring or mother well)
- 2- Preventing saline water from extending into groundwater, such as coasts and salt plains
- 3- Environmental such as diffusion of pollution or nuclear radiations and their adverse effects on groundwater

Groundwater dams have some benefits compared to surface dams, including:

- Much lower construction cost
- Dam is nearer to consumption point
- Prevention of water reduction due to surface evaporation
- Water of groundwater dams is cleaner due to disinfection of microbes and viruses that usually exist in waters behind dams.
- Distribution of surface water by channels is more expensive.
- Construction technology is much simpler.

Design of Groundwater Dams

Suitable Location

First step in construction of groundwater dams is locating. Since groundwater dams can't be constructed in every place, the best location must be considered for construction according to characteristics and climate of the region. In order to locate suitable areas for construction of groundwater dams in the desired area, decision making support system has been used. This support system has been used in three phases. In the first phase, unsuitable areas for dam construction are identified using elimination measures and suitable site for construction of groundwater dams is determined. In the second step of decision making in each site, the most suitable canyon for groundwater dam construction is specified. In the third step, axes identified in the second step are compared to each other using hierarchical analysis method and by considering evaluation measures. Finally, the most suitable axes are identified for closer evaluations.

Groundwater dams is many arid and semi-arid areas of the world have been paid attention in recent years for development of groundwater resources and prevention of water waste. Design implementation method is similar to sealing system of surface dams' foundations. The most important parameters in determination of water height on groundwater dams are discharge, dam height, initial hydrostatic level, hydraulic conductivity coefficient of aquifer, dam thickness and slope of aquifer bottom.

The location should have following climatic conditions:

It should have arid or semi-arid climate.

Rainfall should be low or irregular or occur in seasons when it is not needed.

Since groundwater dams should have more storage volume and less leakage by least cost, they are usually constructed with 3 to 4 meters height in a location where ground slope is less than 5%. This characteristic is seen in uniform and narrow rivers or valleys.

In some cases, suitable natural conditions act like a groundwater dam and blocking effect of natural

barriers (such as protrusion of bed impervious layer) can play a significant role in locating and saving costs.

In addition to the above topographic conditions, ground should have the following characteristics too:

- Impervious bed with low distance from surface
- Highly porous ground layers with sufficient thickness for storage of more water.
- In tables with fine grained material, there is usually enough water inside soil void space but possibility of its operation is limited due to the risk of discharge reduction.
- Least distance to consumption area
- The stored water will not be polluted due to human activities.
- Salt level of soil and annual precipitation should be examined. Presence of salt layers causes stored waters to become saline. Although recent researches in Adelaide, Australia, have shown that slow flow of fresh water limits its mixing with saline groundwater, evaluation of annual precipitation is important for maintain sufficient flow and preventing dam from being endangered.

Dam Construction

First step in dam construction is digging a ditch perpendicular to drain path or river bed, which is performed by human force due to low depth of implementation operation. In dry sand alluviums with low cohesion and sand areas, trenches walls can collapse due to instability of slopes, which makes digging problematic. Nevertheless, sand alluviums are suitable sites for dam construction because groundwater level is seen in them easily and they keep water level low by pumping. Time of groundwater dam construction is usually at the end of dry season when groundwater level is low and implementation operation is done easily. Materials used in dam construction are determined according to three parameters: 1) borrow material in area, 2) consumed costs, and 3) ease of performing work. However, various building materials are used in dam construction and only sealing dam walls is needed.

Types of Dams in Terms of Construction and Placement on the Ground

1 – Natural

Impervious layers, as mentioned before, consist of stone or clay and water movement is slowed or stops in contact with them. These layers, like earth surface, have low and high points that result from fault motion, volcanoes, crustal motions etc. When groundwater encounters a high impervious layer during moving on earth slope, it stops moving and

accumulates behind the impervious layer that acts as a groundwater dam.

2 – Artificial

These are man-made dams which are divided into two groups buried and semi-buried: a) buried: 1) near ground surface, 2) deep in earth.

Types of Dams in terms of Material:

In the following, two types of material used in dam construction are mentioned:

Compact clay:

Using clay is a common method that does not need skilful human force. Clay is placed in low thickness layers and then is compressed. Because of groundwater flow, there is a possibility of clay surface corrosion. Therefore, plastic plates are used for protection of walls. Trench filling operation is performed by compressive tools and with suitable humidity. If groundwater storage reduces in dry season, crack can develop in dam. Thus, by constructing wall with suitable thickness in order to keep moisture in core area, this can be prevented even in long dry periods.

Plastic or bituminized plates:

In this method, a plastic core is used for sealing whose plastic type is usually poly ethylene and in terms of material costs, is the lowest cost method. In using this method, it should be considered that materials such as mud must be used for covering two sides of the plate to prevent holes formed by sharp stones. Also, for protection against effects of contraction and expansion, temperature changes should be evaluated. If a hole is created in the plate, it can be patched with another plastic plate by a suitable cohesive material.

Water Extraction

Water extraction operation is performed by two methods: gravitational and well drilling. If operation point of people is downstream of dam and topographic conditions are present, water can be extracted from reservoirs gravitationally. In this method, water is extracted through a pipe which is on dam body and directs water gravitation force to downstream. The well which extracts water from groundwater dams is inside the reservoir and is drilled near rivers in order to prevent it from being degraded by floods (operation by well).

Conclusions

Groundwater dams can be a cost effective method for using groundwater due to their low cost, easy construction method, clean water storage and

many other benefits they have compared to surface dams and due to arid and semi-arid climate of Iran. Groundwater dam is constructed preferentially on an impervious layer to create larger volume of water. Groundwater dams can also be constructed on rivers without impervious layers, but they may store less water. Therefore, suitable locations for construction of groundwater dams are determined by interpretation of natural processes of region such as alluvial fans, valley of narrow seasonal rivers and lands with less than 8% slope.

It is expected that construction of groundwater dams will be paid more attention in our country.

References

- 1- Management of groundwater resources, Abdollah Taheri Tizro. Elham Roshani. Kermanshah, Razi University, 1388.
- 2- Hydrology of soft and hard formations, Sadollah Velayati, Mash-had University Press, 1387.
- 3- Maghrebi Mehdi and Borumand Puyan, 1383, 11th Conference of Civil Engineering Students, Hormozgan University.
- 4- Iran, superpower of water engineering history in world, Kamraan Emami.
- 5- Groundwater dam, a new technology of groundwater resources development, regional water resources of Isfahan.
- 6- Artificial feeding using groundwater dams, Dr. Reiterz.
- 7- Groundwater dams for water supply at small scale, Tabatabayee Yazdi. Saeed Nabi Pei Lashkarian, 1382, Press of watershed management and soil protection research center.
- 8- Groundwater Dams, A.K. Nelson, translated by Bagher Yazdani, Isfahan University Press.
- 9- Civil Engineering Weblog.

10/9/2012

Treatment of the Subretinal Hemorrhage by the Use of Deep Periocular Injection of Bevacizumab ---- A Safer Method

Chih-Yaun Yang¹, Kuang-Jen Chien², Tsung-Hsung Chang³, Ren-Jy Ben⁴, Jen-Hsiel Lin⁴, Chi-Ting Horng^{1,5}. *

¹ Department of Ophthalmology, Kaohsiung Armed Forces General Hospital, Kaohsiung, Taiwan, ROC

² Department of Pediatrics, Veteran General Hospital- Kaohsiung, Taiwan

³ Department of Surgery, Kaohsiung Armed Forces General Hospital, Kaohsiung, Taiwan, ROC

⁴ Department of Medicine, Kaohsiung Armed Forces General Hospital, Kaohsiung, Taiwan, ROC

⁵ Department of Pharmacy & Graduate Institute of Pharmaceutical Technology, Tajen University, Pingtung, Taiwan, ROC.

*Corresponding author: h56041@gmail.com

Abstract:

Purpose: To evaluate the visual outcome of patients with subretinal hemorrhage after deep periocular injection of bevacizumab. **Methods:** Three patients having subretinal hemorrhage with poor vision were treated with at least one deep periocular injection of bevacizumab (0.3 ml). Patients underwent a complete evaluation at the baseline and follow-up visits. This evaluation included the Snellen best-corrected visual acuity, fundus biomicroscopy and ocular coherence tomography. **Results:** The follow-up point ranged between 3 and 6 months. Improvement of vision was observed, and they all had better visual acuity. The subretinal hemorrhage cleared in all eyes and no complications were noted. **Conclusion:** Deep periocular injection of bevacizumab was safer and effective in the treatment of subretinal hemorrhage. It can induce effective regression of retinal neovascularization and rapid clearance of the subretinal hemorrhage. It may enhance the absorption of hemorrhage with subsequent deferral from surgery. [Chih-Yaun Yang, Kuang-Jen Chien, Tsung-Hsung Chang, Ren-Jy Ben, Jen-Hsiel Lin, Chi-Ting Horng. **Treatment of the Subretinal Hemorrhage by the Use of Deep Periocular Injection of Bevacizumab ---- A Safer Method.** Life Science Journal. 2012;9(4):1237 -1241] (ISSN:1097-8135). <http://www.lifesciencesite.com>.

Keyword: periocular injection, bevacizumab, subretinal hemorrhage

1. Introduction

Bevacizumab (Avastin, Genentech) is the first Food and Drug Administration (FDA) approved therapy applied intravenously as an adjunct for the treatment of metastatic colorectal cancer [1]. It also improves progression-free survival rates in patients with previously untreated metastatic breast cancer. Bevacizumab is a monoclonal antibody that binds all isoforms of vascular endothelial growth factor A (VEGF-A). It is a potent inhibitor of angiogenesis, and has also been used effectively in the treatment of neovascular ARMD (age-related macular degeneration) [2]. Intravitreal injection of anti-VEGF agents has been reported effective in inducing the regression of new vessels in proliferative diabetic retinopathy (PDR) [3], and neovascular glaucoma (NVG) [4].

Intravitreal injection of anti-VEGF drugs may be considered a new therapeutic option for patients with submacular hemorrhage. The clearing effect has been attributed to bevacizumab [5]. Subretinal hemorrhage is a complication of various ocular pathologies such as ARMD, trauma, myopia and retinal artery macroaneurysm. It may cause a sudden loss of vision [6]. The rate of spontaneous resorption is low, and the overall visual prognosis of

untreated subretinal hemorrhage is poor with patients losing on average 3.5 lines of visual acuity after 3 years. Removing the subretinal blood clearly with treatment of the underlying cause might allow for better visual recovery. However, as clearing of the media might take some time, we decided to evaluate the outcome of the patients with subretinal hemorrhage by means of deep periocular injection of bevacizumab.

2. Material and Methods

Material

From January 2012 to August 2012, consecutive cases with subretinal hemorrhage were treated with deep periocular injection of bevacizumab. Patients with a history of preoperative and postoperative anticoagulant therapy, or with a history of blood diseases associated with abnormal coagulation were excluded. The study was approved by the institutional research board of Kaohsiung Armed Forces General Hospital. The procedures were performed after informed consent for the patients was obtained.

After proper disinfection using 5% povidone-iodine and deep periocular injection of bevacizumab (0.3 ml) was carried out under topical anesthesia.

After treatment, patients were followed at regular intervals. The Snellen best-corrected visual acuity measurement, intraocular pressure, slit-lamp examination and ocular coherence tomography. were performed at each follow-up visit. Data including the extent of the subretinal hemorrhage and the cleaning of the subretinal hemorrhage were recorded.

Case Reports

Case 1 :

A 70-year-old female patient presented with decreased vision in the left eye over a two-week period. The best-corrected visual acuity (BCVA) in the left eye was 0.05. The fundus of the eye showed massive subretinal hemorrhage (Fig 1A). Optical coherent tomography (OCT) suggested a large pigmentary epithelial detachment (Fig 2A). The patient was treated with a deep periocular injection of avastin (0.3 cc) three times every month. Three months later, no inflammatory cells were present in the vitreous and the BCVA returned to 0.5. The color fundus and OCT also revealed the normal images (Fig 1B, Fig 2B).

Case 2 :

An 80-year-old female presented with sudden diminution of vision in the right eye which she had been experiencing for one month. The right eye was 0.1. The fundus revealed a subretinal hemorrhage near the macula (Fig 3A). She received a deep periocular injection of avastin (0.3 cc) two times every month and the vision returned to 0.7 after four months. At the same time, no apparent complications were found. The subretinal hemorrhage had also disappeared after the 4-month follow-up. (Fig 3B)

Case 3 :

A 70-year-old female patient presented with decreased vision in the left eye over 1 week. Her vision was limited to seeing only a counting finger. We found a mild vitreous hemorrhage and a subretinal hemorrhage in the posterior segment (Fig 4A). Then the patient was received with 0.3 cc avastin by the deep periocular injection three times every month. After regular follow-up for three months, the VA had increased to 0.8 with normal anterior and posterior segment findings (Fig 4B).

3. Discussion

Bevacizumab (Avastin, Genentech Inc. San Francisco, CA), is a full length humanized monoclonal antibody to VEGF; it was approved by the Food and Drug Administration for the treatment of colorectal cancer. It can inhibit both types of VEGF receptors: VEGFR-1 and VEGFR-2 [7] . It

has recently shown to enhance the clearance of vitreous hemorrhage and to induce the involution of retinal neovascularization with no reported complication. It has also been tried in the treatment of macular edema caused by the central retinal vein occlusion [8] . Anti-VEGF substances have to be injected intravitreally repeatedly and at relatively short intervals of 4 to 6 weeks.

Vascular endothelial growth factor (VEGF) plays an important role in many diseases of the posterior pole that are characterized by macular edema and/or intraocular neovascularization. Such diseases include proliferative diabetic retinopathy (PDR), diabetic macular edema (DME), neovascular glaucoma, retinopathy of prematurity, choroidal neovascularization (CNV) and retinal vein occlusions. For example, bevacizumab resulted in the marked regression of neovascularization and rapid resolution of vitreous hemorrhage within several months [3] . Bevacizumab may also offer a therapeutic benefit including antipermeability and antiproliferative effects. However, as with all antiangiogenic compounds, intravitreal injections have to be repeated frequently for as long as the disease process is active, leading to high rates of repeat injections [9] .

To our knowledge, subretinal hemorrhages may occur from a variety of etiologies, including age-related macular degeneration (ARMD), trauma, intraocular tumors, sickle cell disease, retinal tear in primary rhegmatogenous retinal detachments and complications of scleral buckling procedures [10] . It may damage the sensory retinal tissue by means of the limitation of the passage of nutrition to the retina [11] , shrinkage of the outer retinal layers owing to clot formation, and the release of toxic substances such as fibrin, iron, and hemosiderin [12,13] . Toxic effects of subretinal blood can be evidenced 24 hours after the occurrence. The literature included a few reports describing subretinal hemorrhage management by surgery. Wade et al demonstrated the subretinal blood clots were treated with pars plana vitrectomy combined with internal drainage [14] . Unfortunately, poor visual outcome was found. Subretinal injection of recombinant tissue plasminogen (tPA) during pars plana vitrectomy followed by an intravitreal gas tamponade was proposed by Haupt et al [15] . Until now, Chawla et al. proposed that the intravitreal tPA and perfluoropropane gas infusion for the treatment for submacular hemorrhage. The tPA would enzymatically liquefy the blood, which would then be pneumatically displaced inferior in the subretinal space without vitrectomy [16] .

Characterization of the molecular and cellular processes involved in vascular growth and cellular and hypermeability has led to the recognition that the angiogenic growth factor and vascular permeability factor VEGF play pivotal role in the retinal microvascular complications of subretinal hemorrhage. Thus, VEGF represents an important target for therapeutic intervention in this condition. Recently reports attested to the benefit of bevacizumab were used in the treatment of subretinal hemorrhage.

Over the last decades, the use of intravitreal injection (IVT) has gained increasing acceptance in the therapeutic management of many intraocular diseases, affecting the posterior segment. For example, we can use the intravitreal injection of antiviral agents in treating the cytomegalovirus (CMV) retinitis. In addition, IVT injection of various gases (SF₆ or C₃F₈) has been used for the management of retinal detachment in the setting of pneumatic retinopexy. Recently IVT triamcinolone acetonide (Kenolog) injection is under investigation for a number of disorders, including macular edema and retinal edema and retinal neovascularization [17] .

The potential advantages of IVT injection have been become more widely appreciated and the number of possible applications has been grown. With over 15,000 annual IVT injections worldwide, bevacizumab is rapidly becoming one of the popular methods in the treatment of many diseases. However, questions have arisen regarding risks associated with the route of administration. Several potential complications of IVT can be vision-threatening and even life-threatening. Surprisingly, systemic adverse events were reported. Anti-VEGF agents gain access to the systemic circulation following an intravitreal injection. Systemic blockade can give rise to various complications. These may include acute elevation of systemic blood pressure, epistaxis, hemoptysis, proteinuria, delayed wound healing after surgery, and impaired reproductive function [17,18] . Other severe problems included the cerebrovascular accidents, myocardial infarctions, iliac artery aneurysms, toe amputations and deaths [19] . In addition, as many as 5% of all patients using systemic bevacizumab in combination with chemotherapy may have an increased risk of developing a serious or fatal thromboembolic event.

Ocular complications included increased intraocular pressure, cataract, bacterial endophthalmitis, tractional retinal detachment, uveitis, rhegmatogenous retinal detachment and vitreous hemorrhage [20] . Some of these problems may be solved by lowering intraocular pressure

agents, topical steroids and even further surgery. However, the possibilities of vision loss may be threatening to the patients. For example, bacterial endophthalmitis is an expected and dreaded complication of any intravitreal injection. The rate varies from 0.04% to 0.33% Sterile technique and antisepsis with instillation of topical povidone iodine 5% into the conjunctival fornix prior to an intravitreal injection may reduce the risk of endophthalmitis [21] . We also cannot ensure the safety of IVT injection. Another troubling complication is tractional retinal detachment. After the IVT injection, the neovascularization may regress. We found that the resulting fibrous scar tissue led to the development or progression of tractional retinal detachment. This disease needed further complicated surgeries and the outcome was always bad.

Risk assessment of IVT injection is complex. Studies reporting risks for IVT cross a number of indications and underlying pathologic conditions. Moreover, the occurrence of complications directly related to the toxicity of administration compounds confounds estimations of the prevalence of complications related to the IVT injection procedure itself.

Another issue that has been addressed is the legal problem resulting from complications occurring with off-label therapy. Bevacizumab is not legally approved for intraocular use in Taiwan. Intraocular inflammation has been reported with intravitreal injection of bevacizumab. The possibility of myocardial infarction, stroke and even mortality may impact the relationship between patients and ophthalmologist. The doctors may be bothered by the annoying medical disputes.

In our reports, the use of deep peri-ocular and sub-tenon's injection was a safer approach. No ophthalmological and systemic complications were found. The pharmacokinetic characteristics of compounds of peri-ocular injection remained unknown and deserved further study. However, the technique may be another alternative.

4. Conclusion

Deep periocular injection of bevacizumab was effective in the treatment of subretinal hemorrhage without safety concerns. It can induce the effective regression of retinal neovascularization and rapid clearance of the hemorrhage. It can be used as an adjunctive with laser photocoagulation and to enhance the absorption of subretinal hemorrhage with subsequent deferral operation. This method was shown to be safer than intravitreal injection. Deep periocular injection may be another safe procedure.

Fig.1A : Fundus of the left eye showed massive subfoveal subretinal hemorrhage.

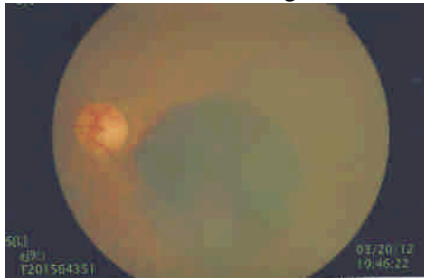

Fig.1B : The subretinal hemorrhage had disappeared dramatically after deep pericardial injection of avastin for three months.

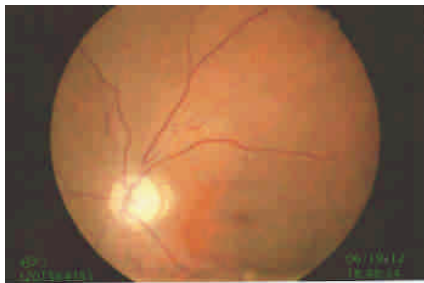

Fig.2A : Optical coherence tomography showing variable reflectivity of the retinal pigmentary epithelium suggestive of choroidal neovascular membrane with subretinal blood and large pigmentary epithelial detachment

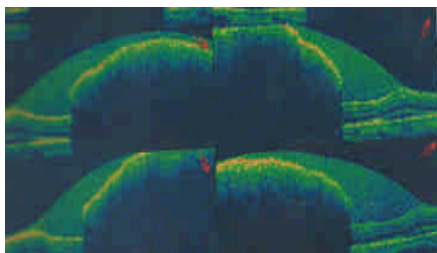

Fig.2B : Optical coherence tomography showing the relatively normal macular region after 3-month follow up.

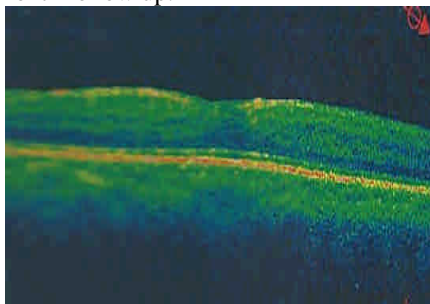

Fig.3A. : Red free image of right eye showing submacular hemorrhage along with pigmentary epithelial detachment.



Fig.3B. : Color fundus showed normal appearance after four months.



Fig.4A. : Red free image of left eye showing vitreous hemorrhage combined with subretinal hemorrhage.

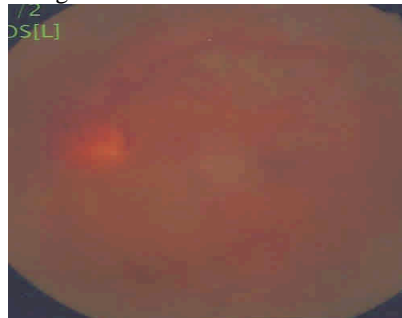
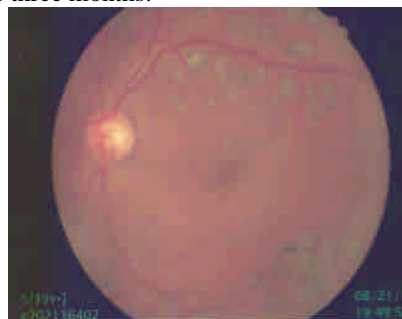

Fig.4B. : The color fundus revealed that the vitreous hemorrhage and subretinal hemorrhage had absorbed after three months.



Corresponding Author:

Chi-Ting Horng, M.D.

Department of Ophthalmology, Kaohsiung Armed Forces General Hospital, Kaohsiung, Taiwan, ROC

Department of Pharmacy & Graduate Institute of Pharmaceutical Technology, Tajen University, 20 Wei-Shin Road, Yan-Pu, Pingtung, Taiwan, ROC.

E-mail: h56041@gmail.com**References**

1. Yang JC, Haworth L, Sherry RM, et al. (2003) A randomized trial of bevacizumab, an anti-vascular endothelial growth factor antibody, for metastatic renal cancer. *N Engl J Med.*; 349: 427-434.
2. Bashshur ZF, Bazarbachi A, Schakal A, Haddad ZA, El Haibi CP, Nouredin BN. (2006) Intravitreal bevacizumab for the management of choroidal neovascularization in age-related macular degeneration. *Am J Ophthalmol.*; 142: 1-9.
3. Spaide RF, Fisher YL. (2006) Intravitreal bevacizumab (Avastin) treatment of proliferative diabetic retinopathy complicated by vitreous hemorrhage *Retina* ; 26: 275-278.
4. Davidorf FH, Mouser JG, Derick RJ.(2006) Rapid improvement of rubeosis iridis from a single bevacizumab(avastin) injection. *Retina* ; 26(3): 354-356.
5. Soliman W, Lund-Andersen H, Larsen M. (2006) Resolution of subretinal hemorrhage and fluid after intravitreal bevacizumab in aggressive peripapillary subretinal neovascularization. *Acta Ophthalmologica Scandinavica.* ; 84: 707-708.
6. Bennett SR, Folk JC, Blodi CF, Klugman M. (1990) Factors prognostic of visual outcome in patients with subretinal hemorrhage. *Am J Ophthalmol.* ; 109: 33-37.
7. Hurwitz H, Fehrenbacher L, Novotny W. et al.(2004) Ranibizumab plus irinotecan, fluorouracil and leucovorin for metastatic colorectal cancer. *N Engl J Med.*; 350: 2335-2342.
8. Rosenfeld PJ, Fung AE, Puliafito CA. (2005) Optical coherence tomography findings after an intravitreal injection of bevacizumab (Avastin) for macular edema from central retinal vein occlusion. *Ophthalmic Surg Lasers Imaging*; 36: 336-339.
9. Tolentino M. (2011) Systemic and ocular safety of intravitreal anti-VEGF therapies for ocular neovascular diseases. *Surv Ophthalmol.*; 56: 95-113.
10. Avery RL, Fekrat S, Hawkins BS, Bressler NM. (1996) Natural history of subfoveal subretinal hemorrhage in age-related macular degeneration. *Retina*; 16: 183-9.
11. Glatt H, Machemer R. Experimental subretinal hemorrhage in rabbits. (1982) *Am J Ophthalmol.*; 94(6) : 762-773.
12. Toth CA, Morse LS, Hjelmeland LM, Landers LB III. (1991) Fibrin directs early retinal damage after experimental subretinal hemorrhage. *Arch Ophthalmol.*; 109(5) : 723-729.
13. Bhisitkul BB, Winn BJ, Lee OT, et al. (2008) Neuroprotective effect of intravitreal triamcinolone acetonide against photoreceptor apoptosis in a rabbit model of subretinal hemorrhage. *Invest Ophthalmol Vis Sci.*; 49(9): 4071-4077.
14. Wade EC, Flynn HW Jr, Olsen KR, Blumenkranz MS, Nicholason DH.(1990) Subretinal hemorrhage management by pars plana vitrectomy and internal drainage. *Arch Ophthalmol.*; 108 : 973-978.
15. Haupt CL, McCune BW II, Jaffe GJ, et al. (2001) Pars plana vitrectomy, subretinal injection of tissue plasminogen activator and fluid-gas exchange for displacement of thick submacular hemorrhage in age-related macular degeneration. *Am J Ophthalmol.* ; 131(2) : 208-215.
16. Chawla S, Misra V, khemchandani M. (2009) Pneumatic displacement and intravitreal bevacizumab: A new approach for management of submacular hemorrhage in choroidal neovascular membrane. *Indian J Ophthalmol.*; 57(2): 155-157.
17. Jager RD, Aiello LP, Patel SC, Cunningham ET Jr. (2004) Risks of intravitreal injection: a comprehensive review. *Retina*; 24: 676-698.
18. Van Wijngaarden P, Coster D, William K. (2005) Inhibitors of ocular neovascularization promises and potential problems. *JMMA*; 293: 1509-1513.
19. Wu L Castaello-Castellanos MA, Quiroz-Mercado H, et al. (2008) Twelve -month safety on intravitreal injections of bevacizumab(Avastin): results of the Pan-American Collaborate Retina Study Group(PACORES). *Graefes Arch Clin Exp Ophthalmol.*; 246: 81-87.
20. Sharma S, Johnson D, Abouammoh M, Hollands S, Brissette A.(2010) Rate of serious adverse effects in a series of bevacizumab and ranibizumab injection. *Can J Ophthalmol.*; 47(3): 275-279.
21. Aiello LP, Brucker AJ, Chang S, et al.(2004) Evolving guidelines for intravitreal injections. *Retina*; 24 : S3-S19.

10/2/2012

Efficacy of intraumbilical vein (IUV) injection of oxytocin in active management of the third stage of laborFarideh Movahed¹, Reyhaneh Ramazan Nejhadi¹, Ezzatalsadat Haji Seid Javadi¹, Amir Javadi², Fatemeh Lalooha¹, Omid Mashrabi³¹ Assistan professor of Obstetrics and gynecology, Department of Obstetrics and gynecology, Faculty of Medicine, Qazvin University of Medical Sciences, Qazvin, Iran.² Faculty of Medicine, Qazvin University of Medical Sciences, Qazvin, Iran.³ General Medicine, Women's Reproductive Health Research Center, Faculty of Medicine, Tabriz University of medical sciences, Tabriz, Iran.
Mashrabi1383@yahoo.com

Abstract: Assessment of the efficacy of using intraumbilical vein (IUV) injection of Oxytocin in active management of the third stage of labor and reducing blood loss and length of the third stage. In a randomized double-blind clinical trial, 200 women undergoing vaginal delivery without any risk factor for postpartum hemorrhage recruited. 100 assigned to receive 10 international units (IU) oxytocin diluted in 9cc ringer by IUV injection and 10cc ringer by peripheral vein injection and 100 assigned to receive 10cc ringer by IUV injection and 10 international units (IU) oxytocin diluted in 9cc ringer by peripheral vein injection. Active management of labor (prophylactic injection of 20IU oxytocin after clamping of umbilical cord and controlled cord traction) was used in both groups. Pre delivery and post delivery hemoglobin level was assessed. The primary outcome was change in hemoglobin levels and duration of the third stage of labor. The third stage of labor was significantly shorter in IUV injection group (4.2 ± 4.1 minutes compared with 5.5 ± 4.5 minutes, respectively; $p=0.03$). An additional uterotonic agent in case group was needed less than the controlled group ($P=0.03$). Mean drop in hemoglobin levels in intervention group was 1.5 ± 0.96 (95% CI 1.16-1.53) and in control group was 1.35 ± 0.94 (95% CI 1.3-1.7) and there was significantly difference in this respect in two groups (p -value = 0.228). IUV injection of Oxytocin with the active management of the third stage of labor significantly reduced the rate of additional uterotonic agents and duration of third stage of labor. The hemoglobin reduce in the intervention group was lower compared to the control group but this difference was not analytically meaningful. Need to manual removal of the placenta, Hb levels after 24 hours after delivery, and placenta emersion time more than 15 minutes was lower in the group receiving oxytocin but the difference was not significant.

[Farideh Movahed, Reyhaneh Ramazan Nejhadi, Ezzatalsadat Haji Seid Javadi, Amir Javadi, Fatemeh Lalooha, Omid Mashrabi. **Efficacy of intraumbilical vein (IUV) injection of oxytocin in active management of the third stage of labor.** *Life Sci J* 2012;9(4):1242-1246] (ISSN:1097-8135). <http://www.lifesciencesite.com>. 186

Keywords: Third Stage of Labor; Oxytocin; Intraumbilical Vein Injection

1. Introduction

Postpartum hemorrhage as a major cause of maternal death worldwide, and is the cause of approximately half of all maternal deaths in developing countries (Belghiti, 2011) and even in many developed countries, the postpartum hemorrhage is one of the major causes of admission of mothers to intensive care units (Mercier and Van de Velde, 2008). In countries with poor health services, the impact of bleeding in maternal mortality is also higher than this statistics.

The Delivery hemorrhage is the cause of 12% of all maternal mortalities (Rossi and Mullin, 2012) and occurs in its highest rate after delivery. The common causes of postpartum hemorrhage, includes bleeding from the site of implantation of the placenta, genital and nearby organs trauma or both of them (Cunningham, 2010).

Hemostasis of Placental implantation site is first established with the contraction of myometrium

and thrombosis of the vessel lumens. As a result, parts attached to the placenta or large blood clots which impede efficient contracting of Myometrium, can disrupt hemostasis in the placental implantation site (Cunningham, 2010).

In the third stage of labor due to a partial and transient placental detachment, some degree of bleeding is unavoidable and sometimes the placenta can not be separated the uterus.

Prescribing oxytocin before the passing of placenta reduces the amount of bleeding (Cunningham, 2010). If there is a massive bleeding and placenta can not pass automatically, manually removing of the placenta should be carried out and stunning or anesthesia is required and aseptic surgical techniques must be used (Cunningham, 2010).

By Using of Oxytocin as injection into the umbilical vein, high concentrations of oxytocin reaches the placenta and causes the contraction of

uterus ,faster separation of placenta and reducing the time of the third stage of the labor(Harara, 2011).

This method has been used in most studies in the case of residual placentas (Retained Placenta) which has also been beneficial. (Güngördük, 2010).

With regard to the high prevalence of the iron deficiency anemia in our country finding a way to reduce the postpartum bleeding is necessary in the past studies it has been proven that oxytocin injection to the umbilical vein reduces the labor bleeding and prevent the hemoglobin decrease after the delivery and the aim of this study is to evaluate the effect of the oxytocin injection to the umbilical vein in management of the 3rd stage of the delivery and reducing the blood loss during this stage of the delivery.

2. Material and Methods

In a double blind randomized clinical trial in Ghazvin Kowsar hospital of the Qazvin medical university in 2011 we studied the effect of the oxytocin injection to the umbilical vein in management of the 3rd stage of the delivery and reducing the blood loss during this stage of the delivery in the term pregnant women.

We selected 200 pregnant women randomly amongst pregnant women attending to the gynecology ward of Qazvin Kowsar hospital and enrolled them to the study, then we divided the m randomly in to two equal groups .the patients was blind to the drug which used for them. Blood sample for checking the baseline hemoglobin was taken in the first stage.

After the second stage of the delivery we injected 20 units of oxytocin solution in 1 liter of ringer serum with rate of 10 cc per minute intravenously.

The intervention group received 10 IU oxytocin diluted in 10 ml Ringer's serum for 2 min in the umbilical vein proximal to the site of umbilical cord clamping and 10 cc of Ringer's serum as a placebo in a peripheral vein is injected from angiocath.

The control group received 10 units of oxytocin diluted in 10 ml Ringer's serum in a peripheral vein over 2 min and 10 ml of Ringer's serum as placebo in in the umbilical vein proximal to the site of umbilical cord clamping.

If the placenta delivery takes more than 30 minutes or if there is severe bleeding the placenta was removed manually.

In addition, if a patient was suffering from uterine atony, the additional uterotonic drugs were used .these cases is recorded in our study.

If the patient's postpartum hemoglobin decline was sharper or had symptoms of acute anemia, transfusion was performed for the patient.

All patients were monitored for up to one hour after delivery and their vital signs were monitored every 15 minutes. Patients were examined for Oxytocin complications including hypotension and cardiac arrhythmia, bleeding and uterine atony.

Inclusion Criterias:

37 to 42 weeks gestational age, singleton pregnancy, alive fetus with cephalic presentation, 2500 to 4500 gr birth weight, parity 1 to 3, normal vaginal delivery.

Exclusion criteria:

Blood pressure equal to or greater than 140/90, placenta previa, placental abruption, a history of bleeding after delivery in previous pregnancies, history of curettage or cesarean delivery or uterine scar, polyhydramnios, known uterine anomalies, abnormal placental adhesion, coagulation disorders, forceps or vacuum delivery, extensive episiotomy or vaginal and cervical tears that require extensive repairs in the operating room.

We also compared the two groups for During the third stage of labor, percentage of residual placenta after 15 minutes, hemoglobin decrease 24 hours after delivery, the need to manual or instrumental removal of the placenta, the need for transfusion, medical complications and the need to obtain additional uterotonic drugs.

Ethical considerations:

A drug used in this study, oxytocin which used in this study is routinely given to all patients after delivery and there is no complications recorded of its injection till now in the umbilical cord. All injections were through the primary angiocath site. At the beginning of study written consent is obtained from all patients who are enrolled into the study.

Problems and limitations:

The best time for hemoglobin check for patients is 48 to 72 hrs after the delivery and since we could not admit the patients for 2 or 3 days all hemoglobin checks was in 24 hrs after the delivery

The obtained data was coded and then entered into a computer and statistically analyzed by SPSS software. T-Test and chi-square test were used for data analysis. Significance level for tests was determined as 95% (P< 0.05).

3. Results

In this clinical trial, one patient in the third stage of labor in addition to 20 units of oxytocin injection of Ringer's serum, 10 units of oxytocin was injected into a peripheral vein and diluted to 100

patients and another 20 units oxytocin in Ringer's injection of serum, 10 units of oxytocin diluted was injected into the cord.

We also compared the two groups for During the third stage of labor, percentage of residual placenta after 15 minutes, hemoglobin decrease 24 hours after delivery, the need to manual or instrumental removal of the placenta, the need for transfusion, medical complications and the need to obtain additional uterotonic drugs.

Mean age, gestational age, parity, gravidity, first Hemoglobin, the frequency of induction and episiotomy and birth weight in the two groups are shown in Table 1.

Odds ratio of induction compared with control group (95% CI 0.4-1.45) was 1.3, which means the intervention group was under induction 1.3 times more than 1 control groups were equal (Table 1 and Figure 1).

Table 1. Evaluation of parameter between two groups

	Group		P
	Case	Control	
Age	25.28 ± 5.30	25.35 ± 5.57	0.890
Parity	0	46	0.632
	1	31	
	2	23	
Gravidity	1	46	0.732
	2	31	
	3	27	
Gestational age	39.1 ± 1.1	39 ± 1.1	0.455
Infant weight	3303.8 ± 366.3	3288 ± 435.7	0.782
Primary Mother Hb	12.8±0.98	12.6±1.17	0.269
Induction	23%	28%	0.517
Episiotomy	66%	58%	0.244

Table 2. Finding between two groups after intervention

	Group		P
	Case	Control	
Manual separation of the placenta	2(2%)	5(5%)	0.445
Need for transfusion	0	1(1%)	1
Need to additional uterotonic drugs	2(2%)	10(10%)	0.033
Third stage labor time	4.2±4.11	5.53±4.52	0.031
Hemoglobin drop	-	-1.5±0.96	0.228
placenta emersion time more than 15 minutes	2(2%)	5(5%)	0.445
Drug complication	0	0	-
Hemoglobin 24 hour after labor	11.5±1.2	11.1±1.3	0.065

There were no statistically significant difference in the findings of the two study groups regarding gestational age, parity, gravidity, birth weight, induction and episiotomy rates found no statistically significant difference (p> 0.05) and both groups to review in the study were matched.

Mean delivery time in the control group 4.11 ± 4.2 min (95% CI 3.38-5.02) and 4.52 ± 5.53 minutes in the control group (95% CI 4.63-6.42) which was significantly lower in the intervention group (P=0.031).

In 2% of patients in the intervention group and 5% of control the placental enersion takes more than 15 minutes (p-value = 0.445) (Table 2).

The mean hemoglobin 24 hours after delivery in intervention group was 11.5 ± 1.2 (95% CI 11.2-11.7) and in the control group was 11.17 ± 1.3 (95% CI 10.9-11.4) (p = 0.065) (Table 2 and Figure 2).

Mean drop in hemoglobin levels in intervention group was 1/5±0/96 (95% CI 1.16-1.53) and in control group was 1/35±0/94 (95% CI 1.3-1.7) and there was significantly difference in this respect in two groups (p-value = 0.228) (Table 2).

In 2% of control group and 10 % of intervention group there was a need for using the uterogenic agents that this number patient group was significantly lower in intervention group than control group(p = 0.033) (Table 2).

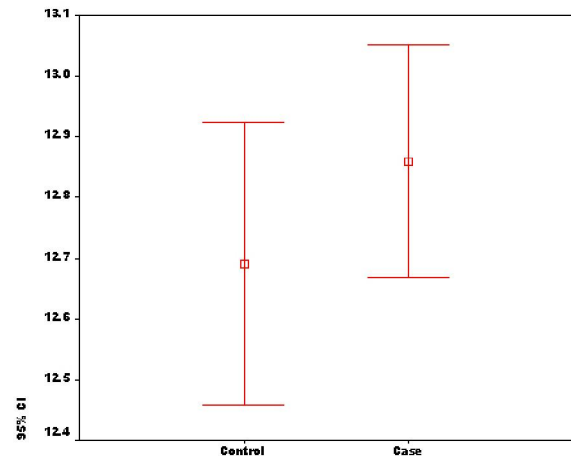
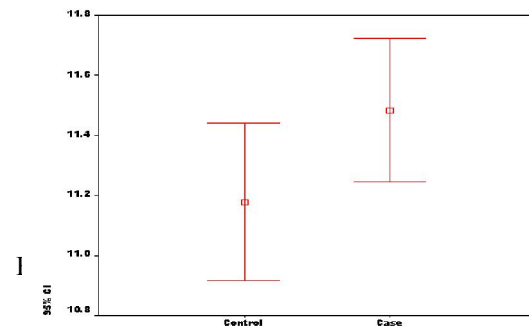

Figure 1. Distribution of patient's hemoglobin before labor



4. Discussion

Oxytocin's role in accelerating the third stage of labor and its effect on the placenta and reduce bleeding after delivery is clear. Intravenous and intramuscular use of Uterogenic agents and oxytocin is approved in references.

This study was based upon the hypothesis that injection of oxytocin in the umbilical cord vein can reduce the third stage of delivery and the amount of the bleeding after the delivery

From 1980s, few studies have been performed in this subject these studies have evaluated the uterotonic agents injection in the umbilical cord and they have concluded that "the drug can pass through the placenta and umbilical vein and reach uterine artery. Most of these studies have been cases where the placenta could not separate spontaneously and manual separation of the placenta was done (Belghiti, 2011).

In our study, injection of oxytocin into the umbilical vein compared with peripheral intravenous injection and its results in the third stage of labor. The aim of this study was to compare the drug injection to umbilical cord with its injection to umbilical vein.

In past studies, the drug is injected only in the cord and its effect was compared with placebo (Güngördük, 2010).

If we assume that even a small percentage of the drug can reach the placenta from the cord, in any case much more uterotonic drugs is received by the intervention group to improve the results.

Approximately all patients admitted for delivery has an intravenously open way to receive the drug, whether is it necessary to examine the effect of injection on the cord? In urgent situations where delivery is made and there is not an intravenous way to inject the drugs can we use umbilical cord vein as a way to access the placenta and injection of uterotonic agents to prevent uterine atony, bleeding and residual placenta.

In our study, there was no statistically significant difference between two groups regarding gestational age, number of pregnancies, number of previous birth weight infants, episiotomy performed and results were similar for both groups.

In our study and in the intervention group the time of the third stage of the delivery was 4.2 ± 4.11 and in control group was 5.53 ± 4.52 minutes which was meaningfully lower in intervention group, as a result the oxytocin injection to the umbilical cord can increase the speed of placental emersion This result probably reflects the higher speed access to the uterine oxytocin in the intervention group.

In a study by Reddy and et al study, the third stage time of the delivery was 4.1 minutes in the

group with oxytocin injection to the umbilical vein and 9.4 minutes in the group with injection of normal saline in umbilical vein (Reddy and Carey, 1989).

Weeks and colleagues injected 50 units of oxytocin in the umbilical vein which this injection precipitate the placental separation (Weeks, 2010). Gungorduk and et al. conducted a study in 2010 in Turkey, with the aim of evaluating effect of injecting the oxytocin in the umbilical cord and stated that the duration of stage 3 in the group receiving oxytocin into the umbilical vein was 4.5 ± 1.6 minutes and in placebo group, 9.7 ± 4.3 minutes which was significantly lower in the intervention group ($P < 0.001$). (Güngördük, 2010).

In our study, approving the above results the third stage of labor in the intervention group was significantly lower than control indicating greater impact of umbilical vein injection of oxytocin in the third stage of labor is accelerating.

In our study the need to use additional uterotonic agents was 2% in intervention group 10% in control group which was significantly lower in in the intervention group as a result the injection of oxytocin in umbilical vein in the third stage of delivery reduces the uterine atony, need for using the additional uterotonic drugs to prevent the bleeding.

In the study of Gungorduk and colleagues the need for uterotonic agents in the oxytocin receiving group was 1 person(0/5%) and in the placebo group was 7 persons(3.4%) that was significantly lower in the oxytocin group ($p=0.03$) (Güngördük, 2010).

Reddy and colleagues stated 373 cc blood loss in the intervention group 135 cc in control group (8).

In the study of Gungorduk and colleagues the amount of bleeding in the administration of oxytocin group was 195.3 ± 81 cc and in placebo group, 288.3 ± 134 cc, which was significantly lower in the group receiving oxytocin. ($P < 0.001$) (Güngördük, 2010).

In the study conducted by Gungorduk and colleagues (Güngördük, 2010) the oxytocin injection to umbilical vein has been compared with the placebo injection to the umbilical cord but we compared oxytocin injection to umbilical cord with the injection of oxytocin to a peripheral vein to determine if reaching to the placenta in peripheral vein is faster or by the umbilical vein.

In our study the prescription of oxytocin was equal for both groups and the difference was only in the route of administration but the in the Gungorduk et al study (Güngördük, 2010), the intervention group received oxytocin while the control group did not receive oxytocin. We can conclude that in their study the intervention group receives more uterotonic

agents than the control group and the uterine also receive more uterotonic agents and this improves the results in the point of bleeding and the hemoglobin loss.

We also should consider the laboratory faults in the measurement of the Hb and its better to use a method with the fewest faults after the delivery. Our study reveals that oxytocin injection to umbilical cord has no advantages to its injection to the peripheral vein in reducing bleeding the third stage of the labor.

The need to manual removal of the placenta in our study and in the control group was in 5 patients (but there were not significant difference between the two groups ($p=0.445$))

The rate of placenta remaining in the study by Gungorduk after 15 minutes and the need for curettage was 1 person in placebo group and there were not case like that in the oxytocin receiving group that the difference was not meaningful between the two groups ($p=0.49$).

In our study there was only one case who needed the transfusion in the control group and there were not significantly difference between two groups ($p=1$).

In the study by Gungorduk and colleagues there also was just 1 case of transfusion requirement in the placebo group and two groups was not different analytically ($p=0.49$) (Güngördük, 2010).

Conclusion

With regards to the findings of this study we can conclude that the oxytocin injection to the umbilical cord comparing with its injection to a peripheral vein has no advantages in reducing the postpartum hemorrhage whereas it can reduce the need for the use of other uterotonic agents and the time of the 3rd stage of delivery. The hemoglobin reduce in the intervention group was lower compared to the control group but this difference was not analytically meaningful.

Need to manual removal of the placenta, Hb levels after 24 hours after delivery, and placenta emersion time more than 15 minutes was lower in the group receiving oxytocin but the difference was not significant.

Recommendations

With regards to the findings of this study we can conclude that the oxytocin injection to the umbilical cord comparing with its injection to a peripheral vein has no advantages in reducing the postpartum hemorrhage whereas it can reduce the need for the use of other uterotonic agents and the time of the 3rd stage of delivery and these findings shows the advantages of this methods. So performing other similar studies with the population more than this study to evaluate the volume of the hemorrhage

in the oxytocin receiving group and in the control group to eliminate the Hb measurement faults is recommended.

In addition if the results of oxytocin injection to the umbilical cord can be comparable with its injection to a peripheral vein and in the cases which there is need for injecting the uterotonic agents and the peripheral vein is not available the umbilical cord can be used for injection and preventing the delivery hemorrhage and to facilitate the placental removal.

Corresponding Author:

Dr. Ezzatalsadat Haji Seid Javadi

Department of Obstetrics and gynecology, Qazvin University of Medical Sciences, Qazvin, Iran.

E-mail: mashrabi1383@yahoo.com

References

- 1- Belghiti J, Kayem G, Dupont C, Rudigoz RC, Bouvier-Colle MH, Deneux-Tharaux C. Oxytocin during labour and risk of severe postpartum haemorrhage: a population-based, cohort-nested case-control study. *BMJ Open* 2011; 1(2):e000514.
- 2-Mercier FJ, Van de Velde M. Major obstetric hemorrhage. *Anesthesiol Clin* 2008; 26(1):53-66.
- 3-Rossi CA, Mullin P. The etiology of maternal mortality in developed countries: a systematic review of literature. *Arch Gynecol Obstet* 2012; 285(6):1499-503.
- 4- Cunningham G, Leveno KJ, Bloom SL, Hauth JC, Gilstrap LC, Wenstrom KD. *William's Obstetrics*, 23rd ed. McGraw-Hill Professional, Philadelphia, 2010; 310-35.
- 5-Harara R, Hanafy S, Zidan MS, Alberry M. Intraumbilical injection of three different uterotonics in the management of retained placenta. *J Obstet Gynaecol Res* 2011; 37(9):1203-7.
- 6-Güngördük K, Ascioglu O, Besimoglu B, Güngördük OC, Yildirm G, Ark C, Tekirdağ AI. Using intraumbilical vein injection of oxytocin in routine practice with active management of the third stage of labor: a randomized controlled trial. *Obstet Gynecol* 2010; 116(3):619-24.
- 7-Reddy VV, Carey JC. Effect of umbilical vein oxytocin on puerperal blood loss and length of the third stage of labor. *Am J Obstet Gynecol* 1989; 160(1):206-8.
- 8-Weeks AD, Alia G, Vernon G, Namayanja A, Gosakan R, Majeed T, et al. Umbilical vein oxytocin for the treatment of retained placenta (Release Study): a double-blind, randomised controlled trial. *Lancet* 2010; 375(9709):141-7.

10/2/2012

The relationship between the level of homocysteine in mother's serum and the intensity of preeclampsia

Ezzatalsadat Haji Seid Javadi¹, Fatemeh Ghorbali¹, Mohammadreza Sarookhani², Amir Javadi³, Omid Mashrabi⁴

1. Assistan professor of Obstetrics and gynecology, Department of Obstetrics and gynecology, Faculty of Medicine, Qazvin University of Medical Sciences, Qazvin, Iran.
2. Associated professor of biotechnology, Clinical and molecular Research Center, Qazvin University of Medical Sciences, Qazvin, Iran.
3. Faculty of Medicine, Qazvin University of Medical Sciences, Qazvin, Iran.
4. General Medicine, Women's Reproductive Health Research Center, Faculty of Medicine, Tabriz University of medical sciences, Tabriz, Iran.
Mashrabi1383@yahoo.com

Abstract: Determining the relationship between maternal serum homocysteine level and severity of preeclampsia. In a cross-sectional descriptive-analytical study, maternal homocysteine level was assessed in patients with mild and severe preeclampsia. The mean level was assessed by electro-immunoassay enzyme test. No significant difference was observed in age, parity and abortion history among pregnant mothers. The mean serum homocysteine level was 5.5 ± 1.6 in control group, 6.3 ± 1.9 in mild preeclampsia and 8.9 ± 4.1 in severe preeclampsia. The mean serum homocysteine level was significantly higher in women with severe preeclampsia than in control group ($P < 0.001$), but no significant difference between normal pregnant women and those with mild preeclampsia ($P = 0.12$). This study revealed a direct relationship between concentration of serum homocysteine and severity of preeclampsia. However, in mild preeclampsia, the concentration of serum homocysteine slightly changes with no significant difference. It is deduced that low homocysteine concentration makes slight changes to vascular endothelium. [Ezzatalsadat Haji Seid Javadi, Fatemeh Ghorbali, Mohammadreza Sarookhani, Amir Javadi, Omid Mashrabi. **The relationship between the level of homocysteine in mother's serum and the intensity of preeclampsia.** *Life Sci J* 2012;9(4):1247-1249] (ISSN:1097-8135). <http://www.lifesciencesite.com>. 187

Keywords: Preeclampsia; Homocysteine; Intensity

1. Introduction

Preeclampsia is one of the most important factors for mortality during pregnancy. Etiology of preeclampsia is not yet clear, but what is certain is that a variety of disorders that lead to vascular spasm and endothelial dysfunction may play a crucial role in its occurrence (Cunningham, 2010). In its metabolism cycle, homocysteine is metabolized into cysteine or methionine, and these two need vitB2, vitB12, vitB6 and folic acid cofactors; hence, in cases of deficiency of the mentioned cofactors, hyperhomocysteinemia occurs (Cunningham, 2010).

Thickening the intima layer of arteries, Hyperhomocysteinemia reduces the elasticity of the lamina and hypertrophies the Smooth muscle tissue. Also, Thiolactone, metabolite of homocysteine, attaches to LDL of macrophages and produces atherosclerotic plaque in vascular intima layer (Tug, 2003). Hyperhomocysteinemia causes oxidative stress, increased level of lipid peroxides, increased activity of antioxidants and reduced level of nitric oxide, which can lead to dysfunction of endothelial cells (Urmila, 2009).

Homocysteine level in normal non-pregnant people is about $5-15 \mu\text{mol/L}$, while it decreases to 3.3 to $7.5 \mu\text{mol/L}$ during pregnancy (Cotter, 2001). This reduction may be the result of increased level of

estrogen, Hemodilation, or due to increased consumption of methionine by the mother and fetus (Hoque, 2008).

Given the above, the level of homocysteine is expected to be higher in patients with preeclampsia than normal pregnant subjects. The aim of this study is to determine the relationship between maternal serum homocysteine level and severity of preeclampsia.

2. Material and Methods

In a descriptive-analytical case-control study on 168 pregnant mothers referred to the Kawthar Hospital of Qazvin University of Medical Sciences, the relationship between maternal serum homocysteine level and severity of preeclampsia was investigated.

All patients were divided into three groups: The first group (the control group) consisting of 60 pregnant women without hypertension and with gestational age of 37 who were nominated for termination of pregnancy. The second group included 55 pregnant women with mild preeclampsia, and the third group included 53 pregnant women with severe preeclampsia.

Exclusion criteria: Occurrence of Chronic HTN (blood pressure greater than or equal to 90/140

prior to the 20th week of pregnancy or before pregnancy without symptoms of mild and severe preeclampsia), anemia (Hb < 11), chronic hepatic diseases, renal diseases, a history of repeated abortions (More than 2 abortions), placental abruption, smoking, diabetes, anti-folate drugs such as Methotrexate and anticonvulsants.

A 2cc blood sample was taken from all women under study after 8 hours of fasting and kept on EDTA anticoagulation. Immediately, the plasma was extracted and kept frozen till the test time. In this research, the homocysteine of blood was assessed using electroimmunoassay enzyme test (EIA) kit.

The obtained data was coded and then entered into a computer and statistically analyzed by SPSS software. ANOVA test was used for data analysis. Significance level for tests was determined as 95% (P< 0.05).

3. Results

The mean age was 26.5 ± 5.8 years in the control group, 28.8 ± 6.3 in mild preeclampsia group, and 27.7 ± 5.8 years in severe preeclampsia group that there was no significant difference in the mean age of the patients under study among the three groups (P=0.11).

The mean parity was 1.8 ± 0.9 in patients of the control group, 2.1 ± 1.5 in patients with mild preeclampsia, and 2.1 ± 1.4 in patients with severe preeclampsia that there was no significant difference in the mean parity of the patients under study among the three groups (P=0.4).

The mean serum homocysteine was 5.5 ± 1.6 μmol/L in the range of 3-10.3 μmol/L in control group patients, 6.3 ± 1.9 μmol/L in the range of 3-12.1 μmol/L in patients with mild preeclampsia, and 8.9 ± 4.1 μmol/L in the range of 5.3-27.8 μmol/L in patients with severe preeclampsia (Table 1).

Serum homocysteine level in patients with severe preeclampsia were significantly higher (P<0.001); but there was no significant difference in the mean serum homocysteine level between patients with mild preeclampsia and the control group patients (P=0.12) (Table 1).

Table 1. Age, parity and level of serum homocysteine between three groups of patients

	Control Group (n=60)	Groups		P_V
		Mild Preeclampsia (n=55)	Sever Preeclampsia (n=53)	
Age(year)	26.5 ± 5.8	28.8 ± 6.3	27.7 ± 5.8	0.11
Parity	1.8 ± 0.9	2.1 ± 1.5	2.1 ± 1.4	0.4
Homocysteine	5.5 ± 1.6	6.3 ± 1.9	8.9 ± 4.1	<0.001

4. Discussion

In this study, the mean maternal serum homocysteine in the third trimester of pregnancy in

pregnant mothers in the control group was 5.5 ± 1.6 μmol/L that had decreased compared to non-pregnant people.

Total maternal serum homocysteine level was increased in preeclamptic women and hyperhomocysteinemia was associated with severity of preeclampsia (Khosrowbeygi, 2011).

Bergen, in the study "Department of Clinical Chemistry, Department of Public Health, Erasmus University Medical Centre, Rotterdam, Netherlands" showed that high homocysteine and low folate concentration in early pregnancy may adversely influence placentation and subsequently, affect the success of pregnancy and birth outcomes (Bergen, 2012).

Mislanova and et al. suggested that disordered placental folate-related metabolism may be one of the pathogenetic factors in preeclampsia (Mislanova, 2011).

Different studies have confirmed that elevated tHcy is a risk factor for sub-fertility, congenital developmental defects, preeclampsia, and intrauterine growth retardation (Murphy, 2011).

In the study by Walker at 1999, the mean serum homocysteine in pregnant women with normal pregnancies in the third trimester was 5.5 μmol/L (Walker, 1999) that the same was in our study.

In our study, the mean serum homocysteine was 5.5 ± 1.6 μmol/L in the control group patients, 6.3 ± 1.9 μmol/L in patients with mild preeclampsia, and 8.9 ± 4.1 μmol/L in patients with severe preeclampsia.

As is known, vascular spasm, endothelial destruction and dysfunction plays a vital role in occurrence of preeclampsia and hyperhomocysteinemia is one of the factors causing oxidative stress and endothelial cell dysfunction. In many studies, increased homocysteine level in preeclampsia has been proven, but fewer studies have proceeded to compare the homocysteine level in mild and severe preeclampsia.

In the study by Urmila and et al. in India (Urmila, 2009), and the study by İncec and et al. in the Ataturk University School of Medicine, Izmir, Turkey (İncec, 2005), they showed that there was no significant difference in homocysteine level between pregnant women with normal blood pressure and those with mild preeclampsia, but there was a significant difference between pregnant women with severe preeclampsia and those with normal blood pressure.

In the study by Dudani and et al, there was a significant difference in homocysteine level between hypertensive pregnant women and those with mild preeclampsia (Dudani, 2006) which is inconsistent with our study.

Acilmis and et al. showed that maternal and fetal serum homocysteine levels were found to be significantly higher in severe preeclampsia group than in mild preeclampsia and control groups, suggesting that elevated level of serum homocysteine might be associated with severity of preeclampsia (Acilmis, 2011).

As can be observed, in all studies, there is a direct relationship between homocysteine level and severe preeclampsia.

In different studies, contradictory results have been obtained about the significant increase in homocysteine in mild preeclampsia. It may be concluded from the above discussions that low concentration of homocysteine slightly affects the endothelium and has a subtle role in occurrence of preeclampsia. More prospective studies are needed to clarify this issue. This important goal may be achieved by measuring serum homocysteine during the first trimester of pregnancy and follow up of patients in terms of affliction by preeclampsia.

Conclusion

This study revealed a direct relationship between serum homocysteine concentrations with severe preeclampsia. However, in mild preeclampsia the concentration of serum homocysteine changes trivially and there is no significant difference. It can be deduced that the low concentration of homocysteine makes trivial changes in vascular endothelium.

Corresponding Author:

Dr. Ezzatalsadat Haji Seid Javadi
Department of Obstetrics and gynecology, Qazvin
University of Medical Sciences, Qazvin, Iran.
E-mail: mashrabi1383@yahoo.com

References

- 1-Cunningham FG, Leveno KJ, Bloom SL, Hauth JC, Gilstrap LC, Wenstrom KD. Williams Obstetrics, 23rd ed. McGraw-Hill Professional, New York, 2010; 706-49.
- 2-Tug N, Celik H, Cikim G, Ozcelik O, Ayar A. The correlation between plasma homocysteine and malondialdehyde levels in preeclampsia. *Neuro Endocrinol Lett* 2003; 24(6):445-8.
- 3-Urmila S, HP Gupta, PK Singh. Homocysteine: Association with preeclampsia and normotensive pregnancy. *J obstet Gynecol India* 2009; 59(3):235-8
- 4-Hoque MM, Bulbul T, Mahal M, Islam NA, Ferdousi M. Serum homocysteine in pre-eclampsia and eclampsia. *Bangladesh Med Res Counc Bull* 2008; 34(1):16-20.

- 5- Cotter AM, Molloy AM, Scott JM, Daly SF. Elevated plasma homocysteine in early pregnancy: a risk factor for the development of severe preeclampsia. *Am J Obstet Gynecol* 2001; 185(4):781-5.
- 6-Khosrowbeygi A, Ahmadvand H. Circulating levels of homocysteine in preeclamptic women. *Bangladesh Med Res Counc Bull* 2011; 37(3):106-9.
- 7-Bergen N, Jaddoe V, Timmermans S, Hofman A, Lindemans J, Russcher H, Raat H, Steegers-Theunissen R, Steegers E. Homocysteine and folate concentrations in early pregnancy and the risk of adverse pregnancy outcomes: the Generation R Study. *BJOG* 2012; 119(6):739-51.
- 8-Mislanova C, Martsenyuk O, Huppertz B, Obolenskaya M. Placental markers of folate-related metabolism in preeclampsia. *Reproduction* 2011; 142(3):467-76.
- 9-Murphy MM, Fernandez-Ballart JD. Homocysteine in pregnancy. *Adv Clin Chem* 2011; 53:105-37.
- 10-Walker MC, Smith GN, Perkins SL, Keely EJ, Garner PR. Changes in homocysteine levels during normal pregnancy. *Am J Obstet Gynecol* 1999; 180(3 Pt 1):660-4.
- 11-Ingec M, Borekci B, Kadanali S. Elevated plasma homocysteine concentrations in severe preeclampsia and eclampsia. *Tohoku J Exp Med* 2005; 206(3):225-31.
- 12-Dudani AL, Khoja A, Karira KA. Assessment of Homocysteine levels preeclampsia. *Med Chanel* 2006; 12(2):16-8.
- 13-Acilmis YG, Dikensoy E, Kutlar AI, Balat O, Cebesoy FB, Ozturk E, et al. Homocysteine, folic acid and vitamin B12 levels in maternal and umbilical cord plasma and homocysteine levels in placenta in pregnant women with pre-eclampsia. *J Obstet Gynaecol Res* 2011; 37(1):45-50.

9/25/2012

Study on serum Copper and Zinc level of children with epilepsy during long term therapy with anticonvulsants

Lida Saboktakin¹, Mohammad Barzegar¹, Amir Ghorbani Hagh Jo², Mohammad Emamalizadeh³

¹. Pediatric Health Research Center, Department of Pediatric, Tabriz University of Medical Sciences, Tabriz, Iran.

². PhD of Biochemistry, Biotechnology Research Center, Tabriz University of Medical Sciences, Tabriz, Iran.

³. Faculty of Medicine, Tabriz University of medical sciences, Tabriz, Iran.

Lidasaboktakin@yahoo.com

Abstract: Epilepsy is a disorder of brain electrical activity that may lead to recurrent seizures. Changes in serum levels of some trace elements such as Zinc and Copper can be observed in patients with Epilepsy. The aim of this study was evaluating the serum levels of copper and zinc in patients with epilepsy on long term treatment of anticonvulsant agents in Tabriz children's hospital. In a case control descriptive –analytical study in the children's diseases department of Tabriz children's hospital we evaluated the serum levels of copper and zinc in patients with epilepsy and compared them with healthy subjects. The two groups were matched for age, gender, weight and height. The mean zinc level in children with epilepsy is 0.30 ± 0.13 and 0.93 ± 0.25 $\mu\text{g/ml}$ respectively which was lower meaningfully in epileptic patients. The copper level in patients with epilepsy was 1.06 ± 0.36 $\mu\text{g/ml}$ and in control group was 0.39 ± 0.21 $\mu\text{g/ml}$ respectively which was significantly higher in the case group. Serum copper levels in epileptic children under drug treatment are higher than in healthy children. Also, serum zinc levels in these patients are significantly lower than in healthy people. The use of one drug or multiple drugs in the treatment of epileptic patients have made a significant difference in the levels of serum copper and zinc and also the serum level of Zinc in patient under treatment with Phenobarbital, Phenytoin, Carbamazepine, Valproate sodium, Clonazepam, Topiramate and Primidone was significantly lower and the serum level of Copper in patients winder treatment by Phenobarbital, Phenytoin, Carbamazepine and Valproate sodium was significantly higher.

[Lida Saboktakin, Mohammad Barzegar, Amir Ghorbani Hagh Jo, Mohammad Emamalizadeh. **Study on serum Copper and Zinc level of children with epilepsy during long term therapy with anticonvulsants.** *Life Sci J* 2012;9(4):1250-1254] (ISSN:1097-8135). <http://www.lifesciencesite.com>. 188

Keywords: Epilepsy; Zinc; Copper

1. Introduction

Epilepsy is a disorder of brain electrical activity that may lead to recurrent seizures. Type of seizure depends on the part of the brain involved and various causes can lead to the seizure. The absence of a specific cause for the seizures Epilepsy is called primary or idiopathic (Gaby, 2007).

The exact mechanism of epilepsy is largely unknown. The routine treatment of the epilepsy is the using of the anticonvulsants agents. The use of such drugs mainly controls the disease or can reduce the times of the seizure, but in some patients, treatment is not effective or patient suffers repeated seizures. Recent researches have shown that a specific diet, micronutrients, and hormones are useful in the treatment of patients with Epilepsy (Sołowiej and Sobaniec, 2003). With regard to the fact that the Zinc is a regulator of the glutamic acid decarboxylase enzyme that has a major role in the production of the gamma amino butyric acid-an inhibitory neurotransmitter- and the deficiency of this enzyme can lead to epileptic disorders. Changes in serum levels of some trace elements such as copper can be

observed in patients with Epilepsy. Besides these micronutrients to prevent or overcome the effects of certain deficiencies in the use of anticonvulsant drugs are effective (Tutor-Crespo, 2003).

Barbeaus and colleagues examined the changes in serum levels of Zinc in patients with Epilepsy and stated that serum levels of zinc is low in these patients (Barbeau and Donaldson, 1974). Schott and colleagues showed that patients with epilepsy have a normal level of zinc and an elevated level of copper (Schott and Delves, 1978). Plum and colleagues in a study on patients with Epilepsy concluded that increased serum levels of copper in these patients (Plum and Hansen, 1960).

In a study by the Tutor and his colleagues on 49 patients with generalized and partial Epilepsy serum copper and zinc were compared to control subjects, it showed no difference in plasma levels of copper and zinc in these patients (Tutor-Crespo, 2004).

Sherifa and colleagues in a study on 70 patients with epilepsy and 40 healthy children as controls Epilepsy showed that serum levels of Zinc

in patients on treatment (particularly with sodium valproate) is high whereas Copper levels in these patients are low (Sherifa, 2004)

With considering the fact that epilepsy and its frequent attacks have psychological and financial burden in the family and with regard to the previous studies result which has reported a variable results in the serum copper and zinc levels in these patients we designed a study to evaluate the serum levels of copper and zinc in patients with epilepsy on long term treatment of anticonvulsant agents in Tabriz children's hospital.

2. Material and Methods

In a case control descriptive –analytical study in the children's diseases department of Tabriz children's hospital we evaluated the serum levels of copper and zinc in patients with epilepsy and compared them with healthy subjects.

In this study, all children and adolescents with Epilepsy in 2010 during a visit to Children's Hospital and neurology clinic were enrolled in the study.

Inclusion criteria included age under 18 years, over one year duration of epilepsy, the top 25 percentile in weight not using compounds containing copper and zinc in the past 6 months, not receiving other drugs but anticonvulsant drugs, no obvious intracranial pathology, absence of disease leading to recent surgery, Absence of seizures in at least 24 hours before sampling, normal liver tests and renal tests, and other diseases were not.

The control group has been selected from children attending in Children's hospital general clinics to periodically controlling of the growth who had no known diseases.

The control group was matched with the case group for age, gender, height and weight and had not used copper and zinc containing compounds in the past 6 months. For exact measurement of height and weight in children we used SECA weight and height meter.

After overnight fasting venous blood samples was taken from the patient .the sample was centrifuged and serum was isolated in the laboratory and in Eppendorf tubes transported to the biochemistry laboratory of applied drug research center in -70° to measurement of serum levels of copper and zinc with atomic absorption spectrophotometry method.

The serum Copper(sensitivity: 0.03 mg/l, detection Limit: 0.004 mg/l, Working Range: 0.018-40. mg/l) and Zinc(sensitivity: 0.01 mg/l, detection Limit: 0.003 mg/l, Working Range: 0.01-30. mg/l) concentrations was determined by Atomic absorption methods, using CTA 3000 Atomic Absorption

Spectrometer(ChemTech Analytical Instruments Limited, UK) equipped with Air/acetylene flame.

In order to eliminate confounding variables, tests of liver and kidney were noted. The National Center for Health Statistics (NCHS) standard curve was used to convert weight and height to the standard Deviation Score (SDS).

Statistical analysis:

All data were analyzed using descriptive and deductive statistics methods by SPSS Ver. 15. The relation between qualitative data was evaluated using Chi-square test. And the relation between quality and quantity data were evaluated using T-test, ANOVA tests and the relation between the variables were evaluated using Pearson and Spearman correlation coefficient. $P < 0.05$ was considered meaningful.

3. Results

We studied the serum levels of copper and zinc in 50 epileptic patients with 50 healthy patients as control group. The two groups were matched for age, gender, weight and height. The demographic findings of both groups are shown in the table 1.

The mean zinc level in children with epilepsy is 0.30 ± 0.13 and 0.93 ± 0.25 $\mu\text{g/ml}$ respectively which was lower meaningfully in epileptic patients (figure 1). The copper level in patients with epilepsy was 1.06 ± 0.36 $\mu\text{g/ml}$ and in control group was 0.39 ± 0.21 $\mu\text{g/ml}$ respectively which was significantly higher in the case group (figure 2). Laboratory parameters of both study groups are shown in table 2.

The family history of epilepsy and febrile convulsion were positive in 9% and 2% of epileptic patients, respectively that positive family history of epilepsy was significantly more in case group.

Type of seizure and treatment and Response to treatment in patients with epilepsy upon gender is shown in table 3.

Laboratory findings between two groups based on Type of seizure and treatment and Response to treatment were shown in table 4.

The serum copper levels in patients with epilepsy had no linear correlation with laboratory parameters of study whereas the zinc levels of this group had a straight linear correlation with height percentile of patients($R=0.411, P=0.003$) and an inverse linear correlation with the age of onset of epilepsy($R=-0.279, P=0.045$).

The serum level of Zinc and Copper of patients with epilepsy according to the type of medication used are shown in table 5 indicating the serum level of Zinc in patient under treatment with Phenobarbital, Phenytoin, Carbamazepine, Valproate sodium, Clonazepam, Topiramate and Primidone was

significantly lower and the serum level of Copper in patients under treatment by Phenobarbital, Phenytoin, Carbamazepine and Valproate sodium was significantly higher.

Onset of Epilepsy and treatment, Seizure count per month, Number of Drugs and Duration of treatment based on Type of seizure and treatment and Response to treatment were shown in table 6.

Table 1. Demographics parameter of patients between two groups

	Gender	Group		P
		Case	Control	
	Male	32	32	
	Female	18	18	1
Age		61.72 ± 39.99	61.52 ± 43.86	0.981
Height		107.55 ± 20.41	109.56 ± 21.88	0.636
Height Percentile-for-age		45.32 ± 21.82	53.90 ± 25.62	0.075
Weight		19.85 ± 9.16	21.48 ± 11.49	0.434
Weight Percentile-for-age		61.60 ± 20.51	63.15 ± 20.64	0.708

Table 2. Laboratory findings between two groups

	Group		P
	Case	Control	
Copper	1.06 ± 0.36	0.39 ± 0.21	<0.001
Zinc	0.30 ± 0.13	0.93 ± 0.25	<0.001
Ceruloplasmin	0.37 ± 0.09	0.37 ± 0.09	0.699
SGOT [†]	29.52 ± 6.43	26.96 ± 6.76	0.055
SGPT [‡]	11.44 ± 4.45	10.06 ± 3.34	0.083
Alkaline Phosphatase	446.38 ± 164.90	474.31 ± 162.28	0.395
GGT [€]	10.94 ± 4.63	9.48 ± 3.18	0.069
Total Protein	7.39 ± .66	7.57 ± .46	0.130
Albumin	4.31 ± .36	4.44 ± .41	0.123
Urea	23.22 ± 5.74	24.36 ± 5.59	0.321
Creatinine	0.55 ± 0.12	0.54 ± 0.14	0.770

* _ Serum Glutamine Oxaloacetate Transaminase

‡ _ Serum Glutamine Pyruvate Transaminase

€ _ Gamma-glutamyl Transpeptidase

Table 3. Type of seizure and treatment and Response to treatment based on gender

	Gender	Gender		P
		Male	Female	
Type of seizure	Generalized	28	16	0.631
	Partial	4	2	
	Non	10	8	
Type of response to treatment	responder	17	8	0.638
	Moderate responder	5	2	
	Complete responder	12	6	
Type of treatment	Single drug	12	6	0.768
	Multiple drugs	20	12	

4. Discussions

Epilepsy is an important disease with an incidence rate of 0.5% rising up to 3% in case of a history of one time convulsion, including a wide range of symptoms and etiologies (Barbeau and Donaldson, 1974). Despite their low amount,

micronutrients play an important role in metabolic processes and are effective in the development of central and peripheral nervous system. Deficiency of these micronutrients can lead to various health problems in central and peripheral nervous system (Motta, 1998).

Different mineral elements are critical for normal functioning of the central nervous system and several studies have demonstrated that changes in different electrolytes of the body such as sodium, potassium, magnesium, and the trace elements such as copper and zinc are effective on incidence of convulsions and subsequently, epilepsy (Liu, 1998).

Free radicals and decreased antioxidant activity may be effective in increasing incidence risk of convulsions and their recurrence; and micronutrients (copper, zinc and magnesium) may prevent the incidence and progression of convulsions and subsequent epilepsy by increasing the antioxidant activity (Ilhan, 2004).

In our study, serum copper levels in epileptic patients undergoing treatment with anticonvulsant drugs were significantly higher than in control group; and in return, serum zinc levels in epileptic patients were significantly lower.

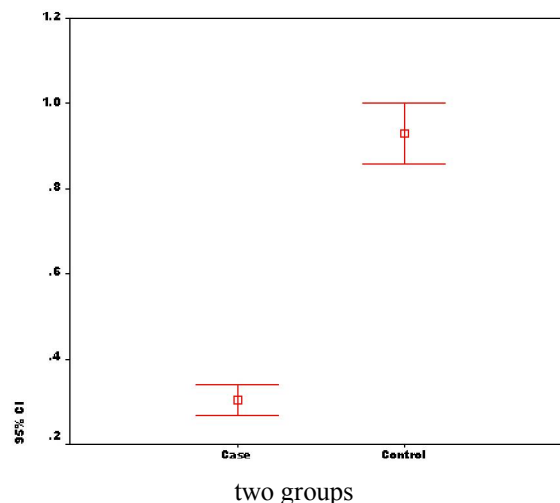

Motta et al demonstrated that prolonged use of anticonvulsant drugs decreases patients' serum copper levels, but has no effect on their serum zinc levels (Motta, 1998).

Evaluating copper and zinc levels in epileptic patients, Verrotti et al demonstrated that in the group treated with anticonvulsant drugs only the serum zinc level was significantly lower than in control group, but no significant difference in levels of other elements (copper and magnesium) (Verrotti, 2002).

In our study, the serum level of Zinc in patient under treatment with Phenobarbital,

Table 4. Laboratory findings between two groups based on Type of seizure and treatment and Response to treatment

	Type of seizure		P	Response to treatment			P	Type of treatment		P
	Generalized	Partial		Non responder	Moderate responder	Complete responder		Single drug	Multiple drugs	
Copper	1.08 ± 0.35	1.02 ± 0.46	0.720	1.15 ± 0.35	0.98 ± 0.38	1.08 ± 0.29	0.329	1.03 ± 0.31	1.09 ± 0.39	0.603
Zinc	0.29 ± 0.12	0.40 ± 0.09	0.038	0.32 ± 0.15	0.30 ± 0.12	0.26 ± 0.07	0.565	0.30 ± 0.12	0.31 ± 0.13	0.781
Ceruloplasmin	0.37 ± 0.09	0.43 ± 0.08	0.09	0.38 ± 0.09	0.38 ± 0.09	0.37 ± 0.06	0.90	0.35 ± 0.09	0.38 ± 0.08	0.24
SGOT ^a	29.52 ± 6.22	29.50 ± 8.55	0.99	28.94 ± 5.80	30.29 ± 7.48	28.29 ± 4.82	0.70	29.33 ± 6.75	29.63 ± 6.36	0.88
SGPT ^a	12.80 ± 4.56	9.83 ± 2.32	0.12	12.28 ± 3.98	13.33 ± 4.95	10.29 ± 3.45	0.27	11.56 ± 3.94	12.94 ± 4.69	0.29
Alkaline Phosphatase	458.39 ± 164.18	358.33 ± 155.16	0.16	459.83 ± 131.81	417.96 ± 188.67	529.86 ± 144.94	0.27	434.00 ± 200.52	453.34 ± 144.19	0.69
GGT ^b	12.57 ± 4.37	15.67 ± 5.96	0.12	12.94 ± 4.18	12.79 ± 5.08	13.86 ± 4.91	0.87	14.06 ± 5.55	12.31 ± 3.99	0.20
Total Protein	7.27 ± 0.67	7.03 ± 0.57	0.40	7.53 ± 0.37	7.07 ± 0.82	7.20 ± 0.40	0.08	7.13 ± 0.47	7.31 ± 0.75	0.37
Albumin	4.12 ± 0.36	4.12 ± 0.43	0.99	4.26 ± 0.36	4.03 ± 0.33	4.16 ± 0.29	0.10	4.07 ± 0.30	4.15 ± 0.39	0.49
Urea	21.49 ± 5.71	19.33 ± 6.12	0.39	21.29 ± 6.11	20.46 ± 5.70	24.57 ± 4.20	0.25	22.83 ± 5.23	20.29 ± 5.90	0.13
Creatinine	0.45 ± 0.12	0.43 ± 0.13	0.66	0.42 ± 0.08	0.43 ± 0.12	0.55 ± 0.13	0.04*	0.42 ± 0.08	0.50 ± 0.15	0.04*

*_Serum Glutamine Oxaloacetate Transaminase Ψ_Serum Glutamine Pyruvate Transaminase €_Gamma-glutamyl Transpeptidase 0.42 ± 0.08

Table 5. Serum level of Copper and Zinc based on several drugs usages

		Copper		Zinc	
		P	P	P	P
Phenobarbital	No	0.48 ± 0.30	<0.001	0.85 ± 0.30	<0.001
	Yes	1.11 ± 0.35		0.27 ± 0.10	
Phenytoin	No	0.67 ± 0.42	<0.001	0.66 ± 0.37	<0.001
	Yes	1.13 ± 0.41		0.31 ± 0.11	
Carbamazepine	No	0.70 ± 0.45	0.021	0.64 ± 0.37	<0.001
	Yes	1.06 ± 0.34		0.34 ± 0.16	
Valproate sodium	No	0.67 ± 0.45	0.005	0.68 ± 0.38	<0.001
	Yes	0.99 ± 0.36		0.35 ± 0.15	
Clonazepam	No	0.71 ± 0.45	0.233	0.64 ± 0.37	<0.001
	Yes	0.91 ± 0.35		0.30 ± 0.06	
Nitrazepam	No	0.72 ± 0.44	0.101	0.63 ± 0.37	0.148
	Yes	1.15 ± 0.53		0.31 ± 0.18	
Topiramate	No	0.72 ± 0.45	0.201	0.62 ± 0.37	0.007
	Yes	1.13 ± 0.58		0.22 ± 0.06	
Epilim	No	0.73 ± 0.45	0.986	0.62 ± 0.37	0.348
	Yes	0.72		0.27	
Thioridazine	No	0.73 ± 0.45	0.986	0.62 ± 0.37	0.404
	Yes	0.72		0.31	
Lamotrigine	No	0.73 ± 0.45	0.674	0.62 ± 0.37	0.522
	Yes	0.54		0.38	
Primidone	No	0.71 ± 0.44	0.154	0.63 ± 0.37	0.001
	Yes	1.01 ± 0.40		0.29 ± 0.11	
Vigabatrin	No	0.73 ± 0.45	0.232	0.62 ± 0.37	0.513
	Yes	1.27		0.37	

Table 6. Onset of Epilepsy and treatment, Seizure count per month, Number of Drugs and Duration of treatment based on Type of seizure and treatment and Response to treatment

	Type of seizure		P	Response to treatment			P	Type of treatment		P
	Generalized	Partial		Non responder	Moderate responder	Complete responder		Single drug	Multiple drugs	
Onset of Epilepsy	26.36 ± 27.59	38.17 ± 43.65	0.365	26.44 ± 30.77	26.92 ± 30.22	38.00 ± 27.04	0.656	24.78 ± 23.84	29.47 ± 32.66	0.596
Seizure count per month	3.20 ± 2.74	-	-	2.50 ± 1.29	3.40 ± 3.78	-	0.666	2.33 ± 2.31	3.57 ± 2.99	0.545
The Onset of treatment	26.77 ± 27.55	38.17 ± 43.65	0.381	27.56 ± 30.69	26.83 ± 30.20	38.00 ± 27.04	0.675	24.78 ± 23.84	30.03 ± 32.56	0.552
Number of Drugs	2.00 ± 1.01	2.50 ± 0.84	0.254	2.44 ± 0.92	2.00 ± 1.02	1.43 ± 0.79	0.059	1.00 ± 0.00	2.66 ± 0.75	<0.001
Duration of treatment	32.16 ± 28.40	39.17 ± 24.89	0.569	26.78 ± 14.81	40.6 ± 35.96	24.14 ± 17.36	0.189	34.50 ± 31.43	32.16 ± 26.14	0.779

Phenytoin, Carbamazepine, Valproate sodium, Clonazepam, Topiramate and Primidone was significantly lower.

Barbeaus et al demonstrated that serum levels of copper and zinc in epileptic patients is lower than in normal people (Barbeau and Donaldson, 1974).Liu demonstrated that anticonvulsant treatment is associated with elevated serum copper level and ceruloplasmin (Liu, 1998).

In our study, the serum level of Copper in patient's winder treatment by Phenobarbital, Phenytoin, Carbamazepine and Valproate sodium was significantly higher.

Ilhan et al demonstrated that there is no significant difference between serum zinc level in epileptic patients and in normal people (Ilhan, 2004). Hamed et al demonstrated that levels of zinc and selenium in patients treated by anti-epileptic drugs, especially valproate, was higher than in the control group (Hamed, 2004).

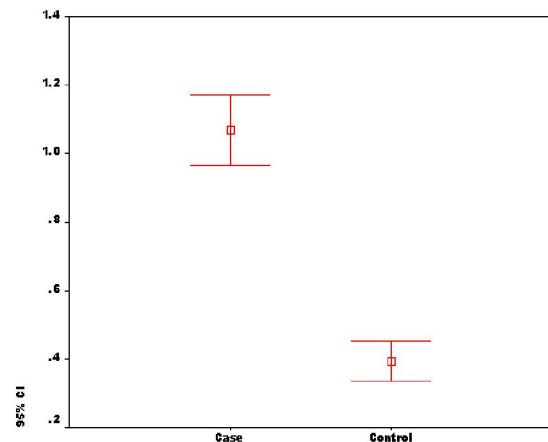

Figure 2. Distribution serum level of Copper between two groups

In our study, like the results of the above mentioned study, serum zinc levels in epileptic patients were lower than in normal people.

Verrotti's study demonstrated that the use of Phenobarbital was more effective than Sodium Valproate reducing serum zinc level of patients (Verrotti, 2002).

In this study, zinc and copper levels were 0.27 ± 0.10 and 1.11 ± 0.35 respectively in patients treated with Phenobarbital, and 0.35 ± 0.15 and 0.99 ± 0.36 respectively in patients treated with Sodium Valproate that Phenobarbital was more effective than Sodium Valproate reducing serum zinc level of patients.

Conclusion

Serum copper levels in epileptic children under drug treatment are higher than in healthy children. Also, serum zinc levels in these patients are significantly lower than in healthy people. The use of one drug or multiple drugs in the treatment of epileptic patients have made a significant difference in the levels of serum copper and zinc and also the serum level of Zinc in patient under treatment with Phenobarbital, Phenytoin, Carbamazepine, Valproate sodium, Clonazepam, Topiramate and Primidone was significantly lower and the serum level of Copper in patients under treatment by Phenobarbital, Phenytoin, Carbamazepine and Valproate sodium was significantly higher.

Acknowledgements

Special Thanks to health center of Eastern Azerbaijan province, Dr. Karamooz, Mr. Asl Rahimi, Mrs. Mahini, Mrs. Dahim, and school healthcare experts of the health center of Tabriz.

Corresponding Author:

Dr. Lida Saboktakin
Liver & Gastrointestinal diseases Research Center,
Tabriz University of Medical Sciences, Tabriz, Iran.
E-mail: Lidasaboktakin@yahoo.com

References

- 1-Gaby AR. Natural approaches to epilepsy. *Altern Med Rev* 2007;12(1):9-24.
- 2-Sołowiej E, Sobaniec W. The effect of antiepileptic drug therapy on antioxidant enzyme activity and serum lipid peroxidation in young patients with epilepsy. *Neurol Neurochir Pol* 2003;37(5):991-1003.
- 3-Tutor-Crespo MJ, Hermida J, Tutor JC. Assessment of copper status in epileptic patients treated with anticonvulsant drugs by measuring

the specific oxidase activity of ceruloplasmin. *Epilepsy Res* 2003;56(2-3):147-53.

- 4-Barbeau A, Donaldson J. Zinc, taurine, and epilepsy. *Arch Neurol* 1974;30(1):52-8.
- 5-Schott GD, Delves HT. Plasma zinc levels with anticonvulsant therapy. *Br J Clin Pharmacol* 1978;5(3):279-80.
- 6-Plum CM, Hansen SE. Studies on variations in serum copper and serum copper oxidase activity, together with studies on the copper content of the cerebrospinal fluid, with particular reference to the variations in multiple sclerosis. *Acta Psychiatr Scand Suppl* 1960;35(148):41-78.
- 7-Tutor-Crespo MJ, Hermida J, Tutor JC. Possible induction of cholinesterase in epileptic patients treated with anticonvulsant drugs: relationship with lipoprotein levels. *J Clin Pharmacol* 2004;44(9):974-80.
- 8- Sherifa A, Moustafa M, Nagla E. Blood Levels of Trace Elements, Electrolytes, and Oxidative Stress/Antioxidant Systems in Epileptic Patients. *Journal of Pharmacological Sciences* 2004; 96: 465 – 473.
- 9-Hamed SA, Abdellah MM, El-Melegy N. Blood levels of trace elements, electrolytes, and oxidative stress/antioxidant systems in epileptic patients. *J Pharmacol Sci* 2004;96(4):465-73.
- 10-Motta E, Miller K, Ostrowska Z. Concentration of copper and ceruloplasmin in serum of patients treated for epilepsy. *Wiad Lek* 1998;51(3-4):156-61.
- 11-Liu CS, Wu HM, Kao SH, Wei YH. Serum trace elements, glutathione, copper/zinc superoxide dismutase, and lipid peroxidation in epileptic patients with phenytoin or carbamazepine monotherapy. *Clin Neuropharmacol* 1998;21(1):62-4.
- 12-Ilhan A, Ozerol E, Güleç M, Işık B, İlhan N, İlhan N, Akyol O. The comparison of nail and serum trace elements in patients with epilepsy and healthy subjects. *Prog Neuropsychopharmacol Biol Psychiatry* 2004;28(1):99-104.
- 13-Verrotti A, Basciani F, Trotta D, Pomilio MP, Morgese G, Chiarelli F. Serum copper, zinc, selenium, glutathione peroxidase and superoxide dismutase levels in epileptic children before and after 1 year of sodium valproate and carbamazepine therapy. *Epilepsy Res* 2002;48(1-2):71-5.

9/24/2012

Compression cefazolin at cord clamping & before in section skin incision in decreasing the infectious complication in patients underwent cesarean section

Ezzatalsadat Haji Seid Javadi¹, Mehrnoosh Eshfahani¹, Omid Mashrabi²

¹. Assistant professor of Obstetrics and gynecology, Department of Obstetrics and gynecology, Faculty of Medicine, Qazvin University of Medical Sciences, Qazvin, Iran.

². Women's Reproductive Health Research Center, Faculty of Medicine, Tabriz University of medical sciences, Tabriz, Iran.

Mashrabi1383@yahoo.com

Abstract: Cesarean Section (CS) is associated with a high incidence of puerperal infections. The antibiotic prophylaxis in obstetric surgery may reduce infectious complications; nevertheless antibiotic prophylaxis only has proved to be effective in women with risk factors for the occurrence of infection. The aim of this study was to determine the suitable time for antibiotic injection in CS to decrease infectious side effects. In a clinical trial in 2010, 750 patients, undergone elective cesarean section, were enrolled into the study. The population was divided into two groups: Group A, including 375 women to whom antibiotic prophylaxis was applied before skin incision and Group B, including 375 women to whom antibiotic prophylaxis was applied after umbilical cord clamping. The occurrence of endomyometritis/endometritis, wound infection, febrile morbidity, total infectious morbidity, and neonatal complications were compared. In patients of group A, 356 cases (94.9%) showed no side effects, 14 cases (3.7%) had wound infection, and 5 cases (1.3%) suffered endometritis. In patients of group B, 341 cases (90.9%) showed no side effects, 24 cases (6.4%) suffered wound infection, and 10 cases (2.7%) had endometritis ($p=0.099$). Injection of Cefazolin before skin incision and during clamping the cord shows no difference in incidence of infectious side effects of cesarean section, and similar results were acquired in the two groups.

[Ezzatalsadat Haji Seid Javadi, Mehrnoosh Eshfahani, Omid Mashrabi. **Compression cefazolin at cord clamping & before in section skin incision in decreasing the infectious complication in patients underwent cesarean section.** *Life Sci J* 2012;9(4):1255-1257] (ISSN:1097-8135). <http://www.lifesciencesite.com>. 189

Keywords: Cesarean Section (CS), Cefazolin, endometritis, wound infection

1. Introduction

Caesarean Section (CS), with 1.2 million operations a year, is the most common surgery on women in the United States of America, and uterine infection and wound infection are the cause of the most postoperative morbidities in 7 – 20% of the patients (Glick and Guglielmo, 1990).

Cesarean section is associated with a high incidence of puerperal infections. The antibiotic prophylaxis in obstetric surgery may reduce infectious complications; nevertheless antibiotic prophylaxis only has proved to be effective in women with risk factors for the occurrence of infection (Figueroa Damián, 1995).

The need for ICU (60 percent higher), hospitalization (x5 times) and mortality (x2 times) are increased in these patients. CS is the most important risk factor for infection post-delivery infections, so that women undergoing CS compared with women with vaginal delivery, show 5 to 20 times more infectious complications (Glick and Guglielmo, 1990; Bertram, 2005).

Administration of prophylaxis antibiotic may reduce the incidence of such cases up to 75 percent, which applies to both elective and

emergency caesarean section operations (Glick and Guglielmo, 1990; Di Lieto, 1996).

Although antibiotics are more frequently used than cephalosporin, no best single agent has been found yet (Figueroa Damián, 1995).

Then, the first-generation cephalosporins are the most commonly used drugs that can be administered intravenously before skin incision or immediately after clamping the umbilical cord. Cefazolin belongs to the first-generation cephalosporins family. It is a derivative of 7-aminocephalosporin acid with beta-lactam ring structure and renal-excreted. Cefazolin attaches to PBPs on the bacterial cell membrane and controls the construction of cell wall and is a bactericide (Bertram, 2005; Jakobi, 1988; Phelan and Pruyon 1979).

This drug is effective on gram-positive cocci including staphylococci and streptococci, and most strains of E.Coli and Klebsiella, and commonly used surgical prophylaxis (Bertram, 2005; Yildirim, 2009).

Our aim in this study is to evaluate the different effects of Cefazolin injections before skin incision and clamping the umbilical cord on the

incidence of infectious complications in cesarean section.

2. Material and Methods

In a trial in the Department of Obstetrics and Gynecology, Qazvin University of Medical Sciences in 2010 on 750 pregnant women candidate for termination of pregnancy by CS due to obstetric emergency, the results of administration of Cefazolin, injected before skin incision and clamping the umbilical cord, were studied on the incidence of infectious complications in cesarean section.

Patients were enrolled in the study after obtaining informed consent, and randomized into two groups. Individuals with a history of allergy to Cefazolin, PROM for more than 6 hours, and also diabetic and obese patients, and those who were treated with antibiotics and corticosteroids for any reason during the week prior to surgery were excluded from the study.

750 patients, undergone elective cesarean section in 2010 were enrolled into the study. The population was divided into two groups: Group A, including 375 women to whom antibiotic prophylaxis was applied before skin incision, and Group B, including 375 women to whom antibiotic prophylaxis was applied after umbilical cord clamping. The occurrence of endomyometritis/endometritis, wound infection, febrile morbidity, total infectious morbidity, and neonatal complications were compared.

One week after discharge and at the day of removing sutures, patients were examined for wound and uterine infections.

3. Results

Mean age of the patients was 26.19 ± 5.31 years in the test group (Group A) and 26.75 ± 5.62 years in the control group (Group B), that there was no significant difference in age of patients between the two groups (Table I).

Mean gravid of patients was 1.991.05 in the test group (Group A) and 2.12 ± 1.14 in the control group (Group B), that there was no significant difference in Gravidity between the two groups (Table II).

The reason of CS in the patients in test group (Group A) and control group (Group B) included the lack of progress in delivery, repetitious CS, premature disposal of Meconium, Preeclampsia, infertility, breech demonstration, macrosomia, old age, multipara, and transverse presentation of face and brow, that there was no significant differences in the reason of CS between the two groups. Of the total patients, 697 cases (92.9 percent) had no infectious complications, 38 cases (5.1 percent)

suffered Wound infection and 15 cases (2 percent) had uterine infection. The frequency of postoperative complications is shown in Table III.

Table I: Age distribution of patients between two groups

Age	Group		Total
	Case	Control	
<15	1(3%)	0(0%)	1(1%)
15-20	35(9.3%)	41(10.9%)	76(10.1%)
20-25	111(29.6%)	93(24.8%)	204(27.2%)
25-30	113(30.1%)	100(26.7%)	213(28.4%)
30-35	87(23.2%)	107(28.5%)	194(25.9%)
35-40	24(6.4%)	28(7.5%)	52(6.9%)
>40	4(1.1%)	6(1.6%)	10(1.3%)

Table II: distribution of patient's Gravidity between two groups

Gravidity	Group		Total
	Case	Control	
1	137(36.5%)	135(36%)	272(36.3%)
2	157(41.9%)	123(32.8%)	280(37.3%)
3	39(10.4%)	75(20%)	114(15.2%)
4	31(8.3%)	26(6.9%)	57(7.6%)
5	9(2.4%)	11(2.9%)	20(2.7%)
6	2(0.5%)	5(1.3%)	7(0.9%)

Table III: Infection's complications of patients between two groups

	Group		Total
	Case	Control	
Wound infection	14(3.7%)	24(6.4%)	38(5.1%)
Endometritis	5(1.3%)	10(2.7%)	15(2%)

4. Discussion

The only most important risk factor for postpartum maternal infection is cesarean section (Smaill and Gyte, 2010).

The findings of this study show that injection of Cefazolin before skin incision and at the time of clamping the umbilical cord makes no significant difference in incidence of infectious postoperative complications.

In a study by Wax(1997) at the University of Virginia, results similar to ours were obtained (Wax, 1997). In this study, he compared the effect of injection of single dose of Cefazolin before surgery and after clamping the umbilical cord and observed no significant difference in the incidence of primary and secondary infectious complications (Wax, 1997).

In a study by Cunningham in 1983 on 642 patients, the results obtained were also similar to ours. He studied the effect of administration of Cefazolin before surgery and after clamping the umbilical cord and observed no significant difference in the incidence of infectious complications in neither of case and control groups (Cunningham,1993).

In a double-blind interventional study by Skosolian at the Department of Medicine, USC, on

357 patients divided into two groups of case (group A) and control (group B), similar results were obtained on the incidence wound infection, while no significant difference was observed between the two groups of case (group A) and control (group B) in the incidence of uterine infection (Sullivan, 2007).

In a study by Rouzi in 2000 in Saudi Arabia, they studied 440 cases of emergency and elective CS and expressed that Cefazolin injection is more effective in reducing most of infectious complications in cases of emergency CS (Rouzi, 2000).

In a study by Thigpen et al at the University of Mississippi Medical Center, results similar to ours were obtained where they stated that there was no difference in maternal infectious morbidity whether antibiotics were given before skin incision or at cord clamping (Thigpen, 2005).

In the study of Dimitrov, the infectious complication incidence in patients receiving Cefazolin was 17.1% (Dimitrov, 2001).

In our study, the incidence of infectious complications was observed in 7.06% of patients, that in comparison to the above mentioned study, better results were obtained in our study.

Corresponding Author:

Dr. Ezzatalsadat Haji Seid Javadi
Department of Obstetrics and gynecology, Faculty of Medicine, Qazvin University of Medical Sciences, Qazvin, Iran.
E-mail: mashrabi1383@yahoo.com

References

- 1- Glick M, Guglielmo BJ. Antibiotic prophylaxis in cesarean section. *DICP* 1990; 24(9):841-6.
- 2-Figueroa Damián R, Ortíz Ibarra FJ, Labastida Domínguez VM, Villagrana Zesati R, García Benítez CQ, Arredondo García JL. Ceftriaxone vs. cefazolin in obstetrical surgical prevention. *Ginecol Obstet Mex* 1995; 63:302-7.
- 3-Bertram G, Katzung A, Anthony J. Katzung and Trevor's Pharmacology. 6th edition, Hayyan culture publishing, New York, 2005; 393-95.
- 4-Di Lieto A, Albano G, Cimmino E, Pontillo M, Gallo F, Micalef R, Paladini A. Retrospective study of postoperative infectious morbidity following cesarean section. *Minerva Ginecol* 1996; 48(3):85-92.
- 5- Jakobi P, Weissman A, Zimmer EZ, Paldi E. Single-dose cefazolin prophylaxis for cesarean section. *Am J Obstet Gynecol* 1988; 158(5):1049-52.
- 6- Phelan JP, Pruyun SC. Prophylactic antibiotics in cesarean section: a double-blind study of

cefazolin. *Am J Obstet Gynecol* 1979; 133(5):474-8.

- 7-Yildirim G, Gungorduk K, Guven HZ, Aslan H, Celikkol O, Sudolmus S, Ceylan Y. When should we perform prophylactic antibiotics in elective cesarean cases? *Arch Gynecol Obstet* 2009; 280(1):13-8.
- 8-Smaill FM, Gyte GM. Antibiotic prophylaxis versus no prophylaxis for preventing infection after cesarean section. *Cochrane Database Syst Rev* 2010; 1:CD007482.
- 9- Wax JR, Hersey K, Philput C, Wright MS, Nichols KV, Eggleston MK, Smith JF. Single dose cefazolin prophylaxis for postcesarean infections: before vs. after cord clamping. *J Matern Fetal Med* 1997; 6(1):61-5.
- 10- Cuningham F, Leveno K, Roark M. Administration of cefazolin prior skin incision & after at cord clamping in preventing infections morbidity. *Obstet gynecol* 1983; 43(3):252-61.
- 11-Sullivan SA, Smith T, Chang E, Hulsey T, Vandorsten JP, Soper D. Administration of cefazolin prior to skin incision is superior to cefazolin at cord clamping in preventing postcesarean infectious morbidity: a randomized, controlled trial. *Am J Obstet Gynecol* 2007; 196(5):455.e1-5.
- 12- Rouzi AA, Khalifa F, Ba'aqueel H, Al-Hamdan HS, Bondagji N. The routine use of cefazolin in cesarean section. *Int J Gynaecol Obstet* 2000; 69(2):107-12.
- 13- Thigpen BD, Hood WA, Chauhan S, Bufkin L, Bofill J, Magann E, Morrison JC. Timing of prophylactic antibiotic administration in the uninfected laboring gravida: a randomized clinical trial. *Am J Obstet Gynecol* 2005; 192(6):1864-8; discussion 1868-71.
- 14-Dimitrov A, Pünevská M, Dikov I, Nikolov A, Kostov I. Prophylaxis with tercef of infection-related complications after cesarean section. *Akush Ginekol (Sofia)* 2001;42(2):33-7.

9/26/2012

Comparison of hematocrit concentration after cesarean section between two methods: general anesthesia Vs spinal anesthesia

Ezzatalsadat Haji Seid Javadi¹, Shamsi Niazi¹, Aamir Javadi², Omid Mashrabi³

1. Assistant professor of Obstetrics and gynecology, Department of Obstetrics and gynecology, Faculty of Medicine, Qazvin University of Medical Sciences, Qazvin, Iran.

2. Faculty of Medicine, Qazvin University of Medical Sciences, Qazvin, Iran.

3. General Medicine, Women's Reproductive Health Research Center, Faculty of Medicine, Tabriz University of medical sciences, Tabriz, Iran.
Mashrabi1383@yahoo.com

Abstract: Comparing hematocrit concentration after cesarean section (CS) between general and spinal anesthesia. In a clinical trial in 2010 in the Department of Obstetrics and Gynecology, Qazvin University of Medical Sciences on 200 pregnant women elected for pregnancy termination by CS due to obstetric emergency, hematocrit changes in patients with general and spinal anesthesia were studied before and after CS. Hct-Hb content was significantly reduced in patients with general anesthesia (4.2 and 1.6) compared to spinal anesthesia (3.2 and 1) ($p < 0.05$). Mean hematocrit loss in spinal anesthesia was significantly lower than in general anesthesia ($p = 0.035$). The results by the current study showed that hematocrit loss after CS in patients with general anesthesia is higher than in patients with spinal anesthesia. However, physicians should well consider the method of anesthesia, especially in high risk patients, to reduce the severity of postpartum hemorrhage and hematocrit loss.

[Ezzatalsadat Haji Seid Javadi, Shamsi Niazi, Aamir Javadi, Omid Mashrabi. **Comparison of hematocrit concentration after cesarean section between two methods: general anesthesia Vs spinal anesthesia.** *Life Sci J* 2012;9(4):1258-1260] (ISSN:1097-8135). <http://www.lifesciencesite.com>. 190

Keywords: ean Section; Spinal Anesthesia; General Anesthesia; Hemoglobin; Hematocrit

1. Introduction

Postpartum hemorrhage still remains as one of the main causes of maternal mortality. With hospital delivery and availability of blood for transfusion, the maternal mortality rate has dramatically dropped down (Ueyama, 2010).

Unfortunately, despite improving outcomes, the poor and minorities still lose their lives, highly and in a tragic way, due to hemorrhage and the subsequent problems. Among the diseases underlying or intensifying postpartum hemorrhage, general anesthesia and epidural anesthesia (halogenated agents) have also been mentioned (Cunningham, 2010).

Cesarean section (CS) is one of the most common surgeries in women (Van Houwe, 2006). The option of general or epidural anesthesia for CS depends on mother's desire and maternal-embryonic conditions (Soens, 2008).

Postpartum hemorrhage is an emergency condition⁷ and the cause of 33% of maternal mortality cases (Vimala, 2006). In countries with high prevalence of anemia during pregnancy, even partial reduction of postpartum hemorrhage is clinically very important (Hong, 2003).

Hong et al demonstrated that there is no significant difference in the hemodynamic and blood

loss in patients undergoing CS with general or epidural anesthesia ($p < 0.05$) (Hong, 2003).

Evaluating 341 CS patients, Lertakyamane et al (1999) demonstrated that the amount of blood loss in patients with general anesthesia was significantly higher (Lertakyamane, 1999).

Andrew et al demonstrated that halogenated drugs used for general anesthesia in CS increases the amount of blood loss during surgery (Andrews, 1992).

Gilstrap et al (1987) demonstrated that increased blood loss during surgery and after using halogenated compounds is due to reduced uterine contractions (Gilstrap, 1987).

The aim of this study is to evaluate changes of hematocrit (Hct) in patients undergoing general anesthesia and spinal anesthesia before and after CS.

2. Material and Methods

A clinical trial in 2010 in the Department of Obstetrics and Gynecology, Qazvin University of Medical Sciences conducted on 200 pregnant women elected for termination of pregnancy by CS due to obstetric emergency, hematocrit changes in patients with general anesthesia and spinal anesthesia were studied before and after cesarean section

After obtaining informed consent, patients were enrolled into the study and randomly divided

into two groups of A, with general anesthesia, and B, with epidural anesthesia for CS.

Patients with heart problems, clotting disorders, anemia, preeclampsia, atonia, polyhydramnios, multipara and macrosomia were excluded from the study. Obviously, patients who had previously chosen the type of anesthesia were also excluded.

HCT at the day of surgery and 24 hours after surgery was checked. The rate of Hct changes in both methods of general and epidural anesthesia was calculated in percentages and compared.

3. Results

In this study, 200 pregnant women elected for CS were studied in two groups of 100 patients. Mean age was 27.4 ± 5.1 in group A (with general anesthesia) and 27.3 ± 5.3 in group B (with spinal anesthesia), that there was no significant difference in age between the two groups of patients ($p > 0.05$).

Mean duration of surgery was 40.8 ± 9 minutes for patients in group A (with general anesthesia) and 42.7 ± 9.2 for patients in group B (with spinal anesthesia), that there was no significant difference in duration of surgery between the two groups of patients ($p = 0.79$).

Parity, as one of hemorrhage risk factors, was not significantly different between the two groups of patients and two groups were quite similar ($p = 0.56$).

Mean hemoglobin and hematocrit before and after CS in patients of the two groups is shown in Table 1 and 2. According to the results, mean loss of hemoglobin and hematocrit in patients of group A were 1.6 ± 0.1 and 4.2 ± 1 respectively which was significantly reduced after surgery. In patients of group B, mean loss of hemoglobin and hematocrit were 1.05 ± 0.2 and 3.2 ± 0.5 which was significantly reduced after surgery.

Mean loss of hemoglobin was 1.05 ± 0.2 in group A and 1.3 ± 0.1 in group B, that the loss of hemoglobin in patients with general anesthesia (group A) was significantly higher than in patients with spinal anesthesia (group B) ($p = 0.017$).

Mean loss of hematocrit in patients with spinal anesthesia (group B) was significantly lower than in patients with general anesthesia (group A) ($p = 0.035$).

4. Discussions

Spinal anesthesia is the most common type of epidural anesthesia used in CS. Most physicians believe that in most cases, general anesthesia is more reliable for a rapid anesthesia for CS. Actually, the use of spinal anesthesia is increasing as an alternative

to general anesthesia in all patients (except emergency cases) (Vimala, 2006).

Analysis of data from this study showed that hemoglobin and hematocrit levels in both groups of general and spinal anesthesia had significantly dropped as compared with those before surgery ($p < 0.05$).

Table 1. Hemoglobin of patient at before and after surgery in both groups

	Hemoglobin		P (before/after)
	Before surgery	After surgery	
General anesthesia	12.9 ± 1.3	11.37 ± 1.3	< 0.001
Local anesthesia	12.9 ± 1.2	11.85 ± 1.42	< 0.001
P(between two groups)	> 0.05	0.017	-

Table 2. Hematocrit of patient at before and after surgery in both groups

	Hematocrit		P (before/after)
	Before surgery	After surgery	
General anesthesia	37.9 ± 2.7	33.7 ± 37	< 0.001
Local anesthesia	38 ± 2.9	34.8 ± 3.6	< 0.001
P(between two groups)	> 0.05	0.035	-

This means that surgery and postoperative hemorrhage lead to loss of hemoglobin and hematocrit after surgery, since 750-1000 ml of blood is usually lost during CS (Miller, 2004).

Most researches on blood loss and reduction of hemoglobin and hematocrit levels after cesarean section show that patients with general anesthesia have less hematocrit after surgery; i.e. the blood loss during CS is higher in patients with general anesthesia. In these studies it is suggested that the halogenated compounds added to Nitro Oxide to reduce the patient's awakens in general anesthesia, may increase blood loss by reducing uterine contractions (Afolabi, 2003).

The results of the current study showed a significant difference in rate of hemoglobin loss after surgery (difference in the mean hemoglobin before and after surgery) in the two study groups ($p = 0.017$) which is due to more blood loss in general anesthesia using halogenated compounds; since these compounds cause reduced uterine contractions, uterine relaxation and increased blood loss.

Andrew et al (1992) demonstrated that halogenated drugs used for general anesthesia in CS may increase the amount of blood loss, and postoperative hematocrit level was lower in patients with general anesthesia (Andrews, 1992). The result of above mentioned study is similar to our study.

Besides, in the study of Hong et al (2003), it has been suggested that there was no significant difference in blood loss between patients with general and epidural anesthesia, which is unlike the results of the current study (Hong, 2003).

Studies by Hood et al (1990) in the US have results similar to our study that halothane increases the blood loss by reducing uterine contractions (Hood, 1990).

In the study of Gilstrap et al (1987), it has been suggested that the halogenated compounds which may increase blood loss due to the reduction of uterine contractions have been identified in this study, using which will decrease hematocrit level. This result is similar to our study; however, the loss of hematocrit observed in the above mentioned study was higher than in our study (Gilstrap, 1987).

The results by the current study showed that hematocrit loss after CS in patients with general anesthesia is higher than in patients with spinal anesthesia.

However, physicians should well consider the method of anesthesia, especially in high risk patients, to reduce the severity of postpartum hemorrhage and hematocrit loss.

Patients also learn more about the types of anesthesia and their consequent complications and choose wisely.

Conclusion

Hemoglobin and Hematocrit content were significantly reduced in patients with general anesthesia (4.2 and 1.6) compared to spinal anesthesia (3.2 and 1) ($p < 0.05$). Mean hematocrit loss in spinal anesthesia was significantly lower than in general anesthesia ($p = 0.035$). The results by the current study showed that hematocrit loss after CS in patients with general anesthesia is higher than in patients with spinal anesthesia.

However, physicians should well consider the method of anesthesia, especially in high risk patients, to reduce the severity of postpartum hemorrhage and hematocrit loss.

Corresponding Author:

Dr. Ezzatalsadat Haji Seid Javadi
Department of Obstetrics and gynecology, Faculty of Medicine, Qazvin University of Medical Sciences, Qazvin, Iran.
E-mail: mashrabi1383@yahoo.com

References

- 1-Ueyama H. Controversial issues regarding general anesthesia for cesarean section. *Masui* 2010; 59(3):357-61.
- 2- Cunningham G, Leveno KJ, Bloom SL, Hauth JC, Gilstrap LC, Wenstrom KD. *William's Obstetrics*, McGraw-Hill Professional, Philadelphia, 2010; 320-5.
- 3-Van Houwe P, Heytens L, Vercruyssen P. A survey of obstetric anaesthesia practice in Flanders. *Acta Anaesthesiol Belg* 2006; 57(1):29-37.
- 4-Soens MA, Birnbach DJ, Ranasinghe JS, van Zundert A. Obstetric anesthesia for the obese and morbidly obese patient: an ounce of prevention is worth more than a pound of treatment. *Acta Anaesthesiol Scand* 2008; 52(1):6-19.
- 5-Vimala N, Mittal S, Kumar S. Sublingual misoprostol versus oxytocin infusion to reduce blood loss at cesarean section. *Int J Gynaecol Obstet* 2006; 92(2):106-10.
- 6-Hong JY, Jee YS, Yoon HJ, Kim SM. Comparison of general and epidural anesthesia in elective cesarean section for placenta previa totalis: maternal hemodynamics, blood loss and neonatal outcome. *Int J Obstet Anesth* 2003; 12(1):12-6.
- 7-Lertakyamane J, Chinachoti T, Tritrakarn T, Muangkasem J, Somboonnanonda A, Kolatat T. Comparison of general and regional anesthesia for cesarean section: success rate, blood loss and satisfaction from a randomized trial. *J Med Assoc Thai* 1999;82(7):672-80.
- 8-Andrews WW, Ramin SM, Maberry MC, Shearer V, Black S, Wallace DH. Effect of type of anesthesia on blood loss at elective repeat cesarean section. *Am J Perinatol* 1992;9(3):197-200.
- 9-Gilstrap LC 3rd, Hauth JC, Hankins GD, Patterson AR. Effect of type of anesthesia on blood loss at cesarean section. *Obstet Gynecol* 1987;69(3 Pt 1):328-32.
- 10-Miller RD, Pardo M. *Basics of Anesthesia*, W.B. Saunders Company, Philadelphia, 2004; 458-62.
- 11-Afolabi BB, Kaka AA, Abudu OO. Spinal and general anaesthesia for emergency caesarean section: effects on neonatal Apgar score and maternal haematocrit. *Niger Postgrad Med J* 2003; 10(1):51-5.
- 12-Hood DD, Holubec DM. Elective repeat cesarean section. Effect of anesthesia type on blood loss. *J Reprod Med* 1990; 35(4):368-72.

10/2/2012

A Survey Of Lean Implementation Gap Analysis In Public Sector Organizations

Irfan Ghalib *, Mujtaba Hassan Agha**, Shafqat Hameed, ***Muhammad Abbas Choudhary

* National University of Sciences & Technology (NUST), Islamabad, Pakistan

** Department of Mechanical Engineering, Mohammad Ali Jinnah University, Islamabad, Pakistan

***University of Engineering and Technology (UET), Taxila, Pakistan

Shafqat.hameed@ceme.nust.edu.pk

ABSTRACT: This paper is an endeavor to highlight/identify the areas of improvement in the production systems of typical public sector organizations in view of the implementation of Lean Manufacturing practices to improve Competitiveness. To serve the purpose, a survey has been conducted to get the consensus of managers belonging to various tiers of management of these organizations through responding to a questionnaire. This questionnaire, based on the importance of various features of Lean Manufacturing and their actual effective implementation in respective organizations, has been used to collect the data from which certain results have been inferred. The research signifies the fact that, although most of these public sector organizations enjoy the status of holding ISO Certified Quality Management System Standards, still there exists a capacity for Business Process Improvement in their production systems owing to various Lean Implementation Gaps and lapses. This can ultimately prove complementary to the policy of Continuous Quality Improvement and other principles of Quality Management System Standard.

[Irfan Ghalib, Mujtaba Hassan Agha, Shafqat Hameed, Muhammad Abbas Choudhary. **A Survey Of Lean Implementation Gap Analysis In Public Sector Organizations.** *Life Sci J* 2012;9(4):1261-1269] (ISSN:1097-8135). <http://www.lifesciencesite.com>. 191

Key words: Lean Manufacturing, QMS, Productivity, Management, Quality.

1. INTRODUCTION

Public sector organizations operate under resource constrained and less organizational, technological and managerial proficient environment (Thong et al., 2000) as compared to their private sector counterparts. Moreover, public sector organizations have a hierarchical-command structure which is relatively more rigid (Gullege and Sommer, 2002), and a culture that places less emphasis on customer focus or alignment of business processes with customer expectations (Zaheer and Mushtaq, 2008). This study is an effort to bring into light the fact that in most of the public sector organizations, even if they claim to be registered with the prestigious ISO Quality Management System (QMS) Standards, still there is enough room to impart Lean Manufacturing Practices in the system to actually help and complement the QMS in vogue.

According to Robitaille (2004), in truth, good lean practices complement a QMS, as efficient, well-implemented supplier monitoring programs, for example, might initially incur costs but will ultimately reap benefits from more consistent and reliable vendor performance. This, in turn, results in fewer returns, fewer costly interruptions to production schedules and a decreased risk of defects reaching customers. Nevertheless, in public sector organizations, owing to the inefficiencies of performance in terms of poor quality, time and money wastages, inordinate delays, cumbersome channels and financial mismanagement (Zaheer and Mushtaq, 2008), there is an overwhelming

chance that several important areas of production may certainly be overlooked with a point of view of Lean Standards. In fact, Hammer and Champy (1993) relate the fundamental rethinking and radical redesign of business processes to achieve Dramatic improvements with critical, contemporary measures of performance, such as Cost, Quality, Service, and Speed. At the same time, as emphasized by Donovan (2011) the superior Competitive Performance demands a holistic view based on broader perspective of the business to deal with poor delivery performance, long lead times, higher costs, lower market shares, and ever declining sales volumes.

All these facts signify a need to eliminate the non-value-added activities and waste generated in the existing production system by identifying the areas to be subjected to constant monitoring and improvisation in order to achieve superior competitive performance. For this purpose, a survey has been conducted by designing a questionnaire addressing some of the cardinal areas of Lean Manufacturing with representative questions, and collecting the opinion of the managers from different tiers of at least 10 diverse public sector organizations. The survey is a useful means to reveal the gap between the importance of a certain feature of Lean Manufacturing (in terms of their contribution to superior competitive performance) and their actual implementation status on ground. The outcome of this survey is a direct assessment of the status of organization that how Lean its existing business processes are, and to elucidate the

especial areas of consideration to be subjected to rigorous Business Process Improvement.

2. LITERATURE REVIEW

2.1. Definition of Lean:

Lean Manufacturing, while known by many names, allows manufacturers to be fast and nimble enough to quickly react to changes in customer demand and perform it with little inventory (Donovan, 2011). Public sector or private Sector, organizations are now more and more conscious of piling up of inventories on shop floor in the shape of raw materials, work-in-process inventory and over-production, considering it a hindrance to the smooth and streamlined flow of production.

Lean is an American term created to define the application of some techniques derived from a study of the Toyota Production System. In essence, each activity is examined to identify and eliminate those wasteful activities that are not adding value. In addition, some activities may be combined or rearranged to make the flow more efficient. Increasingly, Lean practitioners are also creating value stream models that represent the flow of activities from the customer's order to delivery (Harmon, 2011). Lean manufacturing is a generic process management philosophy, whose principles are pull processing, perfect first-time quality, waste minimization, continuous improvement, flexibility, building and maintaining a long term relationship with suppliers, automation, load leveling and production flow and visual control (Executive Development Ltd, 2007)

Generally, 'Lean' is considered to be the newest trend in vogue mainly related to cost-reduction through elimination of non-value-added activities and is equally applicable to manufacturing setups, projects and proposals. Though facing sort of cynicism related to its implementation problems, certain high-profile high-success executions under the auspices of Toyota has made it quite attractive in the eyes of a considerable number of business owners.

Overall, 'Lean' is understood as a means of elimination of waste, quality improvement, and production cost and time reduction. The other acknowledged aspect of this phenomenon is production flow improvement or smoothness of work through production line balancing. An initiative for smooth production flow automatically exposes quality problems and culminates into waste reduction. Lean implementation is therefore focused on getting the right things, to the right place, at the right time, in the right quantity to achieve perfect work flow while minimizing waste and being flexible and able to change (Executive Development Ltd, 2007). All efforts in 'Lean Manufacturing' focus on making

things simple to apprehend, and become doable and manageable.

2.2. Background and History:

Frank Gilbreth, the motion efficiency expert, is the pioneer in identifying the concept of waste being built into jobs and then taken for granted. Frederick Winslow Taylor, the father of scientific management, established the phenomena of standardization and best practice deployment. In his famous book, 'Principles of Scientific Management' (1911), he elaborates the notion as "And whenever a workman proposes an improvement, it should be the policy of the management to make a careful analysis of the new method, and if necessary conduct a series of experiments to determine accurately the relative merit of the new suggestion and of the old standard. And whenever the new method is found to be markedly superior to the old, it should be adopted as the standard for the whole establishment".

The advent of industrial revolution a century ago replaced craft production with mass production. Henry Ford is considered to be the manufacturing's original 'Lean' thinker. Ford (My Life and Work, 1922), propounded a description that covered the entire concept of waste. Ford's continuous flow method proved highly effective in production of a single, repetitive item. With increase in diversity of demand, the concept loosened its relevance. The history marks the point as the induction of larger machines, particularly in North America, where larger batches of product were preferred to be manufactured. In contrast, Japanese producer Toyota was developing a paradigm supporting smaller batch production and just-in-time delivery i.e. producing only necessary units in necessary quantities at precisely the right time (Kinaxis Corp, 2011), and hence reduction in inventory and product cost with increase in productivity. The concept of 'Lean' stemmed from the business environment reigning the Post War economy of Japan. It occurred to Taiichi Ohno while visiting the US supermarkets that scheduling of work must be driven by actual sales rather than by production or sales targets.

2.3. Characteristics of public sector organizations

Johnson et al, (2005) have highlighted the role of public sector organizations in contrast with the private sector as engaged with multiple objectives and limitations regarding their ability to generate new revenue, with ultimate control over their existence held by publicly elected bodies. Kay (1995) further elaborates this aspect as for public sector organization, the added value or benefits are not retained by the firm, but instead are distributed to its member or the community. This presents the paradox of creating

knowledge and services and let them pass to the public for their good instead of maximizing private profit. McAdam and Donaghy, (1999) discuss the specific characteristics of public sector organizations as:

- Rigid hierarchies.
- Culture and values promoting continuity, predictability, and fairness instead of change and innovation.
- Multiple stakeholders for many processes – boundaries cannot be crossed, stakeholders and processes often extend beyond the boundaries of a department or agency.
- Sudden and dramatic changes in policy possible.
- Overlap of initiatives.
- Broader scope of activities – unrealistic expectations.

2.4. 'Lean' as a Requirement

Today, Lean supply chain performance must become the goal of every manufacturer. Creating the Lean supply chain by streamlining business and production processes to significantly reduce cycle time, decrease inventories, lower costs and increase customer service has become the mandate for survival (Donovan, 2011). Lean manufacturing imply identifying and eliminating non-value-adding activities in design, production, supply chain management, and order processing by analyzing the existing value stream and developing a Future State Implementation Plan. The idea of lean is founded on the following principles (Kinaxis Corp, 2011):

- Define and pursue what is value in the eyes of the customer
- Thorough analysis and identification of the value stream and eliminate waste
- Value flow driven by the pull of the market demand
- Participation and empowerment of employees
- Continuously improve in pursuit of perfection

2.5. Types of 'Wastes'

The 'Lean' considers every such activity a waste that is non-value-added, hindering the process flow due to unevenness or causing overburden to the production system. The various writers and experts [(Donovan, 2011); (Harmon, 2011); (Executive Development Ltd, 2007); (Kinaxis Corp, 2011)] identify the following activities as deadly wastes:

- Overproduction
- Inventory
- Waiting

- Conveyance
- Motion
- Unnecessary Processing and Setup:
- Defects
- People's Skills

2.6. 'Lean' and QMS

Robitaille (2004) signifies ISO 9001 as an elegant, albeit generic, model that applies remarkably well to a diverse array of organizations, and hence a certificate signifies a commitment to quality. Robitaille (2004) further elaborates that it projects a level of excellence that helps maintain customers' confidence in a product. In fact, good lean practices complement a QMS. Efficient, well-implemented supplier monitoring programs, for example, might initially incur costs but will ultimately reap benefits from more consistent and reliable vendor performance. This, in turn, results in fewer returns, fewer costly interruptions to production schedules and a decreased risk of defects reaching customers.

Puglielli (2008) explains the subject further to clarify the jurisdiction and need of the two concepts as, when a company is growing, compliance to the ISO QMS Standard is imperative to ensure that the controls they have in place are adequate to support their growing needs. But on the other hand, when a company stops any further growth with its systems and controls matured to full extent, the company is compelled to focus on 'Lean' initiatives independent of its QMS.

2.7. Management Principles of QMS and Lean Best Practices

Quality Management System encompasses the principles that are universal to industry and business. Though further varied definitions of these are possible to meet the requirements of a specific industry, still the element of generality is characteristic with Quality Management System. Only standard of quality has to be defined first by the organization itself and then those standards have to be met accordingly. Following are the eight management principles (Westgard, 2005) pursued by the Quality Management System:

- i. *Customer-focused organization*; the concept of Customer Satisfaction is central to ISO QMS. Organization is expected to cater for the customer needs both current and future.
- ii. *Leadership*; management commitment and vision provide direction to the whole organization helping greatly to focus on the relevant issues.
- iii. *Involvement of people*; complete participation of employees is must in successful implementation of ISO and maintaining the

- gains of an ISO certification. Decentralization in this respect could be more beneficial to give a chance to employees to bring forward their underutilized skills and knowledge.
- iv. *Process approach*; management can use several quality and statistical tools and techniques to improve the processes as a set of interrelated activities transforming inputs into outputs, as identified by ISO.
 - v. *System approach*; ISO believes in establishing a System as a collection of interrelated processes, easy to be directed towards specific objective in an efficient manner.
 - vi. *Continual improvement*; ISO, as a system, is based on continuous improvement and innovation rather than a one-time exercise.
 - vii. *Factual approach to decision making*; in-time decision making is must and mainly depends on accuracy of data collection and correct analysis as emphasized by ISO implementation process.
 - viii. *Mutually beneficial supplier relationships*; ISO standards are designed to promote the abilities of organizations to create value and hence support profit making.

As per Donovan (2011), Lean Manufacturing is attributed with quick response, lower inventories, higher profits, better quality and total customer satisfaction. Thus, superior world class competitive performance needs following practices to be rigorously followed to boost up the performance of the respective areas:

- a. Management's commitment.
- b. Time Cycle reduction.
- c. Inventory reduction.
- d. Customer focus.
- e. Structured flow.
- f. Overall performance improvement in terms of periodic product design review etc.
- g. Employee participation.
- h. Quality planning and cost control.
- i. Information technology.
- j. Total preventive maintenance.

Here it can be observed that the two approaches have a lot common and pursuing ISO certification doesn't imply avoiding Lean. In fact, these two approaches offer diverse advantages and benefits to an organization without necessarily intersecting each other's objectives and interests, instead complementing each other. The most important thing to learn is that the two approaches are not mutually exclusive. ISO certification should not prevent an organization from implementing Lean. However, ISO must provide the umbrella, directing towards broader

goals and paving the way for gross waste elimination through Lean implementation and hence improving the value stream. The most important factors to be kept in focus, conducive to parallel implementation of the two approaches, are extensive training and significant cultural changes.

3. METHODOLOGY

3.1. Research Approach

In this study, qualitative approach has been used to collect the data through a questionnaire, designed and derived from the Donovan (2011) model, and modified according to the needs of the ten Public Sector Organizations focused for the purpose. Managers belonging to diverse tiers of the Management of these 10 organizations have been targeted to reach at a consensus in identifying the areas where the gaps and lapses actually occur with respect to the significance of that particular area, and the actual status of implementation.

3.2. Questionnaire Type

The current study has employed a questionnaire comprising of 20 closed ended questions for ease of answering, standardization and statistical analysis. The design of the questionnaire is such that each major area of Lean Manufacturing has been addressed with two representative questions to be answered. In total, there are 20 closed ended questions aiming at respondent's feelings about the effective implementation of a Lean Manufacturing feature. The response is in two parts as follows,

- a. *Feature's Importance*: in this part, the respondents were urged to assess all the features by using a 5 – point LIKERT scale, ranging from “1 – Insignificant” to “5 – Very Important”.
- b. *Implementation in Organization*: this part reflected the respondent's opinion about the actual implementation level of that particular Lean Manufacturing feature in the respective organization.

The questionnaire is divided into ten sections, each corresponding to a specific area or feature concerned with Lean Manufacturing, including,

- i. Productivity
- ii. Inventory
- iii. Structured Flow
- iv. Performance Improvement
- v. Employee Participation
- vi. Management
- vii. Quality
- viii. Customer Focus

- ix. Information Technology
- x. Total Preventive Maintenance

3.3. Sample Selection and Size

Ten Public Sector Organizations with a cumulative strength of about 350 Managers, belonging to top, middle and lower levels, were targeted in this research. For a sample size of 112 respondents, 200 questionnaires were distributed. Out of 200, 120 questionnaires were received duly filled in all respect. Hence the response rate remained 60%.

3.4. Brief Method to Calculate Lean Implementation Gap

Following is the method to calculate the Lean Features' Implementation Gap.

- a. There are ten dimensions of Lean Manufacturing.
- b. Each dimension is characterized by two representative questions.
- c. Response to these questions is divided into two sections i.e. 'Importance' and 'Implementation'.
- d. Response to 'Importance' and 'Implementation' varies on a Likert Scale from 1 – 5.
- e. $\text{Lean Implementation Gap} = \text{Implementation} - \text{Importance}$.
- f. A negative number reflects an existence of a gap between the effective implementation of that particular feature as compared to its significance. A positive number represents a satisfactory status.
- g. Calculate gap for each question.
- h. Determine the average gap for all questions of a particular dimension.
- i. Calculate the average gap for all the ten dimensions. This should be the average Lean Implementation Gap for single respondent.
- j. The individual Lean Implementation Gap scores for all respondents might be calculated to determine the overall Lean Implementation Gap present in the system by taking their average.
- k. The dimension with the lowest average gap score will be the most Critical Dimension.

4. RESULTS AND ANALYSIS

A brief description of the response trend of 120 respondents is as shown in the Table 1

The response to brief remained healthy as an appropriate proportion of all the three major categories of Management has been obtained contributing towards a more reliable result to be inferred.

Table 1. Response Rate

Respondent's Category	Total	Cumulative	Percentage
Managing Directors and Board Members	12	12	10
General Managers	36	48	30
Assistant Managers and Managers	72	112	60
Total	120	-	100.0

The data generated by the response of all the 120 respondents of the Questionnaire has been depicted in a graphical manner as shown in the Figure 1. The abscissa depicts the Lean Features, while ordinate depicts the average Lean Implementation Gap as a corresponding negative number, following the method as described earlier to calculate the overall Lean Implementation Gap for each Lean Feature. Each individual bar is topped by the relevant value for ease of comprehension. The graph encompasses the whole picture of the current status of the production systems, as depicted in the opinion of the respondents, illustrating in a comprehensive manner the areas where a gap between the significance of a particular Lean Feature, duly supported by the already implemented ISO Quality Management System Standard, and the on ground effective implementation actually occurs. This of course is a very simple and direct method to approach and attack the targeted area as elucidated by the graphical representation, and where the performance is clearly lacking and thus affecting the overall output of typical Public Sector Organizations.

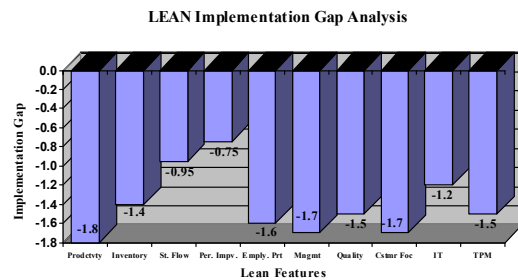

Figure 1. Lean Implementation Gap

From the graphical presentation of the questionnaire response, as shown in the Figure 1, it can be observed that all the Lean Features bear a negative value that reflects a clear cut gap between the importance of that particular feature as per vision and opinions of the respondents and their actual experience regarding an effective implementation of that particular Lean Feature in their respective organizations. An overall Lean Implementation Gap comes out to be **- 1.41**, which proves the existence of a lapse between the goals and objectives pursued by

these Public Sector Organizations under the umbrella of the ISO Quality Management System Standard, and the actual on ground state of affairs.

From Figure 1 the most critical and neglected Lean Manufacturing area turns out to be **Productivity**, which encompasses need for reducing the product cycle time and eliminating the non-value-added activities to bring down the production cost. The implementation gap for **Productivity** comes to **-1.8**, which is greater than the overall Lean Implementation Gap rating of **-1.41**. The second most critical category of Lean Feature is shared by two areas, i.e. **Management**, in terms of its commitment and efforts to produce an environment conducive to fostering Lean Practices, and **Customer Focus**, with respect to focus the customer feedback system and customer satisfaction, both of whom showed lean implementation gap of **-1.7**. **Employee Participation** remains the third most critical Lean Manufacturing Feature with a score of **-1.6**, which is reflective of a lapse or gap of what is emphasized in the Quality Management System Principles under the title of 'involvement of people'. It is significant to mention here that the other Lean Features also fall in the same category of neglect with a very minor difference in scoring and also in negative figure. Not a single Lean Feature has been found to achieve the status of 'rigorously implemented' or otherwise seemed as satisfactory with a positive scoring figure.

4.1. Pareto Analysis

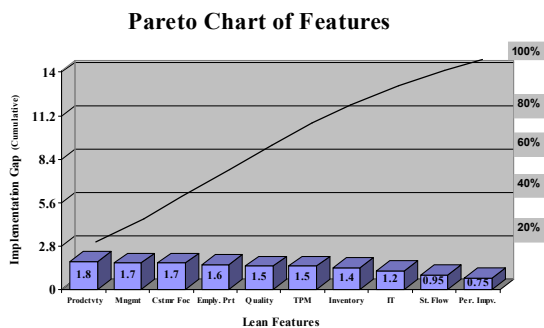

Figure 2. Pareto analysis lean implementation gap

Pareto analysis is an effective tool that can be used to elucidate the vital few factors from trivial many that may be source of the problem. Figure 2 shows Pareto analysis of the Lean implementation gap both in terms of individual lean feature ratings and their cumulative percentage. However, the Pareto analysis fails to establish any major lean features as contributing factor as the cumulative of seven of the ten Lean Features contribute 80% of the aggregate Lean Implementation Gap.

Hence, all ten features are responsible for presence of lean implementation gap in the public sector organizations.

4.2. Service Experience Wise Overall Lean Implementation Gap

A graphical representation of the service wise trend of response towards overall Lean Implementation Gap is shown in Figure 3. The service axis has been divided into three categories according to the experience of the Managerial cadre, such as Assistant Managers & Managers representing the First Line Management, General Managers representing the Middle Management, and Managing Directors and Board Members as Top Management.

Figure 3 reveals that Lean implementation gap exists in the view of all three cadres of service all but with varying degrees of severity. In Top Management's view, the severity level of the problem is of the magnitude of **-1.35** which is closer to the view held by First Line Management scoring at **-1.3** in magnitude. On the contrary, the Middle Management holds a more harsh view of the situation by scoring at **-1.6** of the magnitude. This difference in opinion is explained as the Middle Management, in contrast to the other two tiers of management, face a more tense situation for being responsible of both implementation and compliance to the business policies as dictated by the Top Management, without being given much liberty to influence it, and also to come out with results according to the expectations of the Top Management, despite of the resistance and other valid issues raised by the First Line Management and workforce. Therefore, Middle Management is found keener to eliminate the lean implementation lapses.

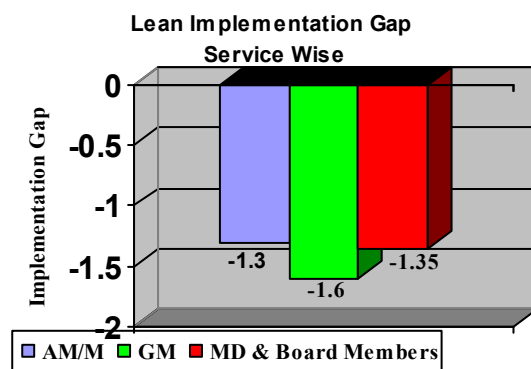

Figure 3. Lean Implementation Service wise

4.3. Priority Lean Features in Individual Service Cadre

Figure 4, 5, and 6 illustrate the individual Lean Features that respective Management level feel have the highest impact on Lean implementation gap and need to be prioritized. This sort of graphical presentation is a great help in analyzing the difference of approaches in viewing the problem at different tiers of Management overall.

The Figure 4 shows that for the Top Management's feels that priority areas are Productivity, Information Technology, and Quality that need to be addressed first to eliminate the Lean Implementation Gap. This is mainly because Top Management is more conscious about the product cost, responsiveness in terms of lead times to meet the commitments and thereby increasing the market share. Information Technology is considered a very important tool that helps in timely decision making and therefore given importance. Quality of product is a chief concern and the illustrated outcome coincides with the achievement of ISO QMS certification which Top Management normally craves.

Figure 5 reveals the general trend of the Middle Management, which seems more and more conscious of and sensitive to Top Management's Commitment to pursue the Lean Manufacturing Process as Business Strategy in their respective organizations. Hence, to divert the attention of the Top Management towards some important issue of Lean Manufacturing and win their commitment on for long term is considered to be the primary achievement. The other two main priorities for Middle Management are employee participation and structured flow in the shape of balanced production lines.

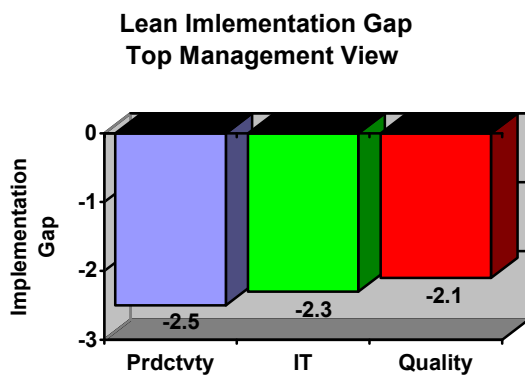

Figure 4. Top Management View, Priority wise

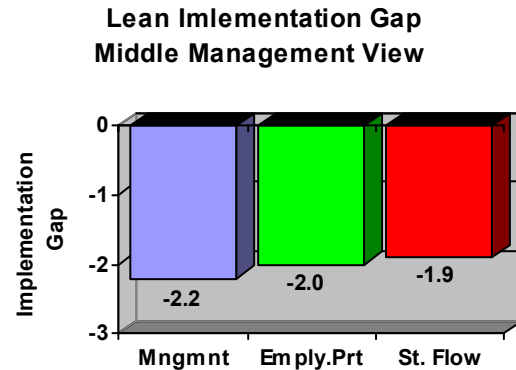

Figure 5. Middle Management View, Priority wise

Figure 6 explains the general trend of the First Line Management in viewing the problem of Lean Implementation Gap by prioritizing Productivity as the main area of concern and focus. This trend can easily be explained as the First Line Managers are normally heavily engaged in daily shop floor level production activities and are more and more sensitive and conscious about the in time completion of production targets.

They envisage production to be directly and severely affected by exaggerated cycle times and other non-value-added activities. First Line Managers are also sensitive to management style and policies that regulate their organizations. This is especially true about the commitment of Top Management in pursuance of a Lean Manufacturing which typically needs drastic and radical steps to be taken within minimum possible time limit. Finally, First Line Managers put the Total Preventive Maintenance on priority since they cannot deliver without an assurance on the behalf of the maintenance department that the plant and machinery involved in the production would remain operational and precise with minimum chance of a surprise breakdown jeopardizing the whole production planning.

Figure 4, 5, and 6 reveal that a problem or deficiency in implementing a Lean Feature is not necessarily prioritized by all the tiers of Management equally. This reflects:

- The presence of Lean implementation gap is all key features of the organization
- The existence of lack of communication among various tiers of Management.

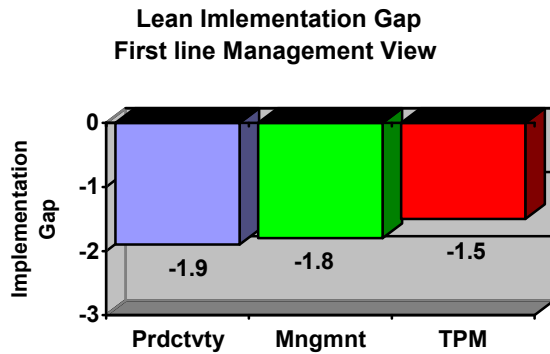

Fig. 6. First Line Management View, Priority wise

5. RECOMMENDATIONS

A thorough analysis of the survey conducted by this study has revealed some very important aspects as discussed in the previous section, and following are the recommendations to address these hitherto neglected areas, especially in the public sector organizations:

- The survey result has arrived at a consensus that Productivity is the area or prime importance to be focused for Business Process Improvement by controlling the product cost through a systematic and periodic review of cycle time and also through the identification and elimination of various non-value-added activities. The typical Public Sector Organizations, owing to their lack of initiative and a culture promoting rigidity and status quo, lags behind in utilizing the concept of 'organizational learning' and hence are suffering a heavy loss.

- The survey report elucidates the lapses present at the end of Management to convey its firm Commitment to pursue Lean Manufacturing as a Business Strategy. The domain of Customer Focus met the same fate. It is pertinent to mention here that both the concepts use to be the primary, most emphasized and most highlighted principles of ISO Quality Management System Standards. The survey reveals both of these areas to be the potential improvement subjects through the implementation of the Best Lean Practices.

- All the managers of the organizations under consideration have unequivocally declared the serious lapses in motivating and empowering the employees in order to win their participation and involvement in the improvement of the business processes and hence being a potential improvement area must be focused for rigorous improvisation.

- The survey report has also been successful in highlighting the communication gap present among the various tiers of management while conceiving

problems the respective organizations are suffering with. The responsibility lies mainly with the Top Management to actively promote and pursue a healthy environment of communication free from fear and rather rewarding for valuable suggestions. This would certainly deplete the communication gap with the organization and would surely keep it from becoming a typical 'stove piped' organization.

- Total Preventive Maintenance coupled with the Cost of Quality has cropped up to be the major area of concern, since a faulty plant and machine not only destroys the quality of the product but also contribute to the cost of quality relying more and more on unnecessary inspection stages as well as in the shape of production of defective parts. The area needs a serious and thorough analysis that how and to what level of investment on the storage and availability of essential spares may guarantee smooth production.

- Somewhat mix response is observed regarding maintaining an appropriate level of Inventory. But, over all, a hoard of various kind of inventories has unanimously been looked upon and considered a hurdle by most of the Managers. But its unnecessary occurrence needs to be addressed on immediate grounds.

- The benefits of IT have been generally been accepted but its haphazard, discontinuous, and fragmented use has highlighted to be the cause of much commotion in the organization. this lapse in the concept of IT as an enabler and its failure in alleviating the load of unnecessary paper work has yet to be addressed.

6. CONCLUSION

This study has basically been conducted to clarify the potential areas of improvement in the production systems of typical Public Sector Organizations that suffer with organizational rigidity and lack of commitment and initiatives for continuous improvement. The study has remained successful in establishing the fact that even in Public Sector Organizations with status of ISO Certified QMS, serious lapses occur in the implementation of Lean Manufacturing Practices in their respective production systems in terms of the elimination of various kinds of wastes and the non-value-added activities. It has also been revealed that there is much in common between the ISO QMS Standards and the LEAN MANUFACTURING SYSTEM, particularly in terms of Leadership Commitment, Employee Participation and Involvement, Quality and Cost of Quality, and Continuous Improvement in the system to eliminate unnecessary activities etc. and in fact both the major approaches can compliment each other in enhancing the over all performance of the organization.

The study has also been successful in illuminating the existence of communication gap and the difference of views among various tiers of management, emphasizing the need that all the working groups should be on the same grid while undertaking a major reformation initiative.

Finally, the study has elaborated in clear terms the need and potential of Business Process Re-design Initiatives and other Business Process Improvement techniques to establish Lean Production environment conducive to a streamlined, waste free production system.

REFERENCES

- 1-Donovan RM, Redesigning Supply Chain Processes for Breakthrough Results, An Executive Briefing from R. Michael Donovan & Co., Inc, 2011. http://2011.fashionnetworks.com/images/article_pdf/Processes1.pdf [Accessed 18/11/2011].
- 2-Executive Development Ltd – Handout Notes for Lean Manufacturing & BPR – revised 2007. www.executive-development.co.uk.
- 3-Gulledge Jr., T. R. and Sommer, R. A. (2002). Business process management: public sector implications, in *Business Process Management Journal* vol. 8 No. 4, pp. 364-376.
- 4-Hammer, M. and J. Champy. *Reengineering the Corporation: A Manifesto for Business Revolution*, Harper Business Press, New York, USA. 1993.
- 5-Harmon P. Lean, Process Redesign and BPM, 2011.
- 6-Johnson, G, Scholes K., Whittington, R. Exploring Corporate Strategy, Seventh Edition, Prentice Hall, 2005.
- 7-Kinaxis Corp, A Roadmap to Lean Manufacturing Success, Business Process Trends, vol (9), Number 7, 2011.
- 8-Kay, J. Why Firms Succeed. Oxford: Oxford University Press, 1995.
- 9-McAdam, R, Donaghy J. Business Process Re-Engineering In The Public Sector: A Study Of Staff Perceptions And Critical Success Factors, in *Business Process Management Journal*, Vol.5 No. 1, pages. 33-49, 1999.
- 10-Puglielli R. Lean Versus Quality Management: They Don't Have to Conflict, 2008. <http://www.ptonline.com/articles/lean-versus-quality-management-they-dont-have-to-conflict> [accessed on 21-04-12].
- 11-Robitaille R. Bringing your QMS to the Boardroom, 2004. <http://www.qualitydigest.com/l> approached on 21-04-12 at 22:23.
- 12-Taylor FW. Principles of Scientific Management' (1911)
- 13-Thong, J., Yap CS, Seah, KL. Business Process Reengineering in the Public Sector: the case of the Housing Development Board in Singapore" *Journal of Management Information Systems*, 17(1), pages 245-271, 2000.
- 14-Westgard S. Quality Management Cocktail ISO, Lean, And Six Sigma, 2005. [accessed on 21-04-12].
- 15-Zaheer A, Mushtaq K. Reengineering the Procurement Process in a Public Sector Organization: A Case Study, International Bulletin of Business Administration, EuroJournals Inc, 2008. http://www.eurojournals.com/IBBA_3_04.pdf [Accessed 15/12/2011].

5/12/2012

The Role Of Data Protection Technologies: A Case Study

Shafqat Hameed*, Mujtaba Hassan Agha**, Muhammad Abbas Choudhary***

*, National University of Sciences & Technology (NUST), Islamabad, Pakistan

** Department of Mechanical Engineering, Mohammad Ali Jinnah University, Islamabad, Pakistan

***University of Engineering and Technology (UET), Taxila, Pakistan

Shafqat.hameed@ceme.nust.edu.pk

ABSTRACT: In today's digital era, Consumers information plays a very significant role for the companies. They are utilizing this information in different ways to cater the costumers with novel products and services. But the privacy of this information is of much more importance for the service providers as well as for the consumers. The privacy and the protection of the Customers' personal information is a growing concern for the consumers of the telecommunication services all over the world. The importance of telecommunications is apparent from the revenue this service generates for the world economy. There have been innumerable cases around the globe which demonstrated lack of security of customers' personal data. The causes might be different apart from lack of investment in the sophisticated technology for this growing concern. The aim of this study is to analyse the privacy policy of the telecommunication companies, the laws related to customer data protection, different incidents related to customer's privacy and the role of different data protection technologies to overcome this soaring issue.

[Shafqat Hameed, Mujtaba Hassan Agha, Muhammad Abbas Choudhary. **The Role Of Data Protection Technologies: A Case Study.** *Life Sci J* 2012;9(4):1270-1279] (ISSN:1097-8135). <http://www.lifesciencesite.com>. 192

Key words: Telecommunications, privacy, data, information, protection, technology

1. INTRODUCTION

The mobile telecommunications sector is growing at a large scale in Pakistan. Telecommunications is not only one of the fastest growing sectors in Pakistan but also all around the world. It plays a significant role in global economy. Pakistan was the third fastest growing telecommunications market in the world in 2008 (Wilson J, 2009) and it is estimated that in April 2011 it has 108 million mobile subscribers (CIA, 2011). In Pakistan, cell phone coverage has been provided to approximately 90 percent of the areas and more than half of Pakistan's population has access to a cell phone.

With the evolution of technology, the privacy has been the most important issue for the customers associated with information technology. The aim of this study is to identify the significance of the customers' privacy and their data protection and how the technology can be used to improve the privacy and to protect the customers' data?

Every country possesses written laws for the protection of personal information and the limits under which the private information can be accessed or used are provided by the concerned authorities. Consumer privacy has become a crucial issue with the advent and evolution of the mass communications, electronic methods, telecommunications and Web. In telecommunications, Personal information includes call traffic details, service usage data i.e. email/internet and customer information which includes

name, address, fixed line number, mobile number, email address and all other contact details. And when personal information of costumers is misused or deficiently protected, its consequences can be identity theft, financial fraud, and other problems that collectively cost people, businesses, and governments millions of dollars per year. In the telecommunications sector, lack of privacy and data protection is a perturbing situation for the consumers which need to be addressed. The main objective of all the businesses, by and large, is to satisfy the customers at an optimum level.

"Data privacy refers to the evolving relationship between technology and the legal right to, or public expectation of privacy in the collection and sharing of data about one's self. Privacy concerns exist wherever uniquely identifiable data relating to a person or persons are collected and stored, in digital form or otherwise"(Jericho Forum, 2007).

In addition, early definitions of consumer privacy concentrate on two types of control: 1) control of presence of others in the marketing environment and 2) control of transactional information (Goodwin 1991; Jones 1991). These definitions of privacy were elaborated to include the information regarding the consumers' knowledge about the organization's information practices and privacy policy (Foxman and Kilcoyne 1993; Nowak and Phelps 1995). Consumers assert that they have a right to privacy in marketing situations, But consumer privacy is not considered absolute for the following reasons: 1) Conflicts of

consumer privacy with other consumer and marketer rights, 2) what represents consumer privacy is culturally, and individually determined 3) Moreover, who “owns” consumers’ private information, the terminology differs in marketers and consumers (Foxman and Kilcoyne 1993; Milne and Gordon 1993). Similarly, The literature inquired the ethical dimensions of consumers’ right to privacy and marketers’ information practices. Researchers have examined the different associated justifications of regarding control of information, the privacy trade-offs that customers make with a firm and the application of several theories to explain perceptions of authority, trust, and equity regarding a firm’s information practices.

It is legitimate for the consumers to question the companies about their concerns related to the services and the obligation of the service providers is to address their concerns. Data Protection and Privacy is a challenging problem for the telecommunication companies. It is not easy to manage and handle the large data of billions and trillions terabytes and even more. Undoubtedly, Technology has solved myriad problems and it will continue to do so in future. It is evolving day by day as the solution of numerous problems which are encountered daily. Technology is also trying to provide solution for this issue of privacy and data protection. In this paper we will analyse in detail the role of different data protection technologies and privacy enhancing techniques to address this surging issue.

2. Literature review:

2.1. Concept of Privacy in Telecommunications

The concept of privacy in telecommunications is not different from the concept of privacy in other spheres of life. Although, there is confusion regarding the interpretation of word Privacy, yet in literature this word has been defined in detail. (Rodríguez, 1997) defined the term privacy in four levels.

2.1.1. Descriptive level

In the descriptive sense privacy does not relate to explicit legal or moral connotation. This refers to the most primitive opinion of privacy. The versions available in dictionaries are said to be of descriptive level. Which are based on two concepts, one is the concept of seclusion which is known as a “zero relationship”, and the other one is the concept of secrecy.

2.1.2. Value level

In a value sense, it is the individual who decides which aspects of his life he believes should not be shown to public eye. Moreover, the entire society should also form an opinion that to what extent the individual’s privacy should be respected, and what is the socially acceptable scope of privacy.

2.1.3 Legal level

In a strictly legal sense, the term privacy refers to the special sphere of privacy protected by law. Privacy also refers to the right to privacy in the strict sense.

2.1.4 Interest level

Sometimes the term privacy is often used to refer not to the right itself, but to the interests justifying the protection granted to some right.

The role of the interests is played by privacy that lay behind the protection of other corroborative rights e.g. the secrecy of telecommunications

Generally, privacy is defined as “the control over one’s seclusion and secrecy. In telecommunications privacy this definition can justify the recognition of the secrecy as a right, one’s freedom of action which is one’s freedom to express oneself freely in telecommunication as a medium of communication that is the utmost reason for the protection of secrecy in telecommunication industry (Rodríguez, 1997).

2.2. Privacy protection approaches

Quinn (2005) divided the approaches to privacy into two categories:

2.2.1. Free market approach

In this approach, the Commercial entities can do whatever they want but with the expectation that customers will choose to do business with those corporations which respect consumer privacy to an appropriate degree. And if few companies do not sufficiently respect privacy, then they would ultimately lose market share. This approach may be confined by limited competition of enterprises in a market, who are not offering favourable privacy options to the user, or the deficiency on the user’s part regarding the information about actual privacy practices. Moreover, the claims made by the organizations about the privacy protection may be hard for consumers to affirm.

2.2.2. Consumer protection approach

In consumer protection approach, it is recognized that customers may have lack of time or knowledge to make any informed choices, or lack of reasonable alternatives available (Jensen and Pots, 2004) Mostly average person cannot comprehend the privacy policies and this approach justifies government definition of privacy and privacy standards.

2.3. Privacy in location based services

Problems associated with customer’s privacy are increasing for location tracking capabilities of mobile devices are increasing; customers’ perspective and preferences comprise personal information and unlawful usage that breaches user’s privacy. Various methods have been suggested to protect user’s privacy when using location based services which includes the methods of anonymizing servers, encryption of information blurring etc. Several methods for privacy quantification have also been proposed, for calculating

the balance between the advantage of providing precise location data and the disadvantages of personal privacy risking (Voulodimos and Patrikakis, 2009). Furthermore, Customers of such services can be allowed to choose to display more generic location information e.g. "In the City" or "Islamabad" or "Work" to whom they want to inform by displaying only selected information in location, like their exact address, to Family members and close friends.

2.4. Data Protection

(Clark, 2008) defines data protection as an umbrella term which blankets a broad range of technologies for safeguarding data assets. Data yielded and controlled by upper-layer applications is the raw material of useful information. Loss of data is directly proportional to loss of revenue, the consequence of which is ultimately the loss of the enterprise itself (Clark, 2008).

Because data is very crucial for the viability of a firm, detecting the ways to restrict access to data and ascertain the integrity of the data is fundamental to an IT strategy. Data is ultimately stored on any form of storage media which includes solid state disk, optical media, and tape and in disk media in the form of storage arrays. Some examples include Network attached storage which processes files to upper-layer applications, but it is unable to do reliably without underlying safeguards at the block level, also includes redundant array of inexpensive disks (RAID), alternate pathing, data replication, and block-based tape backup (Clark, 2008).

2.5. Customers' Data to be protected in Telecommunications

(Nut, A. 2008) It is vital for the success business to secure the data and information of the companies and customers. In the present world where identity theft is at rise small firms are regrettably not prepared to handle the responsibility of the data security.

Some small businesses realize the significance of provision of secure storage for their customers' data. They have observed the consequences of improper storage of data. When customers get to know about the loss of their personal information, customers begin to think twice about doing business with that company (Nut, A. 2008).

2.5.1 Kind of data to be protected

Data Protection Commissioner Ireland (2008) has defined the kinds of data to be protected in telecommunications to be as follows:

2.5.1.1 Detailed telephone record retention

Detailed records of customer's telephone calls may be kept for the required period to settle bills and payments but no longer than that. But few companies

may require retaining personal details for a longer time.

2.5.1.2. Storing and accessing information on terminal equipment i.e. "Cookies"

Information can only be stored on or retrieved from a user's computer or any terminal equipment after the individual allows this. Moreover, it is the right of individual to refuse the placing or accessing of this information.

2.5.1.3. Calling Line Identification

It is lawful for telecommunication users to hide their contact number, which is invisible to other user. It is not necessary for the users who make marketing calls to hide their phone number when making these calls.

2.5.1.4. Location Data

If the individual allows the processing of location or other traffic data then it may be accessed for providing the value added service to the customer.

2.5.1.5. Public Telephone Directories

Public telephone directories also provide the user's personal information. The Individuals have the right to exclude themselves from the directory for protecting their privacy.

2.5.2. Customer

If the personal details of the customers are obtained for product marketing then web-mail and SMS marketing are only allowed to take place if a service is user friendly and an opportunity is given to object to these marketing messages.

2.5.3. Consent

For sending the marketing messages the consent of the individual is required if the person is not the customer. E.g. the individual must be asked that if he wishes to receive marketing material.

2.6. Privacy Policy of Telecommunication companies in Pakistan

Every telecommunication company provides its customers with privacy policy. Through the privacy policies the company describes the details to the customer that how the company will use the customer's personal information. To whom the company discloses the customer's personal information and the reasons for the disclosure are provide. Following are the privacy policies of the few telecommunication companies in Pakistan.

2.6.1. Ufone GSM

2.6.1.1. Personal Information

The information or data that identifies the customer is a Personal Information. Ufone presumes that the

personal information provide to them is true, accurate in complete is all respects. The personal data with Ufone includes customers' name, their birth date, their addresses, their telephone numbers, emails, credit card and their bank account details, occupation, details of references, PIN and passwords of Ufone account (Ufone, 2012).

2.6.1.2. Use of Personal Information

Ufone informs the customers that their personal information may be used for:

- Affirming customer's personal identity
- Aiding customer to subscribe to ufone's services.
- Provision of the services which customers require
- Managing the services like charging, billing and collecting debts.
- Conducting suitable checks for credit worthiness
- Understanding the needs of customers' information and communication to provide them with a better and improved service.
- The Promotion and marketing of Ufone services for the benefit of customer.

Ufone pledges that it does not disclose customer's personal information third parties e.g. other cellular service providers, banks and credit card companies and their agents which can ultimately lead to invasion to customer's privacy. In contrast, company may affiliate with such agencies for the benefit of the customers to provide them with better services. And the company may reveal customers' personal data to these agencies for marketing or any other purposes. Ufone aims to ensure that these organizations are obliged to and will protect customers' personal data and information. Furthermore, Ufone may disclose customers' personal information to:

- Authorized representatives of customers'
- The agencies like Credit- reporting and fraud-checking agencies
- The companies related to Ufone.
- Professional advisors, accountants and lawyers etc of Ufone.
- Regulatory authorities and Other Government organizations authorized by law.
- And those firms which manage Ufone's business and corporate strategies.

Moreover, Ufone may also reveal customers' personal data for good if it considers its necessity as a legal requirement to protect and defend the rights and interests of its customers (Ufone, 2012).

2.6.1.3. Information Security

Ufone desires employees and contractors to perform their duties with responsibility in such a way that is coherent with Ufone's legal responsibilities regarding customer privacy. Ufone is committed to respect the privacy of the customers' on a priority basis and ensures that this personal information will not be disclosed to any outside Organizations other than those organizations working on behalf of Ufone (Ufone, 2012).

2.6.2. Warid Telecom

Warid shows its commitment to respect customers' privacy and to abiding by the applicable data protection and privacy laws (Warid, 2012).

2.6.2.1. Personal Information Collection

Warid pledges to collect and use customers' personal information only with their knowledge and consent. The personal information which Warid collects includes their name, address, birth date, gender, telephone and fax numbers, email address, and credit/debit card information. The personal information collected would be used only for providing the particular service to the customer. (Warid, 2012).

2.6.2.2. Usage of Personal Information

Warid uses customers' information for various purposes which include: Customers' order processing, management of their account; for delivery of service, for responding to complaints or account enquiries; administering debt recoveries; verification of their identity when required for example; to help the customers for data protection if they lose their password or PIN information (Warid, 2012).

2.6.2.3. Disclosure of Information

The customers information may be disclosed by Warid, to the companies designated as 'Warid Affiliates'; and in case that Warid experiences re-organization or sold to a third party, in this case customers agree that any personal information we hold about them may be transferred to that re-organized entity or third party for the purposes.

Moreover, Warid does not sell or pass your personal information to third parties without the consent of customers. The customer data can be revealed for the validation of credit card details or to obtain payment for billing

Warid can reveal customer's data to comply with the legal requirement (Warid, 2012).

2.6.2.4. Information Security

Warid is aware of the customers' increasing concern about the protection of their personal information and how they protect their data from

misuse. Warid is continuously reviewing and enhancing its procedures which include technical, physical and managerial procedures for the protection of customer's personal data from unauthorized access, accidental loss or destruction. The technology used by Warid for data protection is secure sockets layer (SSL) technology, which helps to encrypt sensitive information such as customers' finance related information (Warid, 2012).

The communications on the Internet are not secure until they are encrypted as the data may route through different mediums and links before delivery. Warid is not responsible for loss of personal information which is beyond its control (Warid, 2012).

2.6.2.5. Monitoring and recording of customer's communications

Prevention of crime is essential for any country. The law permits the Monitoring or recording of customer's calls, emails, text messages and other communications for the security objectives (Warid, 2012).

2.6.3. Telenor

The privacy policy of telenor also describes all of the above mentioned points. (Telenor, 2012).

2.7. Data Protection Technologies

Several telecommunication companies have used data protection technologies and privacy enhancing techniques to increase the efficiency of organization to protect the customers' private data. Moreover, Data protection solutions and technologies can be categorized by the scope of defense they provide. Protection against component, link, or device failure is provided by lower level solutions; while protection against system, business application, or site failure is provided by higher level solution, as shown in Table 1.

Table 1. Data Protection Mechanisms (Clark, 2008)

Type of Data Protection	Protection against	Recovery time objective	Recovery point objective
RAID	Disk drive Failure	Instantaneous	No data loss
Mirroring	Link, disk or array failure	Instantaneous	No data loss
True CDP	Data corruption	Seconds – minutes	No data loss
Near CDP/Snapshot	Data corruption	Seconds – minutes	Some data loss
Synchronous Replication	System/site Failure	Seconds – minutes	No data loss
Asynchronous Replication	System/site Failure	Seconds – minutes	Some data loss
Disk to disk tape emulation	Array Failure	Minutes	Some data loss
Local Tape Backup	Array Failure	Minutes – hours	Some data loss

2.7.1. Hitachi Data Systems

Telecommunications companies are in a dire need of more storage capacity due to enormous growth rate in this industry. The increasing concern of telecommunication companies is the protection of this bulk of data, which is vital for their business which includes their (BSS) business support data, the content of customer for securing their data.

However, Telecommunication operations demand heterogeneous storage systems because of geographically distributed telecom systems. Therefore, data protection in telecommunications becomes a challenging task because of its distributed nature. The Innovative data protection and management solutions for their telecom customers to help them recover and protect the data along with the data replication and data security offerings are provided by Hitachi Data Systems (Hitachi Data System, 2012).

2.7.1.1 Hitachi data systems solutions for data protection (Benefits)

- One of the benefits is that it protects following data which includes BSS data, customer content like rich media customer content and data centre customer content and it reduces the risk of financial loss with the help of high performance storage infrastructure and automation.
- Another benefit is that it reduces management and training costs and increases IT efficiency having common interface for different operations like backup and recovery, deduplication, continuous data replication, application protection, virtualized backups, remote office protection etc.
- Another benefit is that it replicates critical data disk-to-disk for speedy restore, testing, development and remote disaster recovery protection.
- It helps in making effective use of existing infrastructure and reduces investment in storage with data reduction methods, for instance, deduplication and archiving.
- It helps in improving protection, and recovery of important applications with advanced assessment, design and implementation services (Hitachi Data System, 2012).

2.7.2. Yosemite File Keeper recommended by Safari Telecom

File Keeper's technology protects every document a user edits at the time they save their documents to disk, wherever the documents are stored or the system is disconnected from the network (Safari Telecom, 2010).

2.7.2.1 Challenges

- The individual users manage a wide variety of critical information which is stored on servers, desktop and laptop.
- Laptop computers are unreliable for data protection the reason may be hardware failure and theft, and the result is loss of critical information.
- The users are unable to back up files when disconnected from the network.

2.7.2.2 Solutions

- This technology assists those users who are occasionally-connected by storing changed files on the local disk and then copying them to the file backup locations when users reconnect to their network.
- This technology backs up files as they are created and updated. Reduces the financial effect of data loss by insuring that the updated versions of a user's data are protected.
- The agents of this technology operate in the background and do not require direct interaction with the user. User data is automatically and continuously protected without affecting productivity of the end user.
- Through this technology the users can rapidly and easily restore their own data, which increases their output.

2.7.2.3 Results

- Continuous file protection
- Reduced financial impact as a consequence of data loss.
- The Information stored on the most vulnerable and unreliable equipment in an organization's network is protected.

3. METHODOLOGY

The aim of this study is to measure the extent to which the customers' are concerned about their privacy in the telecommunications. On the whole, approach is descriptive as well as quantitative in nature. Questionnaire tool is used as a base for survey. The questionnaire is prepared to collect data from different groups of people who are customers of different telecommunication companies. It is usually mailed to the informants to be answered. The data is to be used to analyze the effect of privacy protection on the customers.

The questionnaire is created in English. Simple and accurate questions with specific answers were used. The survey questionnaire is comprised of 18 questions and it has been divided into three parts.

- Continuous file protection

- Part one is focused on the customer's general information. It comprises of five questions.
- Part two focuses on the customer's view. This part comprises of eleven questions.
- Part three is comprised of amalgamation of both and the customer views related to solutions to privacy.

The questionnaire is composed of open ended as well as close ended questions. A five point Likert-type scale is used for closed ended questions to measure the degree of concern of customers related to privacy by looking for agreement of the respondents to the survey statements and questions. The respondent is supposed to put up a mark of 1 to a particular question if they strongly agreed to a particular question.

However, if they strongly disagreed they put up a mark of 5 to a given question. For the open ended part of the questionnaire the respondents are supposed to describe their experiences regarding the telecommunications services and their views on privacy.

The questionnaire was made on Google survey and the link was given to different people for giving their views regarding the privacy in their network. 108 questionnaires were filled and the data was collected based on the answers given by the customers of different telecommunication companies.

4. RESULTS AND ANALYSIS

The aim of this research was to identify the extent of privacy needed to the customers in their day to day communications via mobile phone. At present, five mobile telecommunication companies are operating in the country. The data is collected from the customers of different companies and from different cities.

The key questions asked and their results are as follows:

4.1. Which cellular network do you use?

Table 2. Customers of telecommunication companies Data

	Frequency	Percentage	Valid Percentage	Cumulative Percentage
Mobilink	12	11.1	11.1	11.1
Telenor	15	13.9	13.9	25.0
Ufone	54	50.0	50.0	75.0
Warid	21	19.4	19.4	94.4
Zong	6	5.6	5.6	100.0
Total	108	100.0	100.0	

108 customers responded to the questions, out of which Ufone has the maximum number of customers numbering 54 then Warid with 21 customers, Telenor with 15, Mobilink with 12 and Zong having 6 customers in the sample data.

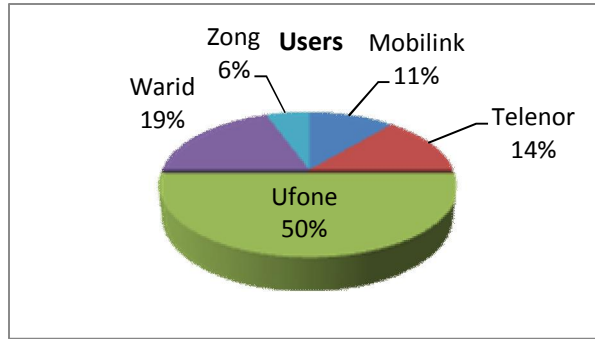

Figure 1. Users of telecommunication companies of Pakistan

According to the data, 50 percent of the customers in the sample are using Ufone, 19 percent Warid, 14 percent Telenor, 11 percent Mobilink and 6 percent Zong.

4.2. Are you satisfied with privacy given to you by your telecom network?

The next question asked was related to the satisfaction level of the customers related to their telecommunication network. Following are the results:

Table 3. Data of customer satisfaction related to privacy protection

Valid	Frequency	Percentage	Valid Percentage	Cumulative Percentage
1	6	5.6	5.6	5.6
2	12	11.1	11.1	16.7
3	54	50.0	50.0	66.7
4	33	30.6	30.6	97.2
5	3	2.8	2.8	100.0
Total	108	100.0	100.0	

Out of 108 customers only three customers (all of Warid telecom) are extremely satisfied with the provision of privacy by the telecommunication companies. Maximum customers (54) are moderately satisfied with the privacy provided by the companies. Six customers are very dissatisfied with the privacy services.

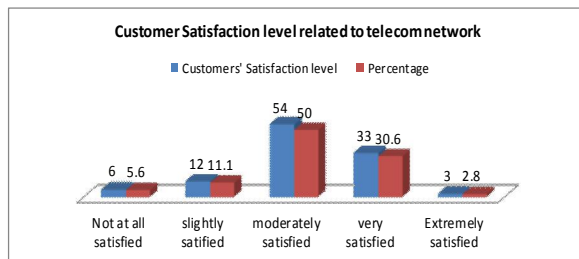

Figure 2. Customer Satisfaction Level

4.3. I am satisfied with the privacy of the voice data of my network given to me?

The next question was related to the privacy of voice data provided to the customers. For instance, the call records of the customers, the talk time of the customers etc. Following are the results which are based on the sampling and research.

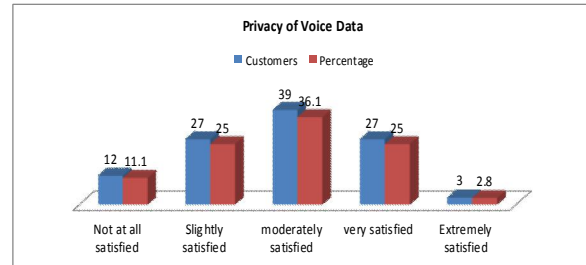

Figure 3. Privacy of Voice data in Telecommunication companies

36.1 percent of the customers are moderately satisfied with the privacy of the voice data provided by the telecommunication companies. 25 percent are slightly satisfied and rest of the 25 percent are also satisfied with the privacy. Furthermore, 11.1 percent of the customers are not at all satisfied with the privacy. 2.8 percent are extremely satisfied with the privacy of the voice data given to the customers.

4.4. I should know at what time cellular company is monitoring my SMS, MMS in the mobile.

Another question that was asked from the customers was on their concern regarding the monitoring (by the service provider) data which is textual form or in the form of pictures and videos. Following are the results.

Table 4. Data privacy of SMS/ MMS according to the customers

Valid	Frequency	Percentage	Valid Percentage	Cumulative Percentage
1	6	5.6	5.6	5.6
2	3	2.8	2.8	8.3
3	18	16.7	16.7	25.0
4	81	75.0	75.0	100.0
5	0	-	-	-
Total	108	100.0	100.0	

75 percent of the customers strongly agree with the statement that they should know when and why their data is being monitored. 16.7 percent remained undecided about this matter. 2 percent disagreed with the statement whereas 5.6 percent of the population of sample strongly disagreed that they should not be provided with the information about the monitoring of their SMS and MMS data.

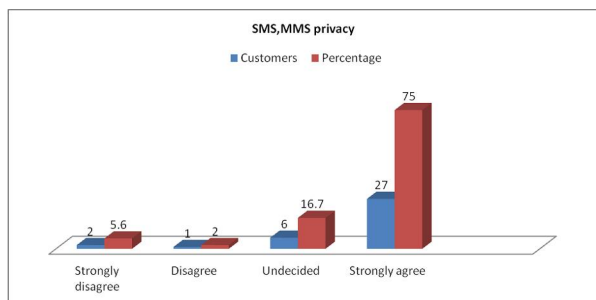

Figure 4. Customer views on SMS and MMS privacy

4.5. I should know at what time my voice is being recorded by some other person?

Next sequential question was based on the monitoring and recording of the customers' voice. Following are the results and the data collected from the customer'.

Table 5. Data of voice monitoring and recording

Valid	Frequency	Percentage	Valid Percentage	Cumulative Percentage
1	0	-	-	-
2	9	8.3	8.3	8.3
3	3	2.8	2.8	11.1
4	15	13.9	13.9	25.0
5	81	75.0	75.0	100.0
Total	108	100.0	100.0	

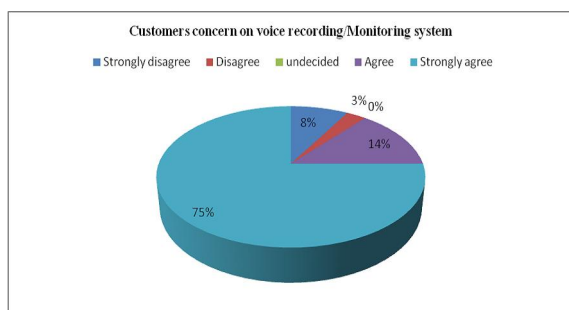

Figure 5. User concerns on Voice Data Recording

75 percent of the sample population strongly agreed with the statement that they should know when their voice data is being monitored/ recorded by third party. 14 percent agree with the statement, 3 percent disagree and there was no disagreement with the strategy of disclosing the information about the timing of the voice recording data.

4.6. Are you satisfied with the customer service when you feel any complain of privacy?

The next question that was asked in the questionnaire was based on the customer services that were given by the company to the customers that whether they are beneficial for the customers' related to the privacy matters or not. Following are the results collected from the data.

Table 6. Data of customer services provided by the telecommunication companies

Valid	Frequency	Percentage	Valid Percentage	Cumulative Percentage
1	24	22.2	22.2	22.2
2	24	22.2	22.2	44.4
3	36	33.3	33.3	77.8
4	15	13.9	13.9	91.7
5	9	8.3	8.3	100.0
Total	108	100.0	100.0	

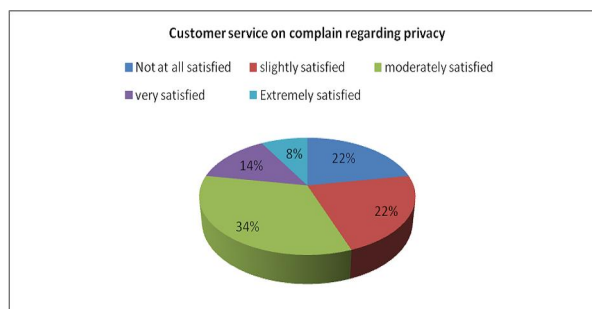

Figure 6: Customers' services on privacy complaints

According to the data collected, 34% of the customers are moderately satisfied by the customers' services provided by the telecommunication companies. 22% are slightly satisfied, 22% are not at all satisfied, 8% extremely satisfied where as 14% are very satisfied with the customer services.

4.7. Have you signed any network privacy agreement before getting the connection?

The next question was based on the privacy agreement that was signed by the customers' when buying the product or services by the telecommunication companies

Table 7. Data of privacy agreement signed by customers

Valid	Frequency	Percentage	Valid Percentage	Cumulative Percentage
Don't Know	42	38.9	38.9	38.9
No	48	44.4	44.4	83.3
No, Don't Know	6	5.6	5.6	88.9
Yes	12	11.1	11.1	100.0
Total	108	100.0	100.0	

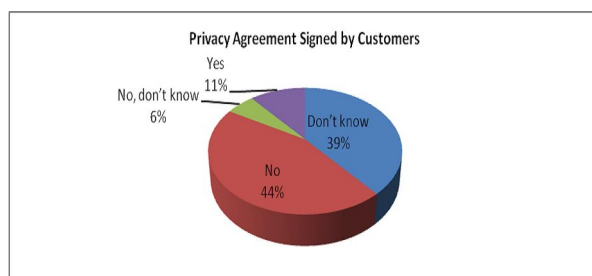

Figure 7: Data on privacy agreements signed by the customers

According to the data collected 44 percent of the customers express that they did not sign any privacy agreement when buying the services. While 39 percent of the customers' don't even know whether they signed the privacy agreement or not, 11 percent agree that they have signed the privacy agreement.

4.7. Is the government efficient in inculcating the privacy of the customer in telecom sector?

Moreover, Customers' were asked about the measures taken by the government in inculcating the privacy as well as making the operations efficient and secure for the customers' privacy. Following are the results of the data collected.

Table 8. Data of measures taken by Government according to customers

Valid	Frequency	Percentage	Valid Percentage	Cumulative Percentage
Don't Know	24	22.2	22.2	22.2
No	72	66.7	66.7	88.9
No, Don't Know	3	2.8	2.8	91.7
Yes	9	8.3	8.3	100.0
Total	108	100.0	100.0	

According to the data collected 72 percent of the customers' say that government is not efficient in inculcating the privacy in the telecommunication sector. 24 percent say that they don't know about the measures taken by the government in order to make the communication secure for the customers.

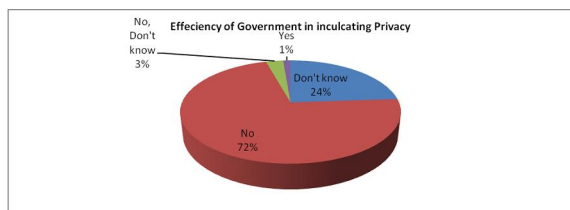

Figure 8. Customer views on measures taken by government in improving the privacy

4.8. Do you feel any role of the technology in giving you the privacy in the network?

The customers were also asked about their views regarding the role of technology in the provision of privacy to the customers. Following are the customers' views regarding the role of technology for the provision of privacy.

Table 9. Data regarding role of technology in enhancing privacy

Valid	Frequency	Percentage	Valid Percentage	Cumulative Percentage
Don't Know	21	19.4	19.4	19.4
No	21	19.4	19.4	38.8
No, Don't Know	0	-	-	38.8
Yes	66	61.1	61.1	100.0
Total	108	100.0	100.0	

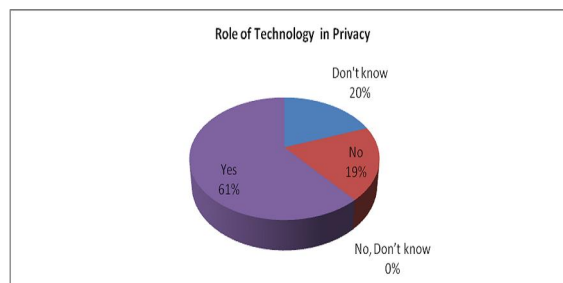

Figure 9. The role of technology in the view of customers

According to the data, 61 percent of the customers' view that there is a role of technology in the provision of privacy in the network, 19 percent say that there is no role of technology in the provision of privacy whereas 20 percent don't know whether there is a role of technology in providing a privacy to the customers or not.

5. CONCLUSION AND RECOMMENDATIONS

Telecommunications is a very important technology which is widely used in Pakistan for different purposes. Therefore, the privacy is crucial for the safe and secure communication. We have collected the data from which it is evident that the customers' are highly concerned about the privacy of their data. They are of the view that the permission should be sought before the usage of their information for various purposes. 63.9 percent of the customers strongly recommend that there should be a proper coded method or data encryption for the transfer of information from one point to another and the third person should not be able to comprehend the language of the data transferred. 97.3 percent of the customers recommend that there is a need of increasing the privacy of the customers. The customers' also recommend that their suggestion should be valued and the choice should be given to the customers and they themselves should choose the level of the privacy they want from the service providers. Moreover, there must be strict controls followed by the company to ensure privacy of the clients. Any person accessing the data should be monitored and no data should be given to any third person without proper documentation in its support. Furthermore, every employee should not have

access to the private information of the customers of the company. This information should only be disclosed to government agencies. The telecommunication companies should keep a vigilant eye over their employees so that they must not disclose the private information of the customers. The customers face different types of problems regarding privacy from different fronts which should be repressed and the higher technology should be considered an only mean through which the privacy of the customer data could be enhanced and protected.

REFERENCES

- 1-Jericho Forum. Position Paper Principles for Managing Data Privacy, May 2007.
- 2-Clinton D. Lanier & Saini A. "Understanding Consumer Privacy: A Review and Future Directions", Academy of Marketing Science Review, Volume 12, Article no. 2, 2008.
- 3-Wilson, J. Telecom Regulatory and Policy Environment in Pakistan: Results and Analysis of the 2008 TRE Survey, LIRNEasia, 22 January 2009.
- 4-Rodríguez, B. Privacy in telecommunications: a European and an American approach, Kluwer Law International, 1997.
- 5-Quinn, Michael J. Ethics for the Information Age, Second Edition, Addison Wesley, 2005.
- 6-Jensen, C & Pots, C. Privacy policies as decision-making tools: an evaluation of online privacy notices, Proceedings of SIGCHI conference on Human factors in computing systems (CHI'04), April 2004, Pages 471-478.
- 7-Voulodimos A.S. & Patrikakis C.Z., Quantifying Privacy in Terms of Entropy for Context Aware Services, Special issue of the Identity in the Information Society journal, "Identity Management in Grid and SOA", Springer, vol. 2, no 2, December 2009.
- 8-Clark, T. "Strategies for data protection: A strategic approach to comprehensive data protection", First Edition, Brocade, 2008.
- 9-Nut A. (2008) "The importance of data security" Data protection Commissioner Ireland, Data Protection in the Telecommunications sector. <http://www.dataprotection.ie/viewdoc.asp?DocID=906>.
- 10-Ufone GSM Pakistan, "Privacy Policy" <http://www.ufone.com/privacy.aspx>.
- 11-Warid Telecom Pakistan, "Privacy Policy". http://www.waridtel.com/privacy_policy.php
- 12-Telenor Pakistan, "Privacy Policy". www.telenor.com.pk/privacy-policy.
- 13-Hitachi data systems "Hitachi-solution-profile-data-protection-management-telecom" <http://www.hds.com/assets/pdf/hitachi-data-systems-solutions-for-data-protection.pdf>.
- 15-Safari Telecom, "Safari-telecom-recommends-yosemite-filekeeper-simple-yet-effective-data-protection".
- 16-CIA (June 2011) "Pakistan Country Report"; "The World Fact book".

5/12/2012

Prevalence of Vaginal Candidiasis infection in women referred to Kermanshah hygienic centers, Iran in 2010Reza Faraji¹, Mehr Ali Rahimi^{1,2*}, Mojdeh Assarehzadegan³¹. Diabetes Research Center, Kermanshah University of Medical Sciences, Kermanshah, Iran.². Department of Endocrinology, Medical School, Kermanshah University of Medical Sciences, Kermanshah, Iran.³. MD, Mohamad Kermanshahi Hospital, Kermanshah, Iran.Corresponding email: mjavadra@yahoo.com

Abstract: Vulvovaginal Candidiasis is a female genital system infection that occurs due to *Candida* species. Candida infection in the vagina can cause a smelly, thick, white – yellow discharge that might be accompanied by itching, irritation and swelling. It can also can make walking, urinating or sex very painful. The aim of this study is determining the prevalence rate of vaginal candidiasis infection in women referred to Kermanshah hygienic centers, Iran in 2010. This descriptive – analytic study was performed on 105 women referred to Kermanshah hygienic centers, Iran in 2010. All specimens were examined under direct microscopy and cultured on Sabouraud Dextrose Agar (SDA). Complimentary tests such as germ tube test and sugar assimilation test (API) were carried out to differentiate the *Candida* species. Statistical analysis was performed using the Chi-square test. Of 105 samples under experimnet, 10 cases (9%) in direct microscopy test and 30 cases (29%) by cultivation on Sabouraud Dextrose Agar were infected to vaginal candidiasis. The frequencies of the isolated *Candida* species include *C.albicans* with 28 cases (70%), *C.glabrata* with 5 cases (12.5%), *C.kruzi* with 3 case (7.5%), *C.tropicalis* with 2 cases (5%) and *C.parapsilosis* with 2 cases (5%). *C. albicans* was, by far, the most predominant yeast isolate. The culture of vaginal discharge should be warranted because the culture technique is more sensitive than direct smear.

[Faraji R, Rahimi MA, Assarehzadegan M. **Prevalence of Vaginal Candidiasis infection in women referred to Kermanshah hygienic centers, Iran in 2010.** *Life Sci J* 2012;9(4):1280-1283] (ISSN:1097-8135).
<http://www.lifesciencesite.com>. 193

Keywords: Vaginal candidiasis, women, Iran.

Introduction

Vaginitis is the most common gynecological problem in women. The three infections most commonly associated with vaginal discharge are bacterial vaginosis (BV), vulvovaginal candidiasis (VVC) and trichomoniasis (1,2). Vulvovaginal candidiasis is the second most frequent infection after Bacterial vaginosis. Up to 75% of all women will experience fungal vulvovaginitis at some point in the lives, and approximately 40-50% will experience a second episode of this disease (3-5). *Candida* infection in the vagina can cause a smelly, thick, white – yellow discharge that might be accompanied by itching, irritation and swelling. It can also can make walking, urinating or sex very painful (6). Since the symptoms of vaginal candidosis are not specific to the infection, diagnosis cannot be made solely on the basis of history and physical examination. But the clinical diagnosis of vaginal candidiasis should always be confirmed by laboratory diagnosis. Unfortunately, up to 50% of patients with culture positive symptomatic vaginal candidosis will have negative microscopy. Thus, although routine cultures are not necessary if microscopy is positive, vaginal culture should be done in symptomatic women with negative microscopy (7). Common risk factors for vaginal candidiasis are recent antibiotic use, pregnancy, diabetesmellitus, oral-contraceptives

and inadequate therapy (8). Among women with acute vulvovaginal candidiasis, *Candida albicans* accounts for 80–90% of the isolated fungal species, whereas other species are less frequent. Nevertheless, in recent years a significant increase in infections caused by non-*albicans* species of *Candida* has been suggested (3,8-10). The aim of this study is determining the prevalence rate of vaginal candidiasis infection in women referred to Kermanshah hygienic centers, Iran in 2010.

Materials and Methods

This descriptive – analytic study was performed on 105 women referred to Kermanshah hygienic centers, Iran in 2010. We administered a questionnaire to obtain information about: age, occupation, education, symptoms, contraception, marital status and diabetes mellitus. Two sterile cotton-tipped swabs were used to collect discharge from high vagina and sent to the laboratory without delay. One of the two swabs was used to determine the presence of yeast by methyleneblue staining in direct microscopy, while the other was used for fungal culture (culture on sabouraud's dextrose agar supplemented with 50 mg chloramphenicol). The diagnosis of VVC were based pseudo-hyphae identified by microscopic examination and whom *candida* grew on high vaginal swab culture. Isolated

strains were identified using the germ tube test and API system 20C AUX (Biomérieux, France) (11,12). Statistical analysis was performed using the Chi-square test and a p-value <0/05 was considered as significant.

Results

105 women referred to Kermanshah hygienic centers, Iran in 2010 were eligible for this study.

All women age was 18-55 years (9 ± 36). 81% of the women had irritation, 74% had itching and 87% had discharge were in relation with VVC. The above symptoms were seen in the most of the women and the symptoms of other cases were not relevant to VVC. Regarding the educational level 86% of women were illiterate and high school, and 14% were college educated. 81% of women were housewives, and the rest were working women. 50% of women have used of contraception devices such as: Intrauterine device (IUD), Hormonal and condom. 80% of women were married and 20% were single. 70% of women had diabetes mellitus. The prevalence rate of vaginal candidiasis infection according direct test and Mixture Culture reported sequently 9% and 29% (Figure 1,2,3). Species of *candida* isolated in this patients consist of: *C. albicans* with 28 cases (70%), *C. glabrata* with 5 cases (12.5%), *C. Kruzi* with 3 case (7.5%), *C. tropicalis* with 2 cases (5%), and *C. parapsilosis* with 2 cases (5%) that *C. albicans* was, by far, the predominant yeast isolate (Table1). In the present study we found a significant statistical difference between vulvovaginal candidiasis and age, education, symptoms, contraception, marital status, and diabetes mellitus, But we did not find a significant statistical difference between vulvovaginal candidiasis and occupation (Table 2).

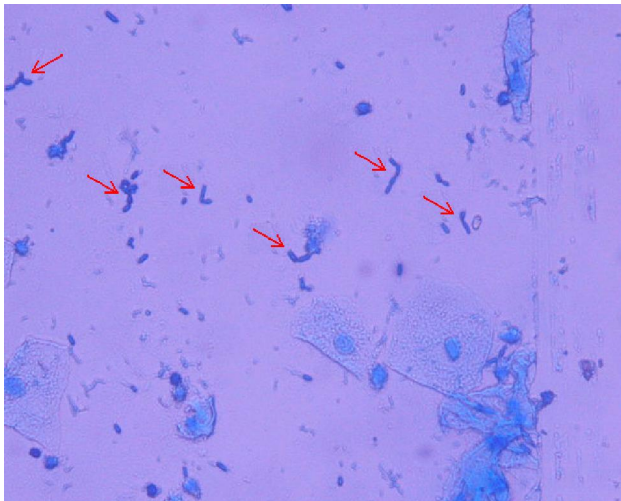

Figure 1. Pseudohyphae identified on microscopic test



Figure 2. The growth of cells *candida* on Sabouroud Dextrose Agar

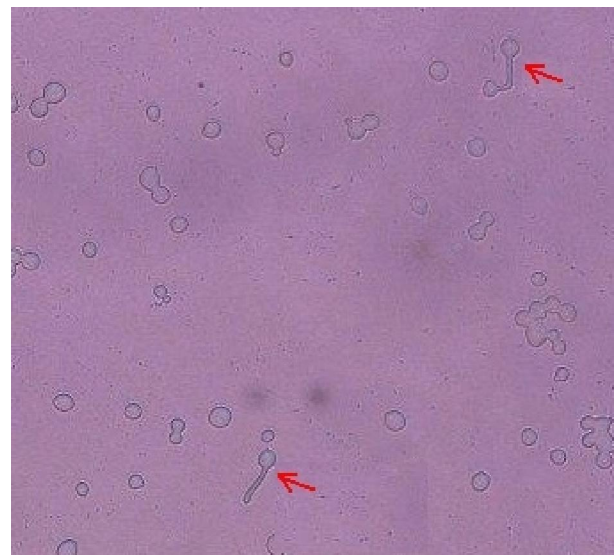

Figure 3. Germ tube identified on microscopic test

Discussions

Vaginitis is one of the most common conditions for which women seek medical care in many parts of the world. It is usually characterized by a vaginal discharge or vulvar itching and irritation. It is usually characterized by a vaginal discharge or vulvar itching and irritation (2,13). Nowadays vaginal yeast infection is usually diagnosed on the basis of clinical symptoms, direct microscopic examination and vaginal culture. The microscopic examination of the clinical material is rapidly performed and may identify the presumptive etiologic agent, but vaginal culture is indispensable to confirm the diagnosis (8,14).

Table 1. Frequency of different *Candida* species isolated from women referred to Kermanshah hygienic centers, Iran in 2010.

<i>Candida</i> species	Positive cases	Percentage (%)
<i>C. albicans</i>	28	70
<i>C. glabrata</i>	5	12.5
<i>C. krusei</i>	3	7.5
<i>C. tropicalis</i>	2	5
<i>C. parapsilosis</i>	2	5
Total	40	100

Table 2. Predisposing factors for infection in women referred to Kermanshah hygienic centers, Iran in 2010.

Predisposing factors	positive cases (n)	Percentage (%)	Pvalue
Age			
≤ 40 years	22	73	0.041
> 40 years	8	27	
Occupation			0.313
Working	14	47	
Housewife	16	53	
Education			0.0005
College	11	37	
illiterate, high school	19	63	
Symptoms			0.001
irritation	85	81	
itching	78	74	
discharge	91	78	
Contraception			0.033
Yes	18	60	
No	12	40	
Marital status			0.032
Married	24	80	
Single	6	20	
Diabetes mellitus			0.005
Yes	20	67	
No	10	33	

Qinghai, et al. found only 1 cases (0.3%) pseudohypha by microscopic examination. Grigoriou, et al. strongly believed that diagnosis must be made thorough vaginal cultures. In our study, on the basis of microscopic examination and the vaginal discharge culture we had 9% and 29% prevalence rate, respectively. Based on this study and also similar studies, it could be said the discharge culture is more sensitive than the direct microscopy test. In this study as the other studies (8,15-18) the most separated species from the patients was *C. albicans*. The first step in establishing a yeast infection is bonding to the vaginal mucosa. It seems that *C.*

albicans is more adhesive than other non-*C. albicans* species. This could be considered as one of the likely reasons that this species are predominant rather than non-*C. albicans* species (8,17). But unlike other studies on the prevalence of non-*C. albicans* species as increasing species (12,19-21) a high rate of prevalence of non-*C. albicans* species was not achieved in our study. In this study most of the women with vaginal candidiasis infection were mainly categorized into an age ≤ 40 years. That maybe the reason is the activeness of the age of this group from the women of view of sexual, vaginal increase secretions, and the high amount of signed infection at the reproductive ages. We found a significant statistical difference between positive vaginal *Candida* culture and Marital status. That factors such as genital hygiene, menstrual cycle, and contraception are substantial. Also we found a significant statistical difference between vaginal candidiasis and contraception method, so that women who had used of hormonal contraception, IUD, and Condom were 60%, that can be related to low doses of hormones, vaginal increase secretions and the acidity of the PH of vaginal by IUD, and the sensitivity of vaginal epithelial cells to Condom. A significant statistical difference between vaginal candidiasis infection and education was found in this study, which could be attributed to the observance of genital hygiene and recognize the risk factors of cause diseases. The symptoms often include burning, itching and discharge which have been proved by many relevant studies.18 In the present study, also we found a significant statistical difference between positive vaginal *Candida* culture and symptoms. In addition Peer, et al. showed that 25.4% of infected women with vaginal candidiasis infection did not present any clinical symptom. It can be concluded from the above points that vaginal candidiasis infection is not always accompanied by sever detectable symptoms and sometimes it does not demonstrate any symptom and sometimes it shows very mild symptoms. Different studies indicated that vulvovaginal candidiasis infection is more common in women with diabetes than in the normal population. The prevalence rate ranged from around 7% to more than 50% (6,22,23) Similar to the study by Malazy, et al. we found a significant statistical difference between positive vaginal *Candida* culture and diabetes mellitus. Bohanon, stated that the main causes of this state of affairs is hyperglycemia. Increased glucose levels in genital tissues enhance yeast adhesion and growth. Vaginal epithelial cells bind to *Candida* with greater propensity in diabetic women than in non-diabetic women. Furthermore diabetes mellitus plays an important role in prevalence vaginal *Candida* infection.

Conclusion

The present study involved only 105 women. There is need to perform similar study in large number and for a longer duration. But according to the results in this study *C. albicans* was, by far, the most predominant yeast isolate. Also The culture of vaginal discharge should be warranted because culture technique is more sensitive than direct smear.

Acknowledgements

The authors sincerely appreciate the Kermanshah hygienic centers, Iran and Dr. Ali Mikaili of the Department of Medical Mycology, Medical School, Kermanshah University of Medical Sciences, Kermanshah, Iran.

References

- 1- Owen MK, Clenney TL. Management of vaginitis. *Am Fam Physician* 2004; 70: 2125-32.
- 2- Qingkai DA, Lina HU, Yongmei JI, Hua SH, Jinho LI, Wenjie ZH, et al. An epidemiological survey of bacterial vaginosis, vulvovaginal candidiasis and trichomoniasis in the Tibetan area of Sichuan Province, China. *Eur J Biol* 2010; 150: 209-207.
- 3- Ferrer J. Vaginal candidosis: epidemiological and etiological factors. *Inter J Gynecol* 2000; 71: 21-7.
- 4- Moreira D, Paula C. Vulvovaginal candidiasis. *Inter J Obstet* 2006; 92: 267-266.
- 5- Faraji R, Rahimi MA, Rezvanmadani F, Hashemi M. Prevalence of vaginal candidiasis infection in diabetic women. *Afr J Microbiol Res* 2010; 6: 2778-2773.
- 6- Bohanon NJ. Treatment of vulvovaginal candidiasis in patients with diabetes. *Diabetes J Care* 1998; 21: 451- 6.
- 7- Sobel JD. Vulvovaginal candidosis. *Lancet J* 2007; 369-71.
- 8- Grigoriou O, Baka S, Makrakis E, Hassiakos D, Kapparos G, Kouskouni E. Prevalence of clinical vaginal candidiasis in a university hospital and possible risk factors. *Eur J Biol* 2006; 126: 121-5.
- 9- Boselli F, Chiossi G, Garutti P, Matteelli A, Montagna MT, Spinillo A. Preliminary results of the Italian epidemiological study on vulvovaginitis. *Minerva Ginecol* 2004; 56: 149-53.
- 10- Ben-Haroush A, Yogev Y, Kaplan B. The importance of diagnostic work-up In the management of candidal vulvovaginitis. A prospective study. *Clin Exp Obstet Gynecol* 2004; 31: 113-6.
- 11- Goswami R, Dadhwal V, Tejaswi S, Datta K, Paul A, Haricharan RN, et al. Species-specific

prevalence of vaginal candidiasis among patients with diabetes mellitus and its relation to their glycaemic status. *Infect J* 2000; 41: 162-6.

- 12- Goswami D, Goswami R, Banerjee U, Dadhwal V, Miglani S, Lattif AA, et al. Patten of *Candida* species isolated from patients with diabetes mellitus and vulvovaginal candidiasis and their response to single dose oral fluconazole therapy. *Infect J* 2006; 52: 111-7.
- 13- Kent HL. Epidemiology of vaginitis. *Am J Obstet Gynecol* 1991; 165: 1168- 76.
- 14- Wentworth BB. *Diagnostic Procedures for Mycotic and Parasitic Infection*. 7nd ed. Washington DC: American Public Health Association; 1998.
- 15- Antony G, Saralaya V, Bhat K, Shalini M, Shivananda PG. Effect Phenotypic switching on expression of virulence factors by *Candida albicans* causing Candidiasis in diabetic patients. *Iberoam J Micol* 2009; 26: 202- 5.
- 16- Corsello S, Spinillo A, Osnengo G, Penna C, Guaschino S, Beltrame A, et al. An epidemiological survey of vulvovaginal candidiasis in Italy. *Eur J Biol* 2003; 110: 72-66.
- 17- Maccato ML, Kaufman RH. Fungal vulvovaginitis. *Curr J Gynecol* 1991; 3: 849- 52.
- 18- Peer AK, Hoosen AA, Seedat MA, Van-den-Ende J, Omar MA. Vaginal Yeast infections in diabetic women. *Afr J Med* 1993; 83: 727- 9.
- 19- Duerr A, Sierra MF, Feldman J, Clark LM, Ehrlich I, Dehovitz J. Immune Compromise and prevalence of *Candida* vulvovaginitis in human Immunodeficiency virus infected women. *Obstet J Gynecol* 1997; 90: 252- 6.
- 20- Otero L, Palacio V, Carreno F, Mendez FJ, Vazquez F. Vulvovaginal Candidiasis in female sex workers. *Int J AIDS* 1998; 9: 526- 30.
- 21- Sobel JD, Faro S, Force RW, Foxman B, ledger WJ, Nyirjesy PR, et al. Vulvovaginal candidiasis: epidemiologic, diagnostic, and therapeutic considerations. *Am J Gynecol* 1998; 178: 211- 203.
- 22- Malazy OT, Shariati M, Heshmat R, Majlesi F, Alimohammadian M, Tabari NK, et al. Vulvovaginal candidiasis and its related factors in diabetic women. *Tai J Obstet Gynecol* 2007; 46: 404- 399.
- 23- Sobel JD. Candidal vulvovaginitis. *Clin J Gynecol* 1993; 36: 153-65.

7/25/2012

The pattern of transmission in the market price of chicken meat in Iran

Seyed Nematollah Mousavi¹ and Neda Sedghi²

^{1,2}Department of Agricultural Economics, Marvdasht Branch, Islamic Azad University, Marvdasht, Iran

*Corresponding author: mousavi_sn@yahoo.com

Abstract: Marketing margins and price transmission between market chain has always been emphasized. Due to the importance of poultry in household food needs and a considerable number of product manufacturers in the country and its impact on policy makers and planners of the agricultural sector, the aim of this study transmission patterns in the market price of chicken meat in Iran. Monthly data for retail and wholesale prices was used during March 2001 to April 2012. Causality test results parasite - Granger showed that for both wholesale and retail levels, two-way causal relationship exists between the markets and prices in both markets are accepting of each other. Pattern results in a torque on the eve of the transfer price is symmetrical as well as emphasize the results of the Wald test to test it out suggests that the transfer price in the short term and long-term price transmission is symmetric.

[Seyed Nematollah Mousavi and Neda Sedghi. **The pattern of transmission in the market price of chicken meat in Iran.** *Life Sci J* 2012;9(4):1284-1291] (ISSN:1097-8135). <http://www.lifesciencesite.com>. 194

Keywords: symmetry, price transfer, chicken meat, Iran

Introduction

Price theory, is one of the main base neoclassical economics. Prices, the most important determinants of income level of farmers, traders and exporters of agricultural products and the level of economic prosperity are the consumers. Moreover, the relationship between producer and consumer price levels, an indicator of market performance and the welfare of producers and consumers will lose from the policy perspective is also important. The analysis of agricultural commodity prices, both economically and politically important. In this regard, many agricultural economists in the process of price transmission from farm to market structure and associated retail sales have shown interest. (Hosseini and Nikokar, in 2006, Hosseini and Dor andesh, 2006; Brarsn and Kavas, 1985 and Fraygvn et al, 1999).

Studies show that the vast majority of agricultural products, farm goods to the place of consumption, marketing and sales centers, are in different stages and depending on the process that occurs in every stage leading to increased product prices to be processed ahead of time. These changes and price increases are sometimes logical and convincing, and only include costs that are spent during the construction process But in some cases can be seen that the asymmetric price changes were increases in costs and the expected decrease or increase the prices of farm products, This change in consumer prices is symmetrical transmission (Soltani et al, 2008).

If the economy to services and marketing should be efficient, they can transmit the price to be symmetrical, but there is any weakness in the market and profit-

seeking individuals looking to profit are false, Ultimately lead to the transfer prices are asymmetric and this is happening while the transfer price can influence the welfare of the producer and consumer welfare. Given the importance of agriculture and the necessity of the transfer pricing analysis, here we try to review the process to review the changes in prices of selected products manufacturing, the wholesale price and retail price, the transfer price and the presence or absence of symmetry in the assessed market price. Survey statistics showed a majority of households in the recipient's food basket, often paired or materials directly or indirectly from agriculture are provided. Various compounds in the food basket per household, there is evidence that a considerable part of this material is a protein containing material. The main sources of protein can be pointed to red meat (beef and sheep), white meat (chicken and fish), and soya.

Among the items mentioned, the chicken is very important because in addition to its importance in terms of suitability for the position in a balanced diet, is economically important. Meat consumption pattern of households in the past three decades show that consumption of chicken meat has been rising more than other types. Azizi and Trkmanian study (2001) also showed that the share of expenditure in the period 1980-2000 through chicken meat has been rising and consumption pattern is oriented toward the chicken. With respect to periodic changes during the year that sees the chicken as the transfer price of the product selected for review, were considered in this study. In 2012 the number 17192 Farms with breeding broilers in the 13 878 numbers of active poultry units and poultry

unit on 3314 has been estimated (Statistical Center of Iran). Total poultry meat in more than 17 200 units with a capacity of about 225 million pieces (about 900 million pieces a year) is. 177 number of industrial slaughter of poultry slaughterhouses with 380 nominal capacities of thousand pieces per hour (about 912 million pieces per year) are (Iran Statistics Center, 2007). About 90 percent of farm and 75.8 percent of poultry slaughterhouses are privately owned (Department of Livestock Ministry of Agriculture, 2004). The chicken meat, 22.5 percent of per capita countries provide the protein needs of Iran's chicken meat industry producing over 1400 Thousand tons and 17.4 kg per capita production of over 15,000 units in recent years, producing an equal per capita consumption (the Department of Livestock Ministry of Agriculture, 2006). Per capita consumption of poultry meat in 1998 reached more than 18 kg (Electronic Information Corporation's support ANIMAL, 2009).

A review of studies:

Kvtrvmanyds, Zfyryv and Rabatzys (2008) in their study to investigate asymmetric price transmission between producer and consumer prices in the import of wood and they began in Greece and the accumulation of Johansson and two dynamic (error correction model and a model of artistic (GETS)) was used and the results of Granger causality tests and asymmetric price transmission models exist in the market GETS Wood emphasized the import role in determining producer prices Granger causality tests and techniques vital to know and by the accumulation has also been approved.

IL and Van Kramvn (2008) in a study of two econometric models, the threshold vector error correction and error correction vector Markov - switching were compared. Results showed that each model is appropriate for a specific type of non-linear transfer price and performance evaluation test at Monte Carlo techniques to estimate the two models was performed with the same data. Results showed both models to study the properties of transfer prices is consistent with economic theory, is appropriate. This is more than a threshold error correction model is used.

Farzaneh Taheri, Reza Moghadasi and Seyed Nemat Allah Mousavi (2010) to examine the structure and transport market in the world market price of corn began to explain the threshold. Transfer test results for the period 1974-2005 showed that the transfer price of world market prices to the domestic market in the long term and short-term symmetrical and asymmetrical transmission of world market prices to the domestic market is the transfer prices.

Zachary Farajzadeh and abdol Karim Ismaili (2009) the pattern of price transmission between world market and domestic market concluded that Iran's Pistachio, Pistachio between domestic and international prices and long-term two-way causal relationship exists. According to their data, and combined time-series analysis conducted in two parts. Results from analysis of combined data showed that transfer prices based on changes in the composition of pistachio as importer countries to reduce their number and to transfer the Iranian market and world market prices.

Seyed Safdar Hosseini, Habib Ullah Salami and Afsaneh Nekokar (2007) to examine the price transmission in the chicken market in the years 2002 to 2005, Iran began and concluded with Error Correction Model at all levels of poultry meat market in the long term and short-term asymmetric price transmission from poultry to the slaughter of poultry to retail price transmission elasticity of asymmetric and shows a live chicken in poultry prices more aggressively into the retail level transmitted to higher market prices are transmitted slowly.

Bekas and Farto (2006) to study the transfer price of beef and pork market in Hungary, and the results would suggest the beef market in the short term and long term is symmetrical, but pig meat market in the short term is asymmetric and wholesalers and retailers may price changes, the interim profit gain.

Goodwin and Hopper (2000) Relation between farm, wholesale and retail markets for pork in the United States using weekly price data for the period 1998-1987 were reviewed. Convergence threshold was used in this study, no differences in the results important shows.

Marzieh Gadami Kohestani, Afsaneh Nekokar and Arash Dor Andesh. (2010) examined the transfer price of chicken meat in Iran, using a threshold model in the years 2002-2009, and the results suggest that the transfer price of chicken meat in Iran asymmetric market regulation and policy, has no significant effect on the fluctuating price of chicken.

Method

In recent studies, several methods have been used for transfer pricing in various markets. Including the model of Hook and error correction model or ECM cited. Since this study is the use of monthly time series data, it is natural that some of the tests will be performed in this field. Granger causality test to check for such high prices from each other, Dicke Fuller unit root test to check the static data and Johansson convergence test to check the convergence between the variables considered.

If the variables are stationary time series, to review how the transfer price of the Hook (1997), the following relationship is used. Hook method to separate the effects of elasticity obtained from the farm show increase and decrease in price, assuming that with increased P_i and decreased with P_d are shown, the Hook method can be demonstrated as follows:

$$(1) P_{r1} - P_{r0} = \alpha_{0t} + \alpha_1 (\sum \Delta P_{ij}) + \alpha_2 (\sum \Delta P_{dj}) + E_t$$

The above equation can be easily estimated with OLS and also interrupts the Akayk test, Showartz or adjusted R2 is obtained. Coefficients α_1 and α_2 are positive and zero if the premise is true, the α_1 and α_2 are equal, and the transfer price of the symmetric and asymmetric otherwise transfer price will be. Using the Wald test of this hypothesis is examined.

If time series data with unit root tests Dicke Fuller was investigated and the static test, showed non-stationary, how to review transfer prices to other species. In this case should be investigated whether the data in the long run communicate with or not. Two common methods used for convergence tests, including tests of two-stage parasites - Granger and Uhansson is a multivariate test. If the data are non-convergent (with long-term data are not together), otherwise the model of Hook and error correction model (ECM) is used.

Dynamic series based on mass approach using error correction model (ECM) in which asymmetric adjustment clauses into the equation, we can stipulate more appropriate for asymmetric price transmission were achieved. To test the first mass Engel and Granger approach has been used. Approach based on the Engel and Granger (1987) and the variables used in this study were static variables measured once and then subtracting from the following equation is used to investigate co integration:

$$(2) p_t^r = a + a_1 p_t^w + m_t$$

Where p_t^w and p_t^r respectively the market price and the wholesale and retail market and is the waste. The static method using the following equation residual sentences are examined.

$$(3) \Delta m_t = r m_{t-1} + e_t$$

The next step error correction model (ECM) Number (4) the changes in p_t^r to the changes in p_t^w and the error correction term (ECT) can be related, is estimated. ECT deviation from the long-run equilibrium among

p_t^w and p_t^r the measures taken thus placing it in the ECM to p_t^r allow to not only react to changes in p_t^w the long-run equilibrium value of any distortions that may affect the course of the past instead of is needed to be corrected.

$$(4) \Delta p_t^r = a + \sum_{j=1}^k (b_j^+ D_t^+ \Delta p_{t-j+1}^w) + \sum_{j=1}^L (b_j^- D_t^- \Delta p_{t-j+1}^w) + f ECT_{t-1} + g_t$$

In the above first order difference operator, b_1^+ and b_1^- to increase the coefficient values and world market prices, f the error correction coefficient K and L is the length of delay and g_t waste of sentences.

Co integration analysis method of parasites - Granger static hysteresis sentences with symmetric price adjustment occurs. If you generally adjust quickly to the top and bottom is different, and this may lead to error is asserted (Abdvlay, 2000). For such a case, Anders and Granger (1998) model has been presented from other states under which asymmetry co integration while taking the test will pass. This test is based on deviation from the long-run relationship between (3) describes a process threshold (TAR)³ is considered as the following equation:

$$(5) \Delta m_t = I_t r_1 m_{t-1} + (1 - I_t) r_2 m_{t-1} + e_t$$

In the above equation I_t is called the Heaviside indicator is expressed as follows (Abdvlay, 2000):

$$(6) I_t = \begin{cases} 1 & \text{if } m_{t-1} \geq 0 \\ 0 & \text{if } m_{t-1} < 0 \end{cases}$$

In addition to the function (5) can be considered as the adjustment process by which the adjusted amount is influenced by prior period. This index will be mentioned below (Abdulai, 2000):

$$(7) I_t = \begin{cases} 1 & \text{if } \Delta m_{t-1} \geq 0 \\ 0 & \text{if } \Delta m_{t-1} < 0 \end{cases}$$

Use the index (7) compared with the index (6), especially when the asymmetry is such that changes in one direction than another, is very useful (Enders and Granger, 1998). In this test mode, the deviation from

long-term relationship as a self-described process threshold torque (M-TAR2) is.

Asserted error without disrupting the separate components, indicating the transfer is symmetric prices (Abdullahi, 2000) and to test for asymmetric price transmission costs, asymmetric error model stipulates Kramvn Van (1998) estimated that the following is doable. Convergence of correction obtained from the regression between P_t^r, P_t^f of equation (8) is obtained.

(10)

$$\Delta p_t^r = a + \sum_{j=1}^k (b_j^+ D^+ \Delta p_{t-j+1}^w) + \sum_{j=1}^L (b_j^- D^- \Delta p_{t-j+1}^w) + f^+ ECT_{t-1}^+ + f^- ECT_{t-1}^- + w$$

That $\Delta Pr = P_t^r - P_{t-1}^r$ is, L, K and n represent the length of the interruption to determine the optimal length of the interruption Akayyk and Showartz statistics used to estimate the model with different lag be. Finally, the model is preferred that have much less Akayyk and Showartz statistics . f^- , f^+ respectively the rate of retail price adjustment to negative shocks and positive marketing margin.

Using the coefficients in equation (10) to test the transfer price in the short and long term will be large and the transfer price can also be tested. If $\sum_{j=1}^k \beta^- = \sum_{j=1}^L \beta^+$ is established, there is symmetry in a transfer price. In other words, lower prices at the farm

(8) $ETC_t = P_{t-1}^r - \lambda_0 - \lambda_1 P_{t-1}^f$

That λ_0, λ_1 and ETC consists of two component coefficients are as follows:

(9) $ETC = ETC^+ + ETC^-$

The asymmetric error correction model can be expressed as an equation 10 is:

level and the change in price is the retail level. If $f^- = f^+$ is accepted, the transfer price in the long term is symmetric.

Results and Discussion

Using monthly time series data for retail and wholesale price of chicken meat is necessary first to analyze the static; therefore the unit root tests are used. Here, using the generalized Dicke Fuller was determined according to the following table. Retail price data after once difference are stationary at 1% of the wholesale price amounts after subtracting one of the 5% level are static.

Table 1: Unit root tests to determine the static variable, the price of chicken meat

price	The significance level	The critical values	T-statistics in data	T-statistics in the first order difference
Retail price	1%	-3.485	1.418	-3.113
	5%	-2.855		
	10%	-2.579		
Wholesale prices	1%	-3.485	1.423	-2.964
	5%	-2.855		
	10%	-2.579		

Source: Research findings

For estimating long-term relationship among the data, then it is necessary to use the Granger causality test, the relationship between the data set. As in Table (2) is observed in both equations is zero is rejected, it can be

concluded that two-way causal relationship between retail and wholesale market prices for both beef and chicken are accept each other's work and influence on the market.

Table 2: causal relationship between retail and wholesale price of chicken meat

Dependent variable	T-statistics	Test results (assuming zero: the absence of causality)	Causality
Retail price	6.188(0.0027)	Is zero can be rejected	Causality from retail to wholesale to be confirmed
Wholesale prices	4.782(0.0099)	Is zero can be rejected	Causality from wholesale to retail to be confirmed

Source: Research findings

Necessary to analyze the relationship co integration, estimated long-term relationship between wholesale prices and retail are two parameters. The estimates presented in Table 3 are retail price and wholesale price as the dependent variable is incorporated as an independent variable. Wholesale price index shows that the influence on the wholesale price retail price is a high level where each unit increase in wholesale prices, the

increase in retail price is 0.68 units. Statistic \bar{R}^2 variable coefficients show significant levels of the independent variable, dependent variable changes as well as shows. After estimating the long-term relationship, residual values are calculated from a series of sentences in the wholesale and retail prices co integration variables through Granger parasite tests, threshold and threshold used torque.

Table (3) long-run relationship between retail and wholesale price of chicken meat

The dependent variable	Independent variable				Statistics			
	Intercept		Wholesale prices		\bar{R}^2	D.W	F	Jarqu-Bera
	Coefficient	T-statistics	Coefficient	T-statistics				
Retail price	-869.28	-12.19	0.68	212.49	0.99	0.8	45154.03	4.5(0.1)

Source: Research findings

As we know, the causality test, Parasitological Engel and Granger, the assumption of symmetry is the residual series of positive and negative sentences, while the expression pattern Abdulai 2000 under conditions of moderate price increases moderated in comparison with the pattern obtained under conditions with reduced prices is different. Thus, in examining the phenomenon of co integration, we consider this issue. In addition to these parasite methods - Granger, co integration test

threshold and threshold torque can be provided by Enders and Granger 1998. Table 4 presents the results of the tests of time accumulation. The parasite test line - Granger static test sentences in the sterile waste of our long-term relationship between two variables in order to check the wholesale and retail prices have been expressed. Compare findings with data provided by Mac kinnon (1991) shows the level of 10% long-term relationship between wholesale prices and retail there.

The four default threshold and threshold torque are examined. Zero in the first test case $\rho_1 = 0 \rho_2 = 0$ is expressed and affirmed the rejection means there is zero correlation between two variables is long term according to the assumptions and the values of individual test statistic t, only is expressed by two other findings. The other is to be rejected $\rho_1 = \rho_2$ conversion process is a finite zero means that this assumption can be measured using a standard F test (Anders and Granger 1998). The third is to be expressed as $\rho_1 = \rho_2 = 0$ reject zero indicates there is a long term relationship in the shadow prices is assumed symmetry.

The findings of the analysis table (4) explain. According to the results, assuming $\rho_1 = \rho_2$ threshold method is accepted. Thus, a threshold test based on the transfer price is symmetrical. The test statistic $F \rho_1 = \rho_2 = 0$ amount equal to 16.8 is normal and indicates the default is zero. So we can say that based on a threshold test, the long-term relationship, the wholesale price and retail price transmission between the two variables is symmetric. It compares the results with the table numbers have been provided by Enders 2004. Findings in Table 4 show that the threshold method - the torque is zero and $\rho_1 = \rho_2 = 0$ and $\rho_1 = \rho_2$ also accepted. Therefore reflects both the symmetry of prices in the long relationship is long.

Table 4: Results of the test co integration

test co integration	Independent variable						Statistics			
	r		r_1		r_2		LM	F(Wald) $\rho_1 = \rho_2$	F(Wald) $\rho_1 = \rho_2 = 0$	Jarqu-Bera
	Coefficient	T-statistics	Coefficient	T-statistics	Coefficient	T-statistics				
The parasite - Granger	-0.407	-5.78	-	-	-	-	0.482(0.488)	-	-	11.41(0.003)
Threshol d method	-	-	-0.370	-3.90	-0.452	-4.28	0.57(0.45)	0.32(0.56)	16.80(0.00)	10.87(0.004)
Threshold method - a - torque	-	-	-0.200	-1.73	-0.089	-0.683	7.90(0.0057)	0.40(0.52)	1.74(0.17)	23.80(0.000007)

Source: Research findings

After analyzing the presence or absence of long-term relationship between wholesale prices and retail, with its corresponding error correction model in Table 5 is presented. Negative coefficients are negative and positive values of continuous variables disturbing components, show that two variables, wholesale and retail prices tend to converge in the long term and future periods if the deviation from equilibrium relation is a long-term, on its own The next period will be compensated. In fact, any deviation in relation to long-term equilibrium disappears after a while. Calculations show that in the long term and short-term price transmission in Iran's chicken meat market is

symmetric. Table (5) using the Wald test to test the transfer price paid. These results suggest that short-term and long-term zero is accepted and the transfer price is symmetrical. Are also reduced to less than wholesale prices on retail prices affect memory. In fact, for every 10% increase in price, wholesale price, retail price increases of 7.1%. So we can say that wholesale prices will move more aggressively into the retail price. States could provide 98% of retail price changes to explain statistics and other data, are emphasized as well as confirming the desirability of the LM test for a break up through first and second, reached the conclusion that the first order correlation and not the second.

Table 5: Results of the test co integration

	Coefficient	Standard deviation	T-statistics
variable	Intercept	3.67	37.62
	incremental Series of wholesale prices	0.71	0.011
	Reduction series of wholesale prices	0.74	0.021
	Uninterrupted series of first order decline in wholesale prices	0.037	0.02
	Incremental series of error correction	-0.31	0.12
	Reduction series, including error correction	-0.38	0.15
Statistics	F	1877.72	-
	\bar{R}^2	0.98	-
	LM	1.23(0.26)	-
	Jarqu-Bera	30.90(0.00)	-
	Wald (Symmetrical short-term transfer)	1.40(0.23)	-
	Wald (Equality clauses error correction coefficients: the transfer of long-term symmetric)	0.06(0.80)	-

Source: Research findings

Suggestions:

In this study, retailers and wholesalers in the market price of chicken meat in Iran spent. Required data from March 2001 to April 2012 were collected and used. Wholesale and retail prices have increased and the results of Granger causality tests indicate two-way causal relationship between retail and wholesale prices are. Also through the threshold and threshold torque is reached the conclusion that $p_1 = p_2$ and $p_1 = p_2 = 0$ was accepted and the existence of asymmetric price transmission is emphasized. Through the parasite - Granger found that long-term relationship between the level of 1% of wholesale and retail prices there. Values of the LM statistic represents the Autocorrelation between their first and second, that the results of the first and second interruption, the This is your first and second Autocorrelation test for symmetry or asymmetry as well as the pricing is done using the Wald test suggests symmetry in the short and long term is the price of chicken meat. According to Van Kramvn Tayvbadl method, in the period studied, there is a symmetric price behavior in the short and long term be recognized. The different results of the study Hosseini

and Nikokar (2005) are similar but the result of long-term is symmetry Hosseini et al (2008). So the government can transfer the pattern with respect to price and those involved in its planning and policy, policy action to stabilize prices in certain time periods. The findings suggest that the increase in wholesale prices with a severity greater than the wholesale prices are transmitted to the retail level that indicates weakness is part of marketing. Therefore recommended in order to maintain a symmetric price transmission cooperative consisting of wholesalers, retailers and even the dealers to be approached at different levels of the transfer market and eliminating unnecessary middlemen and market transparency, asymmetric price transmission sustained. Also supportive policies in order to increase bargaining power can be helped to overcome this problem, but price policies can be very useful because the portion of profits obtained from the intermediaries. Increased competition in the market for chicken meat is recommended whenever possible to reduce government interference and using appropriate mechanisms such as the development of futures markets and benefiting from an insurance company's services, risks in the field of manufacturers and retailers to at least reduced. It is noteworthy that the imperative necessity of government

intervention in infrastructure development is undeniable.

List of resources

- 1- Electronic information to support the company's Animal .2009. WWW.iranslal.com
- 2- Hosseini. C. s, Nikokar. A. (2006), review how the transfer price of chicken meat in Iran and its effect on the market sidelines, Iranian Journal of Agricultural Sciences, No. 2-37
- 3- Hosseini. C. S, Salami. H, Nikokar. A. (2007), the pattern of price transmission in the chicken market in Iran, Journal of Agricultural Economics, Volume 2, Number 1: 21-1
- 4- Dorandesh. A., Nikokar. A., Hosseini. S. (2010), the pattern of price transmission in the egg market in Iran, Agricultural Economics, Volume 4, Number 3: 152-135
- 5- Soltani.g .Najafi. B, Trkmanan. J(2008), agricultural management, Shiraz University Press, Fifth Printing, Shiraz.
- 6- Taheri. F., Mogadas. R., Mousavi. N. (2010), Market Structure and transport in the world market price of corn, Agricultural Economics, Volume 4, Number 3: 209-185.
- 7- Farajzadeh. Z, Ismail. A. K. (2009), the transfer price of pistachios in the world market, Journal of Agricultural Economics and Development, Number 71, Fall 2010.
- 8- Gadami kohestani. M., Nikokar. A, Dorandesh. A. (2010), a threshold model of transmission on the market price of chicken meat in Iran, Journal of Agricultural Economics and Development, Volume 24, Number 3: 392-384.
- 9- Azizi. J, Trkmanian. J (2001), estimation of demand functions for meat in Iran. Journal of Agricultural and Development Economics, 34: 237-217
- 10- Statistical Center of Iran (2007). "Statistical Yearbook of the whole country."
- 11- Center for Animal Affairs Ministry of Agriculture. In 2006. "Summary Annual Report Office of breeding birds and bees."
- 12- Abdulai A(2000), Spatial Price Transmission and asymmetry in the Ghanaian Maize Market, Journal of Development Economics 63:327-349
- 13- Bekaucs L.Z., I. Ferto, G.S. Gabor (2007)"price transmission in the Hungarian vegetable Sector", studies in Agricultural Economics No.106.p.23-40.
- 14- Brorsen B.W., Chavas J.P., Grant W.R., Schanke L.D (1985), "Marketing margins and price uncertainty: The Case of the U.S. Wheat Market", Amer. J. Agr. Econ. No.67.p.521-28.
- 15- Enders W., Granger C.W.J(1998), Unit-root tests and asymmetric adjustment with an example using the term structure of interest rates, Journal of Business & Economic Statistics 16:304-311
- 16- Engle R.F., Granger C.W.J (1987). Cointegration and error correction: representation, estimation and testing, Econometrica, 55 (2): 251–280.
- 17- Frigon M., Maurice D., Romain R (1999), Asymmetry in farm-retail price transmission in the northeastern fluid milk market. Food Marketing Policy Center. Research Report No.45.
- 18- Goodwin B.K, C.Harper(2000),Price transmission threshold behavior, and Asymmetric adjustment in the U.S. Pork sector, Journal of Agricultural and Applied Economics, 32(3):53-543.
- 19- . Ihle R., S.V. Cramon - Taubadel(2008) "A Comparison of Threshold Cointegration and Markov-Switching Vector Error Correction Models in Price Transmission Analysis", NCCC-134 Conference on Applied Commodity Price Analysis, April 21-22.
- 20- Koutroumanidis T., E. Zafeiriou, G. Arabatzis(2009)" Asymmetry in price transmission between the Producer and the consumer Prices in the wood sector and the role of imports: The case of Greece", Forest Policy and Economics, Vol.11, Issue 1, PP. 56-64.
- 21- Mackinnon J.G (1991), Critical values for cointegration tests. In: Engle, R.F., Granger, C.W.J_Eds., Long-Run Economic Relationships Readings in Cointegration. Oxford Univ. Press, New York

10/19/2012

Substance Use Among Non-fatally Injured Patients Attended Emergency Departments in North-East of Iran; Sabzevar

Zardosht Roqhaye¹, Hashemian Masoumeh², Moghaddamhosseini Vahideh³, Akaberi Arash^{4*}

¹ Faculty member of Nursing, Department of para medical, Sabzevar University of Medical Sciences, Sabzevar, Iran

² Faculty member of Health Education, Department of Health Education, Sabzevar University of Medical Sciences, Sabzevar, Iran

³ Faculty member of Midwifery, Department of Nursing and Midwifery, Sabzevar University of Medical Sciences, Sabzevar, Iran

^{4*} Corresponding Author; Faculty member of Biostatistics, Addiction and Behavioral Sciences Research Center, North Khorasan University of Medical Sciences, Bojnurd, Iran.

Email: arashdata@yahoo.com; a.akaberi@nkums.ac.ir

Abstract: Introduction: During the recent decades, Iran has suffered from drug abuse and its consequences. On the other hand, recently, the occurrence of injuries and those related to mortality have increased dramatically in Iran. We have conducted this study to examine substance use among patients attended to emergency departments. **Methods:** This cross sectional population-based study was performed from January-June 2008. In this study 318 non fatally injured people who were referred to emergence departments of Sabzevar city were evaluated based on multi stage sampling. Abuse of amphetamines, marijuana, opium (opium and heroin) as illegal drugs and codeine and methadone as medical drugs were evaluated through standard methods. Extraction of opium and heroin was performed by using chromatography. Statistical analyses were perused using Chi-square, exact Fisher, logistic regression tests by using SPSS software. Significance level was considered as 0.05. **Results:** Mean±SD of age of the evaluated persons was 36.1±18.1 and 23% of them were female. From total number of injured cases, 36.5% of cases were driver, 10.7% passenger, 7.2% pedestrian, fall 41.8% and 3.8% violence. Prevalence of use of illegal drugs was 31.1% and there was not any significant difference between the male and female groups. Among the illegal drugs, the maximum use was for opium and the minimum was for amphetamine and marijuana. The maximum prevalence of abuse was observed in pedestrians and was 39.1% and the minimum was observed in drivers and was 27.6%. There was not any significant relation between the type of injury and abuse of illegal drugs. Medical cases were 23.6% among the total cases. **Conclusion:** Among the injuries the most frequent was accident and the prevalence of abuse of illegal drugs in the injured cases referred to emergency departments in Sabzevar city was relatively high. Our results are indicating that it is necessary to use precautionary strategies to reduce the abuse of drugs in Sabzevar.

[Zardosht Roqhaye, Hashemian Masoumeh, Moghaddamhosseini Vahideh, Akaberi Arash. **Substance Use Among Non-fatally Injured Patients Attended Emergency Departments in North-East of Iran; Sabzevar.** *Life Sci J* 2012;9(4):1292-1297] (ISSN:1097-8135). <http://www.lifesciencesite.com>. 195

Keywords: Substance use, Illegal drugs, Injury, Non-fatal, Emergency department

Introduction

Drug Abuse is one important health problems in the world. Based on the report by world health organization (WHO) in 2010, 153-300 million people with age ranging from 15-64 years old have used illegal drugs at least once during the last year. Furthermore it was reported 99000-253000 cases of death due to use of such drugs.(1) Death from use of these drugs likes the peak of an ice mountain, so that once use of such narcotic drugs can have serious and unpredictable affects and frequent use of such drugs can have functional and structural damages to the brain and a cause of cardiovascular diseases(2), gastrointestinal disorders(3), damage to other vital organs and hazardous sexual behaviors(4), affect on family relationships, reduction of visual acuity and

violent behaviors.(5) Furthermore, the studies on abuse of drugs are implying the increase of referring of cases to emergency departments due to their various injuries. (6-8) According a report by drug abuse warning network (DAWN) in 2009, there were 973591 cases of abuse of illegal drugs referred to emergency centers at USA urban areas. (9) On the other hand, injuries due to accidents are accounted as the main cause of referring to the emergency departments. Based on the estimations, there are 1.2 million fatal cases per year which are killed through accidents all around the world. There are also 5 millions of cases which are annually injured from the accidents. It is predicted that if there will not adopted any new precautionary strategies, the values will increase up to 65% within the next 20 years. (10)

Abuse of psychotropic, illegal and medical drugs is accounted as a risk factor with this regard. Based on the results of the studies in Spain in 2009, from all driving accidents, 34.4% of cases in men and 16.2% of cases in women were originated from abuse of drugs by driver. (11) This value amounts to 10.5% and 25% respectively in Shanghai (in 2010) and Norway (2011). (13,13)

In recent years, there was a considerable increased rate of trauma, injuries and death due to drugs abuse in Iran. Injuries are accounted as the second cause of death and the first cause of missing the useful duration of life. (14) According to the studies in 12 Iranian provinces in 2005, the prevalence of death from accidents was 44 cases per 100000. In 2004, the value was 14.5 cases in USA and 6.7 cases in Sweden per 100000 which are lower than that in Iran. (15,16) Sabzevar is one of the most important cities in the eastern part of Iran and is in the vicinity of Afghanistan and in the pathway between Mashhad and Tehran city which is capital of Iran. Therefore being as a subject of high prevalence of traffic and accident death and as well as entrance of narcotic drugs. Thus study of prevalence of drug abuse between the injured people referred to emergency departments of Sabzevar city is important and is the aim of the present study, of our knowledge, there are few studies in this field.

Materials and methods

Study design, setting and participants

The present work is a cross-sectional population-based study. The subject population was the non fatal injured cases that were referred to the emergency departments in Sabzevar city from January to June 2008. Based on the number of injured cases in similar period in the year 2007, following an estimation of ratio of drug abuse to have significance level of 0.05 in confidence level of 95% the number of cases was estimated to be 307. However we have evaluated 318 cases in this study based on multi-stage categorical-systematic sampling. For this purpose each emergency department was taken into account as a separate category and in each department the samples were selected and evaluated systematically.

Each injured alive person with age higher than 12 years that was receipted in emergency department in Sabzevar city due to accident, falling or violence was included as a sample. To avoid including the false positive cases in our study, those people who received painkiller by the ambulance nurse or were dead before sampling or avoided to continue the sampling process were excluded from the study. The samples' data was collected by using questionnaire including demographic questions such as sex, age, education, job, lodging (city or village),

usage of tobacco, cause of injury, namely information on the accident (as a driver, passenger or pedestrian), falling and violence.

Evaluation on abuse of drugs

For detection of drug abuse, a sample of 5-10 cc urine was taken from the case following hospitalizations in the emergency department. For unconscious ones or those without balance the sample was taken through inserting a catheter into bladder. It should be noted that the catheter was routinely inserted for these types of cases in the hospitals. The urine samples were then maintained in a refrigerator and submitted for analysis in laboratory after the treatment shift. All the laboratory analysis were performed by expert persons. For detection of type of drug, e.g. morphine, marijuana, amphetamine, standard test tabs. Thin layer chromatography (TLC) method was used for distinguishing between opium and heroin. In the present study, use of amphetamine, marijuana and opium was assigned as abuse of contraband drugs. However those cases with use of codeine and methadone were included in the medical group.

Statistical analyses

In analysis of data, ages of cases were categorized to three age groups: 12-29 years (young), 30-59 years (middle-aged) and ages higher than 60 (old). Pearson Chi-Square test and, if needed, Fisher's exact test, was used to analysis the categorical data. Independent t-test was used for comparison of means of quantitative variables for two sex groups. For estimation of chance ratios, logistic regression method was utilized. The analyses were performed with SPSS15. Significance level was considered as 0.05.

Results:

From total number of 318 cases studied, 73 persons (23%) were female and 245 persons (77%) were male. Mean±standard deviation (SD) of age of the cases was 36.1±18.1 years. Mean±SD in the women and men groups were 44.4±18.1 years and 33.6±17.3 years, respectively. Mean age in the women group was significantly higher than that in the men group ($p < 0.001$). Cause of injury in 173 cases was accident (36.5% as driver, 10.7% as passenger and 7.2% as pedestrian). In the remaining 133 (41.8%) and 12 (3.8%) cases the cause of injury was respectively falling and violence.

Among the men, the most frequent cause of injury were respectively driving with 45.7% frequency (112 cases) and falling with 35.9% (88 cases). These values in the women group respectively amount to 61.6% (45 cases) for falling and 21.9% (16 cases) for passenger. Young persons had higher education level and also their referred to the

Table 1. Frequency of evaluated variables versus sex and age in non fatally injured patients referred to emergency departments in Sabzevar

Age groups(years)	Female			p-value	Male			p-value	
	<30	30-59	60<		<30	30-59	60<		
Cause of accident	Driver	2 (11.8)	1 (2.7)	1 (5.3)	0.141 f*	74 (56.9)	34 (41.0)	4 (12.5)	<0.001
	Passenger	4 (23.5)	11 (29.7)	1 (5.3)		8 (6.2)	9 (10.8)	1 (3.1)	
	Piade	1 (5.9)	3 (8.1)	1 (5.3)		8 (6.2)	3 (3.6)	7 (21.9)	
	Fall	8 (47)	21 (56.8)	16 (84.2)		31 (23.8)	37 (44.6)	20 (62.5)	
	Injury	2 (11.8)	1 (2.7)	0 (0)		9 (6.9)	0 (0)	0 (0)	
Education	Not educated	3 (17.6)	11 (29.7)	18 (94.7)	f<0.001	3 (2.3)	15 (18.75)	17 (58.6)	f<0.001
	Primary education	2 (11.8)	18 (48.7)	1 (5.3)		20 (15.4)	32 (40.0)	8 (27.6)	
	High school	11 (64.7)	7 (18.9)	0 (0)		101 (77.7)	25 (31.25)	4 (13.8)	
	University	1 (5.9)	1 (2.7)	0 (0)		6 (4.6)	8 (10.0)	0 (0)	
Conditions in admission time	alert	13 (76.5)	25 (69.4)	14 (73.7)	F=0.900	90 (70.3)	62 (75.6)	27 (84.37)	0.428
	Semiconscious	3 (17.6)	6 (16.7)	4 (21)		25 (19.5)	14 (17.1)	2 (6.3)	
	Unconscious	1 (5.9)	5 (13.9)	1 (5.3)		13 (10.2)	6 (7.3)	3 (9.38)	
Way refer	By self	-	-	-	0.198	9 (7.0)	12 (14.6)	0 (0)	0.003
	other person	10 (58.8)	23 (63.9)	16 (84.2)		57 (44.2)	40 (48.8)	24 (75.0)	
	Ambulance	7 (41.2)	13 (36.1)	3 (15.8)		63 (48.8)	30 (36.6)	8 (25.0)	

*f= Fisher's Exact Test

emergency department using ambulance were more frequent than those in other age groups (Table 1).

From all cases studied 31.1% (99 cases) had illegal abuse of drugs. Among the illegal abuses the most frequent use was related to opium (28.9%), however abuse from marijuana and amphetamine was relatively much lower (Table 1). There was not observed any significant difference between the abuse of illegal drugs in men (with 31% frequency) and women (with 31.5% frequency) groups. The most abuse from the illegal drugs was in the 30-59 age range and there was not observed any significant relation between the age and type of injury with abuse of illegal drugs. From all cases evaluated, 75 persons (23.6%) had used medical drugs including codeine or methadon. The age group with age of higher 60 years had the most use of medical drugs which amounted to a frequency of 39.2%. The relation between use of medical drugs and age was statistically significant ($p=0.015$). Besides, the relationship between the type of accident and having abuse of amphetamine and methadone was statistically significant (Table 2).

The Odds Ratio of illegal drug abuse in the aged group to that in the young group was $OR=1.603$ ($p\text{-value}=0.706$, $CI95\%$ for OR : 0.952, 2.701). The value amounts to $OR=1.266$ for the elderly group to that of young group ($p\text{-value}=0.506$, $CI95\%$ for OR : 0.631, 2.538). There was not observed any significant difference between the Odds Ratio of abuse from illegal drugs in various age ranges. The Odds Ratio of use of medical drugs in the aged group to that of young group was $OR=1.125$ ($p\text{-value}=0.697$, $CI95\%$: 0.621, 2.040). The ratio was 2.625 for that of elderly

group to that of young group ($p\text{-value}=0.006$, $CI95\%$: 1.312, 5.252).

There was not observed any relation between the type of injury and abuse of illegal drugs in the smoking and non-smoking groups. However a significant relation existed between smoking and the abuse of illegal drugs such as opium, amphetamine, codeine and methadone. There was not seen any significant relation between the education level or lodging (city or village) and type of accident (car accident or other types). However a relationship existed between job and type of accident ($p<0.001$). The relationship was in the form that the accidents were most often in drivers (73.3% of total number of accidents) when compared to those had official jobs (33.3%).

Discussion

The present study is among the few researches performed in Iran on the two important social subjects with long-term side effects: drug abuse and injuries. Based on our results, 31.1% of non-fatal injured persons who referred to emergency departments had abuse of illegal drugs. Furthermore, 23.6% of cases had use of medical drugs including codeine and methadone.

Salvatore in his review on use of illegal drugs and prevalence of injuries in a period of time between 1996-2003, has evaluated the prevalence of abuse of illegal drugs in injured cases referred to emergency department. He used blood and urine sample for detection of drugs and the prevalence detected from analysis of these two samples in the

studied persons was respectively 35-40%. The most frequent used drug were cannabis and cocaine. The first drug had a frequency of 9.2-34.2% of use.(17) In the present study the prevalence of abuse of the illegal drugs is in this range. Use of cannabis in this study was lower than of that in other studies but higher than use of opium and its derivatives. Based on a rapid situation assessment (RSA) study on abuse of drugs in Iran in 1998-1999, the most used drug was opium and its derivatives, heroine and cannabis. In the recent years based on the reports by governmental responsibilities, the use of new industrial narcotic drugs is more commonly intended. However there are many regions in Iran with traditional and common use of opium and its derivatives.(18)

By considering this fact that native and cultural variables have high impacts on consumption patterns of a population, it would be justify the difference between the abuse of opium and that of cannabis and amphetamine and the similarity between the abuse in non-fatal injured men and women in this study. However our results of abuse prevalence in injured persons are similar to those reported in other studies in this field. (17,19,20)

In a study by Bogstranda in 2011, it was reported that although abuse of alcohol and illegal drugs in men was significantly higher than women, abuse of medical drugs was significantly higher than that in men group.(13) World health organization (WHO) in a report in 2010 announced that the abuse of drugs in men are higher than in women in relatively all parts of the world.(1)

There was not observed any significant difference between abuses of illegal drugs in various age ranges groups. The most frequency of users of illegal drugs were elderly people in age range of 30-59 years. From a epidemiologic research on drug abuse in Iran which has been performed in 2002, the most and least use of illegal drugs were respectively related to age groups of 25-34 and 55-65 years.18In a study by Pérez in 2009 abuse of drugs was higher in the age range of 18-39 years than that in age group with age higher than 40 years.(21)

The main point of this study is high use of medical drugs and codeine in elderly age people (those with ages higher than 60 years). This fact could be due to a number of difficulties and physical pains in this age group which increase considerably theintend for use of codeine as a medical drug. The most frequent cause of referring the injured people to emergency persons was traffic accidents. Frequency of use of medical drugs and abuse of illegal drugs were higher in pedestrians than that in other injured groups. In approximately one third of accident cases (30.1%) there was an abuse of drugs. However it was not observed any relation between prevalence of

accident and abuse of drug. On the other hand, Woratanarat in 2009 has found a significant relation between prevalence of accident and use of illicit drug.20However target population in the present study differs from that in the study by Woratanarat, because we have evaluated all types of injuries referred to emergency departments but in the study by Woratanarat only the drivers were studied. In a study by Drummer in 2011 performed in Australia, 35% of accidents were related to abuse of drugs, with most use of cannabis.21In a study by Péreza in 2009 in Spain, it has been observed abuse of drugs in 28.8% of accidents. In this study traffic accidents were the second cause of referring of people to emergency departments, the first one was violence.(21)

Based on the main aim of this study, the results of various statistical analyses have shown a significant relationship between drug abuse and type of accident in the injured persons. In a review article by Salvatore in 2006, it was reported that in the previous studies it was not observed any relation between the abuse of illicit drugs and prevalence of injuries, however the results are reverse for use of alcohol.(17)

Conclusions and implications for prevention

In the present study, ratio of abuse of drugs in the injured people referred to emergency departments was relatively high, on the other hand comparable with the values reported in other published studies. It seems that one of the best strategies to prevent the long term effects from injuries and appropriate diagnosis and treatment of abuse of drugs is performing routine screening tests in the emergency departments. By this way therapeutic actions are applied accordingly on the injured patient. Besides, it is an aid to detect to diagnose and cure the abuse of drugs in the cases with long term use of such drugs. The results of this study have also indicated that there was a high use of medical drugs in the elderly persons. This fact reflects this point that it is necessary to take into account the health problems especially in this group of people. Executing training programs to promote their health knowledge is helpful for this purpose.

Limitations and positive points of this study

There were limitations in this study:

There were cases which have received analgesic drugs by administration of nurse of ambulance. These cases were not taken into account in this study and can be a source of underestimation in the frequency of abuse of drugs.

The highlights of this study

- This study is among the few researches performed in Iran on the drugabuse in injured people.

- Evaluation of abuse of drugs was performed based on standard methods with a high level of precision.

References

1. UNODC, World Drug Report 2012 (United Nations publication, Sales No. E.12.XI.1). p: 13. available from: www.unodc.org/documents/data-and/WDR_2012_web_small.pdf.
2. Gold MS, Kobeissy FH, Wang KK, Merlo LJ, Bruijnzeel AW, Krasnova IN, Cadet JL. Methamphetamine- and trauma-induced brain injuries: comparative cellular and molecular neurobiological substrates. *Biol Psychiatry*. 2009 Jul 15;66(2):118-27.
3. Li FC, Yen JC, Chan SH, Chang AY. Defunct brain stem cardiovascular regulation underlies cardiovascular collapse associated with methamphetamine intoxication. *J Biomed Sci*. 2012 Feb 7;19:16.
4. Tamika C. B. Zapolski, Melissa A. Cyders, and Gregory T. Smith Positive Urgency Predicts Illegal Drug Use and Risky Sexual Behavior- *Psychol Addict Behav*. 2009 June; 23(2): 348–354.
5. World Health Organization. World health report 2002: reducing risks, promoting healthy life. Geneva:WHO;2002. Available from: who.int/whr/2002/en/summary_riskfactors_chp4.pdf.
6. Walsh, J.M., de Gier, J.J., Christopherson, A.S., Verstraete, A.G., Drugs and driving. *Traffic Inj Prev*. 2004;5, 241–253.
7. Cherpitel, C.J., Alcohol and injuries: a review of international emergency room studies since 1995. *Drug Alcohol Rev*. 2007, 26, 201–214.
8. Vitale, S., Van De Mheen, D. Illicit drug use and injuries: a review of emergency room studies. *Drug Alcohol Depend*. 2006, 82, 1–9.
9. Substance Abuse and Mental Health Services Administration, Center for Behavioral Health Statistics and Quality. (December 15, 2011). The DAWN Report: Illicit Drug-Related Emergency Department Visits in Metropolitan Areas of the United States: 2009. Rockville, MD.
10. World report on road traffic injury prevention. [Internet]. [accessed 16.07.12]. Available from: www.who.int/violence_injury_prevention/publications/road_traffic/world_report/en/index.html.
11. Santamariña-Rubio E, Pérez K, Ricart I, Rodríguez-Sanz M, Rodríguez-Martos A, Substance use among road traffic casualties admitted to emergency departments. *Brugal MT, et al. Inj Prev*. 2009 Apr;15(2):87-94.
12. Zhou Xianyi; Cang, Yong; Yan, Hui; Bu, Jun; Shen, Baohua :The prevalence of drugs in motor vehicle accidents and traffic violations in shanghai and neighboring cities; *Accident analysis & Prevention* NOV 2010, 42(6);2179-2184.
13. Stig Tore Bogstrand, b, Per Trygve Normann, Ingeborg Rossow, e, Margrete Larsen, Jørg Mørland, g, Ivinde Ekeberg. Prevalence of alcohol and other substances of abuse among injured patients in a Norwegian emergency department. *Drug and Alcohol Dependence* 117 (2011) 132–138.
14. Montazeri A. Road-traffic-related mortality in Iran: a descriptive study. *Public Health*. 2004; 118: 110 – 113.
15. K Bhalla, M Naghavi, S Shahraz, D Bartels, C J L Murray. Building national estimates of the burden of road traffic injuries in developing countries from all available data sources: Iran. *Injury Prevention* 2009;15:150 –156
16. Michael Sivak, Juha Luoma, Michael J. Flannagan, C. Raymond Bingham, David W. Eby, Jean T. Shope, “Traffic safety in the U.S.: Re-examining major opportunities” *Journal of Safety Research* 38 (2007) 337–355.
17. Salvatore Vitale, Dike van de Mheen. Illicit drug use and injuries: A review of emergency room studies. *Drug and Alcohol Dependence*, 82 (2006) 1–9.
18. Demand Reduction. [Internet]. [accessed 11.05.12]. Available from: <http://www.dchq.ir/html/index.php?module=D8B5D981D8ADD8A7D8AA20HTML&func=display&pid=365&theme=Printer>.
19. Patarawan Woratanarata, Atiporn Ingsathitb, Paibul Suriyawongpaisal, Sasivimol Rattanasiri b, Porn-tip Chatchaipunb, Kanokporn Wattayakorn, et al. Alcohol, illicit and non-illicit psychoactive drug use and road traffic injury in Thailand: A case-control study. *Accident Analysis and Prevention* 41 (2009) 651–657.
20. Olaf H. Drummer, Irene Kourti a, Jochen Beyer, Penny Tayler, Martin Boorman, Dimitri Gerostamoulos, The prevalence of drugs in injured drivers. *Forensic Sci. Int.* (2011), doi:10.1016/j.forsciint.2011.01.040.
21. Katherine Pérez, Elena Santamarina-Rubio, Alicia Rodríguez-Martos, Ma Teresa Brugal, Isabel Ricart, Josep Mara Selves, et al. Substance use among non-fatally injured patients attended at emergency departments in Spain. *Drug and Alcohol Dependence* 105 (2009) 194–201.

Table 2. Results of drug abuse tests in non fatally injured patients referred to emergency departments in Sabzevar

	Opium	TSH	Amphetamines	Methadone	Codeine	Medical [#]	Illegal drugs ^{##}
Sex	+ ^{\$}	-	+	-	+	-	+
	-\$	+	-	+	-	+	-
Females	52 (71.2)*	69 (94.5)	71 (97.3)	2 (2.7)	59 (80.8)	14 (19.2)	57 (78.1)
	21 (28.8)	4 (5.5)	2 (2.7)	2 (2.7)	14 (19.2)	16 (21.9)	50 (68.5)
Males	174 (71.0)	237 (96.7)	237 (96.7)	7 (2.9)	193 (78.8)	52 (21.2)	186 (75.9)
	71 (29.0)	8 (3.3)	8 (3.3)	7 (2.9)	52 (21.2)	59 (24.1)	169 (69.0)
<i>p</i> -value	0.972	0.481 f**	1 f	1 f	0.869	0.702	0.937
Age groups(years)							
< 30	111 (75.5)	142 (96.6)	145 (98.6)	2 (1.4)	120 (81.6)	27 (18.4)	118 (80.3)
	36 (24.5)	5 (3.4)	2 (1.4)	2 (1.4)	27 (18.4)	29 (19.7)	108 (73.5)
30- 59	78 (65.0)	115 (95.8)	116 (96.7)	4 (3.3)	98 (81.7)	22 (18.3)	94 (78.3)
	42 (35.0)	5 (4.2)	4 (3.3)	4 (3.3)	22 (18.3)	26 (21.7)	76 (63.3)
60 <	37 (72.5)	49 (96.1)	47 (92.2)	4 (7.8)	34 (66.7)	17 (33.3)	31 (60.8)
	14 (27.5)	2 (3.9)	4 (7.8)	3 (5.9)	34 (66.7)	20 (39.2)	35 (68.6)
<i>p</i> -value	0.164	0.927	0.057	0.17	0.054	0.015	0.205
Injury circumstances							
Driver	87 (75.0)	112 (96.6)	114 (98.3)	2 (1.7)	90 (77.6)	26 (22.4)	88 (75.9)
	29 (25.0)	4 (3.4)	2 (1.7)	2 (1.7)	26 (22.4)	28 (24.1)	84 (72.4)
Passenger	24 (70.6)	32 (94.1)	32 (94.1)	2 (5.9)	26 (76.5)	8 (23.5)	24 (70.6)
	10 (29.4)	2 (5.9)	2 (5.9)	2 (5.9)	8 (23.5)	10 (29.4)	23 (67.6)
Pedestrian	15 (65.2)	21 (91.3)	19 (82.6)	4 (17.4)	18 (78.3)	5 (21.7)	15 (65.2)
	8 (34.8)	2 (8.7)	4 (17.4)	3 (13.0)	18 (78.3)	8 (34.8)	14 (60.9)
Falls	92 (69.2)	129 (97.0)	131 (98.5)	2 (1.5)	107 (80.5)	26 (19.5)	105 (78.9)
	41 (30.8)	4 (3.0)	2 (1.5)	2 (1.5)	26 (19.5)	28 (21.1)	90 (67.7)
Violence	8 (66.7)	12 (100.0)	12 (100.0)	0 (0)	11 (91.7)	1 (8.3)	11 (91.7)
	4 (33.3)	0 (0)	0 (0)	0 (0)	11 (91.7)	1 (8.3)	8 (66.7)
<i>p</i> -value	0.808	0.498 f	0.009 f	0.044 f	0.807	0.369	0.825
Total	226 (71.1)	306 (96.2)	308 (96.9)	10 (3.1)	252 (79.2)	66 (20.8)	243 (76.4)
	92 (28.9)	12 (3.8)	308 (96.9)	9 (2.8)	252 (79.2)	75 (23.6)	219 (68.9)

[#] Medical = Codeine or Methadone ^{##} Illegal drugs = Opium or TSH or Amphetamines ^{\$}Result of Test was Positive, ^{\$\$}Result of test was Negative *Number(percent) **f = Fisher's Exact Test

Educational creativity of teachers can be changed using a suitable management and leadership style of managers (standard-oriented and relation oriented)

Homa Ghafourian*

Department of Education, Islamshahr Branch, Islamic Azad University, Islamshahr, Iran

*homaghafourian@yahoo.com

Abstract: Improvement and development of country depends on progress of management system of the society, in which the role of manager and employees are very special. The main cause of existentiarity of managers and their basic responsibility are playing managing roles, decision-making, adopted thinking methods, and their innovation in educational system, especially in school level. Thinking methods of managers require more effective and better using of financial and human resources. To achieve organizational objectives, manager is expected to use management principals, adopt appropriate methods, and have suitable human relations and qualified operation to form creative and productive organization, an environment without any stress and tension. In this paper we reviewed the different ways of relationship between leadership style of managers and creativity of primary school teachers to create a bed for selecting the best management methods and increase creativity of primary school teachers via a main question "is there any meaningful relation between leadership style of managers and creativity of teachers?". We concluded that manager and his management styles are the most important factors of each organization. If a manger wants to be successful, he should use the best leadership style to interest employees to work environment and strengthen motivation in all employees.

[Homa Ghafourian. Educational creativity of teachers can be changed using a suitable management and leadership style of managers (standard-oriented and relation oriented). *Life Sci J* 2012;9(4):1298-1303] (ISSN:1097-8135). <http://www.lifesciencesite.com>. 196

Key words: Educational creativity, management system, teachers, leadership style

1. Introduction

Significance of research:

Today, due to the importance of management role in organization and increasing number and quality of organizations, an efficient manger with good management style is regarded as an advantage in competition world. It's obvious that each organization requires an appropriate manager with good leadership style and best functionality.

The importance of management style and their function in organization is one of the main objects in policy making of each country.

Although managers can't achieve organizational objectives without using motivated and powerful human resource, wise and skillful management and leadership can solve problems of today's life.

Ability of manager to use facilities of organization to achieve its objectives can reflected understanding of society from that organization. Due to professional sensitivities and some benefits of management posts, their leadership styles and function is very important. This will improve organization and accelerates science and technology improvement. So, it's important to focus on sensitivity and importance of relation-oriented and standard oriented leadership style and their effect on teachers to improve human resources.

In another word, in educational environment such as schools, it should be enough notice on

creativity and its improvement in children, because the base of creative thinking is formed in first years of the life and shows the importance of educational system.

Studies of Abedi [1] showed that environments which require innovative and creative behaviors and reward its learners can lead to creativity in different educational areas. Educational systems should motivate individual in group and social level. It can be said that the role of educational system and teaching and training system, especially leadership style of managers and their attitude toward teachers, is effective in evolving creativity of managers.

Finally, because of importance of creativity and its relation with management style, educational managers should be initiative in choosing leadership styles in educational environment to improve creativity of teachers and education of learners.

Theoretical and practical definition of variables

This study deals with relation between leadership style of managers and creativity of teachers. Leadership style and creativity as independent and dependent variable, respectively, were discusses. Both variables are quantitative and integrated. Their theoretical and practical definitions are as follow:

Management style of managers

Theoretical definition: leadership style is leadership pattern of manager to lead activity of others and organization [2].

Practical definition: management style of managers is score acquired from Lutz's leadership style questionnaire.

Relation-oriented leadership style

Theoretical definition: this style focuses on characteristics, motivations and individual needs of employees in organization. It is based on the hypothesis that organization status depends on individuals working in organization than accurate performance of organization provisions and following organization expectations. It should not be considered that relation oriented style put less emphasize on organization objectives than standard oriented style, but in this style the most attention is on character and motivations of individuals. In this management style people are allowed to choose the best way of fulfilling tasks based on their own abilities [3].

Practical definition: score of relation oriented leadership style in this research is taken from Lutz leadership style questionnaire and using scores 3, 5, 8, 10, 15, 18, 19, 24, 26, 28, 30, 32, 34, and 35. It is considered as a quantitative variable and integrated with interval scales.

Standard oriented leadership style

Theoretical definition: relying on rules, the style focus on organizational expectations and is based on the hypothesis that to reach organization objectives organizational tasks should be combined with appropriate guides and rules and employees should be asked to do their tasks. In this style, organizational rules are defined in a way that each person can do their own tasks and achieve expected results. Subordinates are forced to obey rules and manager determines these rules [3].

Practical definition: score of standard oriented leadership in this style is taken from Lutz leadership style questionnaire and using scores 1, 2, 4, 6, 7, 9, 11, 12, 13, 14, 16, 17, 20, 21, 22, 23, 25, 27, 29, 31, and 33. It is considered as a quantitative variable and integrated with interval scales.

Creativity

Theoretical definition: a characteristic that is usually used to describe attitude. Important factors in defining creativity include flexibility in thinking, and undetermined thinking performance, but the most important think in creativity is initiation, initiation in solving a logic problem, a new process in chemistry, music, etc. From psychological view point, creativity is combination of new thinking using intuition of unknown resources [4].

Practical definition: score of creativity in this research is taken from Torrance creative thinking questionnaire and is discussed as a quantitative variable and integrated with interval scales.

In this research, relations, results and viewpoints of relation between leadership style of managers and

creativity of teachers are studied. Hence, managers and their leadership styles and the relation of these styles with creativity of managers are discussed. Leadership style of managers is relation-oriented and standard oriented. In relation oriented leadership style, managers focus on interpersonal and organizational relation, while in standard oriented leadership style, less focus is on human and interpersonal relations and mostly they rely on terms and conditions. In this research, relation between standard oriented and relation oriented leadership styles of managers and creativity of teachers are studied to determine if there is a meaningful relation between management style of managers and creativity of teachers.

Introduction to organization

Due to the expansion of societies and group life, people coordinate with each other to fulfill requirements and try to achieve their objectives. This coordination will cause formation of organizations; so organization is the born of group activities in which individuals gather together to achieve certain and common objectives. In addition to influence of a responsibility hierarchy, organizations use their mental, physical and material facilities to achieve a common objective to produce or serve needs of society [5].

Experts of organization science believe that to lead organizational activities and increasing its efficiency, some principles should be considered. Main principles include:

1. The principle of unity of purpose
2. The principle of unity of management
3. The principle of division of labor
4. The principle of flexibility
5. The principle of decision-making
6. The principle of coordination
7. The principle of hierarchy
8. The principle of field monitoring
9. The principle of discipline
10. The principle stability
11. The principle monitoring and evaluating
12. The principle authority and responsibility
13. The principle common responsibility of group.
14. The principle priority of public interests

It can be said the main important factors that mostly influence internal environment of organization are as follow:

1) Qualitative and quantitative features of human resources especially age, education, skill, marital status, etc. Complete recognition of human resources in organization is very important which is considered as weak or strength point of organization. Human resource capacities are case that is effective in determining or adjusting macro strategy of organization.

2) Type and nature of technology is one of the main factors in strategic decision making of production units. The importance of this factor in developing countries is more than developed countries because in these countries change or replacing new technology ensures costs but is influenced by foreign relations of the country.

3) Place of organization in life cycle is one of the main factors in organization. Organization behavior depends on level of organization life. Managers and employees of organizations have special situations based on management style and working morale. These characteristics are influenced by organization structure and organization culture, and affect structure and culture of organization. If these interactions won't be timely and appropriate, it will cause death of organization. Organizations have their own weak or strength according to their life cycle level.

Relation between management of human resources and level of organization life are classified in 5 levels:

a) Core of the activity is formed by idea of Entrepreneur manager.

b) In this level, areas of expertise grow, official structure of organization is formed and role of responsible or human resource manager emerges.

c) Level of organizational growth: In this level, expertise management role is emerged and highlights professional attitude toward human resource management.

d) Diversity of tasks necessitates focus and regional classification. In human resource management area employment, educational activities, welfare, rights and advantages coordinate with different parts of organization.

e) Called strategic integration, recommends flexibility in movements and coordination of organizational units. In this level strategic management of human resources is necessary.

4) Organization culture is general understanding of organizational situation by organization members. Organization culture is believes, norms, and dominated habits in organization that is formed in unconscious of employees and effect behavior of all employees. Norms and working habits of individuals in organization is sometimes constructive and sometimes preventive or destructive.

5) There are many definitions of organizational structure, one of which is about level of complexity and degree of centralization of options. Based on this definition, complexity of organization, centralization or decentralization of decisions on organizational relations, especially work division or formation of tasks and responsibilities and awareness of flexibility in organizational structure should be recognized [6].

Introduction to management

Management art is principle and scientific skills in lights of perception, insight and experience. Advocates of this view believe that working group, organizational condition and effective factors is very complex that makes control and predicting work results difficult. Complexity of management activities originates from psychological, sociological, cultural, economical and political issues. Solving problems in this complex situation necessitate insight, experience, conversance and scientific skills. Scientific methods are sometimes helpful and management theories also describe some complex aspects of organization, but management depends on situation and appropriate action. Scientific success in management depends on the fact that manager not only should have scientific knowledge, but be able to recognize how to use scientific knowledge in different situations and conditions.

Duties of managers

Management experts define duties of managers, especially managers who control affairs of macro organization, as set of actions and decisions to facilitate and coordinate work of other people. In this base, in macro organizations, macro group works in planning, coordinating and controlling, should be done. Manager has no more time to perform executive works, so, if management duties are defined as unexecuted performances, they can be classified according to Pour Sadegh [7]. The tasks include planning, organizing, staffing, leading, coordinating, reporting, and budgeting.

Duties of managers in teaching and training organization

If manager is defined as the source of organizational factors in coordinating accurate performance of plans, his duties can be known as complementary to main organizational principles. These duties, approved by many experts, are as follow:

- 1) Planning and designing teaching and training
- 2) Organizing
- 3) Predicting
- 4) Leading and managing
- 5) Creating morality
- 6) Accurate performance of requirements
- 7) Observing discipline of employees
- 8) Meeting and cooperation

Common approaches in management

In humanities and management science, using a theory or special approach, can express leadership style and performance of managers. Each theory and approach in humanities creates insights, limits and special ways.

Administrative management theory (classic theory of organization)

Among industrial managers and administrative officials who try to describe their knowledge, Henry Fayol is well known and his analysis of organization activity and management has stable effect on thinking area of management. He described management tasks and determined some principles on it.

Five function or management task include: planning, organizing, leadership, coordination and observing. Fayol believes planning and organizing is preparation to organizational operation. Coordination and observing is to evaluate real operation based on predetermined criteria.

Different types of leadership style

The way a leader uses his influence to achieve objectives is called leadership style. There are two management styles:

a) *Organization oriented style*: relying on organization, this style focuses on organization expectations and is based on the hypothesis that to achieve organizational objectives, different guidelines and orders can be combined with organizational duties and ask employees to follow the instruction. If the employees follow clearly defined instructions and organizational roles, organization can achieve its objectives.

b) *Human oriented style*: This style focuses on characteristics of human and individual needs and motives of employees. It's based on the hypothesis that status of organization mostly depend on its individual than accurate performance of organizational rules and obeying organizational expectations. It believes the best way to achieve organizational objectives is focusing on characteristic and motives of individuals. They let individuals to choose the best way to do their tasks based on their own capacities.

Leadership and behavior style of organization

Organization behavior is closely related to leadership style because occupational replacement and human capitals is related to leadership style. Leadership style has always negative relation with dismissal and absence from work and can create compatible and incompatible process of organizational behavior [7].

In another word, organization behavior increases tendency to group work, decreasing conflicts, significant increase of group power to solve problems and help to create motivational system based on findings and realities of psychology, etc. [8].

Introduction to creativity

Creativity is a mental process that is defined by creating new concepts or association among concepts or ideas. In one view, creative thinking is both innovative and proportional. Today's, creativity is creating a new thing. Although it seems a simple phenomenon, in fact it's very complex and is studied

in psychology, social psychology, artificial intelligence, philosophy, history, economic, etc. [1].

In last three decades, some experts try to have a comprehend definition of creativity. Guilford, after many researches, concluded that mental abilities of human can't be summarized in one aspect, and call it intelligence or something like that. Using developed statistic methods and computers, he found that intellectual forces of human can be divided into 150 separate factors, each can be measured separately. He believes some of these features are directly affecting creativity. These features include:

- 1) Fluency of stream of thought
- 2) Flexibility of intellectual forces
- 3) Originality of think and decision

Gilford believes these three features constitute divergent thinking or unusual thinking. People with divergent thinking are different in thinking and practice and are away of custom. Divergent thinking is scattering from a common place that is custom and tradition of society and convergent thinking is getting close to that point. Gilford believes creativity is divergent talent, offering objectives and new and unique solutions, new thinking and deviation from common believes.

Torrance [9], one of the founders of creativity in U.S., defines creativity as:

- Reviewing
- Rectifying errors
- Speaking and listening to a cat
- Entering to deep waters
- Exiting closed doors
- Connecting tuning fork to sun
- Eagerness to understanding
- Being happy
- Building exceptional palaces
- Welcoming to future [4].

Individual differences in creativity

Torrance [9], by preparing creative thinking tests based on intellectual test pattern, show that there are individual differences in creativity. Building on Guilford's work, Torrance developed the Torrance Tests of Creative Thinking in 1966. They involved simple tests of divergent thinking and other problem-solving skills, which were scored on Fluency, Originality and Elaboration. Creative thinking test of Torrance [10] is also a psychometrics research tool used widespread in this major. This test show appropriate reliability but average validity. In the other word, there is less correlation between scores of the test in children and teenagers and creativity in adults.

Creativity and academic progress

Many researches have been carried out to find relation between intellect and creation. Results of these studies show there is not much correlation between

score of the test taken from creativity evaluation tools. Torrance [9] measured average correlation between scores of IQ test and scores of creativity test in 187 researches as +0.20.

Relation between academic progress test scores and creativity test is not significant, so creative people can't be selected based on their academic scores. Furthermore, there is very little relation between classification of creative students and their scores. Torrance [10] reported that teachers are able to judge about creative abilities of their students and recognize them. Although there is little relation between academic progress and IQ scores, but it's not expected to find creative people among people with less intelligence.

Creativity theories

Undoubtedly, heritage, intellectual and socio-cultural factors are effective in talents and growth of creativity. It can be said that creativity is a talent taken from complex interaction of heritage and environment. Nowadays, psychologists have different ideas about role of training environment as effective factor in creativity.

Freud believes that conflict is the cause of creation of new thoughts. He believes as conflict causes protective behavior or unusual behavior, it has the main role is creating new ideas and thoughts. When physical tendencies or tendency to invasion and attack get away from conscious part of mind due to conflict with social norms, they enter unconscious part of mind and start activity. These activities emerge as practical or artistic activities. As whole, Freud believes that:

1. Conflict is source of creativity
2. Creative thinking is the best form of free imagination and plays of childhood
3. Creation of new thoughts and ideas is effective in decreasing stress of conflict
4. Creative people usually accept new thoughts and ideas, while unusual people never accept them
5. Childhood experiences are effective in creating new thoughts and ideas. These thoughts are continuation of those experiences or replace them.

Human theories on creativity mostly focus on positive aspect of human nature, his tendency to progress and development. Rogers believe that humans are naturally tended to grow and change positively. He defines the most important aspect of character as interaction between self and reality and between self and ideal self.

He believes all people with complete role and functionality, are creative, because with complete action can show more compatibility in serious changes of environment. These people are so creative that can cope with sever changes such as war or natural disasters, their behavior is spontaneous and in replying

strong stimulus of environment are changeable, expansible and thriving [11].

Some researchers use social view to measure creativity. Personality traits such as independency, self-confidence, attraction to complexity, aesthetic orientation, and risk accepting are used as scales of creativity.

REVIEW OF LITERATURE

In the research "Investigating Relation between Creativity, Emotional Intelligence and Self-Esteem" Mirzaee [12] found that there is a positive meaningful relation between creativity, emotional intelligence and self-esteem, increasing creativity will increase emotional intelligence and self-esteem and vice versa.

Khanlou [13] in his research "Investigating Relation between Leadership Styles and Personality Traits of Managers and Organizational Health" found a meaningful relation between human and cognitive leadership style and eccentric personality traits with organizational health. When a manager uses human and cognitive leadership style and is eccentric, his organizational health will increase.

Najafi [14], in his research "Investigating Relation between Thinking Methods of Managers and Their Functionality" found positive meaningful relation between divergent thinking method and duty oriented leader ship style. He also found meaningful relation between convergent thinking method and relation-oriented leadership style. Increasing divergent thinking method will increase technical leadership style and increasing convergent thinking method will increase human leadership style.

Lawrence and Lorsh [15], in their research on observing methods and organizational health, study observing methods in plastic, food and cartoon industry. They found a meaningful relation between organizational health and observing methods.

In a research on observing methods and their relation with functionality of employees and organizational health, Jeraldbell [16] found a meaningful relation between observing methods of managers and their functionality. Managers, who use organizational observing method, receive better functionality of their employees and save organizational health.

In his research "Investigating Relation between Creativity and Emotional Intelligence and Efficiency of Managers", Robinson [17] found a positive meaningful relation between creativity, emotional intelligence and efficiency of managers. Managers with high creativity have higher emotional intelligence in work environment and organization, and their efficiency is higher than managers with lower emotional intelligence.

Takmoora [18, 19] in his research on predicting creativity and emotional intelligence intellect found

that increasing intellect will increase emotional intelligence and creativity and vice versa and those with lower intelligence has lower emotional intelligence and creativity.

In the research "Investigating Leadership Style of Managers and Their Functionality in Ohio University", Grill [20], found that managers with divergent leadership style, have higher cognitive functionality and managers with convergent thinking, mostly use human functionality. Technical functionality has no meaningful relation with leadership style of managers.

In a research "Relation between Creativity and Leadership Style of Managers in Human, Cognitive and Technical Area" Lavan [21] found a meaningful relation between creativity and leadership style. Findings of the research show a positive meaningful relation between creativity and technical and cognitive leadership.

Karlo [22] in his research on relation between leadership styles and function of managers and creativity and personality traits, found a meaningful relation between leadership style and personality traits. He found a positive meaningful relation between standard oriented leadership style and creativity.

We concluded that manager and his management styles are the most important factors of each organization. If a manager wants to be successful, he should use the best leadership style to interest employees to work environment and strengthen motivation in all employees [23, 24].

Acknowledgements:

Support of Department of Education, Islamshahr Branch, Islamic Azad University, Islamshahr, Iran, is acknowledged.

Corresponding Author:

Homa Ghafourian,
PhD, Assistant Professor
Department of Education,
Islamshahr Branch, Islamic Azad University,
Islamshahr, Iran
E-mail: homaghafourian@yahoo.com

References:

1. Abedi, J (2000), Modern Approaches toward Creativity and its Evaluation, seasonal research journal, 3rd annual, vol. 37
2. Rezaeyan, A. (1993), Management Principals, Tehran, SAMT publication, 13th edition
3. Alvani, M (1997), General Management, Tehran, Ney publication
4. Qahramany, A. (2001), Investigating Relationship between Emotional Intelligence and Gender Role with General Health and Creativity, M.A. thesis, Islamic Azad University, Tehran Central Branch
5. Parhizgar, K. (1996), Management Theories, Tehran, Agah publication
6. Mir Sepasy, N (2001), Human Resource Management and Work Relation, Termeh publication
7. Pour Sadegh, M (1992), Organizational Behavior Management, Marine Training publication
8. Haghghi, M. A. (2001), Organizational Behavior Management, Termeh publication
9. Torrance, E.P. (1974). Torrance Tests of Creative Thinking. Scholastic Testing Service, Inc. http://en.wikipedia.org/wiki/Creativity#cite_ref-43.
10. Millar, G.W. (2007). E. Paul Torrance, "The Creativity Man": an Authorized Biography. ISBN 1-56750-165-6.
11. Shamlou, S. (2000), School and Theories of Character, Tehran, Roshd publication
12. Mirzaee, M (2003), Investigating Relation between Creativity and Emotional Intelligence and Self-Esteem, M. A. thesis, Islamic Azad University, Khorasgan Branch
13. Khanlou, M. R. (2005), Investigating Relation between Leadership Style and Personality Traits of Managers and Organizational Health, M. A. thesis, Islamic Azad University, Roudehen Branch
14. Najafi, R. (2006), Investigating Relation between Thinking Methods of Managers and their Function, M. A. thesis, Islamic Azad University, Roudehen Branch
15. Lawrence and Lorsh (1998), New Managerial Job, the Integrator, Harvard Business Review, 142-51
16. Jeraldbell (2001), Simplicity Cuts a New Pattern, management review
17. Robinson (2002), the Man with the Golden Touch, Inc, October
18. Takmoora (2003), Strategic Organization Design Glenview, III. Scot Foresman
19. Takmoora (2003), Prediction Creative and Emotional Intelligence by Intelligence, public: psychology, vol. 23
20. Grill, H. (2003), the Study Relation Thinking with Performance Manager, public: manager, vol: 34
21. Lavan, R (2004), the Relation Creative with Performance Destion, Public: Mc Growhill
22. Karlo, R. (2006), the Relation between Creative with Emotional Intelligence and Productivity Manager, Public: Mc Growhill.
23. Shafiezadeh. 2011. The prevalence of musculoskeletal disorders and its relationship to general health statement in hospital nurses. Life Science Journal, 8(4):409-415.
24. Leila Falahati, Laily Hj. Paim. 2011. Gender Differences in Financial Well-being, Financial Socialization and Financial Knowledge among College Students. Life Science Journal. 8(3):173-178.

9/12/2012

Aging populations' quality of life: An emerging priority for public health system in Iran

Jabbar Heydari¹, Samad Rouhani*², Reza Ali Mohammadpour³

¹. Department of Psychiatric Nursing, Mazandaran University of Medical Sciences, Sari, Iran

^{2*}. Assistant Professor, Department of Public Health, Faculty of Health; Psychiatry & Behavioral Sciences Research Center, Mazandaran University of Medical Sciences, Sari, Iran & Hospital Management Research Centre, Tehran University of Medical Sciences, Tehran, Iran

³. Associate professor, Department of Bio-statistics, Mazandaran University of Medical Sciences, Sari, Iran
samad.rouhani@gmail.com

Abstract: It is apparent that the biggest demographic and health transitions are related to aging population with an increase in the number of elderly people and disproportionate prevalence of chronic diseases with diminished quality of life (QOL). It is particularly important for policymakers and stakeholders to note that poor health is not an inevitable consequence of aging thus appropriate interventions are required. Because improving QOL is a major policy and lifestyle goal, understanding QOL has tremendous potential implications on designing social policies for well-being. In a cross-sectional study the QOL of 200 elderly people age above 60 were measured in Sari a typical city in Iran. SF-36 and GHQ-28 were used for data collection. The findings of this study have shown that the average QOL of elderly people is about 53.5%. More than half of respondents have found with possible mental illness. Those who were categorized with possible mental illness had statistically significantly lower QOL. Quality of life had significant relationship with both health and non-health related characteristics of respondents. It has concluded that mental health examination and support have high priority in improving and extending QOL of elderly people in Iran. A well coordinated program from all stakeholders with appropriate contribution of their role is recommended.

[Heydari J, Rouhani S, Mohammadpour RA. **Aging populations' quality of life: An emerging priority for public health system in Iran.** *Life Sci J* 2012;9(4):1304-1309] (ISSN:1097-8135). <http://www.lifesciencesite.com>. 197

Keywords: Aging, quality of life, priority, public health

1. Introduction

After decades that public health interventions and programmes have been successful in the control of communicable diseases and their threats, as major killers of patients particularly children and vulnerable groups, we have seen that life expectancy has increased more than three decades (Siegel and Doner, 2007). As a consequence the number of elderly people during recent years is increasing steadily particularly in developing countries such as Iran. Therefore, it is apparent that in these countries the biggest demographic and health transitions are related to aging population with an increase in the number of elderly people and change in the pattern of diseases. These changes are usually accompanied with an increase in demand for services that addresses non-communicable diseases (Minh et al., 2012). This indicates the shorter period to address the challenges of population aging, and thus, would require cost-effective use of limited available resources particularly in developing countries to meet the needs of older people (Momtaz et al., 2012). However, Iran still has a relatively young population and elderly population account something about 6% of its total population, but it is predicted that for coming decades it will increase rapidly (Mortazavi et al., 2012). For example, the proportion of elderly is

projected to double in less than 20 years (Jogataee, 2005). It has also been predicted that by the year 2050 when the number of country's population fail to double but the population of elderly age above 65 will increase six fold (Mehryar, 2004).

The rapidly increasing number of elderly people in developing countries like Iran will place unprecedented demands on aging services and the nation's entire health care system. This is now an area of concern for policymakers and top managers of public health system of these countries who should react to it appropriately (Heydari et al., 2012). In developed countries, it has been mentioned that the growth of health care expenditure is largely due to substantial increase in aging population. This is not only because of increase in number and length of life of aging population, but because of disproportionate prevalence of chronic diseases with diminished quality of life (QOL) that require appropriate interventions. Therefore, it is particularly important for policymakers and stakeholders to note that poor health is not an inevitable consequence of aging. Nowadays there exist different public health strategies that could help elderly people and improve the quality of their life (CDC, 2009). But the prerequisite of any intervention to serve elderly people is a better understanding of their situation. To

respond the requirement for a better life for elderly people, the results of (QOL) measurement has significant effects on designing social policies for well-being (Elosua, 2011; Rouhani et al., 2012). QOL is defined as “an individual’s perception of their position in life, in the context of the culture and value systems in which they live and in relation to their goals, expectations, standards and concerns.”(WHOQOL-Group, 1993). It has also been viewed as “an overall sense of well-being, when applied to an individual. It denotes a pleasant and supportive environment when it is applied to a community.”(U.S. Department of Health and Human Services, 1998). Nowadays, improving the QOL of this fastest growing population group has become a global priority for policy (WHO, 2002). The understanding, measurement, and improvement of human experience have been major goals of individuals, researchers, communities and governments. The overall assessment of human experience has been commonly expressed by the term QOL across multiple disciplines including psychology, medicine, economics, environmental science, and sociology (Costanza et al., 2007). QOL as a general term is meant to represent either how well human needs are met or the extent to which individuals or groups perceive satisfaction or dissatisfaction in various life domains. Understanding QOL has tremendous potential implications because improving QOL is a major policy and lifestyle goal (Schuessler and Fisher, 1985). Nowadays research and policy interest for measuring and enhancing quality of life of elderly people is growing internationally. The underlying factors for this interest is mainly due to increasing numbers of older people, higher expectations of a good life within society, and policy interest in the potential for reducing public expenditure (Brown et al., 2004; Herrera Ponce et al., 2011). Give Iran’s population transition with an expected substantial increase in the number of elderly people as mentioned earlier; information related to quality of life of elderly people is limited. The findings of this research could be useful in designing intervention studies that could eventually lead to application of strategies to promote QOL in elderly people in the region as well as other area with the similar socio-demographic and economic backgrounds.

2. Material and Methods

This was a cross-sectional study carried out in early 2012 in Sari a typical city in the north of Iran. It was a household survey that continued till reach to the required sample size of 200 elderly people in their home. All respondents from both sex groups who were over age 60 entered in this study.

Two questionnaire of health status measurement including SF-36 and GHQ-28 that their validity and reliability in the context of Iran were studied and confirmed before (Yaeghobi, 1995; Montazeri et al., 2005, Mohammadpour and Yosefi, 2008)), have been employed for measuring the quality of life and health situation of elderly people. GHQ-28 is usually used for studying mental health situation but SF-36 is a generic instrument for measuring quality of life. The score of quality of life measured by SF-36 is based on percentile that bigger percent represent for better quality of life. It has 8 subscales as different components of health related quality of life of individuals. They encompass Physical Functioning (PF), Role Physical (RP), Bodily Pain (BP), General Health (GH), Vitality (VT), Social Functioning (SF), Role Emotional (RE), and Mental health (MH) (Tajvar et al., 2008). But for GHQ-28 with 4 Likert scale as the 0 represent for no problem and 3 is the indication of worst situation, therefore, the highest the score observed the worse is the respondent's mental health status. The overall score of this instrument rank from 0 to 84. Also score 23 in this instrument is the cut-off point in which respondents with score above that level are categorised as individuals with possible mental health problems and people with score below that level are categorized as people with no mental illness. For this instrument, there are also 4 subscales including A (Biological Health), B (Anxiety), C (Social), D (Depression). On each component there are 8 questions therefore their scores rank between 0 to 24 for each component (Mokhtari and Ghasemi, 2010). Collected data were entered in excel program and with the use of SPSS software package and using correlation coefficient, independent samples t test and chi-squared test, variables of study were analysed.

3. Results

We have measured the quality of life and mental health status of 200 elderly people on their living place in urban area of Sari in Iran. In terms of socio-demographic characteristics, they had different background. Table 1 shows socio-demographic characteristics of participants of this study.

As table 1 indicates, elderly people participated in this study had relatively a mix socio-demographic background. Quality of life of respondents measured by SF-36 on average was 53.5% (S.D=19.4). Mental health status score of participants measured by GHQ-28 on average was 25.9 (S.D=10.6). Quality of life of respondents and their health status in terms of their mental health are presented in two following graphs.

Table 1: Socio-demographic characteristics of elderly people in Sari-Iran 2012

Socio-demographic characteristics		Number	Percent
Age	<70 years	90	45.0
	≥70 years	110	55.0
Gender	Male	78	39.0
	Female	122	61.0
Coupling	Couple	128	64.0
	Single	72	36.0
Education	Illiterate	73	36.5
	Literate	127	63.5
Job	Retired	115	57.5
	Others	85	42.5
Housing	Private	12	6.0
	Other	188	94.0
Medical insurance	Covered	17	8.5
	Uncovered	183	91.5

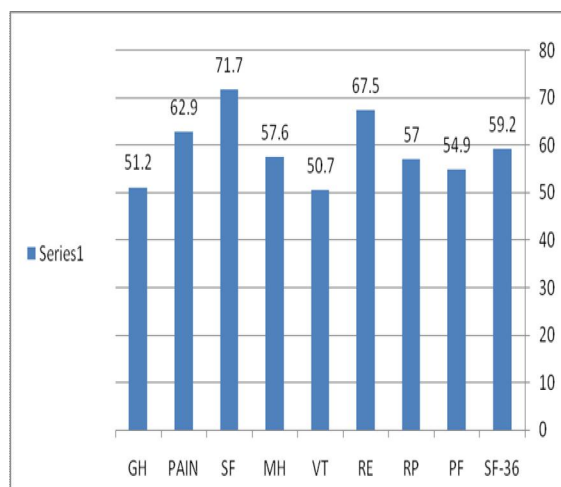

Graph 1. Quality of life of respondents (overall & dimensional) measured by SF-36 in Sari-Iran 2012.

As graph 1 depicts, average score of quality of life was 53.5% with lowest score on dimension VT (Vitality) and highest score on dimension SF (Social Functioning).

As graph 2 indicates, in overall the mean score of the mental health status was above the cut-off point 23 an indication of mental health problem of respondents. Respondents had better situation on dimension D (depression) while on other dimensions had almost similar status.

Further analysis on mean score of GHQ-28 has revealed that more than half of respondents (55.5%) were possibly mentally ill with mean score of 33.4 where the remaining had a mean score of 16.5.

Statistical analysis did not show any significant relationship between the score of GHQ-28

and those socio-economic variables presented in table 1. However there was statistically significant correlation between quality of life obtained by SF-36 and some of those indicators so that, better quality of life was observed among those elderly people who were in younger age ($P=0.01$), not retired ($P=0.007$), literate ($P=0.01$), and those with health insurance coverage ($P=0.01$).

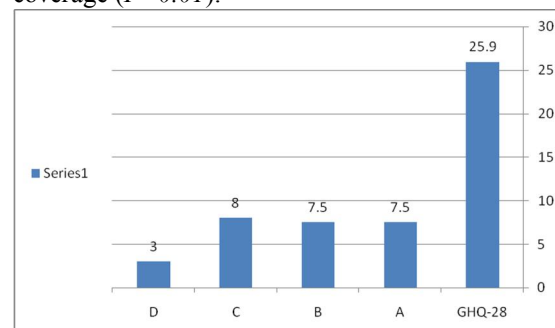

Graph 2. Mental health status of respondents (overall & dimensional) measured by GHQ-28 in Sari-Iran 2012.

Also there was statistically significant relationship between the mental health status of respondents and their quality of life ($P=0.000$) so that, the group who were recognised with mental problems had lower quality of life (on average 48.0%) compared to other group (mean score 59.2%). Overall and dimensional scores of quality of life and mental health status are compared in graph 3.

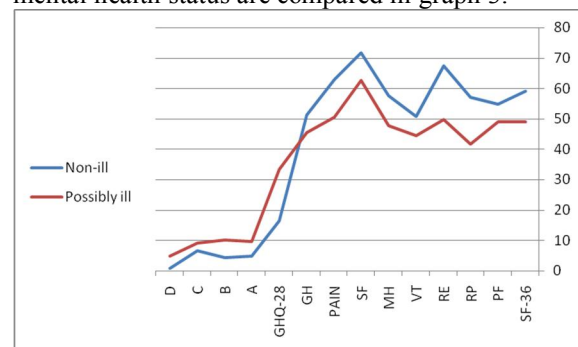

Graph 3. A comparison of mental health status and quality of life of possibly mentally ill and non-illness participants in Sari-Iran 2012.

As the above graph shows, not only total score of respondents measured by both instruments were quite different, but also on different components of each questionnaire they had the same situation. Statistical analysis has shown that except on one dimension of SF-36 (PF or Physical Functioning), on all other components, the difference between two groups was statistically significant ($P \leq 0.05$). Analysis on the scores of items of instruments also was performed that is presented in table 2.

Table 2: Correlation between scores (overall & dimensional) measured by two instruments (presented by 'r' & 'p value' in Sari-Iran 2012)

Variables/ 'r' & 'p value'	GHQ-28	A	B	C	D
SF-36	-.054 .000	-.236 .001	-.222 .001	-.158 .025	-.144 .034
PF	-.048 .499	-.134 .058	-.089 .209	-.006 .930	.100 .158
RP	-.169 .017	-.117 .100	-.148 .037	-.106 .137	-.137 .053
RE	-.188 .008	-.130 .067	-.189 .007	-.069 .335	-.163 .021
VT	-.233 .001	-.197 .005	-.208 .003	-.106 .135	-.173 .015
MH	-.349 .000	-.253 .000	-.339 .000	-.196 .005	-.253 .000
SF	-.139 .049	-.194 .006	-.067 .344	-.105 .141	-.057 .421
PAIN	-.257 .000	-.262 .000	-.187 .008	-.273 .000	-.080 .261
GH	-.255 .001	-.223 .002	-.152 .032	-.160 .023	-.145 .040

As table above reveals, in the majority of cases there were a significant correlation between scores measured by SF-36 and GHQ-28. In terms of overall scores the strongest correlation (negative) was between total score of GHQ-28 and mental health (MH) of respondents measured by SF-36 ($r=0.4$).

4. Discussions

Based on the finding of this research, the majority (55.5%) of elderly people who have participated in this study had possibly mentally illness. Expectedly the quality of life of this group was significantly lower than the other group. Also, as indicated in table 2, the strongest correlation between score obtained by GHQ-28 as an indication of mental health status and components of SF-36 was related to MH or mental health of respondents that is in the line with the finding of other authors (Failde et al., 2000). Therefore we can more confidently rely on the mental health situation of participants as being categorised. This situation indicates that appropriate intervention is required both for the treatment of elderly people's mental illness and for the improvement of their quality of life. In the other words in the case of Iran, it needs to be emphasised that not only the increasing number of elderly people as discussed earlier is an area of concern, but also taking the mental health statuses of these population into account, adds the importance of appropriate interventions to change the situation. Although the overall quality of life elderly people in this study is low, they are more weak on the item of VT (vitality and happiness) the item that could be an indication of all aspects of their life either related to health or other features of their living conditions (Anastasia et al., 2003; Wagert et al., 2005; Fagerström et al., 2007).

Being vital, energetic and happy is not only related to other conditions of an individual's life but also can affect other dimensions of quality of life positively and result to a better level of life satisfaction as discussed by Beyaztas et al., 2012. The score of quality of life obtained in this study (53.5) is close to the finding of another study (Aghanori et al., 2012) that reported the quality of life of elderly people 55.7 in other part of the country. They have concluded gender and lack of recreational facilities as important factors affecting quality of life of elderly people. However the mental health status of elderly people in our study was not associated with socio-demographic variables, but quality of life of studied population has statistically significant relationship with some of those characteristics including age, education, job, and insurance coverage. Therefore quality of life of respondents was not only associated with their mental health situation, but also with some of non-health related factors. Tajvar et al., 2008, have found age, gender, education and economic status as determinants of poor quality of life of elderly people in Tehran. Correlation between quality of life of elderly people and socio-demographic factors was also found in different studies in Iran (Abbasimoghadam et al., 2009; Tajvar et al., 2008; Vahdaninia et al., 2005; Rafati et al., 2004; Bazrafshan et al., 2008). Such finding was reported in both developed and developing countries as well. For instance in China (Qin, 2007) the author found that subjective quality of life of elderly people is related to both health and socio-cultural factors. Minh et al., (2010) in their study have found an association between socio-economic background and quality of life of older adults in rural area of Vietnam and Indonesia. In another study conducted among elderly people in US and Canada, it has been found that household income was associated with quality of life of elderly people in US but not in Canada (Huguet et al., 2008). Rodrigo et al., (2007) have found a negative correlation between stress and quality of life of elderly people in Nebraska. Netuveli and Blane, (2008) mentioned dementia and depression as major factors affecting the quality of life of elderly people. Our findings are potentially useful for policymakers and decision makers, as pointed out by other authors, (Qin, 2007; Brown et al., 2004; Herrera Ponce et al., 2011), to understand that for helping elderly people and promoting their quality of life interventions must have a broader base and include other aspect of their daily life particularly their happiness and life satisfaction rather than a narrow perspective of health services. Such multifaceted interventions and programs require a good inter and intra-sectoral cooperation of related regional and national organisations. The thing that is usually rare in

developing countries particularly in Iran. Researchers on their interventional study of helping elderly people's quality of life in Tehran (Mortazavi et al., 2012) have found that physical activity has significant impact on mental health and then on the quality of life of elderly people. Where providing opportunities for physical activities of elderly people such as walking programmes, jogging, and some age specific exercises seems to be quite possible in any country, but it is not very common among elderly people in Iran. Given the importance of physical activity on all aspects of health and well-being of elderly people more effort need to put in place to change the situation.

5. Conclusion

Quality of life of elderly people in the studied population is low. Low level quality of life of elderly people is associated with both health and non-health related factors. However, elderly people's quality of life was associated with both health and non-health related factors i.e. mental health and socio-demographic characteristics, but mental health of these people was not significantly different across different socio-demographic group. This means elderly people of all socio-demographic groups should be considered as candidate for mental health examination and assisted with appropriate mental health support. This could be a priority for public health system in Iran to invest more on mental health issues of elderly people in its entire primary health care network. Based on the finding of this research and existing literature, it is apparent that the quality of life of elderly people in Iran needs major improvement. It means adding life to years of elderly people and making their life with vitality and happiness is quite obvious. Improving the quality of life of elderly people and bringing vitality and satisfaction to their life require both social and health interventions. This demands a well coordinated program of all stakeholders with appropriate contribution of their role. Therefore, regional and national level organisations require investing more in this area of health as well as social services to help this vulnerable population. Appropriate attention should be paid to social programmes and services such recreational facilities and networking. Improving life satisfaction and happiness seems to be in the highest priority in improving quality of life of elderly people in Iran.

Acknowledgements:

Foundation item: The research project of Mazandaran university of medical sciences (No.: 90148) . Authors tank Mazandaran University of medical sciences for the approval and financial support of this study. Also we appreciate the

collaboration of all patients who had participated in this study.

Corresponding Author:

Dr. Samad Rouhani

Assistant Professor, Department of Public Health, Faculty of Health; Psychiatry & Behavioral Sciences Research Center, Mazandaran University of Medical Sciences, Sari, Iran & Hospital Management Research Centre, Tehran University of Medical Sciences, Tehran, Iran

E-mail: samad.rouhani@gmail.com

References

1. Abbasimoghadam, M.A., Dabiran, S., Safdari, R., Djafarian, K. Quality of life and its relation to socio-demographic factors among elderly people living in Tehran. *Geriatr Gerontol Int*. 2009; 9(3): 270-5.
2. Aghanori, A., Mahmoodi, M., Salehi, H., Jaeferian, K. Assessing quality of life of elderly people covered by health centers of urban area in Markazy province, Iran in 2011, *Salmand Iranian Journal of Ageing*, 2012; 22 (6): 20-29.
3. Anastasia, E., Maria, K., Grace, C. Subjective quality of life in old age in Greece: The effect of demographic factors, emotional state and adaptation to aging. *Eur Psychologist*. 2003; 8: 178-91.
4. Bazrafshan, M.R., Hosseini, M.A., Rahgozar, M., Sadat Maddah, S.B. Quality of elderly's life in Shiraz, Jahandidegan club. *Salmand Iranian Journal of Ageing*. 2008; 3(7): 33-41.
5. Beyaztas, F.Y., Kurt, G., Bolayir, E. Life satisfaction level of elderly people: a field study in Sivas, Turkey. *J Pak Med Assoc*. 2012; 62 (3): 221-225.
6. Brown, J., Bowling, A., Flynn, T. *Models of Quality of Life: A Taxonomy, Overview and Systematic Review of the Literature*. European Forum on Population Ageing Research. 2004.
7. CDC. Healthy aging, improving and extending quality of life among older Americans: At a glance. National center for chronic disease prevention and health promotion. 2009. <http://www.cdc.gov/aging>
8. Costanza, R. et al., Quality of life: An approach integrating opportunities, human needs, and subjective well-being. *Ecological Economics*. 2007; 61: 267-276.
9. Elosua, P. Subjective values of quality of life dimensions in elderly people. A SEM preference model approach. *Soc Indic Res*. 2011; 104: 427-437. DOI 10.1007/s11205-010-9752-y
10. Fagerström, C., Holst, G., Hallberg, I. R. Feeling indered by health problems and functional capacity at 60 years and above. *Arch Gerontol Geriatr*. 2007; 44: 181-201.
11. Failde, I., Ramos, I., Fernandez-Palacin, F. Comparison between the GHQ-28 and SF-36 (MH 1-5) for the assessment of the mental health in

- patients with ischemic heart disease. *European Journal of Epidemiology*. 2000; 16(4): 311-316.
12. Heydari, J., Khani, S., Shahhosseini, Z. Health-related quality of life of elderly living in nursing home and homes in a district of Iran: Implications for policy makers. 2012. *Indian Journal of Science and Technology*. 2012; 5(5): 2520-2525.
 13. Herrera Ponce, M. S., Barros Lezaeta, C., Fernández Lorca, M.B. Predictors of quality of life in old age: A multivariate study in Chile. *Population Ageing*. 2011; DOI 10.1007/s12062-011-9043-7.
 14. Huguet, N., Mark S. Kaplan, M. S., Feeny, D. Socioeconomic status and health-related quality of life among elderly people: Results from the Joint Canada/United States Survey of Health, *Social Science & Medicine*. 2008; 66: 803-810.
 15. Jogataee M: The Elderly World Day. *Monthly Magazine of University of Social Welfare and Rehabilitation Science*. 2005; 11: 2.
 16. Mehryar, A. H., Ahmad-Nia, S. Age-structural transition in Iran: short and long term consequences of drastic fertility swings during the final decades of twentieth century. CICRED Seminar. Paris, 23-26 February 2004. Available at: <http://www.cicred.org/Eng/Seminars/Details/Seminars/Popwaves/PopwavesMehryarAhmad-Nia.pdf>
 17. Mohammadpour, A. R., Yousefi, Z. Factor analysis of SF-36 Persian version Health-Related Quality of Life questionnaire in Iran. *World Applied Science Journal*. 2008; 3(4): 548-554.
 18. Minh, H.V., Ng, N., Byass, P., Wall, S. Patterns of subjective quality of life among older adults in rural Vietnam and Indonesia. *Geriatr Gerontol Int*. 2012; 12: 397-404.
 19. Mokhtari, F., Ghasemi, N. Comparison between mental health and quality of life of elderly people resident and non-resident in elderly home, *Salmand Iranian Journal of Ageing*, 2010; 18(5):53-63
 20. Momtaz, Y. A., Hamid, T. A., Ibrahim, R. Unmet needs among disabled elderly Malaysians. *Social Science & Medicine*. 2012; 75: 859-863.
 21. Montazeri, A., Goshtasebi, A., Vahdaninia, M., Gandek, B. The Short Form Health Survey (SF-36): translation and validation study of the Iranian version. *Qual Life Res*. 2005; 14(3): 875-82.
 22. Mortazavi, S. S., Mohammad, K., Ardebili, H. E., Beni, R. D., Mahmoodi, M., Keshteli, A. H. Mental disorder prevention and physical activity in Iranian elderly. *Int J Prev Med*. 2012 March; 3(Suppl1): S64-S72. PMID:PMC339931.
 23. Netuveli, G. Blane, D. Quality of life in older ages. (2008). *British Medical Bulletin*. 2008; 85: 113-126 DOI:10.1093/bmb/ldn003
 24. Qin, Huali, "Adding Life to Years: Predicting Subjective Quality of Life among Chinese Oldest-Old" (2007). *Gerontology Theses*. Paper4. http://digitalarchive.gsu.edu/gerontology_theses/4
 25. Rafati, N., Mehrabi, Y., Montazeri, A. Quality of life among Kahrizak charity institutionalized elderly people. *Journal of School of Public Health And Institute of Public Health Researches* 2004;2(3): 67-76.
 26. Rodrigo, R., Potter, J. J., Leach, C. K. "Perceptions of Quality of Life, Sense of Community, and Life Satisfaction among Elderly Residents in Schuyler and Crete, Nebraska" (2007). *Architecture Program: Faculty Scholarly and Creative Activity*. Paper4. http://digitalcommons.unl.edu/arch_facultyschol/4
 27. Rouhani, S., Kheirkhah, F., Salarieh, I., Abedi, S. Quality of life, its early change and retention in MMT program in Iran: Evidence for policymakers and service providers. *Life Science Journal*. 2012; 9(3):2633-2638
 28. Schuessler, K.F., Fisher, G.A. Quality of life research and sociology. *Annual Review of Sociology*. 1985; 11: 129-149.
 29. Siegel, M., Doner, L. L. Marketing public health: strategies to promote social change, Second Edition. Jones and Bartlett Publications. Boston. USA. 2007.
 30. Tajvar, M., Arab, M., Montazeri, A. Determinants of health-related quality of life in elderly in Tehran, Iran. *BMC Public Health*. 2008; 8(1): 323.
 31. U.S. Department of Health and Human Services. *Healthy People. 2010*. Washington, DC: U.S. Government Printing Office. 1998.
 32. Vahdaninia, M.S., Gashtasbi, A., Montazeri, A., Mafton, F. Health quality of life in elderly: population based survey. *Payesh Health Monitor*. 2005; 4: 113-120.
 33. Wagert, P.H., Ronnmark, B., Rosendahl, E., Lundin-Olsson, L., Gustavsson, J. M., Nygren, B. Morale in the oldest old: the Umea 85+study. *Age Ageing*. 2005; 34: 249-55.
 34. WHOQOL-Group. Study protocol for the World Health Organization project to develop a Quality of Life assessment instrument (the WHOQOL). *Q Life Res*. 1993; 2: 153-159.
 35. World Health Organization. *Active Aging: A Policy Framework*. Geneva: World Health Organization, 2002.
 36. Yaeghobi, N. Epidemiology of mental disorder in urban and rural area of Somehsara. *Quarterly Journal of Thinking and Behavior (Andisheh Va Rftar)*. 1995; 1(4):381-389.

9/6/2012

Seasonal variation in the incidence of preeclampsia based on the time of conceptionFariba Nanbakhsh¹, Farzane Broomand¹, Hamideh Mohaddesi^{*2}, Samieh Nefoozi³, Pouya Mazloomi³

1. Department of Obstetrics and Gynecology, Urmia University of Medical Sciences, Urmia, Iran
 2. Midwifery Faculty, Midwifery Department, School of Nursing and Midwifery, Urmia University
 3. General Practitioner, Urmia University of Medical Sciences, Urmia, Iran
- hmo-haddesi.han@gmail.com

Abstract: Approximately 3-8% of pregnancies are complicated by preeclampsia (PE) and complications of pregnancy-related hypertensive disorders that are the third leading cause of maternal deaths. This study was conducted to assess the incidence of preeclampsia in women based on month and season of the conception in northwestern Iran. The present investigation is a descriptive analytic cross-sectional study including all pregnant women with singleton pregnancies admitted to the Urmia Medical Science University due to preeclampsia, 2007-2008. From 2824 women with singleton pregnancy, 166 of them had preeclampsia and 2658 did not. In all cases, the onset of pregnancy was determined and the relationship between month (season) of pregnancy and occurrence of preeclampsia was studied. The general information, primary characteristics, and the history of the two groups were collected and compared. The age, gravidity and parity in the affected group were lower and difference was statically significant. Being nulligravid and having previous abortion was higher in the case group; and the difference was not statically significant. Preeclampsia incidence increased in cases of conception in warm and hot season's esp. in summer. The average temperature of conception is higher in women with preeclampsia but the difference is not statically significant. Therefore, it is suggested to hold training classes for young couples in order to avoid such disorders.

[Fariba Nanbakhsh, Farzane Broomand, Hamideh Mohaddesi, Samieh Nefoozi, Pouya Mazloomi. **Seasonal variation in the incidence of preeclampsia based on the time of conception.** *Life Sci J* 2012;9(4):1310-1314] (ISSN:1097-8135). <http://www.lifesciencesite.com>. 198

Keywords: Seasonal variation; incidence of preeclampsia; timing of conception; northwestern Iran

1. Introduction

Preeclampsia (PE) is a multisystem disorder of pregnancy characterized by the presence of clinical signs including proteinuria (300 mg or greater in a 24-h urine specimen and/ or protein to creatinine ratio of >0.30) and hypertension (defined as systolic blood pressure P140 mm Hg or diastolic blood pressure P90 mm Hg) (Wellington and Mulla, 2012. Harapan et al., 2012), that develops after 20 weeks of gestation. It has been estimated that PE affects 3–5% of pregnancies worldwide recently, it has been reported that PE complicates 3–8% of pregnancies PE increases the maternal and fetal complication (Scott et al., 2003). It accounts for approximately 50,000 maternal deaths worldwide each year (Soroori et al., 2007).

In the USA, approximately 5–7% of pregnancies are complicated by PE and complications of pregnancy-related hypertensive disease, which are the third leading cause of maternal deaths (Wellington and Mulla, 2012. Cunningham et al 2010).

Infantile outcome of PE pregnancies depends chiefly on the age of gestation in delivery and on the severity of the disease (Scott et al., 2003).

Early diagnosis and close observation of women with PE is vital since the risk of placental abruption, acute renal failure, cerebrovascular and cardiovascular complications, disseminated

intravascular coagulation, and even maternal death increases (Wellington and Mulla, 2012).

Some well established risk factors for PE include nulliparity diabetes mellitus, nephropathy, collagen vascular disease, antiphospholipid antibody syndrome, molar pregnancy, fetal hydrops, multiple-pregnancy, positive history of chronic hypertension, obesity, maternal infection, positive family history of PE, and fatal aneuploidy (Cunningham, et al, 2010., Phillips, et al 2004), However the main etiology of PE is not clear, smoking has been found to decrease the risk of PE among underweight and normal-weight women but not in overweight women (Scott et al., 2003).

As many hypotheses have emerged to offer a causal framework for the disease, PE has been named the 'disease of theories' (Wellington and Mulla, 2012). Although there is no definitive answer for the cause or causes of PE, some basic causes may be genetic predisposition, thrombophilia, functional radiation in prostaglandin, endothelial injury, change in amount of nitric oxide (NO), increasing free radicals, abnormal invasion of erythroblasts, abnormal metabolism of calcium, or nutrition deficiencies (Scott et al., 2003).

Because the main etiology is unclear and the theories about mechanisms and preventive factors in high risk patients are not completely proven and their

application is not desirably effective, so seeking unknown factors, like the season of conception, which affect the occurrence of PE is of importance.

Phillips, et al studied the relation between seasonal variations in PE based on timing of conception. The goal of this study was to assess the occurrence of PE and its relationships with month and season occurrence of the conception. In this study 142 women affected by PE were studied. The results showed that the conception in summer significantly increases the risk of PE Phillips, et al (2004). In case the relationship is strong, conception could be avoided specially in high risk women (Refsum et al 2004). They found the highest risk of PE in conceptions occurring in the summer, whereas there was no significant variation in the incidence of PE based on the timing of delivery.

In Ghana, more cases of eclampsia have been noted in the rainy season. However; there are some studies that show no significant correlation between seasonal change and PE (Phillips, et al 2004).

If there is a relationship between PE and the season of the conception, it is possible to avoid the pregnancy of women in the risk. This study was conducted to find the seasonal variation on the incidence of PE.

2. Material and Methods

The present investigation is a cross-sectional descriptive and analytic study including all pregnant women with singleton pregnancies admitted to the Urmia Medical Science University, I.R.IRAN (Motahhari hospital) due to PE in a one year period, March 21, 2007 to March 21, 2008. Their pregnancies were term (equal to or more than 37 weeks, ≥ 37 weeks) as defined by the American college of obstetricians and Gynaecologists (ACOG). Women with multiple pregnancies, positive history of coagulative disease and anti phospholipids syndrome, history of chronic hyper tension, or chronic renal disease, and patients with incomplete records were excluded. The records of the study cases were assessed for the parameters of inclusion criteria and exclusion criteria then month and season of conception based and the age of pregnancy was calculated by LMP. This time was entered to the questioner and was studied. The registered information was parity, maternal age, date of birth, occurrence of hypertension (BP-140.90), PE (BP-140.90, and 1+ proteinuria dipstick or more than 300 mg protein in a 24-hour urine analysis) and eclampsia (PE and convulsion). In this study 2824 women with singleton pregnancy were enrolled due to the criteria which 166 of the contracted PE and 2658 did not. T-test, fisher, chi square test were used. The collected data were analyzed by SPSS 16. P value under 0.05 ($p < 0.05$) was considered statistically significant.

3. Results

This study enrolled 2824 women with singleton pregnancies, 166 of them were affected by PE and 2658 were devoid of it. The general information, primary characteristics, and history of the two groups are indicated in the tables 1 and 2. The items of the two groups were compared. The age, gravidity and parity in the affected group were lower and difference was statically significant. Being nulligravid and having previous abortion was higher in the case group; and the difference was not statically significant. In this study the incidence of PE in women based on month and season of the conception was assessed. The frequency percent of PE began to increase from April to reach its peak in August. Then it decreased until March. However the difference was not statically significant ($p=0.243$) (Table 3 and Figure 1). The frequency percent of conception in the summer of the case group and conception in the autumn and winter of the control group was higher and the difference was statically significant ($p < 0.04$). The conception in spring lacked significant difference (table 4 and Figure 2) also the frequency percent of conceptions in warm seasons (spring and summer) for the case group and conception in cold seasons (Autumn and winter) for the control group was higher and the difference was statically significant ($p=0.038$).

4. Discussions

This study assessed the relation between the incidence of PE and conception time. The ultimate result indicated significantly higher occurrence in warm season's esp. in the summer. In particular, few studies have assessed this relation: Phillips and et al. (2004) conducted a study in USA enrolling 142 primipar women with singleton pregnancy which were afflicted with PE and compared their conception time with 7762 primipara women with singleton pregnancies lacking the condition. This study showed the conceptions in summer and in June, August has the highest risk and in March has the lowest risk of PE. This relation was not dependant to other risk factors such as low age of mother. (Phillips, et al. 2004) in another study conducted is USA by Rudra and et al. (2005) 6680 cases of PE were included and their conception time was compared with unaffected cases. The study showed that conceptions in warm seasons (spring and summer) results in the highest risk and conceptions in cold was independent of other risk factors of PE (Bernstein et al. 1998). In another study by Tam and et al (2008) conducted in Hong Kong, 245 women affected by PE were assessed. In this study once more conception in summer (especially in June) accompanied the highest risk of PE. The occurrence of PE in cold seasons was the least (Tam et al 2008). Abbassalazadeh and et al. (2007) assessed 99 women

suffering from PE in comparison with 1917 control in Tabriz, Iran. The study concluded that the conception time in July and October is directly and significantly related to the incident of PE (Abbasssalizadeh et al. 2007). Neela and et al supported the speculated relationship between increasing humidity and a lower temperature range with the increased incidence of eclampsia (Neela et al.2007).

PE is significantly more common in the Jewish population. However, both populations demonstrate the same seasonal pattern, with higher incidence of PE in the winter months.

In result suggest that climate and environmental exposure may have an important role in the pathophysiology of PE (Shental et al.2010). The seasonal distribution reveals that the incidence of PE is significantly higher during the dry season than during the rainy season, but probably is not directly related to meteorological factors but rather on the nutritional deficiencies caused by the low rate of precipitations (Elongi et al, 2011). Seasonal variation was minimal with the lowest prevalence detected in the fall (3.89%) and a peak of 4.1% in the winter. The highest monthly prevalence was found in January (4.4%). After adjusting for maternal age, race, and other potential confounders, women who were admitted in the fall for delivery were 6% less likely than women who were admitted in the winter to have PE : adjusted OR = 0.94, 95% CI: 0.89-0.99 (P = 0.02). (Wellington and Mulla, 2012)

The findings have implications for future research related to the aetiology of pre-eclampsia as well as for clinical care (Immink et al.2008).

Khojasteh and et al. (2012) found a relationship between the number of PE incidence and season. Therefore, precautions should be considered in those seasons in which the PE is increased. Attention to this prenatal care centers may help to decrease such serious side effects that endanger the health of both mother and fetus (Khojasteh and et al. 2012).

As it is evident our results are in agreement with the results of other studies. Discovering seasonal variation of PE occurrence seems an ancient subject. Antique books indicate that Hippocrates was attentive to this relation at the first place. After 1756 Smalliean et al. assessed and presented the variation of PE occurrence due to season, temperature, and rainfall amount, also, Chesly and et al. (1984) showed that conceptions in June is more probable to result in pregnancy complicated by PE (Chesly et al. 1984).

They explained that more weddings in this month and higher probability of primigravid pregnancies account for this fact (Khojasteh et al 2012), however, the main aetiology of the seasonal variation PE occurrence is not known properly. Some studies justification of the higher occurrence of PE in warm

seasons (decreased plasma Volume in early times of pregnancy) (Refsum et al 2004. Van Beek et al, 1998. Silver et al 1998. Spaanderman et al, 2001. Aardenburg et al, 2003. Kristal-Boneh et al, 1997. Shapiro, 1981. Morimoto et al, 1974) variation in temperature and humidity are other mechanisms that have been suggested (Phillips et al, 2004. Tam et al 2008. Subramaniam, 2007) circadian cycle change is another probable cause for this relation. The change has been introduced as reduced sunshine, and subsequent decrease in vitamin D synthesis which result in altered calcium metabolism (Levine et al, 1997. Taufield et al, 1987. Zemel et al, 1990). Some studies have proposed variation in nutritional habits such as quantity of antioxidant intake in different seasons of year (Salvig et al, 1996. Chappell et al, 1999. Rajkovic et al 1997).

The relation between delivery time and PE incidence were assessed in different studies and controversial results have been reported: some studies showed delivery in warm seasons increased the risk of PE (Tam et al,2008. Subramanian, 2007).

Some other studies showed the same relation for cold seasons. This class of studies possess an outstanding percentage (6.7). In other studies (two studies in Kerman, Iran and Tehran, Iran) no such relation was found (Aali and Janghorbani, 1996). Considering the result of studies which indicate higher incidence of PE, it could be estimated that conceptions in warm seasons would increase the incidence of PE. Even though many of these patients deliver in preterm and estimating their conception date would be inaccurate (Phillips et al 2004). However, it can be proposed that PE occurrence is a multifactor event and seasonal variation could have a role in it. Ultimately, the interaction of different involved factors would be determining. Our study shows the obvious (apparent) trend which is independent of other influencing parameters.

The trend indicates higher PE occurrence in conceptions of warm seasons and gradually decreases afterwards.

5. Conclusion:

PE incidence increases in cases of conception in warm seasons and summer in particular. The average temperature of conception is higher in PE cases but the difference is not statically significant. Therefore, it is suggested to hold training classes for young couples in order to avoid such disorders.

Acknowledgments:

The authors wish to thank the colleagues and patients that were kindly engaged and collaborated with us throughout this study.

Corresponding Author:

Dr. Hamide Mohaddesi

Department of Obstetrics and Gynecology, Urmia,
University of Medical Sciences, Urmia, IranE-mail: hmohaddesi.han@gmail.com**References**

- Wellington, K., Mulla, Z.D., Seasonal trend in the occurrence of preeclampsia and eclampsia in texas. *Am J Hypertens* 2012; 25 (1): 115-19.
- Harapan H, Andalas M, Mudhakir D. Micro RNA: New aspect in pathobiology of preeclampsia. *Egypt J Med Hum Gen* 2012; 13: 127-31.
- Scott JR, Disaia PJ, Haney F. Danforth's Obstetrics & Gynecology 2003, Vol 1, 9th ed. Lippincott Williams & Wilkins, USA.
- Soroori ZZ, Sharami SH, Faraji R. Seasonal variation of the onset of preeclampsia and eclampsia. *J Res Med Sci* 2007;12 (4): 198-202.
- Cunningham FG, Gant NF, Leveno KJ, Gilstrap LC, Hauth JC. Williams obstetrics. 22nd ed. McGraw Hill, USA, 2010.
- James DK, Steer PJ, Weiner CP, Gonik B. High risk pregnancy: management options. 3rd ed. Chapman Publication, London, 2005.
- Phillips JK, Bernstein IM, Mongeon JA, Badger GJ. Seasonal variation in preeclampsia-based on timing of conception. *Obstet Gynecol* 2004;104 (5 I): 1015-20.
- Refsum H, Smith AD, Ueland PM, Nexø E, Clarke R, McPartlin J, Johnston C, Engbaek F, Schneede J, McPartlin C, Scott JM. Facts and recommendations about total Homocystine determinations: an expert opinion. *Clin Chem* 2004; 50(1): 3-32.
- Bernstein IM, Meyer MC, Osol G, Ward K. Intolerance to volume expansion: a theorized mechanism for the development of preeclampsia. *Obstet* 1998;92(2):306-8.
- Tam WH, Sahota DS, Lau TK., Li CY, Fung TY. Seasonal variation in pre-eclamptic rate and its association with the ambient temperature and humidity in early pregnancy. *Gyn Obs Investig* 2008;66 (1): 22-6.
- Abasalizade Sh, Abbasalizade S. Is seasonal variation effective on preeclampsia? Tehran: Congress on gynecologic Diseases, 2007.
- Raman NJ. Seasonal trends in the occurrence of eclampsia. *Natl Med J India* 1993; 6(1):17-18.
- Shental O, Friger M, Sheiner E. Ethnic differences in the monthly variation of preeclampsia among Bedouin and Jewish parturients in the Negev. *Hypertens Pregnancy* 2010; 29(3):342-9.
- Elongi JP, Tandu B, Spitz B, Verdonck F. Influence of the seasonal variation on the prevalence of pre-eclampsia in Kinshasa. *Gynecologie Obstetrique Fertilité* 2011; 39(3):132-5.
- Immink A, Scherjon S, Wolterbeek R, Steyn DW. Seasonal influence on the admittance of pre-eclampsia patients in Tygerberg hospital. *Acta Obstetrica Gynecologica Scandinavica* 2008; 87(1):36-42.
- Khojasteh F, Safarzadeh A, Borayri T, Baghban K. Survey of correlation between preeclampsia and season & some of its risk factor in pregnant. *J Women Health Care* 2012; 1:3.
- Chesley LC. History and epidemiology of preeclampsia-eclampsia. *Clin Obstet Gynecol* 1984; 27(4):801-20.
- Van Beek E, Ekhart TH, Schiffers PM, van Eyck J, Peeters LL, de Leeuw PW. Persistent abnormalities in plasma volume and renal hemodynamics in patients with a history of preeclampsia. *Am J Obstet Gynecol* 1998; 179(3 Pt 1):690-6.
- Silver HM, Seebeck M, Carlson R. Comparison of total blood volume in normal, preeclamptic, and nonproteinuric gestational hypertensive pregnancy by simultaneous measurement of red blood cell and plasma volumes. *Am J Obstet Gynecol* 1998; 179(1):87-93.
- Spaanderman ME, Aardenburg R, Ekhart TH, van Eindhoven HW, van der Heijden OW, van Eyck J, et al. Non-pregnant circulatory volume status predicts subsequent pregnancy outcome in normotensive thrombophilic formerly preeclamptic women. *Eur J Obstet Gynecol Reprod Biol* 2001; 95(2):218-21.
- Aardenburg R, Spaanderman ME, Ekhart TH, van Eindhoven HW, van der Heijden OW, et al. Low plasma volume following pregnancy complicated by pre-eclampsia predisposes for hypertensive disease in a next pregnancy. *BJOG* 2003; 110(11):1001-6.
- Kristal-Boneh E, Fromm P, Harari G, Ribak J. Seasonal differences in blood cell parameters and the association with cigarette smoking. *Clin Lab Haematol* 1997; 19(3):177-81.
- Shapiro Y, Hubbard RW, Kimbrough CM, Pandolf KB. Physiological and hematologic responses to summer and winter dry-heat acclimation. *J Appl Physiol* 1981; 50(4):792-8.
- Morimoto T, Shiraki K, Asayama M. Seasonal difference in responses of body fluids to heat stress. *JPN J Physiol* 1974; 24(3):249-62.
- Subramaniam V. Seasonal variation in the incidence of preeclampsia and eclampsia in tropical climatic conditions. *BMC Women Health* 2007;7:18.

26. Levine RJ, Hauth JC, Curet LB. Trial of calcium to prevent preeclampsia. *N Engl J Med* 1997; 337:69-76.
27. Taufield PA, Ales KL, Resnick LM, Druzin ML, Gertner JM, Laragh JH. Hypocalciuria in preeclampsia. *N Engl J Med*, 1987; 316(12):715-8.
28. Zemel MB, Zemel PC, Berry S, Norman G, Kowalczyk C, Sokol RJ, et al.. Altered platelet calcium metabolism as an early predictor of increased peripheral vascular resistance and preeclampsia in urban black women. *N Engl J Med* 1990; 323(7):434-8.
29. Salvig JD, Oslen SF, Secher NJ. Effects of fish oil supplementation in late pregnancy on blood pressure: a randomized controlled trial of fish oil in high risk pregnancy. *Br J Obstet Gynaecol* 1996; 103:529-533.
30. Chappell LC, Seed PT, Briley AL. Effect of antioxidants on the occurrence of pre-eclampsia in women at increased risk: a randomized trial. *Lancet* 1999; 354:810-16.
31. Rajkovic A, Catalano PM, Malinow MR. Elevated homocysteine levels with preeclampsia. *Obstet Gynecol* 1997;90:168-71.
32. Aali BS, Janghorbani M. Epidemiology of Preeclampsia in Pregnant Women Referred to Shahid Bahonar Hospital of Kerman in 1994. *Kerman Med J* 1996; 4(1): 20-25. (Persian)

9/29/2012

Comparison of *Helicobacter pylori* infection between pregnant women with hyperemesis gravidarum and controls

Fariba Nanbakhsh¹, Hamideh Mohaddesi^{*},² Fatemeh Bahadory¹, Javad Amirfakhrian³, Pouya Mazloomi³

1. Department of Obstetrics and Gynecology, Urmia University of Medical Sciences, Urmia, Iran
2. School of Nursing and Midwifery, Urmia University of Medical Sciences, Urmia, Iran
3. General Practitioner, Urmia University of Medical Sciences, Urmia, Iran
hmohaddesi.han@gmail.com

Abstract: A small percentage of pregnant women experience a severe form of nausea and vomiting called Hyperemesis gravidarum. To compare the rate of *H. pylori* infection between an Iranian samples of pregnant women who were suffering from hyperemesis gravidarum (HG) in their first trimester and control pregnant women without HG. In this cross-sectional study 30 pregnant women who suffered from HG and 30 controls were enrolled. *H. pylori* specific serum IgG was measured using ELISA method. IgG titers of more than 10, less than 10, and between 5 and 10 U/mL were considered as seropositive, seronegative, and suspicious for *H. pylori* infection, respectively. No significant difference was seen between the two groups regarding age, gestational age, and gravidity. Twenty-four patients (92.3%) in HG group had *H. pylori* infection, while this rate was only 7.7% (two patients) in control group ($P < 0.001$). No correlation was detected between IgG titers and either maternal age ($t=2.4$, $P = 0.12$) or parity ($\chi^2=0.2$, $P = 0.6$). There was significantly higher rate of *H. pylori* infection in HG pregnant women in their first trimester in comparison to controls..

[Fariba Nanbakhsh, Hamideh Mohaddesi, Fatemeh Bahadory, Javad Amirfakhrian, Pouya Mazloomi. **Comparison of *Helicobacter pylori* infection between pregnant women with hyperemesis gravidarum and controls.** *Life Sci J* 2012;9(4):1315-1318] (ISSN:1097-8135). <http://www.lifesciencesite.com>. 199

Keywords: Hyperemesis gravidarum; *helicobacter pylori*; pregnant women

1. Introduction

Nausea and vomiting is a major complaint in 70-80% of pregnancies. The typical onset is between 4 and 8 weeks and continues until 14-16 week of pregnancy (Cunnigham et al, 2010). The condition is usually self limiting and peaks at around 9th gestational week. However, in up to 20% of cases, nausea and vomiting may continue until delivery. Nausea and vomiting occurs significantly more often in primigravidas and in women who were less educated, younger, non-smokers, obese, or those with a history of nausea and vomiting in a previous pregnancy (Jueckstock et al,2010).

A small percentage of pregnant women experience a severe form of nausea and vomiting called Hyperemesis gravidarum (HG). More than 59,000 pregnant women with HG are hospitalized in the US annually.

Asian populations tend to have higher incidence rates. For example, a Malaysian study identified 192 recorded cases (3.9%) out of 4,937 maternities (Fejzo et al, 2008)

HG is often associated with weight loss, ketonemia, ketonuria, dehydration, and acidosis from starvation, alkalosis from loss of hydrochloric acid, electrolyte disturbances and even hepatic and renal damage (Eliakim et al, 2000).

Estimate of incidence of HG varies widely depending on diagnostic criteria sand different study

populations. Some sources state a proportion of 0.5-2% of all pregnancies, whereas others provide an incidence of 0.3-1.5% of all live births (Aytac et al,2007.ACOG 2004).

HG can be associated with serious maternal and fetal morbidity such as Wernicke's encephalopathy, fetal growth restriction, and even maternal and fetal death (Bailit, 2005).

Although the pathophysiology for HG is not clear, many hypotheses have been proposed to explain the etiology and pathophysiology of HG including psychological factors, gastrointestinal tract dysfunction, endocrinologic changes, infections, immunological and metabolic causes, and anatomical factors. However, there is no single theory to provide an adequate explanation for all the manifestations of HG (Aytac et al, 2007. Karaca et al, 2004. Verberg, 2005. Niebyl, 2010).

A number of risk factors associated with HG have been reported including nulliparity, (Atanackovic, 2001) low maternal age(Eliakim et al, 2000. Kallen, 2003), multiple gestation (Eliakim et al, 2000. Basso and Olsen, 2001. Schiff et al, 2004), metabolic disturbances, trophoblastic disorders, fetal anomalies (Eliakim et al, 2000. Schiff et al, 2004), previous pregnancy complicated by HG,(Eliakim et al, 2000) female sex of the fetus (Basso and Olsen, 2001. Schiff et al, 2004), psychiatric conditions(Atanackovic, 2001., Swallow et al, 2004),

both high and low maternal pregnancy weight and lower socio-economic status (Eliakim et al, 2000. Schiff et al, 2004.. Rochelson et al, 2003). Smoking, on the other hand, has been associated with a reduced risk of HG (Kallen et al 2003. Schiff et al,2004).

Chronic infection with *Helicobacter pylori* (*H. pylori*) may also cause HG. *H. pylori* are a gram negative, spiral shaped, microaerophilic bacterium that colonizes the gastric mucosa of the human being and is associated with type B gastritis, peptic ulcer and cancers (Graham 2000). The prevalence rate is higher in developing countries especially among those with low socioeconomic status (Soll 1996). It is estimated that 50-65% of the world population is colonized with this bacterium (Jaakkimainen et al, 1999), but despite this high prevalence, only a proportion of these people are clinically manifested, the reason may be related to host defense factors(Mobley 1997).

Recently several studies have implicated *H. pylori* infection as a possible cause for HG. However, there are also reports that did not show any relationship between *H. pylori* infection and occurrence of HG. Nevertheless, no conclusive evidence has been adduced to suggest a direct causal relationship between *H. pylori* infection and HG. So, the role of *H. pylori* infection in HG is controversial (Karaca et al, 2004, Karadeniz et al 2006. Salimi-Khayati et al 2003. Erdem_ et al 2002. Wu et al 2000).

The purpose of the present study was to investigate any possible association between infection with *H. pylori* and HG. In the case of this association, eradication of *H. pylori* may help to treat HG in a group of Iranian pregnant women which is a problem in the first trimester of pregnancy.

2. Material and Methods

Sixty consecutive pregnant women in the first trimester of their pregnancy were entered into this cross-sectional study. Thirty women had HG (HG group) and 30 did not have HG (control group). The criteria for the presence of HG were pernicious vomiting (more than 3 times per day) without any obvious cause except of pregnancy, weight loss of more than 3 kg or 5% of body weight, and the presence of at least +1 ketonuria. Inclusion criteria for experimental group included having HG, age of 15-45 years, gestational age < 20 weeks and exclusion of other causes of vomiting such as hyperthyroidism, molar pregnancy, infectious diseases, psychological disorders, multiple pregnancies and gastrointestinal disorders. Thirty pregnant women in their first trimester were entered as control group. Inclusion criteria for control group were the same as for HG group except for symptoms of HG. The control group was selected among

asymptomatic pregnant women that were visited at the antenatal clinic of our hospital.

Venous blood was obtained at the first visit. *H. pylori* specific IgG antibody titer was measured using by enzyme-linked immune sorbent assay (ELISA) method. IgG titer less than 10 U/mL was considered negative and a titer more than 10 U/mL was interpreted as positive. IgG titer between 5 and 10 U/mL was considered as suspicious. Gestational age was determined using the date of the last menstrual period and was confirmed by ultrasonography. IgG measurement was done two times for all sera.

Statistical analysis was performed using SPSS software for Windows (ver. 10.0). Descriptive indices including mean, standard deviation (SD), frequency, and percentage were used to express data. For comparison of categorical variables, the chi-squared test and for continuous variables, the student t test was applied. Significance level was set at $P < 0.05$.

Informed consent was obtained from all participants. The study protocol was in accordance with the Helsinki Declaration and approved in ethics committee of Urmia University of Medical Sciences.

3. Results

Table 1 presents demographic characteristics of both groups. The age of the women in both groups ranged was 15-45 years. Mean (SD) age of HG group was 26.1 (± 2.5) years and in control group was 25.03 (± 2.8) years ($P = 0.4$). There was no significant statistical difference between the two groups regarding demographic variables.

Table 1. Demographic characteristics of patients and controls

Parameters	HG group	Controls	P value
Age, year	26.1 (± 2.5)	25.03 (± 2.8)	0.478
Gravidity	1.73	1.6	0.6
Parity	0.7	0.6	0.44
Gestational week	9.9	9.6	0.55
<i>H. Pylori</i> seropositivity	24 (92.3%)	2 (7.7%)	0.001

Table 2 presents *h. pylori* seropositivity in the studied groups. Twenty-four patients (92.3%) in HG group had *H. pylori* infection, while this rate was only 7.7% (two patients) in control group ($P < 0.001$; $\chi^2 = 32.8$).

Table 2. *H. pylori* seropositivity in HG and control groups

<i>H. pylori</i> serostatus	HG group	Controls	Total	P value
Positive	24 (92.3%)	2 (7.7%)	26	<
Negative	1 (5.9%)	16 (94.1%)	17	0.001
Suspicious	5 (29.4%)	12 (70.6%)	17	

In Table 3, mean (SD) values of H. pylori specific IgG antibody titer has been depicted. Mean (SD) IgG titer was 23.34 (\pm 13.9) U/mL (range, 4.7-62.6) in HG groups and was 6.09 (\pm 4.5) U/mL in control groups (range, 1.4-21.7).

One patient in HG group and 16 patients in control group had IgG titers of less than 5 U/mL. Borderline IgG titer (5-10 U/mL) was observed in 17 cases (5 patients (29.4%) in HG group vs. 12 cases (70.6%) in control group; $P < 0.001$).

We did not find any correlation between IgG titers and either maternal age ($t=2.4$, $P = 0.12$) or parity ($\chi^2=0.2$, $P = 0.6$).

There was no statistically significant difference in gestational age and gravidity between patients and controls ($\chi^2=0.44$, $p=0.55$).

Table 3. Comparison of mean (standard deviation) H. pylori specific IgG titer between HG patients and controls.

H. pylori specific IgG titer	Max.	Min.	Mean (\pm SD)	P value
HG group	62.6	4.7	23.4 (\pm 13.9)	< 0.001
Controls	21.7	1.4	6.09 (\pm 4.5)	
Total	62.60	1.4	14.71	

4. Discussions

It is estimated that H. pylori infection might be present in two-thirds of the world population. However, the pathogenic relationship between HG and H. pylori is not self evident because most of those infected with H. pylori do not complain of symptoms. In other words, the presence of H. pylori can be asymptomatic. Furthermore, the problems in diagnosis of H. pylori infection are more complicated during pregnancy since HG can mask an active H. pylori infection or HG may be worsened by superimposed H. pylori infection (Karadeniz et al 2006).

A possible explanation for an association between H. pylori infection and HG could be an increased accumulation of fluid and a displacement of intracellular and extracellular volumes which occur in the early phase of pregnancy as a result of increase in steroid hormones. These physiologic changes results in a change of gastric pH levels which could lead to the manifestation of a latent H. pylori infection in the gastrointestinal tract (Frigo et al 1998, Kocak et al 1999). The results of this study show that the seropositivity of H. pylori in the HG group was significantly higher than in control group. Recently, it was shown that H. pylori seropositivity was significantly high in pregnant women who suffer from HG. Our findings are in accordance with the previous studies (Karaca et al 2004, Frigo et al 1998,

Kocak et al 1999). However, some recent studies could not find such association. Thus this is one of the controversial issues in obstetric care (Jacobson et al 2003, Berker et al 2003). For example, Berker et al. reported insignificant difference between HG patients (70%) and controls (61.3%) regarding the presence of H. pylori infection using H. pylori specific IgG. Similar results were noted by Lee et al. (Mobley 1997) who demonstrated the prevalence of H. pylori infection in HG patients to be 65%, while this figure was 66.7% in controls.

Frigo et al. reported statistically significant differences between HG patients and asymptomatic ones regarding H. pylori infection (90.5% vs. 46.5%) (Frigo et al 1998). Kocak et al also found similar results (92% in HG patients vs. 45% in controls) (Kocak et al 1999). Salimi-Khayati et al. revealed significantly higher H.pylori seropositivity in HG patients (88.9%) than in control ones (40.7%) Salimi-Khayati et al 2003).

In a total of 12 studies reviewed regarding H. pylori infection in HG patients, 11 relied on the serologic assay of H. pylori infection, and the great majority of them showed significantly increased infection rate in HG patients. The authors of three studies were not able to demonstrate any meaningful difference in H. pylori infection rates between HG patients and controls (Jacobson et al 2003, Berker et al 2003).

Several results were not able to demonstrate any significant differences between HG patients and asymptomatic ones as regards H. pylori IgG antibody seropositivity (Jacobson et al 2003).

Aytac et al. did not find any significant difference between HG patients and control ones (41.1% vs. 40%) suggesting no causal relationship between H. pylori infection and HG (Aytac et al 2007). Karadeniz et al. reported the prevalence of H. pylori IgG antibody was 67.7% (21 of 31) in the patients with HG and 79.3% (23 of 29) in controls ($P = 0.31$). There was no statistically significant difference in study and control groups for H. pylori IgG Ab and H. pylori SA in that study. (Karadeniz et al 2006).

Two recent studies found no association between HG and Hp seropositivity, one conducted in two US populations with disparate Hp seropositivity and the other by Berker et al from Turkey (Jacobson et al 2003, Berker et al 2003).

5. Conclusion:

This study suggests an association between H. pylori infection and hyperemesis gravidarum. Serologic test, moreover, being a non-invasive, cheap and easy to use, we recommend its routine use in patients with hyperemesis gravidarum as well as in

women who desire to become pregnant in the near future.

Acknowledgments:

The authors wish to thank the colleagues and patients that were kindly engaged and collaborated with us throughout this study.

Corresponding Author:

Dr. Hamide Mohaddesi
Department of Obstetrics and Gynecology, Urmia,
University of Medical Sciences, Urmia, Iran
E-mail: hmohaddesi.han@gmail.com

References

- Cunningham G, Gant NF, Kenneth JL. William's Obstetrics. 21st ed. McGraw-Hill Company, Philadelphia, 2001.
- Jueckstock JK, Kaestner R, Mylonas I. Managing hyperemesis gravidarum: a multimodal challenge. *BMC Med* 2010; 8: 46.
- Fejzo MS, Ingles SA, Wilson M. High prevalence of severe nausea and vomiting of pregnancy and hyperemesis gravidarum among relatives of affected individuals. *Eur J Obstet Gynecol Reprod Biol* 2008; 141: 13- 17.
- Eliakim R, Abulafia O, Sherer DM. Hyperemesis gravidarum: a current review. *Am J Prenatal* 2000;17: 207-18.
- Aytac S, Türkay C, Kanbay M. Helicobacter pylori stool antigen assay in hyperemesis gravidarum: a risk factor for hyperemesis gravidarum or not? *Dig Dis Sci* 2007; 52: 2840-83.
- ACOG (American College of Obstetrics and Gynecology): Practice bulletin: nausea and vomiting of pregnancy. *Obstet Gynecol* 2004; 103: 803-14.
- Bailit JL. Hyperemesis gravidarum: epidemiologic findings from a large cohort. *Am J Obstet Gynecol* 2005;193:811-14.
- Karaca C, Güler N, Yazar A. Is lower socio-economic status a risk factor for Helicobacter pylori infection in pregnant women with hyperemesis gravidarum? *Turk J Gastroenterol* 2004; 15: 86-9.
- Verberg MF, Gillott DJ, Al-Fardan N. Hyperemesis gravidarum, a literature review. *Hum Reprod Update*. 2005; 11: 527-39.
- Niebyl MD. Clinical practice. Nausea and vomiting in Pregnancy. *N Engl J Med* 2010;363: 1544-550
- Atanackovic G, Wolpin J, Koren G. Determinants of the need for hospital care among women with nausea and vomiting of pregnancy. *Clin Invest Med* 2001; 24:90- 93.
- Kallen B, Lundberg G, Aberg A. Relationship between vitamin use, smoking, and nausea and vomiting of pregnancy. *Acta Obstet Gynecol Scand* 2003, 82,916-20.
- Basso O, Olsen J. Sex ratio and twinning in women with hyperemesis or pre-eclampsia. *Epidemiology* 2001;12: 747-9.
- Schiff MA, Reed SD, Daling JR. The sex ratio of pregnancies complicated by hospitalisation for hyperemesis gravidarum. *BJOG* 2004; 111: 27- 30.
- Swallow BL, Lindow SW, Masson EA. Psychological health in early pregnancy: relationship with nausea and vomiting. *J Obstet Gynaecol* 2004; 24: 28 -32.
- Rochelson B, Vohra N, Darvishzadeh J. Low prepregnancy ideal weight: height ratio in women with hyperemesis gravidarum. *J Reprod Med* 2003; 48: 422- 24.
- Graham DY. Helicobacter pylori infection is the primary cause of gastric cancer. *J Gastroenterol* 2000; 35: 90-97.
- Soll AH. Helicobacter pylori induced gastritis. In: Bennet JC, Plum F, eds. Cecil Textbook of Medicine, (20th edn). Philadelphia: WB Saunders; 1996.
- Jaakkimainen RL, Boyle E, Tudiver F. Is Helicobacter pylori associated with non-ulcer dyspepsia and will eradication improve symptoms? A Meta-analysis. *BMJ* 1999;319: 1040 -44.
- Mobley H. Helicobacter pylori factors associated with disease development. *Gastroenterology* 1997; 113: 521- 8.
- Karadeniz RS, Ozdegirmenci O, Altay MM. Helicobacter pylori seropositivity and stool antigen in patients with hyperemesis gravidarum. *Infect Dis Obstet Gynecol* 2006;2006:73073.
- Salimi-Khayati A, Sharami H, Mansour-Ghanaei F. Helicobacter pylori aeropositivity and the incidence of hyperemesis gravidarum. *Med Sci Monit*. 2003;9: CR12-5.
- Erdem A, Arslan M, Erdem M. Detection of Helicobacter pylori seropositivity in hyperemesis gravidarum and correlation with symptoms. *Am J Perinatol* 2002; 19: 87- 92.
- Wu CY, Tseng JJ, Chou MM. Correlation between Helicobacter pylori infection and gastrointestinal symptoms in pregnancy. *Adv Therapy* 2000; 17: 152- 8.
- Frigo P, Lang C, Reisenberger K. Hyperemesis gravidarum associated with Helicobacter pylori seropositivity. *Obstet Gynecol* 1998; 91: 615-17.
- Kocak I, Akcan Y, Ustun C. Helicobacter pylori seropositivity in patients with hyperemesis gravidarum. *Int J Gynecol Obstet* 1999; 66: 251-4.
- Jacobson GF, Autry AM, Somer-Shely TL. Helicobacter pylori seropositivity and hyperemesis gravidarum. *J Reprod Med* 2003; 48: 578 -82.
- Berker B, Soylemez F, Cengiz SD. Serologic assay of Helicobacter pylori infection. Is it useful in hyperemesis gravidarum? *J Reprod Med* 2003; 48: 80 -2.
- Lanciers S, Despinasse B, Mehta DI. Increased susceptibility to Helicobacter pylori infection in pregnancy. *Infect Dis Obstet Gynecol* 1999;7: 195-8.

9/29/2012

Studying the social and cultural factors related to Tabriz citizen's participation

Mahmoud Elmi

Department of social sciences. Tabriz Branch Islamic Azad University, TABRIZ IRAN.
drmahmoodelmi@gmail.com

Abstract: The aim of this paper is to study the social and cultural factors related to Tabriz citizen's participation. The method of study is survey and the measurement tool for collecting data was questionnaire. The statistical population of this study includes the 15- 45 residents (male and women) in Tabriz who were 820000 people from whom we choose 680 people as samples. We categorized them in three age groups: 15-25, 25-35, 35-45. In this paper, there was a significant correlation between independent variables (social conformity, social trust, satisfaction from government, modernization, availability to mass communication media, age, gender, rate of following the culture, economical- social statutes of citizens) and dependent (participation). There was also significant and inverse correlation between modernization and participation. According to low rate of citizen's participation, we can say that this situation is the result of structural limitations in cultural and political system in Iran. People's linkage with society and relationship with it or dissociation from society, are all related with social and cultural environment of society. What lead the actions are the behavioral patterns and habits which can be found in society and different institutions of society.

[Mahmoud Elmi. **Studying the social and cultural factors related to Tabriz citizen's participation.** *Life Sci J* 2012;9(4):1319-1323] (ISSN:1097-8135). <http://www.lifesciencesite.com>. 200

Keywords: participation, social conformity, social trust, modernization, following the culture, availability to media, satisfaction from government.

1. Introduction

Participation is a human right which leads to freedom, believe to people's ego, mobilization of human being in social processes. These days, the social scientists discuss some issues such as development, justice and mutual rights in which the most important criterion for division and categorizing them is "participation" (Roushan, 2007: 4).

According to the importance of citizen's participation in development process and being aware from this fact that participation is an interaction and forms the social life bases and the social life is based on citizen's participation in the way that human community can not be alive without citizen's participation, in this paper we try to find answer to this question that how is Tabriz citizen's participation? Which social and cultural factors are related to this fact? The aim of this study is to indentify the rate of citizen's participation in Tabriz and find the related factors with it in different social and cultural fields.

Ingelhart believes that high rate of participation in West refers to three factors: high level of education and political information, the altered dominant norms in women's participation and changes in value priorities. He also states that variables such as education, social- economical status, level of information and skill, communicational skills, work experience and organizational networks affect the rate of participation.

According to Oakley and Marsden, when participation equals informing people and making

important decisions in development, participation can not be independent from control and responsibility of government. Lerner considers as a modernization criterion in society. He also emphasizes on psychological and mental variables which help to get modernization. Huntington believes that development and participation needs the formation of personality and modern person. He says that traditional person focuses on being quiet and does not want any changes in nature and society, while a modern person faces with different attitudes and procedures. The modern person accepts any changes and alternations and tries to adopt himself with them (Huntington, 1991:54).

Almond and Powel stresses on the role of self reliance in modernization and citizen's participation. From their point of view, modern person is an informed citizen and participant who not only has self reliance in decision making and does every thing independently and also accepts ideas and new believes, the citizen's participation reflects their utilization from opportunities prepared by the institutions. Habermas calls it a public area in which the communicational action occurs.

Public area is a social area of human life in which they can shape believes in contact with public believes. Public area is one of the modern criterions of modern world that is bourgeois society. He states that public area is basically a network of communication that is used for creating a social place to exchange the concepts among people and groups. Unlike the other institutions which are dominated externally or involve the internal power relations, public area promises the

participation principles and democratic regulation (Houlab, 1999:26).

Based on exchange theory, people are exact creatures who consider their profits and costs in different material and non material forms. Then, they act. Although this theory is not limited to individual actions and moves towards the collective actions, therefore, it considers the collective action as the final product of all people's action. People argue the whole works based on profits and satisfaction and use it as a basis for participatory or non participatory action. People shows tendency towards participatory action when in a collective and participatory situations, it is possible to access the benefit rapidly and easily. Otherwise, they prefer to do act individually.

According to the results of Yazdan Panah study, there was low formal participation rate (voluntary one) in non government organizations among Tehran citizens. It shows that most of participations were informal and social one such as helping the poor and participation in mornings. This study also shows that the subjects have experienced many individual confusion and powerlessness and they also faced with different obstacles in social participation.

Based on these results, when there is high powerlessness and personal confusion, there will be low volunteer, conscious and purposeful participation in society. There are also family, economical, social obstacles which affected the rate of social participation (Yazdanpanah, 2007). The results of study among citizens of Tehran in zone 9 show that there is a relationship between powerlessness and citizen's participation, while there was not a significant relationship between people's tendency towards participation with municipality and getting benefit. The other results of this study show that there is a correlation between people's awareness from municipality activities and the citizen's participation. Between people's trust to municipality and participation with it was correlation, too. We can also find a correlation between education level, gender and people's tendency towards participation. The findings of study by Salahshour among some zones of Tehran reveal that the youth social participation was medium. The frequency of women participation was higher than men's participation but the intensity of women's participation was lower. Based on statistical analysis of this study we can see that there is a direct and significant correlation between sense of belongingness, social attachment, social satisfaction, using the mass media, social trust, age, social status and social participation. There as also adverse and significant correlation between confusion, alienation and social participation. There was a weak correlation between universalism, gender, rationality and social participation (Salahshour, 2006). Results of study by Alipour and his coworkers in some zones of Tehran

show that there is a significant correlation between social trust (in three forms: individual, generalized and institutional) and organized social participation, although the rate and orientation of this relationship in both cases are different from each other. Also, the regression coefficients of some variables show that among the studied variables, generalized trust and social- economical status are the best predictors of social participation (Alipour, Zahedi, Shyani, 2009).

In this research hypothesis as follow:

1. There is a relationship between social solidarity and rate of citizen's participation.
2. There is a relationship between satisfaction form government and rate of citizen's participation.
3. There is a relationship between social trust and rate of citizen's participation.
4. There is a relationship between social-economical status and rate of citizen's participation.
5. There is a relationship between group participation and rate of citizen's participation.
6. There is a relationship between social alienation and rate of citizen's participation.
7. There is a relationship between modernism and rate of citizen's participation.
8. There is a relationship between citizen's education level and rate of citizen's participation.
9. There is a relationship between following the social culture and rate of citizen's participation.
10. There is a relationship between the citizen's availability to communicational mass media and rate of citizen's participation.

Methodology

The method of this study is survey and the measurement tool is questionnaire. The statistical population of this study includes the whole 15-45 year old citizens in different parts of Tabriz who were 820000. The sample included 680 people which ere chosen through Cochran formula. We categorized them in three age groups: 15-25, 25-35, 35-45.

We used researcher- made questionnaire that included 54 questions about each of the different dimensions of participation.

We examined the content validity by using reviewer's evaluation of scale elements before data collection and Factor analysis for classifying participation scale elements in theoretical categories after data collection; so, we obtained the high validity of this study.

We obtain high reliability by using alpha Cronbach.

3. Results

From 680 samples of this study, there were 337 men, 343 women: 49.6% men and 50.4% women. In this study, we categorized the citizens to three age groups. In each group, 15-25, 26-35 and 36-45, we had 225 people which were about 33.1%. we also divided

the citizens to employed and unemployed groups: 375 (55%)0000 were employed and 306(45%) were unemployed, 14.7% workers, 12.1% technical job, 8.2% employee, 12.6% seller, 7.4% professional job. About the subjects' income we found out that 30% had low pay job about 3,000,000 Rial, 69% between 3,000,001-6,000,000 Rial, 87% between 6,000,001-9,000,000 Rial, 94.2% between 9,000,001-12,000,000 Rial in a month. About 51.1% of subjects had low social status, 35.9% medium social status, 13% high social- economical status. mean of citizen's participation, with 19.77 deviation standard, is 42.2 which is in low level: average social solidarity among these citizens, with 12.50 deviation standard, equals 52.63: average of modernization among these citizens are 65.62 and its deviation standard is 20.82: average of social alienation in these subjects is 19.57 and the rate following the culture is 77.92 whose deviation standard is about15.44: mean of satisfaction from government is about 61.62 with 19.13 deviation standard: the last one is trust among citizen's which is about 72.09 and 17.64 deviation standard. In this research, the independent variables were social solidarity, social trust, satisfaction from government, modernism, accessibility to communication mass media, age, gender, rate of following the culture, education level, income and economical-social status of citizens.

In order to test the relationship between social solidarity, social trust, using mass media, modernism, collective actions, social alienation, following the culture, satisfaction from government, social trust and citizen's participation we used R Pierson test. Results of these tests are shown in table1.

Table 1: Pierson coefficient correlation test

independent variables	Citizen's participation
Social solidarity	N=68 R=0/202 Sig =0.000
using mass media	N = 68 R=0/14 Sig=0.000
Modernism	N=68 R=0/216 Sig =0.000
Collective actions	N = 68 R=0/06 Sig=0.881
Social alienation	N = 68 R=0/26 Sig=0.507
Following the culture	N = 68 R=0/321 Sig=0.000
Satisfaction from government	N = 68 R=0/252 Sig=0.000
Social trust	N = 68 R=0/146 Sig=0.000

We used T- Test to find the difference between gender and citizen's participation. The result of study shows that there is a significant difference between men and women's participation mean. That is, the rate of women's participation is more than men's one.

Table 2: T-Test for comparing participation into gender groups

statistics / Gender	N	Mean	standard Deviation	t	sig
Men	337	38.49	18.68	4.92	0.000
women	343	45.84	20.15	4.92	0,000

In order to find the difference between job status and citizen's participation we also used T- test. The result of test shows that there was not significant difference between employed and unemployed citizen's participation mean.

Table 3: T-TEST for comparing participation into job status groups

Statistics	N	Mean	standard Deviation	t	Sig,
Employed	374	39.89	19.96	3.387	0.001
unemployed	306	45.01	19.17	3.4	0.001

We used analysis of variance test to measure the difference between education level and citizen's participation. The results of study show that there was not significant correlation between these two variables. In other words, education level does not have any affect on increasing or decreasing the participation rate.

Table4: descriptive statistics of citizen's education and participation level

Education level	N	Mean	Standard deviation	Min.	Max.
illiterate	62	41/13	15/90	12/50	
Reading and writing literacy	70	42/44	18/45	12/50	87/50
Elementary school	77	47/78	19/60	8/33	83/33
Secondary school	104	42/95	18/57	0	79/17
High school	79	43/41	20/70	0	87/50
Diploma	94	40/96	21/30	0	87/50
Higher education	177	40/11	20/98	4/17	95/83
Total	663	42/30	19/83	0	95/83

We also used analysis of variance test to find out the relationship between these two variables. The results show that there is a significant correlation between participation and age groups of citizens. In table 6, we have offered the results based on age groups (15-25), (26-35), (36-45).

Table 5: one way analysis of variance test of citizen's participation based on their age groups

Citizen's participation		Sum of squares	Df	Mean of squares	F	Sig.
	Between groups	7319/599	2	3659/799	9.657	0.000
	Among groups	244665/586	672	387/967		
	Total	26985/185	674			

According to significance of F- test, in order to follow up the significant differences in multi group analysis, we use LSD test. Result of this study show that the highest mean difference is observed in 15-25 age group because it has low mean in comparison with the other age groups.

Table 6: one way analysis of variance test of participation based on the citizen's social- economical status

citizen's participation		Sum of squares	df	Mean of squares	F	Sig.
	Between group	4375.611	2	2187.805	5.453	0.004
	Within group	251554.8	627	401.204		
	Total	255930.4	629			

According to significance of F- test, in order to follow up the significant differences in multi group analysis, we use LSD test. Result of this study show that the highest mean difference can be found in high and low social economical status.

Table 7: one way analysis of variance test of participation based on the citizen's income

Citizen's participation		Sum of squares	df	Mean of squares	F	Sig.
	Within group	5358.484	4	1339.613	3.384	0/009

According to significance of F- test, in order to follow up the significant differences in multi group analysis, we use LSD test. Results of this study show that the highest mean differences can be found among group with an income less than 3,000,000 Rial in a month.

Results of regression analysis on factors explaining the citizen's participation show that among the independent variables only 6 variables: following the culture, social solidarity, modernism, satisfaction from government, using media and social trust remained in the final model. These variables could explain 20% of variance changes in dependent variable. The final multi regression coefficient is 0.45 and its square is 0.20. Corrected R^2 is 0.198. The real and correct percent of changes of dependent variable made by independent variable is 20%. Results of multi regression analysis can be written in standard form as follows:

$$Y = \beta_1 * Z_{li} + \beta_2 * X_2 + \beta_p * X_{pi} + \xi_i$$

$$\beta(x'x^{-1})^{-1} x'Y$$

Citizen's participation = 0.239 (following culture) + 0.155 (social solidarity) + 0.155(modernism) + 0.122 (satisfaction from government) + 0.120 (using media) + 0.109 (social trust)

4. Discussion

Based on Parson's theory, when in different social situations, the individual's action are focused on the others, it leads to cooperation and solidarity with the others. There will be high solidarity when the individual's actions are ethical and collective one. In these actions, the responsibility, loyalty about the others, participation in society will be in high level.

The results of this study verify the theories and findings of the last studies. Findings of this study show that rate of participation is affected by education: it means that when the education level and social-economical status of people is high, there will be higher participation. This finding is inn harmony with theories of Lerner and Engelhard who believe that whenever the people's education level; is high, they will have higher tendency towards participation. Engelhard believes that the large group belongs to the youth and educated people. Lerner also believes that there is a relationship between education factor and social participation. Huntington and Nelson state that when people belong to high social- economical status and class, there will be high social participation. Among different variables, the education level has had the highest effect on social participation. Findings of this study show that there is a significant correlation between social status of people and their participation.

Theorists such as Engelhard and Putnam believe that trust encourages people to participation, collective and volunteer action. Findings of this study verify this theory. Data collected from the population of study also show that there is a significant correlation between social trust and participation($r=0.146$). That is, when people trust their relatives, rate of participation, collective action and cooperation will be high. Daniel Lerner considers participation as one of the main variables in development and modernism. He also believes that the development potential will be present in a society in which the communication instrument s and social participation facilities are available there. Lipsit focuses on the correlation between increasing the education level, mass media and emerging the democratic participation institutions. From Habermas' point of view, in a modern society, that is communication action in which the people are free from domination and can make their own world based on communicational- rational and democratic way. Communicational action is also formed in a public area. Public area, liberal dialogue and free from domination

are all necessities of participatory action. If person does not think that he/she is part of a society and feels that his/her action does not have any effect in society and also feels powerlessness in facing with problems and solving them, he/she will never participate in collective actions.

Recommendations

According to low level of citizen's participation in Tabriz (42%), we offer the following suggestions to increase the participation level:

1. Since that participation means commitment and accepting social and individual responsibility, there should be necessary situation for increasing the participation rate.
2. It seems that modern people do not have much tendency towards participation and the people's participation is mainly traditional one. Therefore, because of expanding the modern believes among the citizens, their participation has decreased. It is necessary that the civil and participatory institutions are formed in NGOs in the way that the citizens can voluntarily participate in these institutions.
3. Election right, liberty, rationality should be possible in society and people can participate in social affaires easily.
4. Private section should be separated from public area in the way that citizens can participate in the active way.

Acknowledgements:

The authors would like to thank Tabriz Branch, Islamic Azad University for the financial support of this research, which is based on a research project contract.

References

- 1- Roushan, S. (2007) sociological study of Tehran citizen's social participation in municipality affaires and its affect on the city management, Tehran: Islamic Azad University, Research and Science branch.
- 2- Salahshour, h. (2006) sociological study of the youth (18-39 years old) social participation in Tehran, M.A thesis, Tehran: Islamic Azad University, Research and Science branch.
- 3- Alipour, p. & Zahedi, m. & Shyani, M. (2009) trust and participation (studying the relationship between trust and social participation in Tehran), Iran Sociology Magazine, 10th edition, No: 2.
- 4- Gaffari, G. (2007) participation Sociology, Tehran: Nazdik press.
- 5- Huntington, S. (1991) political order in changing societies, translated by: Mohsen Solasi, Tehran: Elm press.
- 6- Houlab, R. (1999) criticism in public area, translated by: Hossin Boushrye, Tehran: Ney press.
- 7- Yazdanpanah, L. (2007) the social participation obstacles of Tehran citizens, Research and Science quarterly of social welfare, 7th year, No: 26.

9/6/2012

Bioremediation of Khormah Slaughter House Wastes by Production of Thermoalkalstable Lipase for Application in Leather Industries

Bayoumi,R.A.¹, Atta,H.M.¹and El-Sehrawy,M.H.²

¹Biotechnology Dept., Faculty of Science and Education, Taif Univ. (Khormah branch), KSA.

¹Botany and Microbiology Dept. Faculty of Science (Boys), Al-Azhar Univ.,Cairo,Egypt,P.N.:11884

²Biology Dept., Faculty of Science, Taif Univ., Taif, KSA

reda.elbayoumi@yahoo.com

Abstract: Thermoalkalstable lipases enzymes occupy a very important group used for bioremediation of environmental pollutants, act as biocatalysts and many other industrial application. One of the major industrial microorganism is the *Bacillus* sp. which are abundance in the desert localities. The aim of this research was to isolate, characterize of lipase producing bacteria from Khormah slaughter house wastes (SHW), Taif, Makkh, KSA, thermoalkalstable lipase production and its purification. SHW was found to be the most successful natural source for thermoalkalstable lipase production. Twenty eight lipase producing bacterial isolates were isolated. One strain was selected as a best thermoalkalstable lipase producer identified by morphological, physiological and biochemical characteristics as *Bacillus stearothermophilus* KGSHW-1. The identification was confirmed by molecular biology technique. Different factors such as temperature, pH, incubation period, nutritional requirements, substrate concentration, inoculum size, vitamin requirements, effect of metallic ions, effect of incubation condition and bottle capacity were studied for improving thermoalkalstable lipase production. An optimum conditions for production of thermoalkalstable lipase by *B. stearothermophilus* KGKSA-1 was achieved at 60°C, after 24 h. of fermentation at pH 10. Beef extract, vitamin B6 were the best carbon source and vitamin source, while potassium nitrate served as a source for nitrogen. Tryptophan was served as best amino acids, substrate concentration 75 (%w/v) inoculated by 1 ml (7×10^{10} CFU.ml⁻¹) under shaking conditions in 2.5% of 250 ml capacity. BaCl₂ was induced the enzyme production. This enzyme was purified using acetone concentration 60% precipitation and gel filtration column using Sephadex G200 and 100 respectively. The purification fold steps for precipitation by acetone, dialysis against sucrose, Sephadex G200 and Sephadex G100 were found 2.086, 1.43, 14.9 and 39.8 respectively. Sodium dodecyl sulphate revealed that the monomeric lipase has 60 kDa of its monomeric lipase. These results show a great potential for the use of this produced enzyme in industry and other future studies.

[Bayoumi,R.A., Atta,H.M. and El-Sehrawy,M.H. **Bioremediation of Khormah Slaughter House Wastes by Production of Thermoalkalstable Lipase for Application in Leather Industries.** *Life Sci J* 2012;9(4):1324-1335] (ISSN:1097-8135). <http://www.lifesciencesite.com>. 201

Key words: Thermostable lipase, Alkalistable lipase, Nutritional requirements, Thermophilic bacteria, Slaughter house wastes.

1. Introduction

Lipases (Triacylglycerol hydrolases EC3. 1. 1.3) are diverse group of enzymes that catalyze the hydrolysis of ester bonds in triacylglycerides to liberate fatty acids and glycerol, showing activity on a great variety of substrates (Jaeger *et al.*,1999). Due to the fact that extracellular thermoalkalstable lipases are quite stable under extreme environments (pH, temperature...etc), substrate specificity and active in organic solvent, these enzymes occupy a very important place in the bioremediation of food wastes and generally considered as most important group of biocatalyst for biotechnological applications. Other applications include the pharmaceutical (resolution of racemic mixtures), dairy (hydrolysis of milk, fat), detergent (removal of oil/fat stains), cosmetic, oleochemical, fat processing, food flavoring, leather processing (removal of lipids from hides and skin), textile, paper industries, medical (diagnostic tool in

blood triglyceride assay) industries and waste water treatment (degreasing of lipid clogged drains) (Posorsk,1984; Macrae and Hammond,1985; Sharma *et al.*, 2001;Snellman and Colwell, 2004). Lipases can be naturally and readily found in the earth's flora and fauna. However, most commercial lipases are produced from microbes. Alkaliphilic microorganisms are widely distributed in nature and alkaliphilic *Bacillus* strains are often good source of alkaline extracellular enzymes (Abdul-Hamid *et al.*,2003; Littechild *et al.*, 2007;Ghori *et al.*, 2011).

Microbial lipases are usually extracellular enzymes, which are produced by bacteria, fungi and actinomycetes. Bacterial strains are generally more used as sources of lipases because they offer higher activities compared to other microorganisms. Bacterial enzymes are often more useful than enzymes derived from plants and animals because of the great variety of catalytic activities available, the

high possible yields, ease of genetic manipulation, regular supply due to absence of seasonal fluctuations and rapid growth of microorganisms on inexpensive media. They are also more stable and safer than their production is more convenient. Microbial lipases have already established their vast potential regarding usage in numerous applications. Many microorganisms are capable of producing lipase and *Bacillus* sp. is the most widely studied group. *Bacillus* species lipases have been purified and biochemically characterized from many *Bacillus* species such as *Bacillus subtilis*, *Bacillus pumilus*, *Bacillus stearothermoleovorans* and their genes have been cloned and sequenced (Kim *et al.*, 2002).

Bacillus lipases attract attention because they have unique protein sequences and many uncommon biochemical properties (Kim *et al.*, 2002). In contrast many bacteria other than *Bacillus* sp. have been studied for their lipase production ability (Gupta *et al.*, 2004), among them are *Arthrobacter* sp. (Sharma *et al.*, 2009), *Pseudomonas* sp. (Meghwanshi *et al.*, 2006) and *Staphylococcus* sp. (Horchani *et al.*, 2009). One of the major industrial microorganism is the *Bacillus* species which are in abundance in the desert regions. Thermophilic bacteria is an important source of thermostable enzymes (Rahman *et al.*, 2007; Zuridah *et al.*, 2011; Patil *et al.*, 2011) and desert environments are usually their favorable habitats. In Kingdom of Saudi Arabia (KSA), Makkah region Khormah governorate slaughter house throw huge amount of wastes. These wastes have been explored their potential as a source of thermophilic bacteria. Thermophilic organisms are defined as those that have their optimal growth temperature between 50 and 80°C (Brown, 2005). Potential enzymes such as amylase, protease, xylanase and chitinase have been identified in thermophilic microorganisms including the lipase enzyme (Dominguez *et al.*, 2005).

In order to be used in industry, lipases need to be thermostable and maintain their activity in organic solvents (Nawani and Kaur, 2001, 2007). Thermostability is required since many processes use temperatures around 50 °C due to the high melting points of the lipids that are used as substrates (Lima *et al.*, 2003, 2004; Hasan *et al.*, 2006, 2007). Lipases are of significant important in leather industry. Degreasing of leather during its processing in an important use of lipases in tanning industry in the process of bating, removal of fat and protein debris by chemical processes in both polluting and laborious. Lipase can play distinct role in resolving such problems of leather industry and tanneries. Therefore, researchers in search of novel lipases with high catalytic rates from microbial sources (Ghori *et al.*, 2011).

Because of the numerous potential uses of lipase enzyme, this study present a preliminary investigation on lipase produced from *B. stearothermophilus* isolated from Khormah governorate slaughter house wastes (KGSHW) as a local environment. The most potent resultant culture was investigated to determine optimal bacteria lipase production which include temperature, pH, incubation period, nutritional requirements, substrate concentration, inoculum size, vitamin requirements, effect of metallic ions, effect of incubation condition and bottle capacity were studied for improving lipase production. Purification of the produced thermoalkalizable lipase under all optimal conditions.

2. Materials & Methods

Sample collection, sampling sites and bacterial isolation:

Samples of fat, meat, water and polluted soil were collected from various locations at Khormah governorate slaughter house, Makkah, KSA. Samples were taken and transported in sterile plastic bags to laboratory and stored at 4°C when not used immediately. The slaughter house wastes mainly included fatty and meat pieces were found to be attached to general viscera of slaughtered animal. They were dried at a temperature of 70°C for 8 hours and kept in plastic bags at a refrigerator.

One ml or one gram (from each site or samples) were suspended in 10 ml of sterile double saline solution. After shaking, 5 ml of each suspension was transferred into a 250 ml Erlenmeyer flask containing 100 ml of an enrichment medium with the following composition: (g/L; w/v): Yeast extract, 5; olive oil, 10 ml. The mineral salt solution contained (g/L): KNO₃, 2.0; KH₂PO₄, 1.0; MgSO₄·7H₂O, 0.5; ZnSO₄·7H₂O, 0.44; FeSO₄·7H₂O, 1.1 and MnSO₄·7H₂O, 0.2. The pH of the medium was adjusted raised to 10 using 1 N NaOH. Plates were incubated at 60°C and growth checked every day for growth. Developed bacterial colonies were purified and transferred to the nutrient agar medium slants for storage. In addition, bacterial colonies were sub-cultured on nutrient agar medium plates for identification and lipase production. Nutrient agar medium containing (g/L): tryptone, 10.0, yeast extract, 5.0; NaCl, 5.0; Agar-agar, 20.0 (Buchanan, 1974).

Construction of standard curve of lipase enzyme

A stock solution of (200,000 µg/ml) of lipase (Sigma) was prepared in glycine NaOH buffer at pH 10. Descending dilutions were prepared. Lipolytic activity determination was performed by colorimetric assay according to (Castro-Ochoa *et al.*, 2005) with slight modifications.

Solution A: Stock solutions of *para*-Nitrophenyl laurate were freshly prepared in isopropanol at a concentration of 0.3% (w/v). This solution was emulsified by 3 min. sonication pulses of 0.3 s at 50 watts using a Lab sonic 1510 sonicator (B. Braun).

Solution B: This solution is 0.1% (w/v) Arabic gum, 0.4 % triton-X-100 (v/v) emulsified in 1 M phosphate buffer at 8 pH value. Then, 450 μ l of a 1:10 dilution of solution (A) in solution (B) were pre-incubated for 5 min. at the assay temperature before adding 50 μ l of lipase concentration previously prepared. This mixture was incubated at 30°C for 30 min., and the reaction was terminated by addition of 50 μ l of 0.1 M Na₂CO₃ and 450 μ l of distilled water. Released *p*-nitro phenol was immediately determined by measuring the absorbance at $\lambda = 410$ nm. Proper blanks were used to subtract the absorbance corresponding to the reaction mixture other than that produced by the specific hydrolysis of *p*-NP-derivatives. One unit of lipase activity was defined as the amount of enzyme that caused the release of 1 mol of *p*-nitrophenol (molar absorption coefficient 4.6mM⁻¹ cm⁻¹) from *p*NP-laurate in 30 min under test conditions.

Protein determination

Total protein content for all enzymatic preparations was determined by the method of **Lowry et al., (1951)** using Bovine Serum Albumin as standard.

Production medium:

Czapek- Dox's (**Dox,1910**) mineral salt medium was found to be the most convenient medium for production of lipase enzyme. It was altered to contain (g/l); yeast extract,20 ; NaNO₃,2 ;KH₂PO₄,1 ;MgSO₄.7H₂O,0.5 ;KCl,0.5 and CaCl₂,1 and supplemented with 1% of fatty wastes. The pH values of all above media were raised to 10 by 6N NaOH before sterilization.

Screening and identification of thermoalkaliphilic bacteria

Thermoalkaliphilic bacterial isolates, the subject of the present investigation were isolated from several localities around Khormah slaughtered house such as slaughter house wastes desert soil, polluted water. Lipolytic activity was detected on Czapek-Dox's mineral salt medium supplemented with 2% fatty wastes. Clear zones around the isolated colonies were detected which demonstrated lipase production (**Akatsuka et al.,2003**). Colonies with highest clear zone of hydrolyzing lipase on the plate were selected as potential lipase producing strain .Based on the lipase secretion on the Czapek- Dox's mineral salt medium supplemented with 2% fatty wastes agar plates , the best enzyme secreting organism was selected for lipase production. Identification of the thermoalkaliphilic bacterial isolate was carried out by

morphological, biochemical and physiological characteristics. Identification was confirmed by 16s ribosomal DNA gene sequencing technique according to **Woo et al., (2000)**.

Cell growth determination

Biomass concentration was measured via turbidity at 600 nm and obtained values were converted to concentration by using a previously determined calibration curve.

Fermentation technique

Ten gram of substrate was moistened with 10 ml of diluents in 250 ml of conical flask. The flasks were autoclaved at 15 lb/inch² pressure for 15 min. The flasks were cooled at room temperature. One ml of bacterial inoculum was aseptically transferred to each flask. The flasks were then placed in an incubator at 60°C for 48 hrs. The flasks were run parallel in triplicate. After 48 hrs. , 100 ml of buffer (pH 10)was added to each flask. The flasks were placed on rotary incubator shaker at 200 rpm for one hour. After one hour the ingredients of the flasks were filtered and centrifuged. The supernatant was used for estimation of lipase production.

Parameters controlling the optimum production of thermoalkaliphilic lipase(s) enzyme

Effect of incubation temperature on lipase production:

The most potent thermoalkaliphilic bacterial isolate was grown on Czapek-Dox's mineral salts medium supplemented with 2% slaughter house wastes at temperatures; 40, 50, 60, 65,70,75,80 and 85°C for 48 hrs. The crude enzyme preparation was obtained by centrifugation at 1000 rpm, at 4 °C for 15 min. The crude enzyme was assayed by colorimetric technique. All the experiments were conducted in triplicate and the average values were reported.

Effect of different pH values and buffers on lipase production

Production medium was prepared and pHs were designed at the following values: 7, 8, 9,10,11,12 by using 6N NaOH and 6N H₂SO₄.For determination of the best buffer that promotes the highest yield of thermoalkaliphilic lipase(s). Production medium was prepared by using each of Glycine-NaOH buffer (0.2 M) (at pH values; 8.6, 9, 9.2, 9.4, 9.6, 10, 10.4, 10.6), Carbonate-bicarbonate buffer (0.2 M) (at pH values; 9.2, 9.5, 9.8, 10.0, 10.2, 10.3, 10.6, 10.7) and Boric acid-Borax buffer (0.2 M) (at pH values; 9.3, 9.5, 9.7, 9.9, 10.1). Selection of these buffers was dependent mainly on their ability to provide the proper alkaline pH range.

Effect of fermentation period on lipase production

One ml of an 18 h. culture of *Bacillus* sp. was inoculated into sterilized 250 ml Erlenmeyer flask containing the lipase production medium. It was incubated for 6, 18, 24, 42, 48, 66, 72 hours.

Effect of nutritional factors of lipase production

To evaluate the effect of carbon sources on the lipase production, the following were added to lipase production medium at (1% w/v) glucose, galactose, xylose, ribose, rhamnose, melezitose, sorbitol, mannitol, inuline, sucrose, lactose, maltose, cellobiose, dextrine, starch, pectin, molasse and beef extract. All the carbon sources were sterilized separately through a 0.22 μm membrane filter and then added to the mixture.

Nitrogen sources were added to the production with an equimolecular amount. Different nitrogen sources were used to determine the favorable nitrogen source that fulfills the highest yield of thermoalkaliphilic lipases. The control was devoid from any nitrogen source. These nitrogen sources including ammonium chloride, ammonium sulphate, ammonium nitrate, ammonium molybdate, ammonium phosphate, sodium nitrate, sodium nitrite, urea, calcium nitrate, potassium nitrate and peptone.

Amino acids were supplemented to the production medium with equimolecular amounts to determine the optimum one(s) that fulfill the highest yield of thermoalkaliphilic lipases. These amino acids included lysine, ornithine, arginine, valine, phenylalanine, histidine, aspartic acid, tryptophan, glycine, threonine, alanine, serine, glutamic acid, cysteine, proline, citruline, methionine, cystine, asparagine and glutamine. The control was devoid from any nitrogen sources.

The lipase production medium was supplemented with different vitamins individually to determine the best vitamin that can improve the production. The control was devoid from any vitamin supplement and the separately vitamins added were; Ascorbic acid, Nicotinic acid, Riboflavin, Myristic acid, and Vitamin B6, each vitamin was applied in concentrations of 25, 50, 100, 250, 500 ppm.

Effect of substrate concentration

The effect of different substrate concentrations on the productivity of thermoalkaliphilic lipases was observed. The production medium was supplemented with different concentrations of slaughter house wastes including: 0.125, 0.250, 0.5, 1, 2, 5, 10, 20, 50 and 75 % (w/v).

Effect of different metallic ions

Different metallic ions were applied for studying their effects on the production of thermoalkaliphilic lipases by the two isolates to be either activators or inhibitors. Metal ions were supplemented separately in the form of EDTA, MgSO_4 , CuSO_4 , BeSO_4 , NiSO_4 , CaSO_4 , FeSO_4 , MnSO_4 , ZnSO_4 , $\text{Na}_2\text{MoO}_4 \cdot 2\text{H}_2\text{O}$, MnCl_2 , CaCl_2 , BaCl_2 , ZnCl_2 , CoCl_2 , MgCl_2 , CuCl_2 , FeCl_3 , and $\text{Na}_2\text{S}_2\text{O}_3$ at concentration of 500ppm. The control was

devoid of any metal ions and all previously mentioned optimum parameters were applied.

Purification of thermoalkaliphilic lipases

The crude enzyme preparation (1000ml) was fractionated with acetone organic solvent (20,40,60 and 80 %) (Deutcher, 1993). The protein precipitate was re-dissolved in a minimal volume of double – distilled water and the resulting enzyme was dialyzed overnight against the buffer (phosphate buffer pH8 1.0M) at 6 °C. The dialyzed sample was subjected to Sephadex G200. Fifty fractions were collected (each of 5 ml). Both enzyme activity and protein content were determined for each separate fraction (Soliman, 2003). Fractions of the sharp peak obtained after applying sephadex G 200 column were collected and tested for their activity and protein content. The peaks exhibiting lipase activity were pooled together and used as a purified enzyme and applied on Sephadex G100 by similar technique. Crude of thermoalkaliphilic and this partially purified enzyme solution was used for investigating the effects of temperature, pH, various metal ions on enzyme activity and its application in leather industries well published in other paper.

Sodium dodecyl sulfate polyacrylamid gel electrophoresis (SDS-PAGE)

For the characterization of proteins and evaluation of the protein enrichment process SDS-PAGE was performed in a discontinuous SDS-PAGE vertical slab gel electrophoresis apparatus as described by Laemmli *et al.*, (1970) and Sambrook *et al.*, (1989).

3. Results and Discussion**Standard curves and isolation of microorganisms**

Lipases are the special kind of esterases belong to subclass 1 of hydrolytic enzyme class 3 and have been assigned sub-sub class 3.1.1 due to their specificity for carboxylic acid ester bonds. The biological function of lipase is to catalyze the hydrolysis of triglycerols to give free fatty acids, diglycerols, mono-acylglycerols and glycerol. Most commercial lipases are produced from microbes (Jaeger *et al.*, 1999). Lipase occurs widely in nature : however microbial lipases are commercially significant because of low production cost, greater stability and wider availability than other sources. Few review articles were published (Pahoja and Sethar, 2002; Gupta *et al.*, 2004; Aravindan *et al.*, 2007; Patil *et al.*, 2011) on lipase sources along with its industrial applications. Lipases producing bacteria have been found in diverse habitats such as soil contaminated with oil, dairies, industrial wastes, oilseeds and decaying food, compost heaps, coal tips and hot springs. Vijayaraghavan *et al.*, (2011) mentioned that, several lipases from

B.thermocatenulatus (Schmidt-Dannert *et al.*,1996), *B. thermooleovorans* (Lee *et al.*,1999), *B.stearothermophilus* (Kim *et al.*,1998), *B. subtilis* (Eggert *et al.*,2000), *B.megaterium* (Jaeger *et al.*,1999;Ruiz *et al.*,2001, 2002;Jaeger and Eggert, 2001,2002) have been well described.

3.1. Construction of Standard curve of lipase enzyme

The productivity of lipase enzyme was estimated by colorimetric assay method depending on the esterification effect of lipase enzyme on *p*-nitrophenyle laurate and liberation of colored *p*-nitrophenol which is directly proportional with the density of lipase enzyme. The assay was achieved on spectrophotometer with absorbance at 410 nm. Descending dilutions of lipase enzyme (SIGMA) were prepared covering the range of (3125 – 800 000 µg protein / ml). The protein content was determined using the method of Lowry *et al.*, (1951) where the samples were read at 750nm calorimetrically. However, data of this method covered the range of (0.1 - 1 mg/ml) using the protein of egg albumin.

3.2. Localities of thermoalkaliphilic microbial isolates

In view of the variety of applications, there has been a renewed interest in the development of source of lipases. Bacteria, yeast and moulds can produce lipase but the availability of lipase with specific characteristics is still a limiting factor (Kashmiri *et al.*,2006; Nwuche and Ogbonna,2011; Patil *et al.*,2011). Thus, this led to the search for new lipases amongst the bacteria isolated from different water and soil temperature. Twenty eight thermoalkaliphilic bacterial isolates were picked up from different soil, water and slaughter house waste samples on the isolation medium (A) according to (Lima *et al.*, 2003) and nutrient agar medium (Shiriling and Gottlieb, 1966) at a temperature of 60°C and pH value of 10. Based on the calorimetrically, it was found that only one out of twenty eight bacterial isolates were best lipase producers. All cultures were tested at 60°C at pH 10 for 48 hrs.

3.3. Screening of thermoalkaliphilic lipase(s) forming bacterial isolates and selection for the most potent producing ones:

All the purified bacterial isolates were allowed to grow on medium (B) which was deprived from agar. The pH value was adjusted at 10, and the incubation was performed at 60°C for 48 hrs. Screening was achieved in three-way programs including monitoring of lipase production by all the isolated thermoalkaliphilic bacteria on the medium (B) which was supplemented with 1% of olive oil, 1% of slaughter house wastes and 1% of oily restaurant wastes separately. Only the group that was

supplement with slaughter house wastes had the ability to support the production of lipase enzyme by 7 isolates out of twenty eight bacterial isolates. The isolate number (18) - obtained from sandy soil obtained from Khormah, Khormah governorate slaughter house waste and isolate number (1) - obtained from slaughter house wastes derived from El Khormah governorate shown to be the most potent lipase producing isolates.

3.4. Identification of both the two most potent thermoalkaliphilic lipase(s) producing isolates

The most potent thermoalkaliphilic bacterial isolates (SHW-1) was subjected to the common morphological, physiological and biochemical investigations such as: Cultural characteristics, Gram stain, spore stain, and utilization of many carbon sugars according to the identification keys described in Bergey's manual of systematic bacteriology (Whitman, 2009). For further confirmed identification of the most potent isolate viz (SHW-1), 16S ribosomal RNA gene sequencing technique was performed. The sequence of the PCR product was compared with known 16S rRNA gene sequences in the Gene Bank database by multiple sequence alignment on: <http://www.ncbi.nlm.nih.gov/genbank/>. The results showing the sequence of isolate (SHW-1) had matching with genome of *B. stearothermophilus ste.a.ro.ther. mo'phi.lus*. Gr. n. *stear* fat; Gr. n. *therme* heat; Gr. adj. *philos* loving; N.L. adj. *stearothermophilus* (presumably Intended to mean) heat- and fat-loving- with the sequence similarity of 99.2%. Massadeh and Sabra (2011) produced and characterized of lipase from *B. stearothermophilus*.

3.5. Parameters Controlling lipase enzyme produced by the thermoalkaliphilic *B. stearothermophilus* KGSHW-18

In order to improve growth and / or favor the enzyme secretion, the influence of some key variable such as medium composition, and culture conditions were assessed. On the other hand, some factors such as culture pH, culture temperature and the addition of lipid compounds seemed to have great influence on the behavior of the microorganism. The characterization of lipase is based on pH, temperature of the production medium and enzyme. Many bacterial lipases are well studied compared to plant and animals. The organisms are normally grown nutrient medium containing carbon source (oil, sugar and mixed carbon sources), nitrogen, phosphorous sources and mineral salts, whereas the production of lipases mostly depends on inducer such as triglycerides, bile salts and glycerol. Patil *et al.*,(2011) mentioned the characteristics of some bacterial lipases in pH, temperature and molecular weight from both gram positive and gram negative

bacteria. It is evident from the **Patil et al., (2011)** results that , pH range is between 4.0 to 10.0; temperature range is between 27 to 80 °C, whereas molecular weight varies from 11 to 176kDa. Enzyme stability , which includes thermostability, oxidative stability and resistance to undesired aggregation and precipitation, is critical in industrial applications of biocatalysts and in biotechnology all of these factors contribute to the "robustness" of a protein.

3.5.a. Optimum incubation temperature and pH

Lipases are active over broad pH and temperature range and they have molecular weight ranging from 94 to 840 kDa. From available literature it can be interoperated that generally lipases have neutral pH optima but the pH and temperature optima of lipases depends on the habitat of its sources. Lipases possess stability over a wide range from pH 4 to 11 and temperature optima in the range from 10 to 96°C (**Patil et al.,2011**). Incubation temperature also plays an important role in the metabolic processes of an organism. Increasing temperature increased the rate of all physiological processes but beyond certain limits it started decreasing . A range of 40-85 °C was employed in the present study. Maximum lipase production was achieved at 60 °C. Data was recorded in table (1) explained that the production of *Geobacillus stearothermophilus* KGSHW-1. lipase(s) enzymes reached their optimal value 1350.73 (U/ml) at an incubation temperature 60°C. **Cherif et al.,(2011)** mentioned that, the increase in temperature seemed to have a negative effect on biomass production and also lipolytic activity. Decrease in lipase production can be associated to either decrease in cell growth or inactive nature of enzyme itself. **Shafei and Rezkallah (1998)** have reported similar results. **Kim et al., (2000)** reported a *B. stearothermophilus* that showed optimum growth at 55 °C , but showed almost no activity at the same temperature. On the other hand **Sifour et al.,(2010)** reported a *B. stearothermophilus* that produced high yields of lipase at 55 and 60 °C.

The effect of pH on the growth and enzyme production by *Geobacillus stearothermophilus* KGSHW-1 was assessed in a wide range of pH. Lipolytic productivities were found at maximum at initial pH 10, since the lipase yields reached up to 1477.9 (U/ml) .Below and above this particular value, the enzyme productivity decreased gradually. From this result , it was concluded that the microorganism needs neutral or alkaline pH values . For pH values outside this range, cell growth seems to be completely inhibited a fact which reveals the importance of studying this factor in cultures of *G. stearothermophilus* strain and the controlling the pH variations during its cultivation. **Kim et al.,(2000)**

isolated of bacterial lipase from *B. stearothermophilus* characterized by pH,7.4 ; temperature 68 and its molecular weight 43kDa. The culture medium for *Bacillus* cells growth is usually neutral to slightly alkaline (**Gupta et al.,2004;2005**). As it was demonstrated in a previous paper, the enzymatic synthesis can be greatly associated with cell growth . Thus , the highest values of enzyme production, maximum at pH 10, were also reached in the same range of pH values where the microorganism showed optimal growth.

3.5.b. Best buffer

pH plays a pivotal role in the biosynthesis of enzyme. Data recorded in table (2) showed that the usage of any of the three: Carbonate-bicarbonate, NaOH- Glycine or Borax- Sodium borate buffers had no positive effect on the productivity of lipase(s) enzyme by *B. stearothermophilus* SHW-1 since the enzyme(s) yields were less than harvested by using 6N NaOH for initial pH adjustment and used as control. The enzyme secretion was found to be high at pH 10.

3.5.c. Optimum incubation period and substrate concentration

Incubation period also affects the lipase production. Lipases are stable and rugged enzyme that act on lipids as well on wide variety of natural and artificial reactant since it has ability to catalyze diversified reaction (**Patil et al.,2011**). Lipases are often crucial to their application in industries and laboratories. Different lipases appear too specific in splitting various fatty acids. In this study it could be concluded from the results recorded in table (3) that the maximum lipase(s) productivity (1734.2 U/ml) was obtained after only 24 hrs. Beyond these maximum values, decline in the enzyme(s) productivity could be observed. It might be due to the exhaustion of nutrients in the substrate , which resulted in the inactivation of enzymes. This finding is in accordance with **Korn and Fujio(1997)**. **Tsujijsaka et al.,(1977)** the specificity of lipase is controlled by the molecular properties of enzyme, structure of substrate and factors affecting binding of enzyme to the substrate. Lipases act on substrate in specific and non-specific manner, resulting in complete hydrolysis of triglycerides into free fatty acids and glycerol or along with triglycerides, monoacylglycerides and diacylglycerides, fatty acids and glycerol's are also formed (**Aravindan et al.,2007**). It could be concluded best substrate concentration recorded in table (3) showed that the maximum lipase(s) productivity by *B. stearothermophilus* KGSHW-1 was obtained in the presence of (75%) of slaughter house wastes reaching (11205.84 U/ml). Similar results were obtained with *Bacillus* sp.(**Gupta et al.,2004;2005**). This study

revealed that enzyme secretion was associated with the growth of organism. Iftikhar *et al.*,(2011)

isolated fifteen bacterial strains capable of producing lipase enzyme from oily products.

Table (1):Relation of different incubation temperatures to lipases productivities by *B. stearothermophilus* KGSHW-1.

Incubation temperature (C°)	Lipase production (U/ml)	Initial pH value	Lipase production (U/ml)
40	915.1 ± 0.001	7	980.52 ± 0.015
45	950.2±002	7.5	1111.52 ± 0.015
50	977.07 ± 0.003	8	1112.4 ± 0.020
55	1200.2 ±002	8.5	1210.3±0.0015
60	1350.73 ± 0.003	9	1332.63 ± 0.001
65	1296.79 ± 0.004	9.5	1350.2±0.002
70	1225.37 ± 0.013	10	1477.89 ± 0.001
75	1123.68 ± 0.005	10.5	1350.2±0.002
80	1043.59 ± 0.012	11	1366.3 ± 0.002
85	1012.82 ± 0.012		

Table (2): Effect of using carbonate – bicarbonate, sodium hydroxide-glycine and borax-sodium borate buffer on lipases productivities by *B. stearothermophilus* SHW-1.

Na ₂ -bicarbonate Buffer	Lipase production (U/ml)	NaOH-Glycine buffer	Lipase production (U/ml)	Borax-sodium borate buffer	Lipase production (U/ml)
9.2	1012.82 ± 0.020	8.6	908.57 ± 0.001	9.3	918.7 ± 0.002
9.5	1033.23 ± 0.015	9	1044.59 ± 0.03	9.5	1000 ± 0.013
9.8	1086.08 ± 0.001	9.2	1055.33 ± 0.001	9.7	1035 ± 0.011
10	1119.08 ± 0.0003	9.4	1142.64 ± 0.005	9.9	1056 ± 0.001
10.2	1188.13 ± 0.002	9.6	1166.66 ± 0.002	10.1	1081 ± 0.002
10.3	1212.09 ± 0.001	10	1255.17 ± 0.004	10.2	1116 ± 0.002
10.6	1256.17 ± 0.004	10.4	1334.63 ± 0.001	Control	1605 ± 0.003
10.7	1398.85 ± 0.002	10.6	1213.09 ± 0.002		
Control	1605.03 ± 0.004	Control	1605.03 ± 0.001		

Table (3): Relation of different incubation periods to lipases productivities by *B. stearothermophilus* W-1.

Incubation period (hr)	Lipase production (U/ml)	Substrate concentration	Lipase production (U/ml)
6	1008.8 ± 0.001	0.125	1700.88 ± 0.004
12	1250.2±0.015	0.25	1594.94 ± 0.003
18	1366.3 ± 0.012	0.5	10378.62 ± 0.002
24	1734.2 ± 0.002	1	4058.06 ± 0.004
30	1724.2±0.015	2	1744.89 ± 0.005
42	1709.4 ± 0.004	5	1380.33 ± 0.002
48	1494.7 ± 0.002	10	2055.42 ± 0.003
66	1428.1 ± 0.004	20	2329.99 ± 0.052
72	1355.7 ± 0.002	50	7075.75 ± 0.003
75	1222 ± 0.004	75	17205.84 ± 0.012

3.5.d. Best nutritional conditions

The major factor for the expression of lipase activity has always been reported as the carbon source, since lipases are inducible enzymes (Gupta *et al.*, 2004). These enzymes are generally produced in the presence of lipid or any other inducer and glycerol (Ito *et al.*, 1998; Sharma *et al.*, 2009). After studying the efficacy of certain twenty various carbon source on the lipase(s) productivity by the bacterial strain, it was obvious that beef extract had a great inductive effect on *B. stearothersophilus* KGSHW-1 productivity, where the lipase(s) yields reached (16275.52 U/ml). The effect of different organic and inorganic nitrogen sources on lipase(s) productivity by the thermoalkaliphilic bacterial strain was studied. Eleven different nitrogen sources were applied and the data shown in table (4) revealed that the maximum productivity of lipase(s) by the strain *B. stearothersophilus* KGSHW-1 was induced by potassium nitrate reaching (15024.67 U/ml). Among twenty two amino acids introduced into the utilized production medium to grow the of thermoalkaliphilic strain, amino acid tryptophan was the best for optimum productivity of lipase(s) by *B. stearothersophilus* KGSHW-1 reaching (16275.52 U/ml). All results were listed in table (4).

3.5.e. Optimum inoculum size and incubation condition:

The number of cells in inoculum had great influence on the production of lipase by *G. stearothersophilus* KGSHW-1. As the number of cells increased, it consumed majority of the substrate for growth purpose, hence enzyme synthesis decreased. It was obvious from the results recorded in table (5) showed that the optimum inoculum size applied for the best lipase(s) productivity from the *B. stearothersophilus* KGSHW-1 was 1%(v/v) - of 7×10^{10} CFU.ml⁻¹ with lipase(s) yields of (95484.04 U/ml). Shaking condition was more inductive for productivities of lipase(s) enzymes by *B. stearothersophilus* KGSHW-1 the enzyme yields reached (49611.33 U/ml). It was designed to determine the best revolution rate for optimizing productivity of lipase(s) enzyme by the thermoalkaliphilic strain. Data recorded in table (5) showed that the best revolution rate to attain the highest productivity of lipase(s) by the *B. stearothersophilus* KGSHW-1 was 60 rpm where the enzyme yield reached 70744.75 (U/ml).

3.5.f. Optimal vitamin requirement and metallic ions:

The effect of applying of different vitamins separately on lipase(s) productivity by the thermoalkaliphilic bacterial strain was studied. Data recorded in table (6) showed that vitamin B₆ was the

best inductive agent *B. stearothersophilus* KGSHW-1. The maximal lipase(s) productivity reached (28203.43 U/ml) at a concentration of 100 ppm. Results listed in table (6) showed that, the lipase(s) productivity by *B. stearothersophilus* W-1 had the highest yield by applying barium chloride where it reached the value 28486.77 (U/ml). The activity of lipases may be inhibited or stimulated by cofactors. Divalent cations such as calcium often stimulated enzyme activity due to the formation of calcium salts of long chain fatty acids (Macrae and Hammond, 1985). Calcium stimulated lipases have been reported in the case of *Acinetobacter* sp. RAG1 (Snellman and Colwell, 2004). In contrast, the lipase from *Pseudomonas aeruginosa* 10145 is inhibited by the presence of calcium ions. Further lipases activity is inhibited drastically by heavy metals like Ca⁺², Ni⁺², Hg⁺² and Sn⁺² and slightly inhibited by Zn⁺² and Mg⁺² (Patkar and Bjorkling, 1994).

Pseudomonas aeruginosa KKA-5 lipase hydrolyze castor oil in the presence of various metal chlorides. CaCl₂, AlCl₃, CrCl₃ and MgCl₂ displays enhanced hydrolysis capability. When Cr⁺³ were used, hydrolysis of castor oil was four times faster than that of calcium and 1.6 times faster with regards to Al⁺³. The presence of chloride salts of Mg⁺², Cu⁺², Ca⁺², Hg⁺² and Fe⁺² result in a profound increase in the hydrolytic activity of the purified lipase. Interestingly, Hg⁺² ions resulted in a maximal increase in lipase activity but Co⁺² ions showed as antagonistic effect. The EDTA at concentration of 150mM markedly inhibited the activity of lipase.

Lipase activity was enhanced in the presence of K⁺ and Ca⁺² and Mg⁺² ions, but inhibited by Hg⁺² ions (Sharma *et al.*, 2009; 2001). The addition of Mg⁺² did not significantly stimulate lipase production. While many other metal ions including Ca⁺², Mn⁺², Ba⁺², Zn⁺², metal ions, including Ca⁺², Mn⁺², Ba⁺², Zn⁺², and Cu⁺² exerted inhibitory effects. However, lipase production was decreased slightly, to approximately 5% with the addition of K⁺ and 30% decrease was observed in lipase production in an absence of potassium ions. The absence of magnesium ions (Mg⁺²) in the basal medium was also shown to stimulate lipase production. The lipase activity in presence of a metal ion whose activity was taken as 100% and the relative activities at 1mM of Cu⁺², Hg⁺², Pb⁺², Co⁺², Cd⁺² and Li⁺ were 0.44, 24.4, 36.2, 49.1, 64.2, 90.0 and 98.2 % respectively. Annamalai *et al.*, (2011) found that, metal ions, Ni⁺², Mn⁺², Hg⁺², Fe⁺², Fe⁺³ and Co⁺² were slightly inhibited enzyme activity and no effect was found with Cu⁺².

Table (4): Effect of applying various carbon, nitrogen and amino acid sources on lipases productivities by *B. stearothermophilus* KGSHW-1.

Carbon sources	Lipase activity (U/ml)	Nitrogen sources	Lipase activity (U/ml)	Amino acids	Lipase activity (U/ml)
Rhamnose	7800.76 ± 0.011	Sodium nitrite	14715.57 ± 0.004	Control	3859.32 ± 0.004
Xylose	1366.3 ± 0.001	Pot. nitrate	15024.67 ± 0.003	Ornithine	1044.59 ± 0.071
Galactose	10915.54 ± 0.031	Amm. nitrate	10539.38 ± 0.004	Histidine	935.35 ± 0.003
Melezitose	8756.48 ± 0.004	Peptone	11079.38 ± 0.002	Arginine	1005.77 ± 0.002
Mannitol	1788.003 ± 0.032	Amm. phosphate	9488.56 ± 0.002	Lysine	1046.76 ± 0.062
Glucose	1738.2 ± 0.022	Sodium nitrite	14715.57 ± 0.004	Phenylalanine	1194.08 ± 0.032
Cellobiose	1449.63 ± 0.003	Calcium nitrate	14366.81 ± 0.005	Alanine	1825.08 ± 0.007
Maltose	899.56 ± 0.002	Urea	13130 ± 0.005	Aspartic acid	875.07 ± 0.003
Ribose	9488.56 ± 0.003	Amm. chloride	14080.49 ± 0.004	Glycine	1635.25 ± 0.008
Sucrose	1366.3 ± 0.003	Amm. molybdate	12555.56 ± 0.007	Cysteine	1025.97 ± 0.081
Dextrin	6267.39 ± 0.002	Amm. sulphate	13199.78 ± 0.004	Threonine	1169.07 ± 0.072
Starch	4017.72 ± 0.003			Citruline	1333 ± 0.002
Inuline	2628.8 ± 0.004			Serine	1093.51 ± 0.005
Pectin	2935.99 ± 0.003			Valine	1438.22 ± 0.046
Sorbitol	3669.95 ± 0.003			Proline	1805.32 ± 0.073
Lactose	3579.64 ± 0.0004			Tryptophan	16275.52 ± 0.064
Beef extract	16275.52 ± 0.002			Glutamic acid	888.43 ± 0.009
Sugar cane molasses	1399.83 ± 0.004			Methionine	1317.4 ± 0.002
Cellulose	4660.66 ± 0.005			Asparagine	1585 ± 0.001

Table (5): Effect of applying various inocula sizes, incubation conditions and shaking speed on lipases productivities by *B. stearothermophilus* KGSHW-1.

Inoculum Size (%)	Lipase production (U/ml)	Incubation condition	Lipase production (U/ml)	Revolution speed (rpm)	Lipase production (U/ml)
0.25	5477.46 ± 0.018	Static	28488.77 ± 0.001	60	70744.75 ± 0.0095
0.5	49619.33 ± 0.003	Shaking (100 rpm)	49611.33 ± 0.012	90	46959.41 ± 0.00
1	95484.04 ± 0.012			120	44235.88 ± 0.002
2	33095.93 ± 0.005				
4	30098.77 ± 0.017				
5	6928.05 ± 0.002				
10	8218.56 ± 0.039				

3.5.g. Optimum bottle capacity

Data recorded in table (8) showed that the optimum productivity of lipase(s) by the strain *B. stearothermophilus* KGSHW-1 was in the 250 ml Erlenmeyer flask containing with 2.5% of its capacity where the enzyme yield reached (63378.33 U/ml). Data recorded in table (8) showed a summary of the optimal environmental and nutritional conditions for optimum productivities of lipase(s) enzyme by both the two thermoalkaliphilic *B. stearothermophilus* KGSHW-1 grown on slaughter house wastes. According to Davranov (1994) extensive and persistent screening for new microorganisms and

their lipolytic enzymes will open new, simple routes for synthesis processes and consequently new and faster ways to solve environmental problems.

3.6. Purification and molecular weight of thermoalkaliphilic lipase

A summary of the purification steps of lipase enzymes produced by both the two thermoalkaliphilic strain *B. stearothermophilus* KGSHW-1 were presented in table (9). The protein sample related to the strain *B. stearothermophilus* KGSHW-1 also was detected in one sharp band of molecular weight 60 kD, compared with the utilized protein marker.

Table (6):Effect of applying different concentrations of various vitamins and metallic ions on lipases productivities by *B. stearothermophilus* KGSHW-1.

Vitamin conc. (ppm)	Lipase production (U/ml)	Metallic Ion (500 ppm)	Lipase production (U/ml)	
Nicotinic acid	25	4019.72 ± 0.004	Control	16198.37 ± 0.091
	50	4188.54 ± 0.002	Na ₂ MoO ₄ ·2H ₂ O	13595.42 ± 0.061
	100	4267.94 ± 0.053	BeSO ₄	4109.2 ± 0.003
	250	4440.88 ± 0.004	CuSO ₄	17285.53 ± 0.004
	500	5210.57 ± 0.002	CaSO ₄	11646.04 ± 0.0095
	1000	5680.38 ± 0.002	NiSO ₄	27238.76 ± 0.0027
Riboflavin	25	6588.49 ± 0.0095	ZnSO ₄	5447.17 ± 0.003
	50	7133.35 ± 0.003	FeSO ₄	12679.64 ± 0.035
	100	10599.18 ± 0.012	MnSO ₄	12070.63 ± 0.084
	250	9535.09 ± 0.035	MgSO ₄	25145.73 ± 0.042
	500	11880.18 ± 0.092	FeCl ₃	8633.15 ± 0.00
	1000	12740.57 ± 0.002	MnCl ₂	13995.3 ± 0.017
Vitamin B6	25	19301.07 ± 0.053	CaCl ₂	7468.1 ± 0.053
	50	19512.29 ± 0.080	MgCl ₂	12928.62 ± 0.0095
	100	28203.43 ± 0.052	ZnCl ₂	4558.18 ± 0.014
	250	26410.73 ± 0.091	CoCl ₂	26169.33 ± 0.001
	500	26199.24 ± 0.002	BaCl ₂	28486.77 ± 0.003
	1000	26719.83 ± 0.006	CuCl ₂	14945.77 ± 0.002
Myristic acid	25	14366.81 ± 0.005	EDTA	16280.52 ± 0.002
	50	11080.38 ± 0.003	Na ₂ S ₂ O ₃	18730.26 ± 0.013
	100	9490.56 ± 0.003		
	250	12366.78 ± 0.004		
	500	11134.88 ± 0.004		
	1000	13218.44 ± 0.007		
Ascorpic acid	25	20793.92 ± 0.015		
	50	25268.7 ± 0.027		
	100	14150.04 ± 0.038		
	250	11999.52 ± 0.055		
	500	17113.64 ± 0.069		
	1000	17315.19 ± 0.003		

Table(7):Relation of bottle capacity to lipases productivities *B. stearothermophilus* KGSHW-1.

Bottle Capacity	Content vol. (%)	Lipase Production (U/ml)
1000 ml	2.50%	15877.83 ± 0.001
	5%	20689.27 ± 0.009
500 ml	2.50%	13195.78 ± 0.041
	5%	24158.33 ± 0.002
250 ml	2.50%	63378.33 ± 0.064
	5%	15795.69 ± 0.003
100 ml	2.50%	6656.66 ± 0.012
	5%	9729.62 ± 0.093

Table (8): A summary of the optimal environmental and nutritional parameters controlling the productivities of lipases produced by *B. stearothermophilus* KGSHW-1.

Parameter	<i>B. stearothermophilus</i> KGSHW-1	Parameter	<i>B. stearothermophilus</i> KGSHW-1
Temperature (°C)	60	Substrate concentration (%) w/v	75
pH	10	Inoculum size (%) v/v	1
Incubation period (hrs)	24	Vitamin (ppm)	Vitamin B6
Carbon source	Beef Extract	Metallic ion (500 ppm)	BaCl ₂
Nitrogen source	Potassium nitrite	Shaking/ Static conditions	Shaking (60rpm)
Amino acid	Tryptophan	Bottle capacity	2.5% of 250 ml capacity

Table (9):A summary of purification steps of lipase produced by *B. stearothermophilus* KGSHW-1.

Purification Step	Volume (ml)	Protein content (mg/ml)	Total Protein (mg)	Lipase Activity (U/ml)	Total Activity (U)	Specific Activity (U/mg protein)	Purification fold	Yield (%)
CFF	500	0.436	218	6753.2	3376580	15489	1	100
Precipitation by Acetone	100	0.704	70.40	22650	226502	32311	2.086	77
Dialysis against sucrose	7	1.146	8.099	42703.41	298923.8	36908.72	1.44	8.4
Sephadex G-200	5	0.0431	0.2155	9972.8	49863.75	231942	14.92	2.4
Sephadex G-100	5	0.0060	0.0253	3209	16045	617108	39.88	0.5

4. Conclusion

Most commercial lipases produced from microbes. In this study, thermophilic and alkaliphilic bacteria with lipase enzyme producer were identified from Khormah governorate slaughter house wastes, soil and water samples collected from different localities around this slaughter house. The slaughter house wastes diversity is large and that most microbiologists seek to isolate thermophiles and alkaliphiles from "hot" environments seems to be worth since these environment have proved to be the home for bacteria and useful enzymes. Morphological, biochemical, physiological and molecular biology techniques can be used to identify both the bacteria and the enzymes being expressed. The results obtained in this study permit to conclude that pH is a highly significant factor in growth of newly isolated *B. stearothermophilus* strain, with an optimal growth and lipolytic enzyme production at pH and a wide range of temperature from (40 to 85°C). The study of the characteristics of this lipase showed its potential for the use in many application, as it is thermostable, pH tolerant and can withstand a number of meta ions.

Corresponding author:

Prof. Dr. Reda Ahmed Bayoumi, Biotechnology Dept., Faculty of Science, Taif University (Khormah Branch), Kingdom of Saudi Arabia (KSA).

E mail: reda.elbayoumi@yahoo.com

References

- Abdul-Hamid, N., Zen, H.B., Tein, Q.B., Yasin, M., Halifah, Y.M., Saar, N.I. and Bakar, F.A. (2003): Screening and identification of extracellular lipase-producing thermophilic bacteria from a Malaysian hot spring. *World J. Microbiol. Biotechnol.* 19:961-968.
- Akatsuka, H., Kawai, E., Lami, Y., Sakurai, N. and Omari, K. (2003): The *Serratia marcescens* BioH gene encodes an esterase. *Gene*, 302(1-2):185-192.
- Annamalai, N., Elayaraja, S., Vijayalakshmi, S. and Balasubramanian, T. (2011): Thermostable, alkaline tolerant lipase from *Bacillus licheniformis* using peanut oil cake as a substrate. *Afric. J. Biochem. Res.* 5(6):176-181.
- Aravindan, R., Anbumathi, P. and Viruthagiri, T. (2007): Lipase application in food industry. *Indian J. Biotechnol.* 6,141-158.
- Brown, A.E. (2005): Banson's Microbiology Application: Laboratory Manual in General Microbiology. (9th Ed.) New York: McGraw-Hill.
- Buchanan, R.E., Gibbons, N., Cowan, S.T., Holt, T.G., Liston, J., Murry, R.G., Niven, C.F., Rabin, A.W. and Stainer, R.Y. (1974): Bergey's manual of determinative bacteriology. Williams and Wilkins Co., Baltimore.
- Castro-Ochoa, L.D.; Gómez, C. R.; Alfaro, G. A.; and Ros, R. A. (2005): Screening, purification and characterization of the thermoalkalophilic lipase produced by *Bacillus thermoleovorans* CCR11. *Enzyme and microbial technology* 37, pp.648-654.
- Cherif, S., Mnif, S., Hadrich, F., Abdelkafi, S. and Sayadi, S. (2011): Strategy for improving extracellular lipolytic activities by a novel thermotolerant *Staphylococcus* sp. strain. *Lipids in Health and Disease* 10:209.
- Davranov, K. (1994): Microbial lipases in biotechnology (Review). *Appl. Biochem. and Microbiol.* 30,427-432.
- Deutcher, M. P. (1993): Guide to Protein Purification. *Methods in Enzymology*. Vol. 182. Academic Press, Inc.
- Dominguez, A.; Pastrana, L.; Longo, M.; Rua, M.; and Sanroman, M. (2005): Lipolytic enzyme production by *Thermus thermophilus* HB27 in a stirred tank bioreactor. *Biochemical Engineering Journal*. 26: 95-99.
- Dox, A. W. (1910): The intracellular enzymes of *Penicillium* and *Aspergillus* with special reference to those of *P. camemberti*. *US Sept. Agr. Bur. Animal/ Ind. Bull.*, 120-170.
- Eggert, T., Pencreac'h, G., Douchet, I., Verger, R. and Jaeger, K.E. (2000): A novel extracellular esterase from *Bacillus subtilis* and its conversion to a monoacylglycerol hydrolase. *Eurp. J. Biochem.* 26(2):6459-6469.
- Eggert, T., Pouderoyen, G., Dijkstra, B., Jaeger, K. (2001): Lipolytic enzymes LipA and LipB from *Bacillus subtilis* differ in regulation of gene expression, biochemical properties and three-dimensional structure. *FEMS Lett.* 502:89-92.
- Ghori, M.I., Iqbal, J. and Hameed, A. (2011): Characterization of a novel lipase from *Bacillus* sp. isolated from tannery wastes. *Braz. J. Microbiol.* 42:22-29.
- Gupta, R., Gupta, N., and Rathii, P. (2004): Bacterial lipase: An overview of production, purification and biochemical properties. *Appl. Microbiol. Biotechnol.* 66(6):764.
- Gupta, N., Rathii, P., Singh, R., Goswami, V.K. and Gupta, R. (2005): Single-step purification of lipase from *Burkholderia multivorans* using polypropylene matrix. *Appl. Microbiol. Biotechnol.* 67,648-653.
- Hassan, F., Shah, A.A.; Hameed, A. (2006): Industrial applications of microbial lipases. *Enzyme Microbiol. Technol.* 39,235-251.
- Hasan, F., Shah, A.A., and Hameed, A. (2007): Purification and characterization of a mesophilic lipase from *Bacillus subtilis* FH5 stable at high temperature and pH. *Acta Biol. Hung.* 58,115-132.
- Horchani, H., Mosbah, H., Salem, N., Gargouri, Y. and Sayari, A. (2009): Biochemical and molecular characterization of a thermoactive *Staphylococcus aureus* strain. *J. Mol. Catal. B. Enzyme* 56(4):237-245.
- Iftikhar, T., Niaz, M., Anjum, M., Jabeen, R. and Aftab, M.N. (2011): Biosynthesis of extracellular lipases by *Bacillus*

- sp.(MBLB-3) in relation to the nutritional conditions. Pak.J.Bot.43(5):2587-2591.
- Ito,S.,Kobayashi,T. and Ara,K.(1998):** Alkaline detergent enzymes from alkaliphiles enzymatic properties, genetics and structures. *Extremophiles*.2,185-190.
- Jaeger,K.F. and Eggert,T.(2002):** Lipases for biotechnology. *Cur. Opin. Biotechnol*.13:390397.
- Jaeger,K.E.,Dijkstra,B.W. and Reetz,M.T. (1999):** Bacterial biocatalysts: molecular biology, three-dimensional structure, and biotechnological applications of lipases. *Annu. Rev. Microbiol*. 53:315-351.
- Kashmiri,M.A.,Adnan,A. and Butt, B. W. (2006):** Production, purification and partial characterization of lipase from *Trichoderma viride*. *Afric.J.Biotechnol*.5,878-882.
- Kim,H.K.,Park,S.Y.,Lee,J.K. and Oh,T.K.(1998):** Gene cloning and characterization of thermostable lipase from *Bacillus stearothermophilus* L1. *Biosci. Biotechnol*.62:66-71.
- Kim,M.,Kim,H.,Lee,J. and Oh, T. (2000):** Thermostable lipase of *Bacillus stearothermophilus*: high level production, purification and calcium dependent thermostability. *Biosci. Biotechnol. Biochem*. 64 (2): 280-286.
- Kim,H.K.,Chio,H.J.,Kim,M.N.,Sohin,S.B. and Oh,T.K.(2002):** Expression and characterization of Ca²⁺ independent lipase from *Bacillus pumilus* B26. *J.Biochem. Biophys. Acta*. 11(83):205-212.
- Korn,M.S. and Fujio,Y.(1997):** Effect on the degree of maceration of soybean fermented by *Rhizopus* strain. *J.Fac.Agric*,41(3-4):231-237.
- Laemmli, U. K. (1970):** Cleavage of structural proteins during the assembly of the head of bacteriophage T4. *Nature*. 227(259): 680-685.
- Lee,D.W.,Koh,Y.S.,Kim,K.J.,Kim,B.C.,Choi,H.J.Kim,D.S.,Suh artono,M.T. and Pyun,Y.P.(1999):** Isolation and characterization of a thermophilic lipase from *Bacillus thermooleovorans* ID-1. *FEMS Microbiol. Lett.*, 179:393-400.
- Lima, N.;Chirumamila, R. and Marchant, R.R.(2003):** Production, regulation and some properties of lipase activity from *Fusarium oxysporum* f. sp. *Vasinfestum*. *Enz. Microbiol. Technol.*, 18, pp. 932-938.
- Lima, V. M. G.; Krieger, N.; Mitchell, D.A. and Fontana,J.D. (2004):** activity and stability of a crude lipase from *Penicillium aurantiogriseum* in aqueous media and organic solvents. *Biochem. Eng. J*, 18, pp. 65-71.
- Littechild,J.A.,Guy,J.,Connelly,S.,Mallett,J.,Waddell,S.,Rya,C. A.,Line,K.,Ilsupov.M.(2007):** Natural methods of protein stabilization; thermostable biocatalysts. *Biochem.Soc.Trans*.35:1558-1563.
- Lowry, O. H.; Rosebrough, N. G.; Farr, A. L. and Randall, R. J. (1951):** Protein Measurement with the Folin phenol reagent. *J. Bio Chem*. 193. pp. 265- 275.
- Macrae,A.R. and Hammond,R.C.(1985):** Present and future application of lipases. *Biotech. Genet. Eng.Rev*.3,193-219.
- Massadeh,I.M. and Sabra,F.M.(2011):** Production and characterization of lipase from *Bacillus stearothermophilus*. *Afric.J.Biotechnol*.10(61): 13139-13146.
- Meghwanshi,G.,Agarwall,L.,Dutt,K.andSaxena,R.(2006):** Characterization of 1-3,regiospecific lipases from new *Pseudomonas* and *Bacillus* isolates. *J.Mol.Catal.B.Enzyme*.40:127-131.
- Nwuche,C.O. and Ogonna,J.C.(2011):** Isolation of lipase producing fungi from palm oil mill effluent (POME) dump sites at Nsukka. *Braz. Arch.Biol. Technol*.54(1):113-116.
- Nawani,N. and Kaur,J.J.(2001):** Purification, characterization and thermostability of lipase from a thermophilic *Bacillus* sp. J33. *Mol. Cell. Biochem.*, 206,91-96.
- Nawani,N. and Kaur,J.J.(2007):** Purification , characterization and thermostability of lipase from a thermophilic *Bacillus* sp.J33. *Mol.& Cellular Biochem*.206,91-96.
- Pahoja,V.M. and Sethar,M.A.(2002):** A review of enzymatic properties of lipase in plants, animals and microorganisms. *Park.J. Appl.Sci*.2,474-484.
- Patil,K.J., Chopda,M.Z. and Mahajan,R.T.(2011):** Lipase biodiversity (Review). *India.J. Scien. Technol*. 4(8):971-982.
- Patkar,S. and Bjorkling,F.(1994):** In: *Lipases: Their structure, biochemistry and application*. Woolley,P. and Patersen(eds.),pp:77.
- Posorsk,L.H.(1984):** Industrial scale application of enzymes to the fat and oil industry. *J.Amer.Oil Chem.Soc*.61,1758-1760.
- Rahman,R.N.,Leow,T.C. and Shalleh,A.B.(2007):** *Geobacillus zalihae* sp. nov., a thermophilic lipolytic bacterium isolated from palm oil mill effluent in Malaysia, *BMC Microbiol*.7:77.
- Ruiz,B.,Farres,A.,Langley,E.,Masso,F. and Sanchez,S.(2001):** Purification and characterization of an extracellular lipase from *Penicillium candidum*. *Lipids*.36,283-289.
- Ruiz,C.,Blanco,A.,Pastor,F.I. and Diaz,P.(2002):** Analysis of *Bacillus megaterium* lipolytic system and cloning of Lip A, a novel subfamily 1.4 bacterial lipase. *FEMS Microbiol.Lett*.217,263-267.
- Sambrook, J.; Fritsch, E. F.; and Maniatis, T. (1989):** *Molecular Cloning: A laboratory manual*. 2. ed., 3. vol., Cold Spring Harbor Laboratory Press, New York, 253p.
- Schmidt-Dannert,C.,Rua,M.L.,Atomi,H. and Schmid, R. D. (1996) :** Thermoalkaliphile lipase of *Bacillus thermocatenulatus*.I. Molecular cloning, nucleotide sequence, purification and some properties. *Biochimica. Biophysica. Acta.*, 1301:105-114.
- Shafei,E.H.A. and Rezkallah,L.A.(1998):** Production, purification and characterization and extracellular lipase of *Bacillus cereus*. *Bull.Natl.Res.Cent*.23(1):23-41.
- Sharma,R.,Chisti,Y.,Banerjee,U.C.(2001):** Production, purification, characterization and applications of lipases. *Biotechnol. Adv.* , 19: 627-662.
- Sharma,A.,Bardhan,D. and Patel, R.(2009):** Optimization of physical parameters for lipase production from *Arthrobacter* sp. BGCC# 490. *Indian J.Biochem.Biophysic*.46(2):178-183.
- Shirling, E. M. and Gottlieb, D. (1966):** Methods for characterization of *Streptomyces* sp. *Int. J. Syst. Bact.*, 16: 313-340.
- Sifour,M.,Zaghloul,T.I.,Saeed,H.M.,Berekaa,M.M. and Abdel-fattah, Y. R. (2010):** Enhanced production of lipase by the thermophilic *Geobacillus stearothermophilus* strain-5 using statistical experimental designs. *N. Biotechnol*. 27(4):330-336.
- Soliman, A. M. (2003):** Microbial thermostable proteases from environmental wastes produced under solid state fermentation conditions. M. Sc. Thesis. Botany & Microbiology Dep., Faculty of Science, Al- Azhar University, Cairo, Egypt.
- Snellman,E.A. and Colwell,R.R.(2004):** *Acinetobacter* lipases: molecular biology, biochemical properties and biotechnological potential. *J. Industrial Microbiol. Biotechnol*, 31, 391-400.
- Tsujisaka,Y.,Okumura,S. and Iwai,M.(1977):** Glyceride synthesis by four kinds of microbial lipase. *Biochim.Biophys.Acta*,489,415-422.
- Vijayaraghavan,P.,Kumar,T.S.,Viveka,S. and Vincent, S.G.(2011):** Biosynthesis , optimization and purification and acid lipase from *Bacillus* sp. *J.Appl.Sci.Res*.7(8):1306-1314.
- Whitman, W. B. (2009):** *Bergey's Manual of systematic bacteriology*. 2nd Edition, Vol. 3; the Firmicutes. Springer Dordrecht Heidelberg London New York.
- Woo, P.C.Y.;Leung, P.K.L.; Leung, K.W.; and Yuen, K.Y.(2000):** Identification by 16S ribosomal RNA gene sequencing of an Enterobacteriaceae species from a bone marrow transplant recipient. *Clin. Pathol. Mol. Pathol.*; 53. pp.211-215.
- Zuridah,H.,Norazwin,N.,Siti Aisyah, M., Fakhruzzaman, M.N.A. and Zeenathul, N.A. (2011):** Identification of lipase producing thermophilic bacteria from Malaysian hot springs. *Afric. J. Microbiol. Res*.5(21):3569-3573.

Intellectual capital management, a paradigm to enhance the human resource management in knowledge-based economy

Ali Atashi^{1*}, Hossein Kharabi²

1-Young researchers club, Astara Branch, Islamic Azad University, Astara, Iran

2-Msc in management, Astara Branch, Islamic Azad University, Astara, Iran

The research is financed by Young researchers club, Astara Branch, Islamic Azad University, Astara, Iran

Cores ponder EMAIL: ali_atashi_1316@yahoo.com

Abstract: Labor force which is qualified, innovative, dynamic and knowledgeable is the most important competitive advantage in organizations and rarest resource in today's knowledge-based economy. Offering different and distinct qualified products and services, reducing the costs, increasing the productivity, creativity and competitiveness are some advantages of qualified and knowledgeable human resources. Therefore, undoubtedly, the present era is the era of organizations, and trustees of these organizations are the human beings. Intellectual capital is raised as one of the most valuable resource in companies, and a key capital in the growth of entrepreneurship. Hence, today the necessity for development and management is considered as a serious requirement in vast national level and the entrepreneurship area, and moving towards a knowledge-based economy has led to a change in the dominant paradigm in industrial economy. So that today we can see the emerging of knowledge-based and information-based economy whose foundation is based on intellectual capital. In the knowledge-based economy, intellectual capital is used to create value for the organization. In today's world, the success of any organization depends upon the ability to manage these assets. Today, we can see the growing importance of intellectual capital as an effective tool for increasing companies' competitiveness. Even intellectual capital measurement is necessary to compare different companies to determine their true value or improving their controls. This paper attempts to address intellectual capital, intellectual capital management objectives, measurable goals of intellectual capital, elements of intellectual capital, methods of measurement in organizations, interactions between organizations, quality management, human resources and quality, status, importance and necessity of capital management and human resource development, and through this study the place, importance and necessity of capital management and human resource development, new roles and functions of human resource management in the knowledge economy in the 21st century. The results suggest that in the present age, the availability of knowledgeable human resources are considered as the most important capability of the organization in acquiring competitive advantage, and also the main intangible asset, and the organizations believe that the employee must be regarded as the basis for improving quality and productivity in all organizational processes. Leading organizations by their efforts to attract, develop, retain and employ qualified and knowledgeable personnel ensure the competitive advantage for today and tomorrow. [Ali Atashi, Hossein Kharabi. **Intellectual capital management, a paradigm to enhance the human resource management in knowledge-based economy.** *Life Sci J* 2012;9(4):1336-1340] (ISSN:1097-8135). <http://www.lifesciencesite.com>. 202

Keywords: human resource management, knowledge-based economic, human resource development, human capital, intellectual capital.

1. Introduction

Human resource development is such as a coin with two sides. It means that as it emphasizes on strengthening human capabilities through investment, it also highlights the effective use of human capabilities in creating a cooperative framework for improving income and employment. In fact, the human resource development is a continuous series of formal and informal activities which by making change in paradigms and subjective patterns and improving self-consciousness in persons and promoting their capabilities and leading them to self-actualization, increases productivity, and maintain and improve an organization's competitive advantage. Research in the field of human resources, labor

organizations seeking to increase their knowledge base progress of their human forces, and participation and consultation of their human forces in organizational affairs, enjoy much more synergy compared to static and traditional organizations which keep the channels between individuals closed, and make limitation for the information processes between their employees.

Nonetheless, by the scientific and technological advances, gradually the economic activities of communities become more 'knowledge intensive' and knowledge-based economy is formed. One characteristic of the knowledge economics is expanded workforce that will deal with scientific instruments. This expansion of the work force is both

quantitative, that means the number of knowledge workers is increased, and qualitative which means the quality of the workforces is promoted. Knowledgeable workforce which is now the main body of human capital and intellectual capital in economic systems is now regarded as the most essential capital in the societies. The experiments in knowledge-based economies show that the intellectual capital significantly exceeds the financial and physical capitals. And in these societies, knowledge, science, and knowledge creation is the main factor in survival and development of organizations in competitive circumstances.

Today, the words related to human resources in knowledge-based economy has differed, and in many of the scientific literature, the terms mental capital and mental power are used rather than labor force. According to the 1994 Human Development Report, United Nations Development Programme (UNDP), any action that strengthens the worldwide movement for development of human resource development, particularly in developed countries and developing countries is a human effort that is worthy. The concept of intellectual capital has always been ambiguous. Therefore, researchers have attempted to define and measure the category that has not ever been measured. Different definitions of intellectual capital are presented in different sources:

The term "intellectual capital" was introduced for the first time by John Kenneth Galbraith in 1969. Before that, Peter Drucker called "knowledge workers" to be used. In a simple definition, intellectual capital is the difference between market value and book value of a company's assets. According to this definition, intellectual capital is the processes and assets which are usually not reflected in the balance sheet.

2. The history of human resource management

If we study the history of human resource management, we will see the field has had many ups and downs in today's world. This field has found its place difficultly, and today it is to find the real position. But the general trend in human resource management is ? with development in management schools. As schools of management developed, human resource management has also been developed. Human resource management is primarily rooted in the neoclassical school. The school leaders, also known as behaviorism, are people like Maslow, Mayo, Owen, Burg, and more. Neoclassicals revised the classical concepts, and put the human rather than the technical aspects, as the dominant organizational aspect, and used the term Social & Technical which has both the technical aspects and the human dimension. Shortly, the history of development of

human resource management is divided into six periods.

1. age of welfare

In this period (1910-1915), the traditional approach to human resource development, was in the least important place. A unit which called welfare unit was in the organizations that only dealt with staff affairs. In this period, the human resource unit was expected to deal with the staff affairs, simple and public affairs activities that were in connection with the employee.

2. Age of supervision on staff

The period between first and second world wars, which is roughly correspond to the neoclassical school, in which the employee in their organizations are considered as an important issue to be paid attention to. The staff was not previously considered as a separate category. Issues such as insurance and retirement were introduced in this period. And issues related to the recruitment and retention of documents and records are related to that period.

3. Personnel management age

In this period (1940-1960), the concept of management went beyond the supervision. It means for human force, planning, evaluating, organizing and so on are performed. In this period, in addition to the previous duties of employees' evaluation, payment of salary and incentive plans in payments system was also added to the human resource management function.

4. Advanced management age

In this period (1960-1980), in addition to the previous tasks, dealing with affairs such as employee disciplinary matters, manpower planning, recruitment and human resources were included in the tasks of human resource management.

5. Entrepreneur age

In this period (1980-1990), in general, a person is said to be entrepreneur who recognizes the opportunities and uses them in appropriate situations (Drucker, 2001). In this period, in addition to the previous tasks of human resource management, it was expected to identify, recruit, and train entrepreneurs, since the organizations owe their life to them because of their creativeness and innovativeness. It is said that in this period human resource management field has been a challenge issue. It means that if organizations are dealing with this scope well, good opportunities will be made, but if they have not appropriate interaction, it would be considered as a threat to them. In this period, in addition to the previous tasks, human resource management is involved with organizational strategies and tactics.

6. Meta entrepreneurship age

In this period, no the strategy can not be compiled unless the human resource management unit confirms it, because the key factor of success for organizations is the human factor. In this period, human resource managers reach to the position of strategic partners to the organization. According to this, the second salary after the chief executive officer is paid to human resource manager. So the subject of "Human Resource Accounting" is discussed.

3. Importance and necessity of developing human resources

The results of numerous studies on the role and importance of human resources in development of organizations and sometimes growth of societies insisted that any society is not developed, unless it deals with human resource development. The developed countries have developed organizations, and developed organizations have developed managers, and developed managers develop human resource of organizations. However, today, qualified and skilled manpower are considered as a valuable factor and endless resource for development of organizations and countries. So that during the last half century, a considerable part of the developed countries owe to the change in their skilled manpower. If in the past, labor, capital and land were considered the main factors of production, today, applying technology, human factors and increased productivity are considered as development factors.

Valuable experiences of leading successful organizations on human values indicate the importance of human capital employed in organizations. At present, in all developed countries, the human force that has progressive features, ensures the organization's survival. If we want the effectiveness, expansion, permanentness, and survival, this unwritten rule should be written and applied by managers and company officials.

They know the magnitude of their organization as those who work for them, the core of their business development is based on their staff, they know humans as the sources of creativity, innovation, power and beauty, and believe if the conditions for people working in their organization are provided, their abilities would be manifested. They believe that success or failure of any organization or institution is based on the loyalty and competence of its personnel. And finally think that if the organization does not deserve to keep its loyal and technical forces, or does not choose appropriate personnel to maintain their highest values, it will gently decline. Therefore, if an organization wants sustainable growth, survival and effectiveness in today's competitive arena, it should deals with development and optimization of its human resources in knowledge-based economy.

4. Knowledge-based economics

Knowledge economics or knowledge based economics includes all **jobs, industries, and companies in which knowledge and capabilities of people** are crucial in competitive advantage, rather than machines and technology capabilities. It is anticipated that from 19/5 million jobs that is to be created between 1998 and 2008 in the U.S., 19 million is in the service sector. although the number of knowledge-based works in the service sector is higher, with the arrival of computers and microprocessor, manufacturing sector is more than ever dependent on the knowledge and human capabilities. Knowledge economy is the result of commercialization of information and communication technologies.

5. Development of human resource management in the knowledge-based economy

Knowledge-based economy has less reliance on physical accumulation of manpower, raw materials and money. In the past, integration of these resources was necessary to produce goods and services. Now, by what is called "demassification", we can achieve to the same functionality. Labor, materials and money can be combined while being throughout the world.

Scott (1996) believes that Human resource management in general and human resource professionals, in particular, should have unique conditions and characteristics to be able to lead the process of change in organizations. However, at present, human resource management is very slow in providing appropriate responses to environmental changes. The main problem is that human resource professionals have already done just tasks such as recruitment, compensation and so on. This might have affected in the time of stability of lack of change, but with the arrival of the digital economy, human resource professionals need to revive and strengthen partnerships with other factors in order to make the company change.

But how can human resource management consistent with the knowledge economy, and enhance the skills and capabilities of human resources?

Ulrich (1999) raises three key questions to address this question:

- 1) What is the work of human resource management?
- 2) Who will do work of human resource management?
- 3) How the technology will affect human resource management?

In response to the first question it must be said that the knowledge economy, human resource management work is not restricted to traditional tasks of recruitment, training and development,

performance management and so on. In the knowledge-based economy, human resource management functions include those activities that are involved in traditional business functions (such as marketing and finance) and also nontraditional activities (such as knowledge management). Therefore, human resource management does not focus only on "people management". Human resource management is now responsible for the management and development capabilities and abilities that people have created and for managing relationships that individuals should develop.

In answer to the second question it must be said that many human resource professionals are still engaged in traditional activities of human resources, although some of these things are now left to the agents out of the organization (such as staffing), and or are done in digital form (including electronic human resources). In addition, most traditional works of human resource management are now carried out by frontline managers and specialists in other areas (such as IT) or other parts of the organization. In the knowledge-based economy, by development of human resources management, the responsibility of human resources should be shared among human resources managers, employees and individuals outside of the organization.

And finally, "In answer to the third question, it should be noted that increasing and improving administrative efficiency, the technology allows human resource managers to use fewer personnel and play more valuable roles in the organization. The rapid development of e-service systems of human resources has caused to the fact that more information and in a more appropriate form be provided to employees and managers, in order to be used for human resources of the organization.

New systems of human resource management in the knowledge economy of the 21st century, by providing content based on the knowledge that is interpreted and explained on the basis of employee's role in the organization, has made the employees to perform their duties properly and develop their abilities and capabilities.

6. Concept and definition of intellectual capital

Stewart believes that intellectual property is a collection of knowledge, information, intellectual property, experience, competition, and organizational learning, which can be used in order to create wealth. In fact, intellectual capital includes the entire staff, organizational knowledge and the ability to create value, and the leads to consistently competition. "Bentis" defines intellectual capital as a set of intangible assets (resources, capabilities, competition) obtained from organizational performance and value creation.

Edvinsen and Malven define intellectual capital as "Knowledge and information applied to work to create value".

Bentis and Holland in their article in 2002 define intellectual capital as follows: intellectual capital indicates a reservoir of knowledge which exists in a specific part of an organization. In this definition the relation between intellectual capital and organizational learning is focused.

As a general definition, intellectual capital can be defined as: "Intellectual capital" indicates all intangible assets that are not physical and objective in nature, and determine the difference between market value and book value of their firms, they are Knowledge-based, are owned by their companies, are not regarded in the traditional balance sheet as an asset and can lead to value creation in organizations. All these features make the value obtained because of a purely local phenomenon and can not be bought and sold.

7. Goals of Intellectual Capital management

Measurement and management of intellectual capital is an effective tool for increasing competitiveness; understanding and managing these hidden assets have strategic role in the organization's global strategy. Intellectual capital index allows managers to have an understanding of the impact of intellectual capital on a real strategy. Goal of intellectual capital management is to encourage, innovate, self-motivate, initiative, utilize and build knowledge-based organizations. intellectual capital management has a pivotal role in the in remaining competitive in today's market which is rapidly changing and unpredictable. Objectives of intellectual capital management are:

Develop a comprehensive strategy for trading intellectual capital;

Development and implementation of intellectual capital for key projects;

Acquisition the value of the triple markets;

Intellectual Capital Management was established as an independent business.

8. Elements of intellectual capital

In general, scholars and practitioners of intellectual capital have consensus on three elements:

1. Human capital,
2. Structural capital,
3. Relational capital.

In this part we try to have more explanation about these elements.

a. Human capital

Human capital indicates the stock of knowledge in an organization. Ross and his colleagues also argue that employees create intellectual capital through their intellectual competence and agility. Bruking believes that human assets of an

organization, includes skills, assignment, problem solving skills and leadership styles. Stuart said that if in a learning organization, employees are regarded as the most important asset, however, they are not still in possession of the organization, since they are people who have emotions and feelings. They can only be committed and loyal to the organization.

b. Structural capital

Structural capital includes organizational charts, operating instructions, processes, strategies, implementation plans. Generally, all that is valuable to an organization more than its material worth. More clear, Ross and colleagues believe that what remains in the organization after the workers go home after work is the capital of the Company. Infrastructure assets, such as technology, processes and working methods, and also includes intellectual property such as know-how, brand names and patents. Moreover, according to Stuart, capital structure is knowledge in information technology, and patent, design and trade names. If an organization has poor systems and working procedures, intellectual capital will not reach its maximum potential. However, organizations with a strong capital structure will have a supportive culture that allows people to get new jobs, get failed, and learn. Moreover, Chen and colleagues argue that capital structure can help the staff in support unit to achieve optimal mental performance and also helps the business performance. Structural capital is also a function of the human capital. Thus, structural capital and human capital interact with each other to help organizations to collaboratively shape, develop and operate assets of customers.

c. Relational capital

Stuart explains the main topic of customer capital is knowledge in marketing channels and relationships between customers. Customer capital represents the potential of an organization for its external intangible factors. Moreover, Chen and colleagues classify capital in the form of customer marketing capabilities, strong market and customer loyalty. Fornell in result of his studies found that customers' consent can maintain a business relationship, reduce the flexibility of product cost and enhance a company's reputation. These studies provide further evidence of the importance of customer capital as a key component of an organization's intellectual capital. Development of

customer capital depends on support of human capital and structural capital. In general, customer capital, which acts as a bridge and through a process of intellectual capital, is the main determining factor in converting intellectual capital into the market value, and consequently, business performance of the organization. New definitions have developed the concept of customer capital to relational capital, which includes the knowledge in all relationships that the organization have with customers, competitors, suppliers, trade associations and government.

The goals of intellectual capital measurement

By reviewing more than 700 articles on intellectual capital measurement, Maar et al. (2003) indicated that five main goal is for measuring intellectual capital, that we will refer to them in the following:

To assist organizations in formulating their strategy;

To evaluate the implementation of strategies;

To help expand and diversify the company's decisions;

Non-financial evaluation of intellectual capital can be related to the repayment plans and rewards of managers.

To create a connection with the outside shareholders who have the intellectual capital. The first three goals of these series are related to the internal decisions, and their aim is maximizing the company's operating performance, in order to make earnings through the least cost, and continuous improvement in relations with customers and suppliers, and market share. The fourth is related to creating executive incentives. And the fifth one refers to making the motivation for stakeholders outside the organization. Many studies have shown that measuring intellectual capital is necessary and beneficial both for domestic and effective governance and for successful relationships with people outside the organization. It is clear that if the primary purpose of profit-making companies is effective management of future cash flows, then final stimulus for the management of the cash flows of the intangible assets is also essential for them. Since how can you manage something that you can not measure? Therefore, the measurement intellectual capital, and in general, intangible assets is very important.

9/6/2012

Effect of high-performance human resource management in the corporate entrepreneurship.

Ali Atashi* (Corresponding author), Hossein kharabi **

* Young researchers club, Astara Branch, Islamic Azad University, Astara, Iran

** Msc in management, Astara Branch, Islamic Azad University, Astara, Iran

The research is financed by Young researchers club, Astara Branch, Islamic Azad University, Astara, Iran

Abstract: This study sought to examine how performance aspects of human resources (selection, training, worker mobility, job security, job design, rewards, assessment of results and participation) communicate and impact on corporate entrepreneurship (risk-taking activities, pioneering, high innovation, and aggressive competition) with respect to the role of procedural justice and organizational citizenship behavior. This study shows that high performance of human resources has a positive relation with corporate entrepreneurship. Data analysis is done through collecting questionnaire from 93 managers of small and medium enterprises in Gilan using Pierson statistical test and multiple regressions. Research findings indicate that human resources are important for corporate Entrepreneurship prevalence and reach to a competitive power and maintain corporate development in a Long-term. In this regard, Procedural justice and organizational citizenship behavior is effective in corporate development in long-term and finally some practical solutions are listed for achieving the desired goal.

[Ali Atashi, Hossein kharabi. **Effect of high-performance human resource management in the corporate entrepreneurship.** *Life Sci J* 2012;9(4):1341-1353] (ISSN:1097-8135). <http://www.lifesciencesite.com>. 203

Keywords: corporate entrepreneurship, high performance of human resources, organizational citizenship behavior, Procedural justice

1. Introduction

Corporate knowledge and management has been changed fundamentally over the past 100 years. From the early 1980s, corporate showed much attention to innovation in order to accelerate changes. Nowadays corporate must have innovation to survive. So the best way is to encourage people to become an entrepreneur. It will become feasible through freedom and access to various resources to pursuit its goals better. In the era of global, regional, national business competitiveness, organizations environments is increasingly convulsive. The new field of scientific thinking announces that most successful organizations are those which take their important advantages from committed, versatile team players and all experts in all levels, not from absolute hierarchy. According to some researchers, corporate entrepreneurship is based on corporate ability for learning through new knowledge and exploiting current knowledge. These processes depend on Intellectual capital of the organization and especially on human and social capital. Increased competition in both local and global markets has revealed the significance role of entrepreneurship in the current corporate in order to develop competitive profit.

One organization with high performance is an organization which values for its employees and treat them as the most valuable asset of the organization. Such an organization has effective and efficient performance and knows itself responsible against Suppliers, sellers and commercial partners and tries to create more values for Shareholders, Treat them with

justice and respect to other shareholders and rules and environment. Organizations with high performance focus on costumer and continuous quality improvement and value human resources and variety and will become like a norm. Personnel factor and human resources increase the organization ability in achieving its goals. Some organizations have attracted efficient and devoted managers and employees and thereby could find global fame.

In future, technological corporations will depend on employees who are willing to contribute to the effective organizational performances regardless of their formal role. Therefore, the increased performance of employees like organizational citizens behavior is so important and even is so vital for these organizations. Human as an organizational citizen is expected to work more than his/her role requirements and beyond official duties to serve the goals of the organization. In other words, the structure of organizational citizenship behavior seeks to identify, manage and evaluate the behavior of the employees who work in organization and organizational effectiveness improves. Unlike past that employees were expected to act in formal roles, behaviors beyond role are expected in new psychological contracts. Current researches consider these behaviors as organizational citizens behavior and do not accept ignoring them in evaluating employees' performances and emphasis on a long-term partnership in the organization success. Perceiving injustice has devastating effect on the morale of collective work, because overwhelmed manpower efforts and employee motivation. Therefore justice is the key to the survival

and sustainability of staff development. Procedural justice has a positive correlation with corporate support, Interpersonal supports, innovation and pure competition for the organization.

Research findings which have been obtained in administrative central organizations of Iran in 1386 indicate that these organizations do not have a Favorable entrepreneurial state. The current state in these organizations has been traditional and non-entrepreneurial. According to these findings in Iran and the importance of entrepreneurship and human resources management and also their unfavorable trend in Iran, there should be more effort to accomplish these two important issues in Iran.

Therefore according to the current variable conditions staying in competitive markets and profitability besides addressing adequate skilled human resources organizational citizenship behavior and procedural justice in organizations has so many problems and is considered as a hard work. For promotion of corporate entrepreneurship to what extent are human resources important to reach a new competitive power and maintain organization development in long-term and does procedural justice and organizational citizenship behavior Influence on making organization development in long – term? The research findings can help managers in planning for high performance activities of human resource which can make and develop corporate entrepreneurship with procedural justice and Reinforcing organizational citizenship behavior.

2. Review of literature

1.2. Corporate entrepreneurship:

Corporate entrepreneurship is an important component in organizational performance. This component plays an important role in innovation development average and medium-sized companies' technologies. Entrepreneurship is increasingly a mechanism which not only supports the economy, but also makes Social, economical, benefits and a growth in the area. No doubt that contemporary organizations with this process of change and quick release of knowledge and information which caused the competition between companies and made it impossible to predict the future, confront Extensive international threats. Hence the survival of organizations needs solutions and ways of confronting problems and gaining knowledge and skill in every job which depend much on innovation, making goods, processes, and new approaches. Therefore the governments concluded that there is a need of entrepreneurship development for reaching an economic success in national and international levels, in the area of services and products in organizations. The research results in a Canadian university can be mentioned for the importance of entrepreneurship, it

asserted that decreasing the power of entrepreneurship causes decreasing 85 percent of growth in a long-term.

In fact, nowadays the role of the entrepreneur is an engine of economic development, champion of industrial development, investment encourager, The main option for technology transfer, option for fixing damage and market constraints, the main option for creating jobs. Entrepreneurship is a very important issue which many developed and developing countries pay so much attention to. One of the main branches of entrepreneurship, is entrepreneurship in organization has a significant contribution to the organization's success and excellence. Entrepreneurship is the dynamic process of generating incremental wealth. Those who make this wealth accept major and time financial risk and job commitment or make value for some services or products. Services or products may be new or Unique but the main point is the value that entrepreneur gives to it. Entrepreneur With proper understanding of skills and resources can make this value. Corporate entrepreneurship refers to perilous business by organization and Internal entrepreneurship which emphasizes within the organization as a place for entrepreneurial activities development. It is seen as a source of new and perilous business within the organization and it can be considered as challenge of organization for self-renewal in a broader realm through using new combinations of resources.

Corporate entrepreneurship is a set of activities which makes exploiting the competitive advantages of innovation possible in an organization and it is an approach in institutionalizing innovation. In fact corporate entrepreneurship is considered as a window to exploit the competitive advantages, innovation and leadership for organizations. Successful men and women have superior characters in business world. Yet entrepreneurs should have other positive characteristics besides honesty. A person who wants to put big business must coordinate his employees, and issue that needs justice. Also he should recognize the staff Annoyance and solve injustice. Nothing can harm organizations more than apparent injustice. If someone in the same position of other people, is favored over them, or receives more financial rewards, deep differences will be create between them. An Entrepreneur should be a just judge. Our country needs brave, creative, innovative and risky organizational entrepreneurs in the public and private sections for reducing and relieving from economic problems like Inflation and unemployment to make a new plan In line with the organization and community development.

According to Aktan and Biolet (2008) corporate entrepreneurship includes 4 aspects which are innovativeness, risk-taking, proactiveness, competitive aggressiveness.

2.1.1. Innovativeness: innovativeness means the most innovation which can be within product, services, or technology. Night (1997) considers development or Products Promotion and services and also principles and technologies as a part of corporate innovation.

2.1.2. Risk-taking: risk-taking includes corporate orientations in order to reach new innovations for profit and corporate development with the lowest possible losses.

2.1.3. proactiveness: this aspect is related to leadership in pursuing opportunities entering new markets. Leadership is an amount that organizations in issues like key areas of business, at the time of introducing products and services, using technology and administrative techniques try to lead competitors.

2.1.4. Competitive aggressiveness: it is defined as the organization's tendency in challenging or competing with competitors. In fact competitive aggressiveness is a response to threats.

History, concept and theoretical principles of entrepreneurship date back to the 18th century. In that time, Richard Kanilon divided economic factors to three categories of ground, work force, and risk-taking economic factors. The incorporation of risk-taking concept with economic activities was the first step for the codification of theoretical foundations of entrepreneurship. Therefore some people call him the innovator of the word "Entrepreneurship". Thence entrepreneurship concept has been changed so much and has gone beyond the economic area and has established a new paradigm with traversing the boundaries of creativity and innovation which cannot be explained except with the title of entrepreneurship. The history of entrepreneurship is in the table below (Table 1).

2.2. High performance of human resources

In today's highly competitive environment traditional sources of competitive advantage for organizations like technology, scores' rights, the economic advantages, have lost their efficiency with globalization and other environment changes. So retaining and attracting talented, skilled and flexible employees as alternative options for these sources can help to develop the core competencies of organizations. Therefore managers use functions of human resource management. Haslid and Baker 1996 believe that a human resource system which is designed and applied appropriately can be considered as an economic and valuable asset for an organization. In recent decade, academic studies argue that human resources which are unique resources for corporate potential make a continuous competition for organizations. Employees are the main source for organization and their value is in their rare, inimitable and non-replacement behaviors.

Table 1: evolvement of entrepreneurship

The emergence of theoretical concepts of entrepreneurship and the term entrepreneur
The root of this word is French, it means broker or dealer
Medieval: a player or a person who is responsible for big manufacturing projects
17 th century: a person who suffers Losses on fixed-price contract with the government
1725: Richard Kantilon : a person who takes the risk is different from a person who is the Provider of capital
1803: Jean Baptist C: entrepreneurship benefit is distinct from capital benefit
1876: Francis Valker: there is a difference between those who provide capital with those who Have the financial ability
1934: Jozef Shompiter: an Entrepreneur is innovator and the creator of new technologies.
1961: David Mc colland: Entrepreneur is an active person who takes the common risks
1964: Piter Draker : Entrepreneur maximizes opportunities
1975: Albert Shaprow: Entrepreneur is innovator and organizer of several social and economic mechanisms and takes the risk of bankruptcy risk.
1980: Karl Wesper: Entrepreneur is different From the perspective of economists, psychologists, merchants, and politicians
1983: Giford Pinchat: Inter –corporate Entrepreneur is an entrepreneur is a new established organization
1985: Robert Histrich: Entrepreneurship is the process of creating something valuable and different through devoting sufficient time and effort, with financial, psychological and social risk, also receiving financial rewards and Personal satisfaction from the results.
Mid-twentieth century: the theory of innovative Entrepreneur: The task of the entrepreneur is reforming and transforming production paradigm by exploiting the invention or more generally untried technological possibility for producing new products or producing old products in a new approach, opening new sources for accessing new material or new market of products with new industrial organization

Haslid 1995 suggested that the companies with better performance choose to invest on complex ways of human resources for achieving a high performance. Because these companies have found that human resources are the most important asset of a company and they can fertilize productive capacities and Inherent capabilities of people. The complexity and importance of human resources activities has been increased so that in the current time even smallest organizations have a full-time manager for human resources circle.

In fact Human resources system is an important mechanism which according to it an organization's information about its members is recognized and analyzed. Managers categorize and attract them according to employees' performance and behavior in different parts of an organization. Recently, different studies about certain types of systems or HRM structures applied in the organization performance have been discussed and analyzed. Examples of this information have been observed in works of Arthur (1992,1994), But (2002), Bikro Gerhardert(1996), Dilery and Dati (1996), Den Harteg and Verburg (2004), Gatteri (2001), Hasild (1995), Ichonsky and Shav (1999) and Mc Daffi (1995).

Some of the related systems are called HRM methods, High-involvement work systems (HPWs). A high performance system is able to identify a set of distinct but interrelated ways which as applied in order to choose, maintain and make motivation in a work force which has prominent features (i.e. specific key skills) and to use abilities in job activities and work-related activities (Outcomes, the actual behavior of employees). All these approaches are Intermediate indicators of company performance (i.e. indicators upon which work force is able to control directly.) and provide an appropriate context for sustainable competitive advantage. Such systems play an

important role in Increasing capabilities, commitment, and motivating employees and finally provide an appropriate context to improve organizational performance. Over several studies, the positive effect of HPWs on organizations performances is proved. High performance of human resources includes coherent proceedings which encourage organizational citizenship behavior, Staff and company skills in making decisions and cause encouraging employees, cooperation, exchanging knowledge and volunteering for work.

Using an approach Based on resources, Dilery Vedati 1996 have discussed that the human resources performance facilitates employees' works in the fields of education and job development. On the other hand from the control point of view Esnel 1992 has presented a theory that human resources performance depends so much on the employee performance showing. Both approaches do not provide the need of modern enterprises in the current competitive environment. So Bamberger and Mishalam 2000 incorporated these two approaches into a coherent framework and valued the high performance of human resources so much. Three parts of the high performance of human resources according to the model of Bamberger and Mishalam 2000 are shown in the picture below (Figure 1).

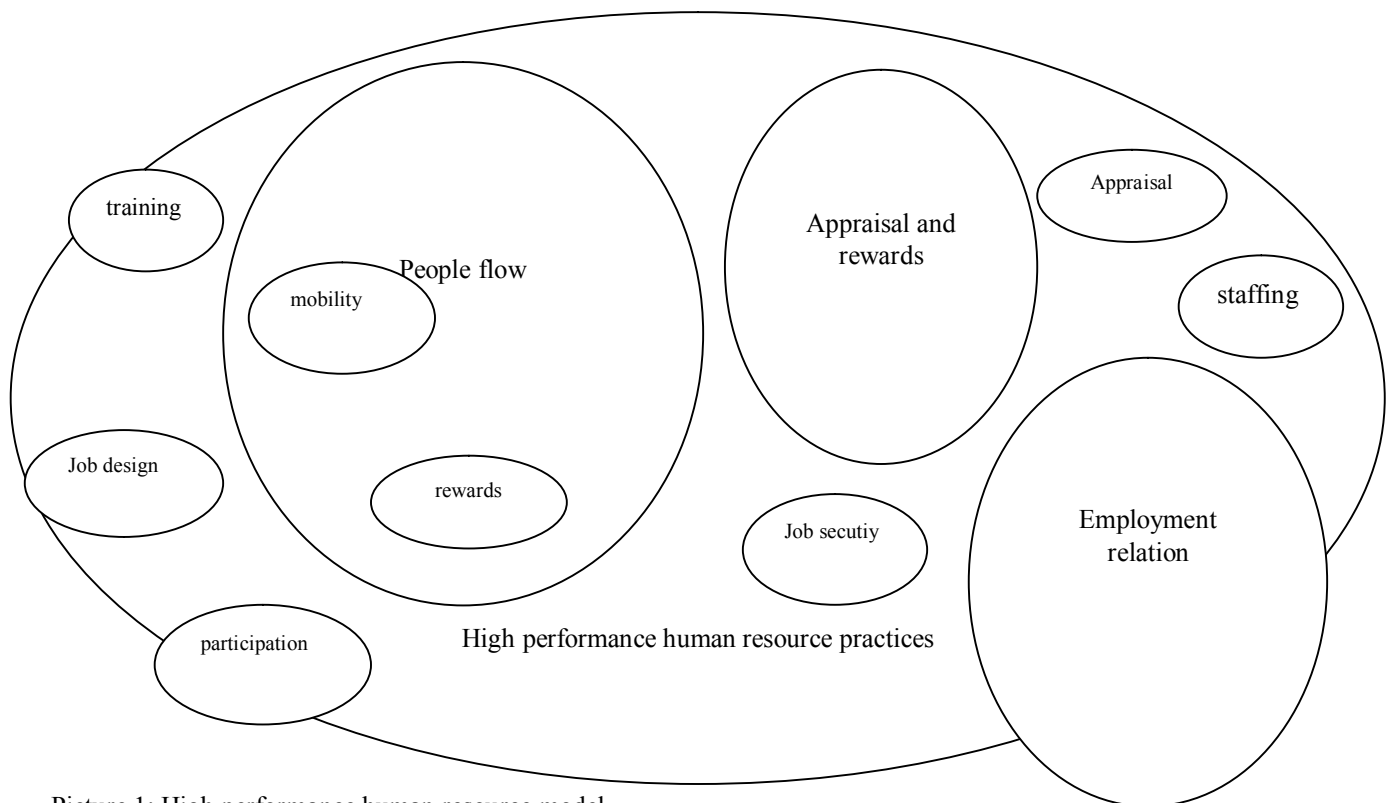

Picture 1: High performance human resource model

Based on the above model, the high performance of human resources includes three main parts of employment relations of human resources, work flows of human resources, and rewards of human selected staff, training, staff mobility, and job security. Assessments and rewards include performance evaluation, paying salary, and other benefits such as unlimited rewards. Work flows include job designing and encouraging in cooperation.

The novel philosophy of human resources management, its structure and organizing in a modern form, all are the results of events and developments which have started with the industrial revolution in England and have continued till today. From the developments of the industrial revolution 1760, the labor movement 1786, scientific management movement 1885, industrial Psychology 1890, this issue was gradually accepted that human resources management is a specialized task like production and Sales which should be left to the expert. Raising the school of human relations (Neoclassical) was a reaction against the classics. Alton Mayo is known as the father of this school. The goals of operating systems with high performance are effecting on company performance through increasing employees and team productivity and gaining a higher level of skill, competence, commitment and employees motivation, enhancing the quality of work, and services, increasing the quality level of services to the customer, increasing benefit, more develops, and making more value for shareholders with the help of staff. The characteristics of corporate high performance are: Attractive choice, promoting employment security, making and developing teams, providing development and more training, revealing essential information, creating supportive cultures, reducing different situations, giving rewards according to the performance, promoting health and security, completing the strategies of human resources management.

According to effect of human resources management's methods on the company performance and through analyzing the responses of 968 American companies to a questionnaire, Hasild 1995 found that if the companies use way of workings with high performance so much, then the loss rate and flow of employees will decrease strongly and productivity and profits of company will increase strongly.

3.2. Organizational citizenship behavior and procedural justice:

1.3.2. Organizational citizenship behavior: citizenship behavior is a kind of valuable and useful behavior which people blurt voluntarily. So this kind of behavior which is called organizational citizenship behavior looks so important.

According to organ 1990 organizational citizenship behavior means employee's talent for promotion from the role that is assigned. This behavior is except the role for supporting and facilitating psychological and social implications which supports task performance in the organization. Organizational citizenship behavior represents contents such as chivalry, civic virtue, Self-sacrifice, deontology, and politeness. Organizational citizenship behavior is meta-role behaviors and spontaneous behaviors that put employees in such a situation that work beyond Job expectations and their job descriptions voluntarily. Employee perceptions of the fairness of payments and equality in organizational procedures and fairness of interpersonal behavior have an important role in encouraging and developing organizational citizenship behavior. Nowadays voluntary, useful and over-expected efforts are known as organizational citizenship behaviors. Most managers want those employees who go beyond expectation, do behaviors which are not parts of their formal duties and generally have high organizational citizenship behaviors. The high performance of human resources causes incidence of long working relationship. Therefore employees have more time in organizational citizenship behaviors. If organizational citizenship behaviors degree is high in working texture, employees will have some innovations for the organization. On the other hand if organizational citizenship behaviors degree is low, then there will be no motivation and tendency for making creative Ideas in corporate entrepreneurship.

2.3.2. Procedural justice: one of the main ambitions of human in history was to establish justice in society. Then various schools of thought on human and divine were suggested for defining and establishing it. Procedural justice refers to the Perceived fairness of the procedures and processes by which outcomes are allocated. Therefore procedures are perceived when they are applied consistently and regardless of personal interests and based on detailed information, All of the participating interests be considered, Standards and ethical norms are observed.

In fact, today's organizations are miniatures of society and establishing justice in them is like establishing justice in society. For this reason, nowadays corporate justice such as other important variables in corporate behavior including corporate commitment and job satisfaction has found a special position in management literature. Studies show that procedural justice is related to cognitive, emotional and behavioral reactions of employees toward the organization (like corporate commitment). Therefore a process leads to a special outcome when it is understood unfairly. Understanding justice also depends on organization's following the rules of procedural justice. For example a procedure that allow

participants to express their subjects, is more equitable than a procedure that prevent this action. Procedural justice has two aims: firstly protects people interests, so they gain something they deserve. So procedural just is associated with results such as satisfaction, agreement, commitment. Secondly procedural justice reinforces the person's relationship with group, leaders' reliance and commitment to the organization. Fair procedures can be a sign for people so that they

feel valuable and respectful in the organization and it can promote balance and reliance in relation to others. It is important that group members believe organizational status is given to people Based on equality. Any idea that is made in inequality makes the organization unbalanced; in that case some corrective actions should be applied. Perceived procedural and interactional justice is the main anticipants of organizational citizenship behavior.

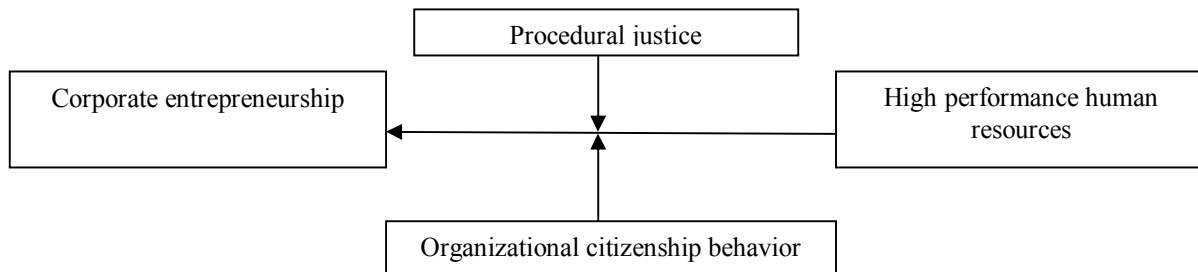

Figure 1: Conceptual Framework of the research and relations between variables

3. Corporate entrepreneurship and human resources systems

Many studies on direct relationship between human resources management and corporate entrepreneurship has been made in the last three decades. Corporate entrepreneurship is an important aspect of organization performance that HRM systems are expected to be effective like that. Since entrepreneurship capabilities need making networks with entrepreneurship capability or collaborative capability (both of them), using different sets of HRM approaches is recommended for promoting the special capabilities of entrepreneurship. So HRM system focuses on middle managers and entrepreneurship innovations in the organization. In fact managers are in the middle of these formal networks. Under these circumstances, entrepreneurship ideas are formed. So senior managers play an important role in the proceedings and successes of developing entrepreneurship innovation, from identifying opportunities to using them. Entrepreneurship is not a unique factor but consists of a few things. An entrepreneur organization have these features: pays attention to development, is more aggressive, has creativity, focuses its activities on the customer, can estimate the risks associated with each action, and then accepts the risks which probably cause the organization's development and the increase of market share, is tolerable against frustrations and failures, and finally has a lot of efficient employees, i.e. those who have long-term and short-term strategies and believe in the organization existence.

Haiton 2003 proved the positive effect of HRM on entrepreneurship performance in 99 American companies with more than 100-500 employees. He

gathered the information related to 25 HR approaches. He found out the positive and significant relation of HRM approaches on entrepreneurship performance. Yet traditional HRM approaches do not have such an effect. Companies with less than 100 employees do not show a tendency to use formal HRM approaches. According to Pfeffer 1998 human resources play an important role in controlling the organization and the central effective components on organizational performance. So to understand how to manage human resources with the goal of maximizing Productivity and enhancing creativity (Due to cost control) is the main task of researchers.

Working systems with high performance are organizations which are established base on Employees involvement and participation. In these systems, employees are known as the organization assets. So they do not look at the others as if they are without thinking. They allow employees to express their ideas for a better production and giving creative solutions for problems. So people feel they play an important role in the organization and are accepted as a main and key part of the organization. So they work with more motivation and their commitment will increase toward the organization, then they participate in the best way to improve organizational performance. Human resources approaches lead to the firm performance when they are incorporated to create and support the employees' abilities. So the best definition for strategy of entrepreneurship human resources is: a set or sets of human resources approaches that probably enhance converting new knowledge into new products or services. HRM approaches effect on making networks especially networks leading to three capabilities of entrepreneurship, i.e. recognition,

evaluation and using opportunities. In entrepreneurship companies, managers show a tendency to Informal contracts with employees and use strategic approaches to attract skillful employees (In order to sustain

business growth). Some of the researches about corporate entrepreneurship and human resources management which are used in this research are shown on the table below:

Table 2: the previous researches on corporate entrepreneurship and human resources systems

Author and research date	Research area	Research summary
Haiton 2005	corporate entrepreneurship, activities of human resources management	Activities of human resources management are related to corporate entrepreneurship, two issues of personal acceptance of risk and encouraging voluntary offset losses are related to each other.
Cook and Hartog 2006	Working systems with high performance, broad performance and innovation in small companies	KSAS is promoted by approaches such as training, job plan, and skills development. Since HPWS leads to enhancing KSAS of employees, helps them to influence on KSA and making motivation in them. The effect of prudent activities of employees, creativity and efficiency are issues that have attracted most experts' attentions.
Mason and Bart 2006	Knowledge and activities of human resources management, small companies	In most literatures, the positive relation between HRM and company's performance is proved. Researches show that training is one of the main subjects of HRM in most small companies. But formal training is not considered so much in these companies. The ability of a company in attracting, motivating, and maintaining employees through competitive salary and appropriate rewards, provides an appropriate in running the performance and company development.
Jack et.al 2006	Small entrepreneurial partnerships, human resources management	The importance of HRM in entrepreneurship is not only effective in helping to shape strategies, but also is effective in making partnerships and healthy development of organizations
Guy and Terembly 2007	High collaborative activities of human resources, procedural justice, corporate commitment, organizational citizenship behavior on specialized technologies of desertion.	Procedural justice, Sustained and effective commitment and modestly organizational citizenship behavior due high collaborative activities of human resources are effective on tendencies for desertion from high professional skills.
Oktan and Biolet 2008	corporate entrepreneurship	In corporate entrepreneurship, achieving greater economic potential needs more spending time and investment and should be reinforced constantly. In entrepreneurship, goals, strategies, processes, and values of the company are effective for the performance.
Zang et.al. 2008	High performance of human resources, corporate entrepreneurship, organizational citizenship behavior,	High performance of human resources has a positive effect on corporate entrepreneurship through enhancing organizational citizenship behavior
Behrens 2008	Working systems with High performance, employees' feelings, employment Status	Employees' feelings about corporate support, corporate commitment, corporate justice, with making decision and workload are related to job satisfaction and tendency to desertion. unsuccessful efforts for running working systems with high performance often lead to the low performance and satisfaction of employees and increased workload
Machitla 2008	Activities of human resources management, corporate performance, corporate entrepreneurship	HRM approaches has important effects on making networks especially those led to three entrepreneurial capabilities like recognition, evaluation and using opportunities.

4. Research hypotheses

4.1. Main hypothesis:

There is a significant relation between the high performances of human resources and corporate entrepreneurship according to the role of organizational citizenship behavior and procedural justice.

4.2. Subsidiary hypothesis:

1. There is a significant relation between human resources employment and corporate entrepreneurship according to the role of organizational citizenship behavior and procedural justice.

2. There is a significant relation between human resources training and corporate entrepreneurship according to the role of organizational citizenship behavior and procedural justice.

3. There is a significant relation between human resources job design and corporate entrepreneurship according to the role of organizational citizenship behavior and procedural justice.

4. There is a significant relation between human resources staff mobility (Variability) and corporate entrepreneurship according to the role of Organizational citizenship behavior and procedural justice.

5. There is a significant relation between human resources job security and corporate entrepreneurship according to the role of organizational citizenship behavior and procedural justice.

6. There is a significant relation between human resources results evaluation and corporate entrepreneurship according to the role of

organizational citizenship behavior and procedural justice.

7. There is a significant relation between human resources rewards and corporate entrepreneurship according to the role of organizational citizenship behavior and procedural justice.

8. There is a significant relation between human resources partnership and corporate entrepreneurship according to the role of organizational citizenship behavior and procedural justice.

5. Research methodology

Since this research studies the relation between the high performance of human resources and corporate entrepreneurship according to the role of two mediator variables in this relation. According to the goal, Application and method, data analysis is a correlation. Statistical population of this research is the managers of 600 small and average companies of Gilan province. The statistical sample of the research was obtained according to sampling formula from a limited society, managers of 93 small and average companies. In each company one of the managers was selected randomly and 110 questionnaire were given to managers and 93 questionnaire were analyzed, using SPSS software Pearson correlation analysis and Multiple regression were used for data analysis and test hypothesis.

6. Data analysis instrument: reliability and validity

6.1. Research instrument and its reliability

Questionnaire is used for gathering information in this research. Questions are designed so that the respondent mark the options according to Likert's five options range (seldom, few, average, much, too much) and a questionnaire which is used for gathering information is distributed to the respondents and constitutes questions related to dependent and independent variables.

Corporate entrepreneurship questionnaire constituted 17 questions that Oktan and Biolet 2002 provided that according to the aspects which are discussed by Baringer and Belardon 1999, Hornsby, Koratko and Zahara 2002, Miler 1983, Kalanton, Kavsgil and Zaho 2002, Antonik and Histrich 2001, Des, Lampkin and Kavin 1997, and Namen and Selvin 1993. A factor analysis was done for localizing this questionnaire in Iran and determining its validity. Two questions were deleted from 17 questions and the number of questions decreased to 15.

The high performance of human resources' questionnaire constitutes 28 questions which were provided by Snel and Din 1992 and other researchers like Bay and Lavler 2000, Dilery and Dati 1996, and Zang et.al. 2008 used it. For determining the questions reliability a Confirmatory factor analysis was applied

which all the questions of this variable were confirmed.

Procedural justice questionnaire constitutes 5 questions provided by Terembly, Guy and Simred 2001. For determining the questions reliability, a confirmatory factor analysis was applied that all the questions of this variable were confirmed.

Organizational citizenship behavior questionnaire constitutes 5 questions provided by Mayer and Alon 1991, Poodsakf and Ahern and Macenzy 1997, and Wiliam and Anderson 1991 and Par and Temeby 2007 used it. For determining the questions reliability, a confirmatory factor analysis was applied that all the questions of this variable were confirmed.

According to the contents mentioned above, the total number of questionnaire became 53.

6.2. Research instrument validity

Cronbach's alpha coefficient was calculated through SPSS software to determine the questionnaire validity. If Cronbach's alpha coefficient of the questionnaire is more than 70 per cent, it can be said that the questionnaire has acceptable validity. Cronbach's alpha coefficient for research variables are:

Cronbach's alpha of independent variable, i.e. the high performance of human resources is equal to 93/9 %, Cronbach's alpha of dependent variable, i.e. corporate entrepreneurship is equal to 74/6 %, Cronbach's alpha of first adjuster variable, i.e. organizational citizenship behavior is equal to 90/9 %, Cronbach's alpha of second adjuster variable, i.e. procedural justice is equal to 76/9 %, and Cronbach's alpha of all four variables is more than 70 per cent, it shows that questions validity is related to the variables.

Cronbach's alpha of high performance of human resources' components is as follows:

Cronbach's alpha of human resources employment is equal to 88/6 %, Cronbach's alpha of human resources training is equal to 86/4 %, Cronbach's alpha of human resources job design is equal to 81/5 %, Cronbach's alpha of human resources evaluation results is equal to 76/6 %, Cronbach's alpha of human resources rewards is equal to 71/1 %, Cronbach's alpha of human resources partnership is equal to 83/1 %. Cronbach's alpha of all variables is more than 70 per cent and it shows that questions validity is related to components.

7. The study of findings based on statistical test

Using statistical test, the relation between dependent and independent variables (main hypotheses) and also the relation between the high performance of human resources' components and corporate

Entrepreneurship (subsidiary hypotheses) is determined according to the role of procedural justice and organizational citizenship behavior of the

research. Statistical tables of hypotheses are as follows (Table 3):

Table 3: Descriptive table for high performance of human resources and corporate Entrepreneurship

Relation between variables (research hypotheses)	Significant level of relation before entering adjustor variables	Correlation intensity of variables before entering adjustor variables	Significant level of relation after entering adjustor variables	Correlation intensity of variables after entering adjustor variables
high performance of human resources and corporate Entrepreneurship	0.000	0.427	0.000	0.514
Employees employment and corporate Entrepreneurship	0.006	0.284	0.000	0.466
Employees training and corporate Entrepreneurship	0.136	No relation	0.000	0.463
Employees mobility and corporate Entrepreneurship	0.002	0.319	0.000	0.484
Employees job security and corporate Entrepreneurship	0.031	0.224	0.000	0.472
Employees design and corporate Entrepreneurship	0.000	0.409	0.000	0.508
Employees result evaluation and corporate Entrepreneurship	0.010	0.265	0.000	0.464
Employees rewards and corporate Entrepreneurship	0.271	No relation	0.000	0.466
Employees partnership and corporate Entrepreneurship	0.000	0.370	0.000	0.556

According to table 3 the result for statistical test of hypotheses is as follows:

The result of main hypothesis test: high performance of human resources has a relation with corporate entrepreneurship according to the role of procedural justice and organizational citizenship behavior.

The correlation intensity is 42/7 per cent between high performance of human resources and corporate entrepreneurship. Two adjustor variables of procedural justice and organizational citizenship behavior can be used for enhancing the intensity of this relation. Using these two adjustor variables simultaneously, the intensity of their relations will be enhanced to 51/4 per cent.

The result of the first subsidiary hypotheses test: there is a relation between employment and corporate entrepreneurship according to the role of procedural justice and organizational citizenship behavior.

Correlation intensity between employment and corporate entrepreneurship is 28/4 per cent. Two adjustor variables of procedural justice and organizational citizenship behavior can be used for enhancing the intensity of this relation. Using these two variables simultaneously, the intensity of their relations will be enhanced to 46/6 per cent.

The result of the second subsidiary hypotheses test: there is a relation between training and corporate entrepreneurship according to the role of procedural justice and organizational citizenship behavior.

Despite the lack of Initial correlation between training and entrepreneurship with entering adjustor

variables of procedural justice and citizenship behavior, a correlation is created between training and corporate entrepreneurship and the intensity of relation is 43/3 per cent between training and corporate Entrepreneurship.

The result of the sixth subsidiary hypotheses test: there is a relation between results evaluation and corporate entrepreneurship according to the role of procedural justice and organizational citizenship behavior. Correlation intensity between results evaluation and corporate entrepreneurship is 26/5 per cent. Two adjustor variables of procedural justice and organizational citizenship behavior can be used for enhancing the intensity of this relation. Using these two adjustor variables simultaneously, the intensity of their relations will be enhanced to 46/4 per cent.

The result of the seventh subsidiary hypotheses test: there is a relation between rewards and corporate entrepreneurship according to the role of procedural justice and organizational citizenship behavior. Despite the lack of Initial correlation between rewards and entrepreneurship with entering adjustor variables of procedural justice and citizenship behavior, a correlation is created between rewards and corporate entrepreneurship and the intensity of relation is 43/6 per cent between training and corporate entrepreneurship.

The result of the eighth subsidiary hypotheses test: there is a relation between partnership and corporate entrepreneurship according to the role of procedural justice and organizational citizenship behavior. Correlation intensity between partnership

and corporate entrepreneurship is 37 per cent. Two adjustor variables of procedural justice and organizational citizenship behavior can be used for enhancing the intensity of this relation. Using these two adjustor variables simultaneously, the intensity of their relations will be enhanced to 55/6 per cent.

8. Discussion

Human resources management plays an important role in developing entrepreneurial companies despite the recognition of HRM importance in developing entrepreneurial companies, research in this area is limited and a few studies are devoted to the recognition of HRM strategic nature in small companies. The proposed theories about establishing HRM intersection and small and entrepreneurial companies reveal the importance of understanding the role of HRM in these companies. Some resources asserted that because of reasons such as Value or credit, Scarcity, lack of sustainability, the inimitable derived from heterogeneity, ambiguity and complexity of the resources; provide an appropriate context in shaping stable competitive advantage. Generally when HRM activities are Stable, they reinforce people so that they will have an effect like associates on ambitious actions of employees. The results that researchers mentioned can be cited for showing the relation between corporate entrepreneurship and human resources. Hornsby, Koratko and Montago 1999 introduced five important factors which relate HR activities to CE. These factors include opportunity to use rewards, Provision of management support for innovation, access to resources for innovation, corporate structure that leads to training and cooperation and personal risk-taking. Shever and Shever 1995 have asserted: Creating an entrepreneurial corporate culture features need reinforcing organizational citizenship behavior in employees and managers so that they can help the organization in achieving challenging targets.

In this research, the relation between high performance of human resources and its eight components with corporate entrepreneurship was studied according to the role of two adjustor variables of procedural justice and organizational citizenship behavior. The results of statistical test of hypotheses indicate a positive and significant relation between the high performance of human resources and corporate entrepreneurship. In fact the main hypotheses of the research are confirmed. In the statistical test of research subsidiary hypotheses according to the statistical table 1, it is observed that six components (employment, employees mobility, job security, job design, results evaluation, and partnership) from eight components of high performance of human resources has a positive and significant relation with corporate entrepreneurship and there is no relation between two components of human resources training and rewards

with corporate entrepreneurship. According to the statistical population of current research, i.e. small and average companies of Gilan province, it can be said that the reason for the lack of correlation of two components training and rewards is the Little attention of managers to employees training and rewards and other researchers have confirmed it. For example researches indicate that training is one of the main subjects of HRM in most small companies but formal training is not considered so much in these companies. Despite the positive effect of training on performance, in small companies, this effect is no so high because of the high cost of education.

If management includes owners of an institution and encourages employees to a higher performance and does not pay attention to their payment, the organization's members will criticize, and will have low trust and fidelity. The traditional system on which a person is evaluated should be corrected, In order to assess the performance of the team. Evaluating a person's performance, determining hourly wage, personal motivations can force the team members to present a perfect performance. So in addition to the evaluating actions and giving rewards to employees (according to the role they played) management should evaluate the team's works, run profit sharing system, share people in the action, give some gifts to the team members, and work in such a way that people will be encouraged, and work more and do their best efforts towards the commitment of the team.

In the current research it is observed that a significant and positive relation is created between the high performance of human resources and corporate entrepreneurship by entering two adjustor variables of procedural justice and organizational citizenship behavior and correlation intensity increases significantly. Even if there is no correlation between a component like rewards or training from the high performance of human resources variable and entrepreneurship, there will be a correlation by entering the procedural justice and organizational citizenship behavior which indicates the positive importance and effectiveness of these two variables on high performance of human resources and corporate entrepreneurship.

According to the high importance of high performance of human resources and corporate entrepreneurship and discussed contents and previous research results it is determined that high performance of human resources promotes the qualitative relationship between employees and organization, thus an innovation will be created. So it can be concluded that those organizations which look at their human resources as the main assets of organization, give the employees this option to express their ideas for a better production and presenting creative solutions to solve

the problems. If the human resources in organization understand fairness and equality in managers' procedures, then they can do their tasks better and they will be motivated and relaxed. Managers should pay attention to the components of high performance of human resources in long-term for stable development of organizations through corporate entrepreneurship and make plan for them and invest on them and try to shape these components despite the procedural justice Fairness in employees and also the aspects of organizational citizenship behavior such as cooperation and generosity. So that by reinforcing these two variables in the relation of high performance of human resources and corporate Entrepreneurship, organizations can compete with their competitors without Bureaucratic formalities and in this changing era outpace other organizations and achieve a stable development.

Resources:

1. R David Fred. 1388. Strategic management. Translation of Ali Parsaian and Muhamad Erabi, 14th edition. Tehran. Daftare Pajooeshhaye Farhangi Publications.
2. Armstrong Michel. 1384. Strategic management of human resources. Translation by Seyed Muhamad Erabi and Davood Izadi Tehran. Daftare Pajooeshhaye Farhangi Publications. Second edition.
3. Agha zade Hashem. Reza zade Hossein. 1388. Corporate entrepreneurs.
4. Ebrahimi nejad mehdi. 1379. Strategic management in Commerce and Industry. First edition. Tehran. Samt Publications
5. Eslami Hasan. Sayar Abolghasem. 2007. Organizational citizenship behavior. Tadbir Magazine. 18th year. Number 187.
6. Imanipoor Narges. Zivdar Mahdi. 1387. The study of interface orientation to corporate Entrepreneurship and performance. Journal of Entrepreneurial Development. First year. Number 2
7. Bostanchi 1385. Job security with an approach to security and health and its role in keeping organization employees.
8. Taslimi Muhammad. Monavarian Abbas. Ashena Mostafa 1385. The study of relation between Social Capital and Internal Entrepreneurship. Management culture. 4th edition. Number 14.
9. Hasani Kakhki Ahmad. Gholi poor Arian. 1386. Organizational citizenship behavior. Another step toward improving organization performance against the customer. Pajooeshname Bazargani journal. Number 45
10. Hosseinzadeh Ali. Naseri Mohsen 1387. Corporate justice. Tadbir magazine. 18th year. Number 190
11. Haghshenas Asghar. Jamshidian Mehdi. Shaemi Ali. Shahin Arash. Yazdanshenas Mehdi 1386. The pattern of corporate Entrepreneurship in The Iranian government. Oloome Modiriate Iran journal. Second year. Number 8.
12. Rabinz Staphan P 1384. Corporate behavior. translation of Ali Parsaian and Seyed Mehdi Erabi. 11th edition. Tehran. Daftare Pajooeshhaye Farhangi publication.
13. Ramin Mehr Hamid. Hadizade Akram. Ahmadi Iman. 1388. The study of relation between understanding corporate justice and organizational citizenship behavior. Pajooeshname Modiriat tahavol. First year. Number 2.
14. Rahmani Mohamad Taghi. 1387. Names and addresses of active industrial workshops with 10 and more employees, 1385. Department of Planning of Gilan province. Bureau of Statistics of Rasht.
15. Rahimian Hamid. Goodarzi Farkhonde 1388. Working systems with high performance. Tadbir magazine. 20th year. Number 202.
16. Sarmad Zohreh. Bazargan Abbas. Hejazi Elaheh. 1380. Reserch methodology In the Behavioral Sciences. 5th edition. Tehran. Agah publications.
17. Saadat Esfandiar 1386. Human resources management. 13th edition. Tehran. Samt publications.
18. Seyed Javadin Seyed Reza. Farahi Muhamad mahdi. Taheri attar Ghazaleh. 1387. Understanding the influence of organizational justice aspects On various aspects of job and organizational satisfaction. Modiriat bazargani magazine. First Period. Number 1
19. Abdolmaleki Jamal, Yusefi afrashteh Majid, Pirmohamadi Mehrdad, Sabokroo Mahdi, Mohamadi Anushirvan, 1387. The study of relation between Entrepreneurial skills and corporate Entrepreneurship. Entrepreneurship Development journal, first year, number 2
20. Fadaee Keyvani Reza. Nasaj Hosseini Mohsen. 1387. Entrepreneurship. First edition. Rasht. Haghshenas publication.
21. French vendal. H bell Sil 1385. Development management in organization. Translation of Seyed Mehdi Elvani and Hasan Danayifard. Tehran. 9th publication. Safar-eshraghi publications.
22. Kart Right Rojer, 2002. Entrepreneurial organizations. Translation of Dr Ali Parsaian. First edition. Tehran. Termeh publications.
23. Cook james R. 1382. owards entrepreneurship. Translation of Mitra Teymoori. First edition. Amoozeh publications. Esfahan.
24. Moghimi Seyed Javad. 1385. The study of relation between organizational citizenship behavior and Entrepreneurial culture in organizations. Management culture, 4th year. Number 13.
25. Moghimi Seyed Muhamad. Ahmad Poor Dariani Mahmood. 1387. Entrepreneurship training in small and average businesses in iran. Needs and Solutions. Entrepreneurial development journal. First year. Number 1

26. Momeni Mostafa.1387. Corporate Entrepreneurship. Entrepreneurial organizations. Sanate khodro magazine. Number 117.
27. Najaf beygi Reza.1386. Organization and management.4th edition. (new edition). Tehran. Termeh publications.
28. Histrich Robert D. Piterz Michael P. 1385. Translation of Alireza Feyz bakhsh and Hamidreza Taghiyari. Fisrt volume. Tehran. Scientific publications of Sanati Sharif University.
29. Aktan, B., Bulut, C. (2008),"Financial Performance Impacts of Corporate Entrepreneurship in Emerging Markets: A case of Turkey", *European Journal of Economics, Finance and Administrative Sciences*, available at: www.eurojournalsn.com.
30. Antoncic. B & Hisrich. R.D. (2001), Intrepreneurship: Construct refinement and cross cultural validation, *Journal of Business Venturing* 16,pp 495-527.
31. Antoncic.Bastjan& Pordan.Igor (2008), Alliances, Corporate technological entrepreneurship and firm performance: Testing a model on manufacturing firms, www.elsevier.com/locate/technovation
32. Arocas.L R & Camps. J (2007),A model of high performance work practices and turnover intentions, www.emeraldinsight.com/0048-3486.htm
33. Artur. J.B. (1992), the link between business strategy and industrial systems in American steel minimills, *industrial and labour relation review* 45, pp 488-506.
34. Artur. J.B. (1994), Affect of human resource systems on manufacturing performance and turnover, *Academy of management journal* 37(3), pp 670-687.
35. Bae, J & Lawler, J. J. (2000), Organizational and HRM strategies in Korea: Impact on firm performance in an emerging economy, *Academy of Management Journal*, No. 43, pp 502-517.
36. Bajona.C, Locay.L (2008), Entrepreneurship and productivity: The slow growth of the planned economies, www.elsevier.com/locate/red
37. Bamberger.P & Meshoulam. I. (2000), *Human resource strategy*. Newbury Park, CA: Sage.
38. Barringer, B. R.& Bluedorn, A. C. (1999), The relationship between corporate entrepreneurship and strategic management, *Strategic Management Journal*, No. 20, pp 421-444.
39. Batt. R. (2002), managing customer service: Human resource practices, quit rates and sales growth, *Academy of management journal* 45(3), pp 587-597.
40. Becker. B & Gerhart. (1996), The impact of human resource management on organizational performance progress and prospects, *Academy of management journal* 39(4), pp 779-801.
41. Behrens.K (2008), Investigating the High Performance Work System: Employee Perception and Employment Conditions in a Health Care Setting,word *Academy of Science, Engineering and Technology* 43
42. Bienstock C.Carol, Demoranville. W. Carol,Smith K. Rachel (2003), Organizational Citizenship Behavior and Service Quality,*Journal of Services Marketing*, Vol 17, No 4, pp 357-378.
43. Calantone, R. J.; Cavusgil, S. T.; Zhao, Y. (2002), Learning orientation, Firm innovation capability, and firm performance, *Industrial Marketing Management*, Vol. 31, No. 6, pp 515-515.
44. Combs.James,Liu.Yongmei,Hall.Angel,Ketchen.Da vid(2006), How Much Do High-Performance Work Practices Matter? A Meta –Analysis of Their Effects on Organizational Performance, department of management, 59, pp501-528
45. De Kok, J.; Hartog, D. D. (2006),"High Performance Work Systems, Performance and innovativeness in small Firms", Available at www.eim.nl/smesandentrepreneurship.
46. Delery.J.E & Doty.H.D. (1996), Modes of theorizing in strategic human resources management: Test of universalistic, contingency and configurational performance predictions. *Academy of Management Journal*, 39, pp802-836.
47. Den Hartog. D.N & Verburg. R.M. (2004), High performance work systems, organizational culture and perceived organizational effectiveness, *Human Resource Management Journal* 14(1), pp 55-78.
48. Dess, G. G.; Lumpkin, G. T.; Covin, J. G. (1997), Entrepreneurial strategy making and firm performance: tests of contingency and configurationally models, *Strategic Management Journal*, Vol. 18, No. 9, pp 677-695.
49. Guthrie. J.p. (2001), High-involvement work practices, turnover, and productivity: Evidance from New Zealand, *Academy of management journal* 44, pp 180-190
50. Hayton, J. C. (2005),"Promoting corporate entrepreneurship through Human Resource Management Practices: A review of empirical research, *Human Resource Management Review*, No. 15, pp. 21-4
51. Hornsby, J. S.; kuratko, D. F.; Zahra, S. A. (2002), Middle managers perception of the internal environment for corporate entrepreneurship: assessing a measurement scale, *Journal of Business Venturing*, No. 17, pp 253-273.
52. Huselid, Mark.(1995),The impact of human resource practices on turnover, productivity,and corporate financial performance, *Academy of Management Journal*, Vol. 38, No. 3, pp. 635-672.
53. Huselid, M.A. & Becker, B.E. (1996), Methodological issues in cross-sectional and panel estimates of HR-firm link, *Industrial Relations*, Vol. 35, pp. 400-22.
54. Ichniowski. C & Shaw. K. (1999), The effects of human resource management systems on economic performance: An international comparsion of US and Japanese plants, *Management Science* 45, pp 704-721.

55. Kuratko.D.F, Hornsby.JS, Bishop.J W(2005), Managers Corporate Entrepreneurial Actions and Job Satisfaction, *International Entrepreneurship and Management Journal* 1, pp 271-291
56. Jack.s,Hyman.J,Osborne.Fr(2006), Small entrepreneurial ventures culture, change and the impact on HRM: A critical review, www.socscinet.com/bam/humres
57. Ichniowski. C & Shaw. K. (1999), The effects of human resource management systems on economic performance: An international comparison of US and Japanese plants, *Management Science* 45, pp 704-721.
58. Kuratko.D.F, Hornsby.JS, Bishop.J W(2005), Managers Corporate Entrepreneurial Actions and Job Satisfaction, *International Entrepreneurship and Management Journal* 1, pp 271-291
59. Jack.s,Hyman.J,Osborne.Fr(2006), Small entrepreneurial ventures culture, change and the impact on HRM: A critical review, www.socscinet.com/bam/humres
60. Lind. E A, Kanfer.R, Early.R (1990), Voice, Control and Procedural Justice: Instrumental and Non-Instrumental Concerns In Fairness Judgments, *Journal of Personality And Social Psychology*, pp 952-959
61. Lober.Douglas (1998), Pollution Prevention as Corporate Entrepreneurship, *Journal of Organizational Change Management*, Vol 1, No 1
62. Maccitella, U. (2008),"The Effect of Human resource Management Practices on organizational performance through corporate entrepreneurship", University Bacconi, Track Economic & Management.
63. MacDuffie. J.P. (1995), Human resource bundles and manufacturing performance: organizational logic and flexible production systems in the world auto industry, *Industrial and Labour Relations Review* 48, pp 197-221.
64. Mayer. R.C & Allen. N.J. (1991), A three component conceptualization of organizational commitment, *Human Resource Management Review* 1, pp 61-89.
65. Mayson, S & Barrett, R. (2006),"The science and practice of HRM in small firms", *Human Resource Management Review*, No. 16, pp. 447-455, www.socscinet.com/bam/humrs.
66. Miller, D. (1983), The correlates of entrepreneurship in three types of firms. *Management Science*, Vol. 29, No. 7, pp 770-791.
67. Naman, J. L.& Slevin, D. P. (1993), Entrepreneurship and the concept of fit: a model and empirical tests, *Strategic Management Journal*, No. 14, pp 137-154.
68. Organ. D.W, (1990), The motivational basis of organizational citizenship behavior. In B.M.Staw & L.L., Cummings (Eds), *Research in organizational behavior*, pp 43-72.
69. Pare, G & Tremblay, M. (2007),"The influence of High- Involvement Human Resource Practices, procedural justice, organizational commitment and Citizenship Behaviors on Information Technology professional's Turnover Intentions", pp326-358, available at: <http://gom.sagepub.com> hosted at <http://online.sagepub.com>.
70. Padsakoff, P.; Ahearne, M.; Mackenzie, S. (1997), Organizational citizenship behaviors and sale unit effectiveness, *Journal of Applied Psychology*, No. 82, pp 262-270.
71. Snell.S.A, (1992), Control theory in strategic Human Resource management: The mediating effect of administrative information. *Academy of Management Journal* 35, pp 292-327.
72. Snell, S. A.& Dean, J. W. (1992), Integrated manufacturing and human resource management: A human capital perspective, *Academy of Management Journal* 35, pp 467-504.
73. Tremblay, M.; Guay, P.; Simard, G. (2001), organizational commitment and OCB: the role of HR practices, Paris: L. Cadin.
74. Williams. L.J & Anderson. S.E. (1991), Job satisfaction and organizational commitment as predictors of organizational citizenship and in-role behaviors, *Journal of Management* 17, pp 601-617.
75. Zhang, Z.; Wan, D.; Jia, M. (2008), Do High-Performance Human Resource Practices help corporate entrepreneurship? The mediating of organizational citizenship behavior, *Journal of High Technology Management Research*, No. 19, pp. 128-138.

9/6/2012

Hiccups due to hepatitis on the base of Iranian Traditional medicine

M minae¹, Q Mohammadi^{2*}, M somi³, M Mosadegh⁴, M Kamalinejad⁵, A Nikbakht Nasirabadi⁶

¹Research Institute for Islamic and Complementary Medicine, Tehran University of Medical Sciences.

²School of Iranian Traditional Medicine Shahid Beheshti University of Medical Sciences.

³Tabriz Liver and Gastrointestinal disease research center.

⁴Department of Pharmacognosy, School of Pharmacy, Shahid Beheshti University of Medical Sciences.

⁵Department of Pharmacognosy, School of Pharmacy, Shahid Beheshti University of Medical Sciences.

⁶Faculty of Nursing and Midwifery, Tehran University of Medical Sciences.

ABSTRACT: Hiccups are involuntary severe spasmodic inspiration of diaphragm and inter-coastal muscles. However; from the point view of traditional medicine in Iran, it is defined as the upward movement of stomach material and consists of counteraction and expansion movements. It is a movement which exiles the wind from the stomach. Hiccups, if held continuously and be chronically, can lead to loss of job and the person suffering from it may face mental problems as well as depression in society. There are very few studies regarding hiccup etiology recorded in medicine; however, to cure the usual and short-lasting hiccups, some ways as metoclopramide, chlompromasins, Baclofen Gabapantin can be used. The cure usually lasts long and is not usually effective and is accompanied with chemical drug side effects. There are very comprehensive and various discussions regarding kinds, diagnosis, and treatment of hiccups in traditional medicine. However, the discussions have not been studied extensively. In the present study, Avicenna's view and some other ancient scientists' views are under focus and it concentrates on hiccups derived from the interaction of huge liver inflammation and its treatments. The kinds of hiccups were also discussed.

[M minae, Q Mohammadi, M somi, M Mosadegh, M Kamalinejad, A Nikbakht Nasirabadi. **Hiccups due to hepatitis on the base of Iranian Traditional medicine.** *Life Sci J* 2012;9(4):1354-1356] (ISSN:1097-8135). <http://www.lifesciencesite.com>. 204

Keywords: Hiccups, Hepatitis, Avicenna, Iranian Traditional Medicine.

INTRODUCTION

Hiccups, which are experienced by infants, children, and adults, are a kind of strong and involuntary breath accompanied with counteractive and expanding movements [9].

Its mechanism is not well recognized in medicine and its path physiology is not known. Transient hiccups usually occur after stomach distension and consumption of alcohol and they are usually cured spontaneously or by the use of local and simple procedures [2,7,8]. In Iranian traditional medicine, hiccups are considered as stomach ailments, and are kinds of winds coming out of stomach with counteraction and expansion movement of stomach [1,2, 3]. If transient, hiccups are not taken serious and don't call for any treatment, yet if they last long and are chronically, they will be bothering and need immediate treatment [6].

Long-lasting hiccups are very rare; however, they can lead to job loss, depression, pneumonia, weight loss, and sleep disorder [7, 8] and are closely related with breath loss, inability to eat, aspiration pneumonia. Chronically hiccups can have various sources in medicine and may derive from neurologic and non-neurologic factors and can be observed in diseases such as brain tumour, prostates cancer

abdomen surgeries, Mioclonose, MI, Peptic Ulcer, Gastritis, Deodonitis, oesophageal reflex, and encephalitis. They are mostly treated with metoclopramid, Chlorpromazine, Balclofen, and Gabapanten [7, 8]. We can prevent depression and human mental problems by finding ways to treat and understand the cause of hiccups. Although there can be found a lot of information concerning hiccups in traditional medicine, few proofs can be observed regarding its analysis and application. Also, the suggested treatments have not been evaluated. In the present study, Avicenna's and some other ancient scientists' views have been taken and the cures as well as kinds of hiccups are given with their treatment.

METHODOLOGY

This is a descriptive study and was performed in a 6-month period in the library of Shahid Beheshti traditional medicine faculty of Tehran in 2012. Avicenna's "canon" has been the focus of attention and other books like Exir-e-Azam, kholasat-ol-hekmah of Aqili were also used to understand and explain even more. So, the related information were searched, extracted, and notes were taken. Then, the essential data were classified consulting related professors. In the end, kinds of hiccups and their

treatments were discussed and analyzed. Hiccups in traditional medicine: Avicenna considers hiccups as stomach deceases and defines it as various combined movements of *Tashannoje*¹ counteraction and *Tamadode*² expansion in stomach cardia. It is a defensive movement such as a cough [1]. There are 3 main causes for hiccups, namely, A) suffering of stomach cardia B) stomach cardia C) interaction of other organs.

A) There are five kinds of hiccups deriving from stomach cardia suffering

- 1) Coldness of stomach cardia:
Hiccups can be caused from everything that cools down stomach cardia such as cold air, cold humor, cold drugs and foods and icy water [11]. This kind of hiccups can be found in infants, old people and passengers in cold air as well as chronicle diseases.
- 2) From stomach heat: in high fevers and eating hot foods.
- 3) Stomach cardia: eating spicy foods like pepper, old wine or eating very sour things, and pouring infective humor such as corrupted food which burn after they are corrupt. Also, a pouring bile into the stomach cardia.
- 4) Tamaddod caused by confinement of wind in the stomach cardia which leads to *Tamadod*: This is also high infants special after being fed with milk.
- 5) Stomach cardia heaviness: It might be due to overeating or eating heavy food and pouring *Lazej* phlegm [2].

B) Hiccups derived from stomach cardia dryness

This is of two kinds:

- 1) Spasm severe dryness (*Tashannoji*) which is found at the end of severe fevers, extreme vomits, and long experience of hunger [11].
- 2) Transient dryness which is removed by a little wetness.

C) Hiccups caused by the interaction of other organs

This is of two kinds:

- 1) From the interaction of a single organ like a huge liver inflammation, gastritis, and encephalitis.
- 2) From the interaction of the whole body such as fevers which lead to headaches. Also, in the illness crisis.

Hiccups and prognosis

Hippocrates puts the view that hiccups can sometimes be a symptom of some diseases [4].

If hiccups are accompanied with red eyes, this is seen as bad prognosis and can be a sign of brain

inflammation, or gastritis, or the inflammation of vagues nerve [1, 2].

Also, hiccups can be poor prognosis in hepatitis, after sever vomiting, especially hematemesis, heavy breathing, acute disease, and diarrhea.

It is fatal; in *Zahir*. Hippocrates also believes if hiccups follow massive hemorrhage, it can be a prognosis of bad news [2, 5].

Lazej: A sticky wet material.

Tashannoj: A Contractible Movement from Extreme to Center in Muscle, Tendon, Nerve.

Tamadod: an extension Movement from center to both extreme in Muscle, Tendon, Nerve.

Zahir: A kind of diarrhea same of chicken fecal.

The causes of hiccups caused by interaction of liver

A feeling of pain and heaviness in RUQ is an important sign of liver inflammation and if they come with hiccups, it can be symptom of a huge liver inflammation [1, 2, 8]. This inflammation can be in superior or inferior part of the liver and is due to the pressure on stomach cardia. This is of 3 types:

- 1) Blocking of inferior side of liver.
- 2) Huge inflammation of inferior or superior side of liver.
- 3) Mesenteric vein blocking

Diagnosis of hiccups caused by liver inflammation are based on the following signs and symptoms [1]

- 1) Fever
- 2) Heaviness of RUQ
- 3) Burning of RUQ
- 4) Sub-coastal inflammation
- 5) Dry coughs
- 6) Thirst
- 7) Painful RUQ
- 8) Loss of appetite
- 9) Redness of face and tongue
- 10) Hiccups

Hiccup treatment

In Iranian traditional medicine, there are many various treatments for hiccups which we refer to some as following. Vomiting can sometimes treat a slight hiccup. One of the essential treatments of hiccups is *Castrum* (*jond-e-bidastar*) which is dissolved in water, water rose, or vinegar and taken by patients. This drug can treat sever and chronic hiccup, [6]. Of other drugs, chicory, seed, and root of chicory continually used in liver ailments can be used for treating hiccups caused by hepatitis [1]. In resources of traditional medicine, chicory and its root can open up the blockage of liver.

CONCLUSION

Hiccups are stomach deceases and are defined as movements of stomach material in stomach cardia. The movement of stomach is to remove material. However, it is a respiratory disease in medicine. To cure this in medicine metoclopramide are used.

These are mostly to prevent hiccups, yet in Iranian traditional medicine, treatment is done by removing the real cause.

In common hiccups Castrum (jond-e-bidastar), Eyaraj-e-Figra, Artemisia Absinthium, Indian Salt, Oxymel Urginea Maritina (sekanjabin-e-onsoli), Trigonella Foenum Graecum, combination of Costus Costus, crocus Sativa, Roses, are used.

Also, holding breath, copping stomach, copping between shoulders, and long sleep is also recommended to treat hiccups.

However, different kinds of hiccups caused by different factors require various treatments. In hiccups caused by liver inflammation, the inflammation needs to be treated first. Hiccups accompanied with heaviness and pain in RUQ can be sign of hiccups in interaction with liver inflammation.

This study states that hiccups can be sign of some diseases and prognosis of them. With the careful study of its kind, one can treat and remove the very cause of them.

It seems that hiccups caused by interaction of other organs have been ignored and the decease has become chronic due to not being diagnosed.

Future studies on this field can shed light on fast and exact treatment of hiccups with knowledge of various kinds.

Corresponding Author:

Qadir Mohammadi, MD, PhD Student of Iranian Traditional Medicine, School of Iranian Traditional Medicine, Shahid Beheshti University of Medical Sciences, Tehran, Iran. Tel: +98-2188773521
e-mail: info@phyto doctor.com

Acknowledgement:

Authors are grateful to **Sanaz Salemayegh** (Azerbaijan Industry and Agriculture Development and Studies co.) for assistance in preparation of the article.

REFERENCES

1. Avicenna, al-Din.IS, editor, Conon fi al-Tibb. Lebanon: Alamy Le- Al-Matbooat institute, 2005; p.157.
2. Nazem Jahan Mohammad AK, Eksir-e- Azam.2ed, Tehran university of MedicalScience: Institute for Islamic and Complementary Medicine, 2007; p.543-544, p.33.
3. Al-ozdi Abu Mohammad,Almae, Tehran university of MedicalScience: Institute for Islamic and Complementary Medicine, 2007; p.1021.
4. Hippocrates,harhe Fosol Bograt, Tehran university of MedicalScience: Institute for Islamic and Complementary Medicine, 2007;p.219.
5. Avicenna, Canon, Tehran university of Medical Science: Institute for Islamic and Complementary Medicine, 2007;p.177.
6. Aqili Khorasani,Kholasat-ol-Hekmat Nazem esmaeel. Tehran university of Medical Science: Institute for Islamic and Complementary Medicine, 2007; p.1015, 1167,1474,1466.
7. Arzani Mohammad,Tib-e-Akbari, second Vol, Iran Medical University,p.709.
8. Launois S, Bizec JL, Withelaw WA, Cabane J, Derenne JP, hiccup in adults: an overview,Eur Respire J, 1993 Apr;6(4):563-75.
9. Moreti R,Torre P;Gabapentin as a drug therapy of intractable hiccup because of vascular lesion, department of physiology and pathology, Universitia degli studi Trieste, Italy.
10. PDR for herbal medicines.second edition, medical economics company, Montvale,new jersey.
11. M Emtiazy, M Keshavarz, M Khodadoost, M Kamalinejad, SA Gooshahgi, Relation between Body Humors and Hypercholesterolemia, Iranian Red Crescent Medical Journal, Vol 14 March 2012; p.133-137.
12. San San Tay, Ragesh R Yadav, Novel Use of Baclofen in Cancer Patients for the Treatment of Hiccups, Division of Rehabilitation medicine, Changi General Hospital, Singapore, Department of Palliative Care and Rehabilitation Medicine, MD Anderson Cancer Center, USA.

10/10/2012

A local leadership model for adaptive studying leadership style of government and non-government newspapers

Farhangi Ali Akbar¹, Mirsepasi Naser², Memarzadeh Tehrani Gholamreza³, Samadi Mehran⁴

¹ Professor in Islamic Azad University, Science and Research Branch, Tehran

² Professor in Islamic Azad University, Science and Research Branch, Tehran

³ Professor Assistant in Islamic Azad University, Science and Research Branch, Tehran

⁴ PhD student of media management in Islamic Azad University, Science and Research Branch, Tehran

Abstract: This study first intend to identify a pattern of local leadership for government and non-government newspapers, and secondly, to compare the pattern of leadership in the government and non-government newspapers. For this purpose, first, all leadership models have studied and 134 parameters as parameters of local leadership model have received combining them with Islamic leadership model that is appropriate to the circumstances of Islamic republic of Iran. These indicators provided for 56 professors of media management and newspaper managers. After factor analysis, 68 statements were classified in four classes that the charismatic leader with 32 statements, learning factor with 18 statements, values - ethnics factor with 12 statements and communications skills (empathy) with 6 statements were obtained. After implementing a questionnaire in pilot environment and calculating Cronbach's alpha, six statements were removed. And finally the charismatic leadership factor with 32 statements, learning factor with 16 statements, values - ethnics factor with 9 statements and communications skills (empathy) with 5 statements were obtained.

[Farhangi Ali Akbar, Mirsepasi Naser, Memarzadeh Tehrani Gholamreza, Samadi Mehran. **A local leadership model for adaptive studying leadership style of government and non-government newspapers.** *Life Sci J* 2012;9(4):1357-1364] (ISSN:1097-8135). <http://www.lifesciencesite.com>. 205

Key words: non-government newspapers, government newspapers

1. Introduction

1. Introduction In

The last phase of the research aimed to identify possible differences in the pattern of governmental and non-governmental leadership, the questionnaire distributed among employees of four papers were collected. The results of the analysis of the data shows that in all four dimensions Charisma, learning, values - ethics and empathy, there is significant differences between the patterns of leadership in government and non-government newspapers. The success of an organization in meeting its social objectives and responsibilities largely depends on its managers. If managers can perform their duties in an excellent manner, the organization reaches its goals. The goal of managers is to add value and achieve efficiency. For this purpose, managers do duties such as planning, organizing, staffing, leading and controlling (Iranzadeh and others, 2007, 56). The competent manager and professionals are expected that using the principles of management, deployment best methods, and good human relations and the appropriate management style can create a creative and productive organization in order to achieve organization goals and prepare an environment free from anxiety (Haghani et al, 2010, 164).

2. Problem statement:

Today, most organizations require rapidly changing to maintain their competitive position. To

achieve this, organizations should have leaders and staff that are adaptable and work effectively, improve systems and processes continuously and are customer oriented. Considering in different organizations can find out that great leaders do make a big difference. Effective leaders are those that find out results in a certain time framework to be effective for the industry and their business. Today, attention devoted to the planning and process is not enough people develop programs and manage and implement processes. As a result, it is expected that future leaders pay attention to developing individuals in the organization more. Therefore, organizations need to have leaders who evolve organizations by the phenomenon with greater ability in order to survive and grow. These leaders are responsible, use their imagination and try to make their imagination come true, make followers motivated to be commitment and voluntary participation and give them energy and finally conduct organizations toward learning organizations that can identify environmental needs and provide tools for their coordination with it. Such leaders are called transformative leaders. Transformative leaders pervade in beliefs, values and goals of followers and have great influence on their followers. The followers of these leaders feel trust and loyalty (soltani, 1991, 18-19).

Also, from point of view of Islam, leaders and their leadership style is important. Management and

leadership are part of a mission (mission is generally confined to the prophets) and the leader should accept sense of public commitment of the fate of man and society, focus on the evolution of greatest human traits, being far away self-centered and comprehensive following prophets as a principle. Otherwise, leadership and management will be instrument in economic and political power men and serves to increase their wealth and power. In Islam, the leadership and management is an obligation, a duty, a trustee and a huge responsibility on the shoulder of a divinely appointed and qualified and they have a heavy responsibility for it. Muslim leaders find themselves as same as their subordinates and their subordinates as same as themselves that are not different in term of human dignity and they are responsible for their leadership as a trustee and divine duty and they should consider this as a hard divine test. Leadership role (from Islam point of view) is to bring prosperity and actualize talent in divine way. Media management and specially newspaper management are no exception. However the media, despite many similarities with other educational institutions, has features that make it different from the other. Economically, the media should be able to provide financial and reinsurance. In term of human and institutional, media institution utilizing expert and efficient human resources in content production and processing needs to consider their educational, financial and psychological need and by coordination and continuity of human resources, nurture and encourage each employee to achieve maximum performance and personal development. Another interesting point is that, in addition to the common features among the media institutions, each media such as radio, TV and press has special features that these features according to specific requirements require norms and principles of management (Badiee, 2007, 6-7).

However, many management experts discussed about compatibility of west management with national culture in the developing countries. Some basic questions that can be investigated in relation to this subject is that despite an effort in the West to apply management models, why performance of organizations in these countries in comparison to developed countries is highly undesirable? Despite management courses in different levels of universities and institutes and development in most developing countries, why many managers do not have the necessary power to run and manage their organizations effectively? Why the knowledge and skills that managers learned in developing countries and is based on based on the ideas and experiences of western management, cannot make necessary

functionality to allow managers to increase the effectiveness of their organization?

Does today's management system which originates in the theory of the West and is deeply influenced by the social context, is fully transferable to other countries? Is that comprehensive so that despite political, economic, social and cultural differences in countries can have the same function in all societies? (Labaf, 2004, 115)

With regard to the results of research that has been done during last 30 years, it is clear that the main challenge faced by the Iranian media is media management. So, this study is intended by providing a model of leadership specific for local government and non-government newspapers, takes a step toward solving this problem. Therefore, since transformative leaders that have Islamic ethnics and are effective, are consider a strategic advantage for any organization and due to unique cultural and religious conditions in the country and since Islamic management is a school mission and school mission is to provide solutions that are consistent with the concept of justice (Afjei, 1999,10), The main question of this research is that:

What is appropriate and load leadership model for newspapers in Iran? And how leadership style of government and non-government newspaper differ from each other?

3. The necessity and importance of research

The most important asset of any organization is its human capital, or intangible assets. Human resource leadership as the richest source of organizational requires effective leadership style. Manager should recognizing and diagnosing a variety of individual, environmental and organizational factors that among the factors are employee motivations and their career aspirations; uses an effective leadership style. Finally, the move would guarantee the effectiveness of the management and success of the organization in achieving its goals (Iranzadeh, 2007, 65).

The concept of leadership and the need to design and use of local patterns is as important as leader Khamenei has often referred to this category:

"I have repeatedly emphasized that we should take country spirit and content of Islam, not alienated school, Cultures were asked to speak and think the way they become popular in the world; they would have preferred it to other countries and peoples of other nations to accept the same. We should not give in others counsel about ourselves; we should follow what is good and our need and what is right according to our faith and that is, Islamic law and Islamic mortgage and Islamic way; what we have defined Islamic regime according to it and called religious democracy ". (Islamic revolution eader

remarks in a meeting with officials of the Islamic Republic of Iran – 2002/08/20)

According to what is mentioned and due to most studies done in our country in field of newspaper management is more related to media economic and media ownership, this study firstly can help newspapers managers selecting appropriate local leadership patterns according to cultural and local conditions communicate more effectively and increase employee effectiveness. Secondly, given that this study focuses on national and religious culture, is considered as a complement to the field of leadership studies.

3. Research objectives

Ideal: Effective leadership in the media (emphasizing on leadership in the newspapers)

Main: Design a local leadership model for newspapers

Specific objectives

- 1- Identify leadership patterns between government and non-government newspapers in term of charisma
- 2- Identify leadership patterns between government and non-government newspapers in term of learning
- 3- Identify leadership patterns between government and non-government newspapers in term of value-ethics
- 4- Identify leadership patterns between government and non-government newspapers in term of communication skills

3.1. Leadership

Leadership and its impact on organizational effectiveness have a long history and have been reviewed and discussed by experts in this field; so that the leading experts have been selected different ways to recognize the relationship between leadership and organizational effectiveness and have proposed several theories based on it. Discussions started by personality theories. These studies discussed about the traits of great leaders that leader was described by internal characteristics who was born with them. These studies shown that personality traits may increase the possibility of successful leaders but no one can guarantee their success, behavioral theories focus on this issue was that effective leaders show what behaviors and in contingency theories, recognizing conditions and acting according to that, was the key of leaders success.

In recent years and in informed return about judgments related to the personality theories of leadership and in new format under titles such as documents and theories of leadership, leadership theory of charisma, servant leadership, excellence

leadership and transformational leadership theory, specific stimulus is performed. Characteristics of recent theories are that they are looking to include factors that are internal to motivate people to do so effectively. (Mortazavi et al, 1384, 169)

3.2. Leadership style

The way that leader use his power to achieve goals is called leadership style (Rezaeian, 2004, 18). Leadership style means knowledge and ability to perform certain tasks requiring skill in techniques and special tools for practical competence in behavior and activity. (Saatchi et al, 2010, 347)

Leadership style is the way leaders influence on their followers through it and is continued behavioral pattern of manager that he/she shows when conducting organization and employees activities (Moshabaki and Doostar, 2006, 220)

If the manager wants to be successful, his success is through the use of best management style that help mental health of the employees and make them independent on work environment and motivate all of them to work (Haghani et al, 2010, 165)

Some of the leading models for local leadership model used in this study include: transformative leadership, servant leadership, spiritual leadership, charismatic leadership, participative leadership, emotional leader, powerful leadership, fatherly leadership, capability leadership and Islamic management.

3.3. Islamic management

In Islam, leadership and management is a duty, an obligation, a trustee and a huge responsibility that chosen and qualified people are in charge of it and they have a big responsibility. In Islam, managers and leaders find themselves as same as their subordinates and their subordinates as same as themselves that are not different in term of human dignity and they are responsible for their leadership as a trustee and divine duty and they should consider this as a hard divine test. Leadership role is to bring prosperity and actualize talent in divine way. Islamic management means managing Islamic affairs in an Islamic way. In other words, in Islamic management, not only affairs should be Islamic and be true in term of Islam, but they should be done Islamic, i.e. should done through Islamic ways (Baher, 1991, 16).

Islamic management is such management that both in term of epistemological foundations and ontological foundations and both the method and goal is based on the principles of holy religion and morality. Therefore, in Islamic management not only manager should have Islamic piety but also his management should be based on Islamic values (Baher, 1991, 16)

Research Background

Looking at the history of the debates among the studies has done show that most of the arguments in this regard have the economic approach. In other words, the study of economics in the media is highlighted more than other dimensions of organization management. Picard studied government interference in the media market and investigated issue of how government can enhance social objectives conducting media market through regulation and subsidies and special favors (Rashkiyani, 2006, 50). In other research, Alexander studied on media industry and economic principles applied by them and provide an analysis of global integration of these industries.

Also, Gershon studied on the growth and increase of companies and media organizations emphasizing on environmental exploring and development strategy.

Lavin and Wakman consider some of some of the factors that distinguish media organization from other organizations such as the nature of the product, types of employees, specific institutional variables and the unique role of the media organizations in the society (Rashkiyani, 2006, 50).

However, about related research in the country, research investigation suggested that valuable and useful research has been done that have similarities with the subject. Among these categories, the research of Dr. Majid Tehranian, titled "Media Management" can be stated as scientific researchs in the field of scientific media management has been released in our country. (Rashkiyani, 2006, 51)

He studied on how media manage in policy dividing media into three categories: the private media, the public media and the governmental media and after providing some indicators to achieve media management "stable", "growing" and "influence" refers to the most important problems in media management in Iran and considers these problems over years as:

- 1- Passivity (leaders ignored the demands of the state and people)
- 2- Lack of job dependence (weak in academic and scientific expertise among media managers)
- 3- Illusion of importance (narcissistic professional media managers)
- 4- Rent distribution (among the media managers)
- 5- Drop off (communication management in Iran does not complete media management)
- 6- Low productivity (both in products and in the media products and productivity indicators of human resources working in the media of Iran)

- 7- Weakness of civil society institutions (managers are not relying on the audience and people)

Other research is a research studied by Dr. Ali Asghar Mahaki titled press management in Iran (identifying current and optimal management model in Iran from journalists and media managers' point of view and comparing their perspectives) has been developed as Master thesis at Allameh Tabatabai University in 1998. The results show that there is significant difference between current and desired organizational management in the press.

4. Research method

This study combines quantitative and qualitative methods. First, the local leadership patterns designed using qualitative way and exploratory factor analysis and then using the navigation model of leadership, government and non-government newspapers have been compared with each other.

4.1. Research questions

Main question:

What is appropriate and load leadership model for newspapers in Iran? And how leadership style of government and non-government newspaper differ from each other?

Sub questions:

Are leadership pattern of government and non-government newspapers different in term of charisma?

Are leadership pattern of government and non-government newspapers different in term of learning?

Are leadership pattern of government and non-government newspapers different in term of value-ethnics?

Are leadership pattern of government and non-government newspapers different in term of communication skills?

4.2. Reliability and Validity

Validity means that measurement tool measures desired characteristic not other characteristic and reliability means that if a measured subject be measured by the same tool and under the same conditions again, the results are somewhat similar, accurate and reliable (Poorkazem and Shakeri Navaee, 2004, 53).

4.3. Content validity

The result of Content validity of the measure tool of leadership style using opinions of some media management professors who had teaching experience or experience working in the national press – was confirm of received parameters.

4.4. Structure validity

For a more precise measure of credit of measurement tool, its structure validity was investigated. After that, the results of structure validity using confirmatory

factor analysis separately for each of the learning organization is shown in a Table and the load factor of each index factor, was analyzed.

4.5. Measuring reliability of measurement tool

To measure reliability of measurement tool, consistency reliability of the questionnaire were used. This reliability is a test of the consistency of the respondents answered all questions in a measure or a questionnaire. Since questions are independent

measures of the same concept, they are correlated with each other. The most commonly used test for internal consistency reliability is Cronbach's alpha coefficient that used for questions or multi measure classes. In this study, internal consistency reliability test was done using Cronbach's alpha coefficient which indicates high reliability of measurement tool.

Table 1. Parameter

Row	Parameter	Initial Alpha	Deleted statements	Final Alpha
63	Charisma	0.67	-	0.67
64	Learning	0.02	40 , 44	0.70
65	Value-Ethnics	-0.16	51, 52, 62	0.75
66	Empathy	-0.11	68	0.70

4.6. Statistical population and sample size

Statistical population of this study for designing a leadership model is 56 Media Management professors and people who have over five years management experience in the national press that was selected by snowball method.

Also, the statistical population to compare leadership of government and non-government newspapers are all employees who are directly and indirectly associated with the manager of four government newspapers which respectively are:

- Non-government newspaper A: 12 people
- Non-government newspaper B: 9 people
- Government newspaper A: 15 people
- Government newspaper B: 11 people

5. Data analysis

After factor analysis, using varimax rotation, statements were grouped in four factors. The results show that after factor rotation, a total of 4 factors are explained 100% of the variance. The result of factor analysis shows that 36% of variable variance is

explained by the first factor, 28% by the second factor, 19% by the third and 17% by the fourth factor. Totally, these four factors explain 100% of the variance.

Table 2. Explained variance

First Number	Explained variance	Cumulative percent
1	36.022	36.022
2	27.856	63.878
3	18.834	82.712
4	17.288	100.000

In order to reduce the number of statements, minimum coefficient was assumed 8.0 that this increased the number of statements to 68.

5.1. Reliability Analysis

To measure the reliability of made tool, questionnaire was filled by 53 employees of both government and non-government newspapers that six statements were eventually removed. The results are as follows:

Row	Parameter	Initial Alpha	Deleted statements	Final Alpha
63	Charisma	0.67	-	0.67
64	Learning	0.02	40 , 44	0.70
65	Value-Ethnics	-0.16	51, 52, 62	0.75
66	Empathy	-0.11	68	0.70

In the final stage to identify possible differences in the leadership pattern of governmental and non-governmental newspapers, this questionnaire distributed among 47 people who work directly with the manager in four government and non-government newspapers and then collected. The results are presented as follows:

5.3. The study of variables distribution

To check variables distribution as normal or abnormal, we use Kolmogrof- Smirnof test. This test

checks variable distribution and approximated normal distribution and significance or non-significance of differences between variable distribution and normal distribution. If significance degree (Sig) of Kolmogrof- Smirnof test is less than 0.05, it shows that there is significant different between variable distribution and normal distribution. In other words, variable distribution is abnormal. However, if significance degree is more than 0.05, it shows that there is not significant different between variable

distribution and normal distribution and variable distribution is normal.

Scales	Statistics		Test values		Distribution status
	Average	Standard deviation	Kolmogrof- Smirnof value	Significance level	
Charisma	48.7	8.0	1.274	0.078	Normal
Learning	45.7	5.4	1.371	0.047	Abnormal
Value-ethics	55.5	8.1	1.235	0.094	Normal
Empathy	53.6	10.5	1.031	0.238	Normal

The results of Kolmogrof- Smirnof test show that there is significant different between the distribution of three variables charisma, value-ethics and empathy and normal distribution. In other words, it can be said that these three variables are normal distributed. However, the results of Kolmogrof- Smirnof test for learning variable show that there is significant different between the distribution this variable and normal distribution (Significance value is less than 0.05). So, distribution of learning variable is abnormal.

One of the main assumptions of parametric tests to examine relations between variables is variables distributed normally. Therefore, according to the results of Kolmogrof- Smirnof test it can be concluded that to compare leadership pattern in government and non-government newspapers in term of charisma, value-ethics and empathy, parametric T

test for two independent samples and to compare the difference of leadership pattern in two groups of government newspaper in term of learning, nonparametric Uman Whitney test can be used.

There is difference between nominal two-sided T test of independent variables (government and non-government) and dependent variables (Charisma, learning and empathy variables). This test compares average of two groups (government and non-government) in term of dependent variable score and examines significance or non-significance degree of mean difference between the two groups. Uman Whitney test is like T test but since this test is nonparametric, averages convert to rating averages and rating average for two groups is compared.

First question: Are leadership patterns in government and nongovernment newspapers different in term of the charisma?

	newspaper	numbers	average	Standard deviation	T	Significance
Charisma	Government	26	42.7484	4.20736	10.259	0.000
	Non-government	21	56.1343	4.72954		

According to the above table, the average for charisma variable in government newspaper in range from 0 to 100 is 42.7 and in non-government newspaper is 56.1. T value is 10.259 and its corresponding significance is 0.000. These results indicate that by acceptance 1% error and 99% confidence, observed different between averages of

two groups is significant. So, it can be said that average score of leadership pattern in non-government newspaper in term of charisma is significantly more than government newspaper. Second question: Are leadership patterns in government and nongovernment newspapers different in term of the learning?

	newspaper	numbers	average	uman Whitney	Significance
Learning	Government	26	13.50	351.0	0.000
	Non-government	21	37.00		

According to the above table, the average for learning variable in government newspaper is 13.5 and in non-government newspaper is 37. Significance according to uman Whitney test is 0.000. These results indicate that by acceptance 1% error and 99% confidence, observed different between averages of two groups is significant. So, it

can be said that average score of leadership pattern in non-government newspaper in term of learning is significantly more than government newspaper. Third question: Are leadership patterns in government and nongovernment newspapers different in term of the value-ethics?

	newspaper	numbers	average	Standard deviation	T	Significance
Value-ethics	Government	26	62.2032	2.68392	18.329	0.000
	Non-government	21	47.1487	2.93762		

According to the above table, the average for value-ethics variable in government newspaper in range from 0 to 100 is 62.2 and in non-government

newspaper is 47.1. T value is 18.329 and its corresponding significance is 0.000. These results indicate that by acceptance 1% error and 99%

confidence, observed different between averages of two groups is significant. So, it can be said that average score of leadership pattern in government newspaper in term of value-ethics is significantly more than non-government newspaper.

	newspaper	numbers	average	Standard deviation	T	Significance
Empathy	Government	26	62.1368	4.72371	15.051	0.000
	Non-government	21	43.0688	3.74998		

According to the above table, the average for empathy variable in government newspaper in range from 0 to 100 is 62.1 and in non-government newspaper is 43.1. T value is 15.051 and its corresponding significance is 0.000. These results indicate that by acceptance 1% error and 99% confidence, observed different between averages of two groups is significant. So, it can be said that average score of leadership pattern in government newspaper in term of empathy is significantly more than non-government newspaper.

6. Conclusions and recommendations

This study was conducted to achieve two main goals; firstly, to identify a pattern of local leadership for government and non-government newspapers, and secondly, to compare the pattern of leadership between government and non-government newspapers. For this purpose, first, all leadership models have studied and 134 parameters as parameters of local leadership model have received combining them with Islamic leadership model that is appropriate to the circumstances of Islamic republic of Iran. These indicators provided for 56 professors of media management and newspaper managers. After factor analysis, 68 statements were classified in four classes that the charismatic leader with 32 statements, learning factor with 18 statements, values ethnics factor with 12 statements and communications skills (empathy) with 6 statements were obtained. After implementing a questionnaire in pilot environment and calculating Cronbach's alpha, six statements were removed. And finally the charismatic leadership factor with 32 statements, learning factor with 16 statements, values - ethnics factor with 9 statements and communications skills (empathy) with 5 statements were obtained.

In the last phase of the research aimed to identify possible differences in the pattern of governmental and non-governmental leadership, the questionnaire distributed among employees of four papers were collected. The results of the analysis of the data shows that in all four dimensions Charisma, learning, values - ethics and empathy, there is significant differences between the patterns of leadership in government and non-government newspapers.

Fourth question: Are leadership patterns in government and nongovernment newspapers different in term of communication skills (empathy)?

- The average score of leadership pattern in non-government newspaper in term of charisma is significantly more than government newspaper.
- The average score of leadership pattern in non-government newspaper in term of learning is significantly more than government newspaper.
- The average score of leadership pattern in government newspaper in term of value-ethics is significantly more than non- government newspaper.
- The average score of leadership pattern in government newspaper in term of empathy is significantly more than non-government newspaper.

7. Suggestions:

- 1- It is suggested that the obtained leadership pattern implement in all the newspapers in the country that managers aware of point of view of those who work for them. This is important because managers' understanding about leadership patterns often does not match with their employees.
- 2- Something should prepare to increase security of employees of the public sector in term of job and employment conditions. So, they can show their own creativities and abilities more comfortable.
- 3- It is suggested that managers of government newspapers force their employees to increase their knowledge using rewarding or publishing tools because, unlike non-government newspapers, government newspapers employees have not a concern about their job security even newspapers company give more financial such as loans to their employees. Although it has positive result, but causes some employees don't effort to enhance their abilities.
- 4- It is suggested that government newspaper boss should judge fairly about government managers and their performance and do not interfere their partisan interests.

- 5- It is suggested that newspapers managers - both government and non-government - effort more to empower their audience and increase the power of their readers.

References

1. Afjei, Ali Akbar, "Behavioral Sciences and Islamic Management", Management Studies Journal, No. 21 and 22, Spring and Summer 1378, p. 18-3.
2. Iranzadeh, Soleyman, Khalili, Majid, Rah kooy, Karim, "Determining leadership style and its impact on staff motivation in Pumpiran company", Management science journal, No. 2, Fall 1386, p. 54-83.
3. Baher, Hossein, "Introduction to the General Theory of Management", Journal of Management Studies, No. 1, Spring 1370, p. 15 -23.
4. Badiie, Naeem, Media journal, No. 70, summer 1386, p. 5-7.
5. Pour kazemi, Mohammad Hossein, Shakeri Navaei, Gholamreza, "Organizational culture of the University of Tehran's Faculty of Management and its role in Faculty Productivity", Teacher journal, No. 36, 1386, p. 37-62.
6. Haghani, Mahmood, Azizi, Habib, Rasouli nejad, Abdolhossein, "influence of management styles and personality traits of managers on the mental health of government offices and organization employees in Tehran", Beyond Management Journal, No. 13, Summer 1389, p. 163 -187.
7. Khamenei, Seyed Ali, "Islamic revolution leader remarks in a meeting with officials of the Islamic Republic of Iran – 81/08/20, p. 72, Publications of the political conscience of Defense Ministry (Political Affairs), confidence and hope for the future from Islamic revolution leader point of view, Tehran, 1384.
8. Rashkiyani, Mahdi, "planning an desired pattern for management system of national media from media experts point of view", Media Journal, No. 2, Summer 1387, p. 117 -142.
9. Rezaeeian, Ali, "Establishing an organizational perspective model in the shadow of Islamic Republic of Iran perspective", research and science journal of perfect management, Faculty of Management and Accounting, No. 8 and 9, Winter 1383 and Spring 1384, p. 5 -23.
10. Rezaeeian, Ali, "Human and social capital era", research and science journal of management message, Faculty of Management and Accounting, No. 11 and 12, Summer and Autumn 1383, p. 5 -22.
11. Rezaeeian, Ali, "Requirements of crisis management", research and science journal of perfect management, Faculty of Management and Accounting, No. 4 and 5, Winter 1382 and Spring 1383, p. 15 -28.
12. Saatchi, Mahmood, Kamkari, Kambiz, Asgarian, Mhnaz, Psychological tests, Publication of Virayesh, Tehran, 1389.
13. Soltani, Mohammad Ali, "Principles of Islamic management", Journal of Management Studies, No. 1, Spring 1370, p. 24-16.
14. Conger, G. A. Rabindran, Kangoo, Translated by Vahid Kamaliyan Mehrizi, Hamidreza Esmaeeli Givi, "Charismatic Leadership in Organizations", Samt Publication, 1390, p. 370
15. Labaf, Hassan, Delavi, Mohammad Reza, "Local management: Challenges and Solutions", Journal of Management Studies, No. 43 and 44, Fall and Winter 1383, p. 114 -137.
16. Labaf, Hassan, Ranjbar, Rahim, "Effects of participative management on employee effectiveness", Journal of Management Studies, No. 35 and 36, Fall and Winter 1381, p. 33 -49
17. Mortazavi Saeed et al, "Relation between emotional intelligence and leadership styles (transformational - exchangable), Publication of Humanities Teacher, No. 42, Fall 1384, p. 190-167.
18. Moshabaki, Asghar, Doostar, Mohammad, "Explaining model of emotional intelligence impact on organizational commitment of employees according to role of leadership styles", Journal of teacher, No. 55, Fall 1385, p. 211-234.

9/6/2012

The comparison of injuries in boys' amateur epical athletes in three fields: Kyokushin ka, controlling Karate and Aikido

Dr. Ghofrani Mohsen¹, Mousavi Seyyed Hamed²

1. Department of Physical Education and Sport Sciences, University of Sistan and Baluchestan, Zahedan, Iran
2. MA in Sport Pathology and Corrective Exercises

Abstract: The aim of this purpose was to compare of the dangerous agents of injury in the three martial art fields: Karate, Kyokushin ka, Aikido. The present research is the lasting research that has been analyzed injuries in three last months. The samples of research include 90 Aikido players, 73 Kyokushin ka players, 70 Karate players (with mean and standard deviation age 15.9 ± 1.6 year, high 168.9 ± 6.3 cm, weight 58.5 ± 7.1 kg) from Shiraz clubs. The samples were selected availability and purposefully. The questionnaire of Destamp et al. (2006) was used to collect data and X² test was used to analyze data. The results showed injuries in Aikido was (56.3 percent), Kyokushin ka (24.1 percent) and in Karate (19.5 percent). There were sprain injuries in Karate (31.2 percent), strain injuries in Kyokushin ka (29.6 percent) and bruised injuries in Aikido (32.3 percent). The injuries of lower organs were more than other organs in all three fields, in Aikido (68.4 percent), Kyokushin ka (34.9 percent) and Karate (41.3 percent). Also, the partners' technical error in Karate (30.3 percent), Kyokushin ka (23.7 percent) and partners' knockdown in Aikido (29.9 percent) were known as important mechanics of appearing injuries. Generally, few injuries in Karate (70.6 percent), Kyokushin ka (59.2 percent) and Aikido (60.5 percent) have been more than middle, violent, and very violent. The amount of injuries during exercise (80.6 percent) was significantly more than competition (19.4 percent) in all three fields. The measure of injuries of dominant side in Aikido (51.4 percent) and Karate (45.9 percent) were observed significantly further than non-dominant side position. However, there was not the significant difference in Kyokushin ka. Aikido is an encounter sport, nevertheless the control ways of Karate were done under the semi – encounter laws and it causes fewer injuries in this way.

[Ghofrani Mohsen, Mousavi Seyyed Hamed. **The comparison of injuries in boys' amateur epical athletes in three fields: Kyokushin ka, controlling Karate and Aikido.** *Life Sci J* 2012;9(4):1365-1371] (ISSN:1097-8135). <http://www.lifesciencesite.com>. 206

Key words: amateur epical athletes, Aikido, Karate, Kyokushin ka

1. Introduction

The martial arts have originated from China, Korea and Japan including many different fighting techniques without the use of any weapons. The key benefits of these exercises are self-defense, improving physical fitness, flexibility and self-confidence. Today, East Asian martial arts have been widely expanded among the world's young and adolescents. During 10-15 years recently, these martial arts have been increasingly grown so that women apply these exercises for improving their health and defense skills efficiently (2). For example, in small countries like the Netherlands and Belgium, about nine-thousand boys and girls participated in Taekwondo and Karate and twenty-three thousand were included in other fields of martial arts in the Olympic torments and the world championship. The number of children participated in the U.S martial arts matches were about one-million children (18). Also, due to the dramatic movements in martial arts, children are keenly interested in these activities.(2) these exercises can be Karate ,Aikido, Kyokushin ka which have established favorably in the country. In one hand, the incidence of injuries in martial arts is an inevitable process like other crashing sports and athletes of these exercises are mostly susceptible to risky events. In the

other hand, the high number of interested people in these martial arts along with particular rules and techniques have influenced on the number of injuries in this sports but it is not clarified the real differences of these exercises yet. In addition, there have not been carried out any domestic studies in this regard. Researchers in a review study compared the distribution of the injury in the fields of Kyokushin ka , Aikido and Karate in terms of sex, type, mechanism and the areas of injury; the results of this study showed that generally in martial arts. The rate of injury in girls is lower than boys. Based on injury-based areas, the upper limb in Kyokushin ka, head and face in Karate and lower limbs in Aikido confront with the highest rate of injury; in terms of injury, sprain in kyokoshin ka and Aikido and nose-bleeding in Karate have been reported. Kicking in Kyokushin ka, fisting in Karate and doing cycling kicks in Aikido are mechanisms making the related injuries (8). The other research results in terms of 5 martial arts injuries showed that there is a significant difference between difference martial arts and their type and distribution so that the risky agents in Aikido 59%, Taekwondo 51%, Kong-fu 38%, Karate 30% and Tai-chi 14% were reported. In addition, the risky agent of multi-injuries in Aikido is shown three-fold than Karate.

In the field of injury, sprain in Aikido, strain in Taekwondo and Karate, bruise in Kong-fu and Ti-chi have been known as the greatest injuries in this regard. Based on injury areas, it is obvious that the risky injury of hand and neck, hip, upper and lower limbs were higher in Aikido than Karate (25). German researchers also studied the prevalence of the injury in 15017 martial-workers, 18 year old in 5 martial arts fields. Their results indicated that Taekwondo (36%) in compare to Karate (31%) and Judo (7%) had the highest degree of injury. Also, 95% of these injuries were in moderate level (2). Johnson studied the Karate-ka athletes and their injuries in a research and concluded that the head and neck injuries(51.3%), spinal injuries(23.7%), upper limbs injuries(10.5%), lower limbs injuries(7.9%) and other areas 6.6% were taken place in this regard (12). Boss evaluated 1284 martial arts athletes in 642 tournaments with their movies in a research and the results showed that from these 642 tournaments, 182 cases refer to head injuries, 106 cases about muscular skeleton injuries, 91 subjects in the field of respiratory disorders, 83 cases for minor injuries, 173 matches due to the end of tournaments period and 7 matches were stopped for disqualification; he also concluded that the highest force happening on the head during tournaments is the main reason of these head injuries among athletes (5) the researches carried out in the field of martial arts injuries are at least limited and they have been carried out on few sport fields or the only age variable has been considered as the main parameter of injury areas. The prevalence of fighting injuries in one hand and extra expenses and losing injured athletes forever in the other hand representing the necessity of reducing these injuries as possible; thus the sophisticated analysis of these injuries' type and risky factors in terms of health has been considered as the prevention planning of the injuries. Based on this, we have carried out and compared the most risky agents of Karate, Kyokushin ka and Aikido to show the lowest risk for athletes.

2. Material and Methods

The present study is based on a descriptive-comparative and past-view research which has been studied injuries happened 9 months ago. The statistical sample of the study including all Karate-ka and Kyokushin ka-ka which firstly were active as randomly in Shiraz fighter clubs in 1389.' Few clubs were randomly selected, 70 Karate-ka and 73 Kyokushin ka-ka (amateur).

In other hand, because of confined number of participated clubs, all amateur Aikido (90 ones) were taken up randomly in the study. The range of the subject was between: 14-20 year old, 168+6.3cm, 58.5+7.1 kg. A balanced questionnaire form was applied to collect the related data (Destamb and et.al, 2006, questionnaire form)(9) this questionnaire was consisted of two parts: the first part relates to players personal background including age, height, weight, dominant position, activity period, practice hours per each session and the second part refers to the prevalence of injury in both practice and competition hours, injury mechanism, injury type and vulnerable areas to injury and the outbreak of injury in dominant and non-dominant positions. It is remarkably noted that the context authenticity of the questionnaire was submitted by 5 professional sport physicists. In order to reach to internal reliability of the questionnaire of 30 athletes in Shiraz city during two-weeks, the related questionnaire was completed by the use of Cronbach alpha coefficient, 86%. In this research, the intensity of the injuries was based on Desemb standard method (2006); due to the athlete's absence for the related injury. These are categorized into 4 groups:

Low (not to have absence and continue activity), moderate (more than one session and lower than 8 days absence from activity), intense (absence from activity 8-30 days) and very intense injury (absence more than 30 days from activity). The data collecting method was that the researcher is being participated in the exercise location by the written permission of Aikido, Kyokushin ka and Karate federation; then, he gives questions to all the subjects and interview with athletes to complete the answers. It must be noted that, the diagnosis of all injuries was submitted by the related physician during tournaments. In addition, only low injuries were recorded during exercises. In descriptive level, the statistical indices including the mean, criteria deviation, distributions and percents were used and inferential level, the comparison of injury prevalence in each field of Aikido, Karate and Kyokushin ka was assessed by K-test efficiently. It should be noted that, due to few cases lower than 5 and impossibility of inferential statistic; the results were stated as descriptive.' Also, Cronbach alpha coefficient was used to determine the internal authenticity of the questions. The low level of alpha ($p < 5\%$) was considered as significant have used SPSS 17 software and K-test and Excel for plotting diagrams.

Table1. The background and practice degree per session and week.

	Practice per week (session)		Practice per session (hour)		Sport record(year)	
	C.D	Average	C.D	Average	C.D	Average
Karate	1	3.6	0.5	1.8	1.2	2.7
Kyokoshin ka	0.6	3.1	0.3	1.6	1.1	2
Aikido	1.5	3.7	0.2	1.6	2.4	4.1
Total	1.1	3.5	0.3	1.7	2	3.1

The results showed that in general 732 injuries were recorded in three Karate, Kyokushin ka and Aikido. Sport fields; 471 injuries (523.3 injuries in each 100 athletes) in Aikido, 152 injuries (223.5 injuries in each 100 athletes) in Kyokushin ka and 109 injuries (181.65 injuries in each 100 athlete)

were taken place in Karate. The K-test results representing that the degree of happen injuries in Aikido and per 100 people was significantly higher than Karate and Kyokushin ka ($X^2 = 448.46$, $P=0.000$) (table.2)

Table 2. The number of percent and happened injuries proportion

	Karate		Kyokushin ka		Aikido		Total	
	Percent%	Number	Percent%	Number	Percent%	Number	Percent%	Number
Injury number	14.9	109	20.8	152	64.3	471	100	732
Injury ratio per 100 people	19.5	181.65	24.1	223.5	56.3	523.3		

As shown in table3, the results indicated that in Karate, sprain injuries (31.2%), in Kyokushin ka strain (29.6%) and in Aikido (32.3%) bruise were the highest degree of injuries. In sum, sprain (28.7%), bruise (28.7%) and strain (20.5%) injuries were the most common injuries in the present study. ($X^2 = 695.8$, $P=0.000$)

Table3. Type of happened injuries

	Karate		Aikido		Kyokushin ka		Total	
	Percent%	Number	Percent%	Number	Percent%	Number	Percent%	Number
Bruise	30.3	33	32.3	152	16.4	25	28.7	210
Sprain	31.2	34	28	132	28.9	44	28.7	210
Strain	6.4	7	20.8	98	29.6	45	20.5	150
Break/cutting	11.9	13	1.7	8	14.5	22	5.9	43
Nerve disorders	0	0	7.2	34	1.3	2	4.9	36
Fracture	2.8	3	4.9	23	3.9	6	4.4	32
Brain stroke	4.6	5	1.3	6	0	0	1.5	11
Dislocation	2.8	3	0	0	2.6	4	0.9	7
Others	10.1	11	3.8	18	2.6	4	4.5	33
Total	100	109	100	471	100	152	100	732

Table 4 shows the injuries areas in the body. To compare the degree of injury in different areas of the body, other cases were eliminated from the related data. The statistical results indicated that the injuries of lower limbs (41.3%) in Karate, ($X^2=28.5$, $P=0.000$), Kyokushin ka(34.9%), ($X^2=22.7$,

$P=0.000$), Aikido(68.4%), ($X^2=498.6$, $P=0.000$) are higher than head and neck and upper limb injuries.' These results also showed that lower limbs injuries in Aikido are higher than Kyokushin ka and Karate($X^2=355.12$, $P=0.000$).

Table 4. Injured areas of the body

	Karate		Aikido		Kyokushin ka		Total	
	Percent%	Number	Percent%	Number	Percent%	Number	Percent%	Number
Head and neck	26.6	29	5.3	25	20.4	31	12	85
Trunk/bulk	5.5	6	6.2	29	11.2	17	7	52
Upper limbs	25.7	28	20.2	95	32.9	50	24	173
Lower limbs	41.3	45	68.4	322	34.9	53	57	420
Others	0.9	1	0	0	0.7	1	0.3	2
Total	100	109	0	471	100	152	100	722

Table 5. Mechanisms of injury

	Aikido		Kyokushin ka		Karate		Total	
	%	number	%	number	%	number	%	number
Opponent kick	29.9	141	9.9	15	10.1	11	22.8	167
Opponent's tech. Fault	7.2	34	6.6	10	30.3	33	10.5	77
Insufficient warm-up	13	61	6.6	10	2.8	3	10.1	74
Kick into opponent	7.6	36	1.3	2	26.6	29	9.2	67
Lack of physical fitness	10.2	48	5.3	8	4.6	5	8.3	61
Wrong techniques	7.2	34	23.7	36	6.4	7	6.7	49
Hitting on the ground	1.9	9	6.4	7	0.9	1	6.3	46
Getting Feet to feet	4.9	23	5.3	8	7.3	8	5.3	39
Extra pressure	0	0	18.4	28	0.9	1	4	29
Unsuitable surface of the mattress	3.4	16	5.9	9	0.9	1	3.6	26
Previous damage	1.7	8	6.6	10	3.7	4	3	22
Saloon Temp.	3.4	16	0	0	0	0	2.2	16
Extreme tiredness	3	14	0	0	0	0	1.9	14
Others	6.6	31	5.3	8	5.5	6	6.1	45
Total	100	471	100	152	100	109	100	732

In particular, the mechanisms of injuries showed that in general and totally, the opponent kick(22.8%), opponent technical error(10.5%) and the lack of enough warm-up(10.1%) significantly are the highest mechanisms of the injuries ($X^2=377.6, P=0.000$). the technical error of opponent in Karate(30.3), hitting on the ground in Kyokushin ka(23.7%) and opponent kick in Aikido (29.9%) are the highest mechanisms making the related injuries (table5).

Figure 1 shows that there is a significant difference between the prevalence of injury in both exercise and tournament periods.' So, the greatest degree of these injuries relate to practice time (590 injuries); that is, ($X^2=247.1, P=0.000$) in Karate; practice time injuries (83 injuries) is higher than tournament time (26 injuries) ($X^2=29,8, P=0.000$); in Kyokushin ka also the practice time injuries(115 injuries) are significantly higher than tournament times(37 injuries), ($X^2=40,2, P=0.000$), in Aikido also the practice time injuries(392 injuries) significantly are higher than tournament times(79 injuries), ($X^2=208, P=0.000$); the results also showed that the practice time injuries in Aikido are significantly higher than Karate and Kyokushin ka. ($X^2=293.61, P=0.000$).

Figure 11. Sensitivity analysis showing predicted model outputs as the indicated parameters(W0, Temp0, X0) altered from -60% to +60% of its default value. (a) Total materials reduction. (b) Total substrate use. (c) Maximum biomass concentration. (d) Maximum temperature. (e) Air flow accumulative quantity. (f) Moisture content profile.

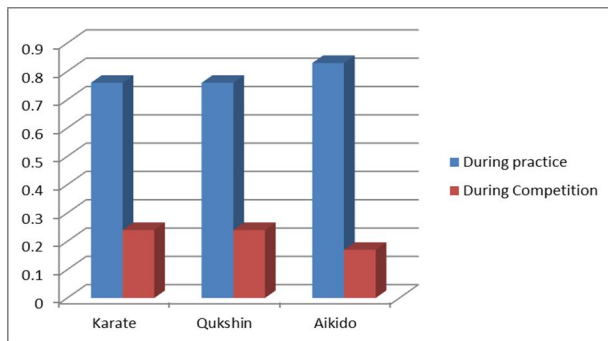

Figure1. The time of injury outbreak

To compare the injury outbreak in dominant and non-dominant positions, the injuries happened in the middle areas of the body were eliminated from the data, and the comparison was carried out based on dominant and non-dominant positions in this regard. The results of K-test showed that the injured degree in dominant area (48.8%) is significantly greater than the lower part ($X^2=16.2, P=0.000$). in

Karate, there is a significant difference between injured degree in dominant position (45.9%) and non-dominant position (21.1%), ($X^2=9.98, P=0.000$). In Aikido and dominant position (51.4%) the injuries are significantly higher than non-dominant part (39.1%), ($X^2=7.89, P=0.005$) while in Kyokushin ka the significant difference between the related areas (42.8% dominant position) and non-dominant part (32.9%) was not found ($X^2=1.95, P=0.162$).

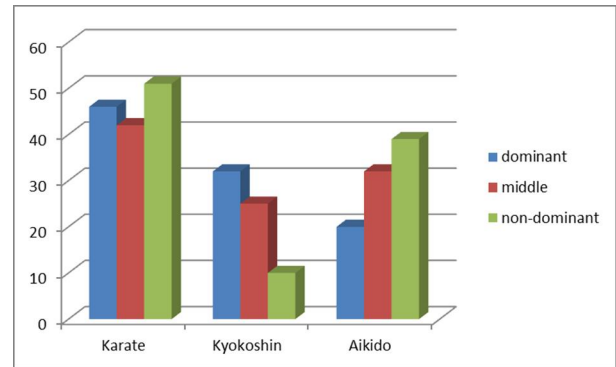

Figure2. Injuries on dominant and non-dominant areas

The information related to the injuries intensity is shown in fig.3. the statistical results representing that the greatest injuries were low(61.7%) which statistically significant ($X^2=347.9, P=0.000$). also, the K-test results showed that these low level injuries in Karate (70.6%), Kyokushin ka (59.2%) and Aikido (60.5%) were greater than moderate, high and very high injuries (fig.3).

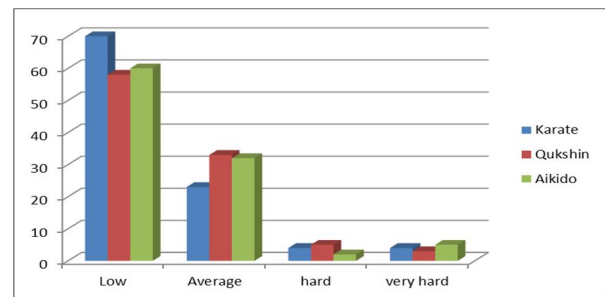

Figure3. Intensity of injuries

3. Results

The obtained results from this study representing that the high degree of injuries prevalence in Aikido and other martial arts is considerably high; Aikido is a complete clashing sport while Karate controlling style is being fulfilled under semi-clash rules, and this makes that sport as the lowest dangerous fighting sport. We recommend Karate controlling style for interested individuals in this regard. Paying attention to some issues like warm-up, techniques recovery,

using protective wearing, confining practice hours and correcting rules can help to decrease any injuries in martial arts.

4. Discussion

The main purpose of the research is to study and compare the prevalence of injury in Aikido, Karate controlling style and Kyokushin ka in amateur male fighters. The results of the present study represented that the injuries happened in Aikido is significantly greater than Kyokushin ka and Karate which are matched to German researcher's results (2). As mentioned before, according to another study, the degree of multi-injuries in Aikido is three-fold than Shotoghan Karate style (25). Smith and et.al (2009) stated that the vulnerability to any damages relates to the activity of athletes. The results of the study representing that injury in sports like Aikido are in high level. In contrast, controlling kicks make the lowest degree of injury (16). Therefore, the degree of injury in Aikido is higher in compare to Karate and Kyokushin ka. In addition to these rules, the degree of injury in each sport field can be effective; the results of Mekan and et.al (2006) showed that the importance of new rules in tournaments is one of the reasons of lowest injuries in prevalence and prevention of these injuries (15). Zetarouk and et.al (2000) also stated that Karate is being done under semi-fighting rules making the lowest injuries in this field (24). The sport background of each athlete can be effective factor in the prevalence of an injury. The results of the study showed that the risky sports like Karate is significantly increasing with athletes sport background (16, 23). In the present study, Aikido-ka athletes had the greatest sport background than Kyokushin ka and Karate-ka athletes which can be one of the reasons of injury prevalence; in this study it is specified that bruise injuries in Aikido, strain in Kyokushin ka and sprain in Karate are the most common injuries from the participants reported. Blocked attacks are the most common prevalence of these injuries. We consider these blockage skills as the most important abilities and using protective tools for preventing any damages is an essential parameter in this regard. The way of achieving joint techniques can be effective in the emergence of these injuries in martial arts. We believe that achieving these joint techniques lead to the high degree of muscular-ligament injuries in martial arts. Moreover, the lack of power and balance in the muscles of the body may cause athletes to muscular-skeleton injuries because the lack of power and correct techniques are related together leading to increase the injuries of tendon and ligaments. In addition to these studies, they have been shown that the incidence of the strain with muscular stretches in the lower limbs of Karate-ka

can happen due to kicking motions without of enough warm-ups (6, 9, 11, 21). It's suggested that practicing with enough warm-up can prohibit any injuries (6, 21). The results of the present study showed that the lower limb is significantly known as the most common injury area in the body and Aikido athletes have faced with lower limbs injuries than Kyokushin ka and Karate athletes. In the recent study, the lower limb in Aikido, upper limbs in Kyokushin ka and head and neck in Karate have been reported as the most well-known areas of injuries. The high usage of feet techniques in Aikido is the high risk factor of injuries. About 80% of these applied techniques in Aikido are kicking by feet. According to this feature of Aikido techniques, it can be studied that due to the high usage of feet, knee to knee kicks and hitting to elbows, the degree of injury in Aikido amateur and professional athletes is happening highly in this regard. Also, in the study it is clarified that the lower limbs is in high-risk area in Kyokushin ka field, will carried out researches , the upper limbs are mostly exposed to the risk areas of injuries in Kyokushin ka (2, 5, 17, 25). The applied techniques and skills in sport fields can influence on the incidence of the injuries in each sport fields. The studies show that, using move-techniques can be essential factor in the incidence of upper limb injuries in Kyokushin ka (17, 25). Of course, the high usage of feet can be a good reason for upper limbs injuries in this study. Completing researches in the field of Kyokushin ka used techniques can be impactful to solve this problem.

In this study, the lower limbs in Karate were in high-risk area which matched to Destamb and et.al (2006) research (9). The lack of using protective tools such as calf-cover and feet-wear during exercise and tournaments by Karate-ka athletes increase the incidence of injuries. Also, kicking without enough warm-up can cause to muscular injuries in Karate. Those, using protective tools for feet and warming-up sufficiently can play key role in prevention of lower limbs injuries in Karate. The results of the study representing that technical faults of opponent in Karate, hitting on the ground in Kyokushin ka and opponent kick in Aikido are considered as the mechanisms of injury in this sport field. We consider the greatest injuries in Karate, ' the opponent technical fault'. The practice of feet and first techniques can reduce the related injuries. Mark and et.al(2011) and Arthur et.al(2006) also believe that the accurate judgments and heavy tools can decrease the degree of injuries in Karate.(16,17) we consider hitting on the ground due to techniques by male athletes as the most essential factor of injuries in Kyokushin ka and wrong application of these techniques can increase the incidence of these

injuries, for Kyokushin ka athletes. The results are matched to other research findings. For getting score in Aikido, the kicks should be down heavily on the opponents. The studies showed that the rapid and heavy feet kicks as un-controlling kicks in Aikido have been down that they can lead to the incidence of injuries of Aikido athletes (7, 22, 23). Anyway, controlling techniques in Karate athletes, correcting Aikido rules and giving precise hitting techniques can be a great background for increasing injuries in Kyokushin ka athletes. Based on the injuries intensity, the greatest degree of injuries relate to low level injuries which is statistically significant Peter(2010) and Halabchi et.al(2007) reported the low level injuries among Karate athletes. The results showed that due to the controlling kicks, the degree of injuries is low and small in Karate (11, 20). According to the results of the present study, we take the lowest risks of injuries among low-experienced and non-professional individuals due to body mass and their low power and ability; we believe that non-professional people are not able to kick heavily like professional ones, so the degree of injury is low. In addition, the results indicated that the greatest degree of injury takes place during practice and tournament times in three Karate, Kyokushin ka and Aikido fields significantly, and the injuries of Aikido is significantly higher than two other ones. The obtained results are matched to the results of Desamb et al. (2006) (9). Researches have called the increase of practice hours per week as a risky factor in the prevalence of sport injuries so that the vulnerability to injury in martial arts with two hours extra practice have been reported in this regard. In a study led by Arthur et.al (2006), they studied that there is a bilateral relationship between the number of session and practice hours with martial arts injuries (17). It is probably the high spending time on practice has been the exact reason for increasing injuries in martial arts. Unfortunately, we have not got the actual time spent by the subjects to explain the regular basis of spending time; therefore, the determination of practice hours and tournaments in martial arts and the study of its relationship with injuries are the topics which can reply to these problem; also, the former researches showed that using protective tools in necessary for fighters during tournaments, but this is not considered at practice hours sufficiently. According to this that only 60% of fighters use protective wearing, it can be concluded that this topic plays a key role in this regard. Due to the lack of enough supervision by coaches, the sample of the study didn't use these protective wearing because of doing easily practices and this makes injuries in high degree during practice hours. According to the present study, to avoid any injuries among fighters

under 18 year old, practicing about three hours per week is reasonable. However, considering accurate practice approaches and using protective wearing can be effective in prevention of any injuries. The results of the present study representing that the percent of dominant position injuries was significantly great in Karate and Aikido but in Kyokushin ka there were no found any significant differences between dominant and non-dominant parts; but it seems that the incidence of injury in dominant part of body is due to an athlete's skills and abilities; even in the present study clarified that injury in the middle part of body than dominant and non-dominant is a little devoted to itself. This can be due to the natural martial arts because most kicks in Aikido and Karate hit to the lateral lobes than middle areas; also the subject studied that the expanded defensive mood through hands and feet come to the middle part of the body during the opponent attack.

References

1. Ariazza R, Leyes M. (2005) Injury profile in competitive Karate: prospective analysis of three consecutive World Karate Championships. *Knee Surg Sports Traumatol Arthrosc*; 13: 603-7.
2. Birrer, R.B. and Halbrook, S.P. (1988) Martial arts injuries: The results of a five-year national survey *American journal of sport medicine* 16, 408-410.
3. Bledsoe GH, Hsu EB, Grabowski JG, Brill JD, Li G. (2006) Incidence of injury in professional mixed martial arts competitions. *J Sports Sci Med. (Combat Sports Special Issue)*: 136 – 142.
4. Buschbacher.R.M, and Shay.T, (1999) Martial arts. *Physical Medicine and Rehabilitation Clinics North America* 10, 35–47.
5. Buse G J, (2006): a 10 year review of mixed martial arts competition, *Br J Sports Med* 2006; 40:169–172. Doi: 10.1136/bjism.
6. Critchley GR, Mannion S, Meredith C. (1999). Injury rates in shotokan Karate. *Br J Sports Med*;33: 174–177.
- 7.6. Corcoran J, Farkus E. (1999). Aikido In: Corcoran J, Farkus E, Sobel S, eds. *The original martial arts encyclopedia: tradition- history-pioneers*. Los Angeles: Pro-Action Publishing:6–11.
8. DeHaven.K and Lintner.D. (1996). Athletic injuries: Comparison by age, sport, and gender, *Am J Sports Med*: 14: 218.
9. Destombe.C, Lejeune.L, Guillodo.Y.(2006). Incidence and nature of Karate injuries. *Joint, Bone, Spine* 73, 182–188.
10. Finch.C, Valuri.G, Ozanne-Smith.J. (1998). Sport and active recreation injuries in Australia:

- evidence from emergency department presentations, *Br J Sports Med*; 32:220–225.
11. Halabchi F, Ziaee V, Lotfian S. (2007). Injury profile in women Shotokan Karate Championships in Iran (2004-2005). *J Sports Sci Med*; 6:52-57.
 12. Johanssen, H.V. and Noerregaard, F.O. (1988). Prevention of injury in Karate. *British journal of sport medicine* 22,113-115.
 13. Kochhar T , Back DL , Mann B , Skinner J . (2005) Risk of cervical injuries in mixed martial arts . *Br J Sports Med*. Jul ; 39 (7) : 444 – 7.
 14. Kongsved, S.M., Basnov, M., Holm-Christensen, K., Hjollund, N.H. (2007) Response rate and completeness of questionnaires: a randomized study of Internet versus paper-and-pencil versions. *J Med Internet Res* 9(3):e25.
 15. Macan, J., Bundalo-Vrbanac, D. and Romić, G. (2006) Effects of the new Karate rules on the incidence and distribution of injuries. *British Journal of Sports Medicine* 40, 326–330.
 16. Mark, M.c., William, Pickett. (2011) Characteristics of martial art injuries in a defined Canadian population: a descriptive epidemiological study. *BMC Public Health*. Volume 10, Number 1, 795, DOI: 10.1186/1471-2458-10-795.
 17. Ortu, M., Vaccarezza, M., Trovati, S., Galli, M. and Gervasoni, C. (2006) A martial arts injury: Karate induced unilateral haematoma of the adrenal gland. *British Journal of Sports Medicine* 40, 730–731.
 18. Pieter W. (2005). Martial arts injuries: Epidemiology of Pediatric Sports Injuries. *Individual Sports. Med Sport Sci*. Basel, Karger, vol 48, pp 59–73.
 19. Pieter W. Caine D, Harmer P, Schiff M. (2009). Epidemiology of Injury in Olympic Sports. *International Olympic Committee Encyclopaedia of Sports Medicine*. Oxford: Wiley-Blackwell. 2009; Pp: 249-59.
 20. Pieter, W. (2010) [Competition injury rates in young Karate athletes](#) Original Research Article *Science & Sports*, Volume 25, Issue 1, Pages 32-38.
 21. Rafael, A., Manuel, L., Hamid, Z., Alvaro, A. (2009) The injury profile of Karate World Championships: new rules, less injuries. *Knee Surg Sports Traumatol Arthrosc* 17:1437–1442 DOI 0.1007/s00167-009-0856-3.
 22. Smith MCSP, P. (2009) Aikido Injuries. *Journal of Sports Therapy* 80: 120-125.
 22. Smith MCSP, P. (2009) Aikido Injuries. *Journal of Sports Therapy* 80: 120-125.
 23. Thomas, D., Herwig, O., Wilfried, H. (2011). Relationship between Asian martial arts and health-related quality of life in Germany. *J Public Health* 19:57–64 DOI 10.1007/s10389-010-0343-9
 24. Zetaruk, M.N., Violan, M.A., Zurakowski, D., Micheli, L.J. (2000). Karate injuries in children and adolescents. *Acc Anal Prev*; 32:421–425.
 25. Zetaruk, M.N, violan MA, Zurakowski, D and michaeli L J. (2005). Injuries in martial arts: a comparison of five styles. *British journal of sport medicine* 39, 29-33.

9/6/2012

Comparison of the Initial State of Active and Passive on the Relative Peak Anaerobic Power and Blood Lactate Elite Handball Players

Gholamhasan jafarzadeh¹, Mohammad Nasiri²

¹Behbahan KhatamAlania University of Technology, Iran

²Department of Physical Education and Sport Science, Khoys branch, Islamic Azad University, Khoys, Iran

Corresponding Author: Gholamhasan.jafarzade@yahoo.com; Mobile:+98 9169714048

Abstract: The purpose of this study and compared to the initial state of active and passive on aerobic power of maximal relativity and elite handball players' blood lactate. Quasi-experimental and experimental research is done. Statistical research, which Behbahan city's elite society Handball players selectively between the desires to cooperate with the plan was formed. The statistical study sample included 20 patients randomly assigned to two groups to be the primary mode of active (AR) and passive (PR) are divided. Three bouts of 2 minutes each Wingate test with 15 minutes played back to the initial state, in inequality; the AR group feet sedentary on ergo meter wheel with 65-55% of maximum heart rate while PR group rested on the wheel. Indices for determining central tendency and dispersion, descriptive statistics and averages for comparing two groups; the t-test for comparison of three tests in a one-way ANOVA was used. The results showed that the group returned to the initial state of the active group compared to the initial conditions were better off in relative peak anaerobic power, which was statistically significant. The data results in both groups showed significant blood lactate.

[Gholamhasan jafarzadeh, Mohammad Nasiri. **Comparison of the Initial State of Active and Passive on the Relative Peak Anaerobic Power and Blood Lactate Elite Handball Players.** *Life Sci J* 2012;9(4):1372-1374] (ISSN:1097-8135). <http://www.lifesciencesite.com>. 207

Key words: Active and passive return to the initial state, Relative peak anaerobic power, Blood lactate

1. Introduction

Fatigue when performing sports activities, one of the major barriers to successful implementation and sports activities. Hence, numerous studies in order to understand the different factors act; schemes to postpone fatigue have done. However, according to the type of exercise, one or several of these factors have a significant role in fatigue.

For example, in endurance activities, evictions and glycogen storage are the most helpless and speed up the rate of oxygen supply is not consistent with glycogen analyze. As a result there is oxygen fraction, the accumulation of lactic acid causes fatigue and frustrate therefore, lactic acid response to heavy and fast sports activities is evident.

Lactate disposal, delay fatigue and improve performance of the factors that affect their return to the initial state can be effective. Findings of early return to active and passive mode during periods of intense exercise repeated with different intervals on anaerobic power, heart rate and blood lactate has been investigated (Draper, 2006).

In research, energy efficiency over the two periods with a maximal speed within 30 seconds of riding time, 4 minutes back to the initial state of active (AR) and passive (PR) was studied, the higher power outputs achieved during the second AR come, but no difference between blood lactate (Bugbanes, 1996). In another study, a significant increase in mean maximal aerobic power

during a time of intense activity within 3 min with a return to the initial state was reported, while no significant difference in lactate (Mavrommatakis, 2006). Evaluation of lactate during exercise and Judo Brazilian national team during 5 minutes (4 place manually Wingate test) with a return within 15 minutes when the initial state, but significant differences were observed in the decrease in lactate (AR) was observed (Francine, 2003).

Gayny and Zafari (2005) results showed that both active and passive recycling program at minutes 5 and 12, the changes in blood lactate caused by an exhaustive exercise, there is no significant difference. Elimination of lactate accumulation in the return to the initial state is close to lactate threshold occurred. And researchers seek to answer is whether the return to the initial state of active and passive on anaerobic power and blood lactate elite Handball players has a different impact?

2. Methodology:

Quasi-experimental and experimental research is done. The population of the city's elite research Handball players PA has formed. The sample was randomly assigned to two groups of 20 patients returned to the initial state of active (AR) and passive (PR) were divided. Three bouts of 2 minutes each Wingate test with 15 minutes played back to the initial state, with the difference that in the AR group during 15 minutes with 65-55% of maximal heart rate

and PR group as they sat down on the wheel Ergo meter the rest. Relative peak anaerobic power, resting blood lactate samples in each instance was measured 3 minutes after each test. Questionnaire developed to measure the physical activity and bicycle ergo meter be a model (Test Ergo meter Wingate) 894E measurement tools were used. Indices for determining central tendency and dispersion, descriptive statistics and averages for comparing two groups, independent t test comparing the average of three tests in a group of one-way ANOVA was used.

3. Results:

Table 1) Comparison of the initial state of activation and inactivation on anaerobic power elite maximal relative Handball players.

Test period	The relative peak anaerobic power (w/kg-1)		
	The first test	The second test	The third test
Back on the initial state	1/2±8/11	35/2±6/11	12/2±3/11
Return to the initial state of the active	15/2±9/10	*6/2±6/13	*25/2±3/15

*p < 0/05

Maximal mean anaerobic power relative to the initial state in the second test ($6/2 \pm 6/13$) and third ($25/2 \pm 3/15$) was significantly higher than the return on the initial state in the second test ($35/2 \pm 6/11$) and the third test ($12/2 \pm 3/11$) has gone up ($p < 0.01$).

Table 2) Comparison of the initial state of active and inactive on the blood lactate elite Handball players.

Test period	Blood lactate (mmol / l -1)		
	The first test	The second test	The third test
Back on the initial state	6/05±2/57	*24/2±02/5	*55/1±80/4
Return to the initial state of the active	66/2±32/6	*4/05±1/27	*3/7±1/27

*p < 0/05

Blood lactate in both groups returned to the initial state in the second test ($27/1 \pm 05/4$) and the third test ($45/1 \pm 7/3$) and the group returned to the initial state on the second test ($24/2 \pm 02/5$) and the third test ($55/1 \pm 80/4$) came down and was statistically significant ($p < 0.01$). However, the reduction in the initial state is back on the second and third test was much lower.

4. Discussion :

In the present study, 15 minutes back to the initial state is maximal and average relative

improvement of the anaerobic Wingate test was the second and third. In the case of sequential anaerobic RA group than in the RP interval more than 15 minutes, significant differences have been reported in previous studies (Francine,2003). While during the interval less than 6 minutes, a significant difference has been reported (Draper,2006).

The second hypothesis, results showed that blood lactate in both groups returned to the initial state off the bottom and was statistically significant. ($p < 0.0$) However, the reduction in the group return to the initial state is to disable the second test was much lower.

Ramazani is aligned with the research findings to mean that blood lactate is less active in the group return to the initial state. In a study on 20 elite swimmers were in the age group 12-14 and 15-20, Changes in blood lactate levels and heart rate returned to normal on two types of swimming (swimming with two intensity) and return on the initial state (sitting) were evaluated.

Results showed that blood lactate levels during the swimmers return to the initial state are active with both the severity of the initial state (sitting) is lower. Reduction in blood lactate between the two age groups of 65-55 percent with only a return to baseline was significant. The relationship between heart rate and blood lactate in the two age groups 20-15 years and 65-55 with a highly significant (Ramezani,2001).

In the present study, reduction in blood lactate levels in the RA group compared to the RP was observed that the main reason it can lactate oxidation by muscles active, inactive, liver and heart lactate turnover is over. In a study of blood lactate values of 2 groups of 5 and 15 minutes of rest and activation was investigated. Wild group of 11 subjects participated in both. Bruce Cunningham for test evaluation and test VO_{2MAX} extreme methods were used to maximal. Group plans to return to the initial state is running on a treadmill with a speed km / h 4, and the rest of the group sitting on the chair and the rest were inactive. Lactic acid and heart rate, subjects were measured on four occasions. Results showed that blood lactate measurements in both groups after 5 and 12 minutes of returning to the initial state there is no significant difference (Gayyny and Zafari, 2005).

5. Conclusion:

Quality can be converted back to the original state during rest and accelerate the disposal of waste generated at the time of intense activity, are crucial. Athlete with the principles of the initial state can return to their abilities to participate in this training to maximize competition. Until lactate levels within the muscle doesn't return to its normal, the

person is fully prepared to participate in the next race. In this study, the researcher has tried to return to the initial state of a place in the competition to be held in tandem with short recovery intervals to measure. Because of the elite wrestlers used to achieve this goal. The results indicate a significant impact on return to the initial state of the maximal anaerobic power and the blood lactate showed significant results in both groups with this difference that results in an active return to the initial state was much better off returning to the initial state. Although the results of research hypotheses were significant, but suggests that the researcher to generalize to other disciplines or functional use it to further research in non-laboratory conditions is required.

Reference:

1. Bugbanes GC. Effects of Active Recovery on Power Output during repeated maximal sprint cycling. *Euro-J-App- Physiologic* 1996; 74 (5) :461-9.
2. Draper N. Effects of active recovery on lactate concentration, heart rate in claiming. *Journal of Sports Science Medicine* 2006; 5:97-105.
3. Francine E. Effects of recovery type after a judo combat on blood lactate removal and on performance in an intermittent anaerobic task. *Journal of Sports Medicine and Physical Fitness* 2003; 43(4): 424-9.
4. Gayny A, Zafari A. Comparing the two programs back to the initial state (off) on blood lactate changes resulting from a strenuous activity exhaustive. *Quarterly Olympics*. In XIII, 2005; No. 32.
5. Mavrommatakis E. Recovery of power output and heart rate kinetics during repeated bouts of rowing exercise with different intervals. *Journal of Sports Science Medicine* 2005; 5:115-122.
6. Menzies P, Menzies C, McIntyre L, Paterson P, Wilson J, Kemi OJ. Blood lactate clearance during active recovery after an intense running bout depends on the intensity of the active recovery. *J Sports Sci*. 2010; 28(9):975-982.
7. Ramezani A, methods of active and passive recovery on blood lactate levels and heart rate after a strenuous activity in elite swimmers, PhD brochure, trends, exercise physiology, Islamic Azad University, Science and Research Branch, Tehran 2001.

9/6/2012

The Role of IMS Functional Architecture in Next Generation Network

Sheyda Kiani Mehr

Shomal University, Amol, Iran

Abstract: The migration to Next Generation Networks is a sea change, a fundamental transformation that is expanded all over the world. It provides converged services over IP. In fact, NGN operates at session layer of OSI model and is aiming to make IP environment deterministic. This is done through establishing end-to-end sessions among communicating parties. From functional architecture perspective NGN is divided into two mainly stratum which are defined separately, but the main focus in this paper is the IP Multimedia subsystem which is in the service stratum of NGN. IMS is the evolution of the core network vision, where both signaling and bearer are carried over the IP layer, contemplated in the early 2000s by the 3rd Generation Project (3GPP) and the 3GPP2 standards bodies. IMS was later extended by TISPAN for fixed services. It enables the attached end devices to support personalized experience involving simultaneous voice, data, and multimedia sessions. In this paper all the important IMS components are described, according to the TISPAN. In addition to the Core IMS functional architecture, some of its near neighbors which are related to IMS are discussed. In conclusion, it is inferred a key feature of IMS is that the IP network is extended all the way to the user equipment, making the core network access agnostic and enabling all-IP communications throughout.

[Sheyda Kiani Mehr. **The Role of IMS Functional Architecture in Next Generation Network.** *Life Sci J* 2012;9(4):1375-1382] (ISSN:1097-8135). <http://www.lifesciencesite.com>. 208

Keywords: NGN, 3GPP, TISPAN, IMS.

1. Introduction

The Next Generation Network (NGN) is intended to support a set of assured (and best-effort) end-to-end services over a network composed of heterogeneous sub-networks, and based on the Internet Protocol (IP). One of the main characteristics of the NGN architecture is the uncoupling of services and underlying transport functions (i.e. network technologies) (ETSI TS 102 855 V1.1.1 2011), allowing services and transport to be offered separately and to evolve independently (ITU-T Rec. Y.2011 2004; ETSI TS 102 855 V1.1.1 2011). Therefore, in the NGN architectures there is a clear separation between the functions for services and for networks, and open interfaces are provided between them. Provisioning of existing and new services can then be independent of the transport network and the access technology. In addition the "external" network services are allowed to use their native protocols as was specified in the NGN architecture and interwork with other networks over standardized interfaces and interworking modules. This facilitates the inclusion of more networks, from cable to 4G, within the NGN infrastructure.

Other characteristics of the NGN defined by TISPAN concern the management of overall services and networks (Network Management) through an Operational Support System (OSS). ITU-T (SG-13), ETSI (TISPAN), IETF and 3GPP have defined NGN networks and services and the work on this subject is continuing. There are differences between the details of NGN definitions (including architectures) of the

standards organizations; for example, ES 282 007 on the Core IMS Functionality of TISPAN is a subset of the 3GPP UMTS Architecture defined in TS 123 002 and is restricted to session control functionalities. In turn the TISPAN session control was adopted by 3GPP.

The core IMS excludes Application Servers (AS) that host Access Functions (AF) and transport/media related functions such as the Multimedia Resource Function Processors (MRFP) and the IMS Media Gateway function (IMS-MGW) that is service or network specific. Nevertheless, there is a specific set of features and generally common understanding and convergence across the core functionality, and much of the work on standards is being pursued under the responsibility of the ETSI TISPAN WG (ETSI TS 102 855 V1.1.1 2011).

In the present paper the TISPAN definitions and terminology for NGN and IMS are more focused.

1. 1. TISPAN NGN Architecture

The NGN functional architecture described in the present document complies with the ITU-T Y.2012 general reference model for next generation networks. It is structured according to a service layer and an IP-based transport layer (ETSI ES 282 001 V3.4.1 2009).

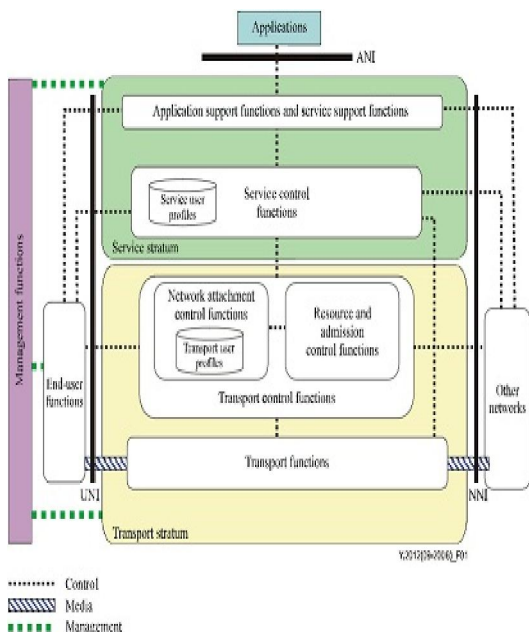

Figure 1. Y.2012 – NGN architecture overview
Separation of services from transport in NGN

The separation of services from transport, allowing them to be offered separately and to evolve independently, is the key cornerstone of NGN (Figure 1) (ITU-T Rec. Y.2011 2004).

In figure 1 the user network interface (UNI), network interface (NNI), and application network interface (ANI) should be understood as general NGN reference points that can be mapped to specific physical interfaces depending on the particular physical implementations (ITU-T Rec. Y.2012 2006).

1.1.1. The Transport Layer

The transport layer comprises a transport control sub-layer on top of transport processing functions in the access and core networks (Figure 2) (ETSI ES 282 001 V3.4.1 2009; ETSI TS 102 855 V1.1.1 2011).

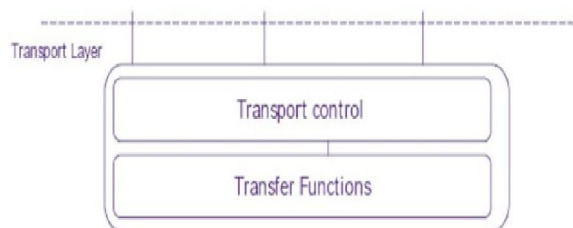

Figure 2: The two sublayers of the Transport Layer

1.1.2. Transport Control

The transport control sublayer consists of two subsystems: the network attachment subsystem (NASS) and the resource and admission control subsystem (RACS) (ETSI ES 282 001 V3.4.1 2009).

1. NASS- The Network Attachment Subsystem (NASS) provides registration at access level and initialization of User Equipment (UE) for accessing to the TISPAN NGN services. The NASS provides network level identification and authentication, manages the IP address space of the Access Network and authenticates access sessions. The NASS also announces the contact point of the TISPAN NGN Service/Applications Subsystems to the UE. Network attachment through NASS is based on implicit or explicit user identity and authentication credentials stored in the NASS (ETSI ES 282 004 V3.4.1 2010).

This subsystem provides the following essential functions:

- Dynamic provisioning of IP addresses and other terminal-configuration parameters
- Authentication at the IP layer prior to or during the address-allocation procedure
- Authorization of network access based on user profiles
- Access network configuration based on user profiles
- Location management at the IP layer

Note: The user profiles mentioned above are related to the access subscription only (ETSI ES 282 001 V3.4.1 2009; ETSI ES 282 004 V3.4.1 2010).

2. RACS— Basically offers to Applications Functions (AF) the following functionality on a one per RACS resource reservation session request basis:

- Admission Control: RACS implements Admission Control to the access and aggregation segment of the network. One can imagine various types of admission control going from a strict admission control where any overbooking is to be prevented, to admission control that allows for a certain degree of over subscription or even a trivial admission control (where the authorization step is considered sufficient to grant access to the service).
- Resource reservation: RACS implements a resource reservation mechanism that permits applications to request bearer resources in the access and aggregation networks.
- Policy Control: RACS uses service based local policies to determine how to support requests from.

Applications for transport resources. Based on available information about resource availability and on other policy rules (e.g. priority of the application) RACS determines if a request can be supported and (if successful) RACS authorizes appropriate transport resources and defines L2/L3 traffic policies that are enforced by the bearer service network elements.

- NAT transversal: RACS controls the transversal of far end (remote) NAT.

- NAT/Gate control: RACS controls near-end NAT at the borders of the NGN core network and at the border between a core network and an access network.

RACS offers services to Application Functions (AF) that may reside in different administrative domains (Final draft ETSI ES 282 003 V1.1.1 2006).

1.1.3. Transport processing functions

Transport processing functions in the access and core networks include basic elementary functions supporting packet forwarding and routing, and more specific group of functions defined as functional entities (Figure 3) (ETSI ES 282 001 V3.4.1 2009).

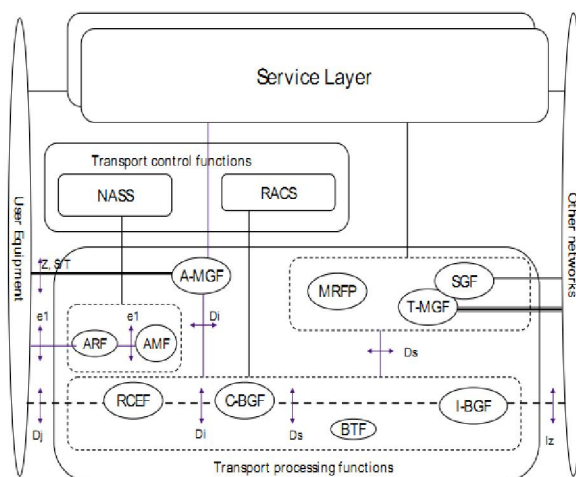

Figure 3. A detailed view of the transfer functions sub-layer

1.2. The Service Layer

The service layer consists of several key subsystems (Figure 4). The NGN needs to support a wide variety of application services. In the Service Stratum therefore, while IMS is at the heart of all emerging NGN standards, it is just one of a number of Service Control Subsystems. In addition to the Service Control Subsystems, the Service Stratum includes a number of common functional entities that can be accessed by more than one subsystem (ETSI TS 102 855 1.1.1 2011). In this document we focus on Core IMS in detail and some of other Subsystem and common components in NGN architecture which are connected to it.

1. Core IMS subsystem— The IP Multimedia Subsystem (IMS) core component of the NGN architecture (Core IMS) supports the provision of SIP-based multimedia services to NGN terminals. It also supports the provision of PSTN/ISDN simulation services.
2. PSTN/ISDN emulation subsystem

3. Other multimedia subsystems (e.g. streaming subsystem, content broadcasting subsystem etc.) and applications.
4. Common components (i.e. used by several subsystems) such as those required for accessing applications, charging functions, user profile management, security management, routing data bases (e.g. ENUM) (ETSI ES 282 007 V1.1.1 2006, ETSI ES 282 001 V3.4.1 2009, Subscription Locator Function, Application Server Function, Interworking Function (ETSI TS 102 855 V1.1.1 2011).

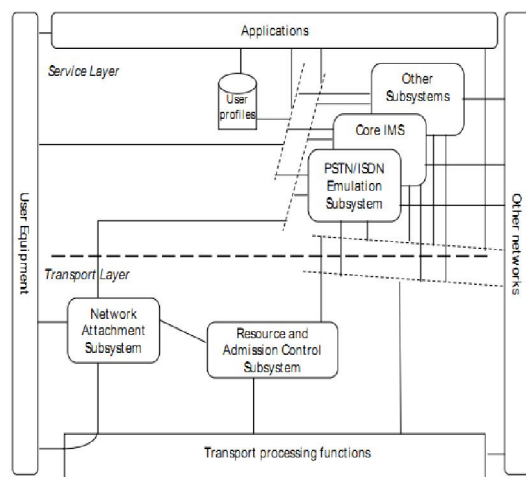

Figure 4. A detailed view of the service layer

2. Introduction to IMS

IMS was initially called IP Multimedia Subsystem — that is, the subsystem that manages multimedia services. This “subsystem” consists of the CN (Core Network) elements necessary for the provision of IP multimedia services (i.e., audio, video, text, chat, image, and a combination of them) delivered over PSNs (Packet-Switched Networks). It was soon realized that, in fact, this is the very center of the network, providing service control for multiple access networks. To reflect that, it is now referred to in standards documentation as the IM (IP Multimedia) CN Subsystem. However, the short reference of IMS remains the popular name for it.

The real value of IMS emerged when it became clear that this subsystem can provide an integrated control layer for many types of access, combining not only Internet services with communications, but also Mobile and Fixed networks. IMS provides service ubiquity for roaming or nomadic users. This brings opportunities for Visited Networks as well as Home Networks. IMS defines the underlying standards, including standards for security, quality-of-service,

and interoperator accounting. (Copeland Rebecca 2008).

2.1. The Evolution of IMS (The TISPAN Approach)

TISPAN is an ETSI group that evolved from the fixed network standards (TIPHON) to define IP standards for NGN (Next Generation Networking) and migration from Fixed Line networks.

TISPAN work drove forward the idea that Mobile and Fixed connections can be converged not only with common transport, but also with common core components (Copeland Rebecca, 2008).

TISPAN works closely with the 3GPP to bring about the fixed mobile convergence to the NGNs, it proposes to use 3GPP IMS for SIP-based applications but adds new components and functional blocks to handle non-SIP applications and other requirements of fixed broadband networks that are not addresses by the 3GPP IMS.

The TISPAN Release 1 architecture which was published in December 2005 is based on the 3GPP IMS Release 6 architecture but is intended to address the wireline provider's requirements.

The architecture uses a 3GPP IMS core where subsystem share common components, while allowing the addition of new components over time in order to cover new demands and service classes. It ensures that the network resources, applications and user equipment that are inherited from IMS are common, thereby ensuring user, terminal and service mobility. Release 1 concentrated on the architecture and functional components and not on the NGN applications. Release 2 is expected to address this gap by defining real-life NGN services such as media streaming and others (Khalid Al-Begain and et al 2009).

The TISPAN early definition of Core IMS, with elements that have been defined already by the 3GPP and endorsed by TISPAN, include some functions that have been added by TISPAN, such as AGCF (Access Gateway Control Function), A-BGF (Access Border Gateway Function), RACF (Resource and Admission Control Function), and others. The TISPAN architecture extends the architecture for tethered connections. It specifies the two principal connection types: (1) analog Fixed phones interfaces and (2) IP terminals with advanced multimedia capabilities. These types of terminals require two types of feature management:

1. Emulation. For analog phone to be connected to the Core IP network, TISPAN developed emulation methods that retain almost all the PSTN features, and subscribers may not even notice that they connect to a new IP network.

2. Simulation. For other terminals with multimedia capabilities, TISPAN defined the simulation method, where the same services can be delivered in a different way, with a different format, and with different user interfaces.

TISPAN developed additional subsystems to complement Core IMS. In particular, the NASS (Network Attachment Sub-System) and the RACS (Resource and Admission Control Subsystem) are instrumental in the multi-access capability of IMS.

TISPAN also has developed further the procedures at the network border, both on the access side and on the network interconnection side. The control of the border point is the role of the IBCF (Interconnection Border Control Function) that instructs the BGF (Border Gateway Function) to enforce security and routing across the border. The I-BGF (Interconnecting BGF) connects to other IP networks. The C-BGF (Core BGF) connects the IP-CAN to the Core network. The A-BGF (Access BGF) is a border gateway at the access side that applies border control between the CPE (Customer Premises Equipment) server and access networks.

Network Address Translation (NAT) has always been an important issue with NGN where the connection is between elements that maintain different addressing plans. Interworking between private and public NAT zones and between IPv4 and IPv6 are facilitated at the border servers as well as security filtering of packet headers and payload. The IWF (Interworking Function) has been added to smooth out incompatibilities between implementations of SIP or translation of IMS signaling to non-IMS communication (e.g., H.323) (Copeland Rebecca, 2008).

2.2. The IMS Architecture

The IMS standards are maturing now with a wide range of functions and network elements. Some areas of functionality lend themselves to merging for all types of access and for "tethered" (Fixed) and "untethered" (Mobile) communications (Copeland, 2008).

The NGN IMS, also known as "Core IMS" is a subset of the 3GPP IMS which is restricted to the session control functionalities. Application Servers (AS) and transport/media related functions such as the Multimedia Resource Function Processor function (MRFP) and the IP Multimedia Gateway Functions (IM-MGW) are to be outside the "core IMS".

Although essentially identical to the 3GPP IMS entities, NGN IMS functional entities might exhibit minor variations in behaviour, due to differences in access networks and user equipment. However, the NGN IMS architecture defined in the present

2.2.1.3. Media Gateway Control Function (MGCF)

The MGCF (Media Gateway Control Function) is the server that enables IMS to communicate to and from PSTN or ISDN by determining the media path and media management requirements (ETSI TS 102 855 V1.1.1 2011; Copeland Rebecca 2008).

The MGCF is responsible for controlling the media channels in an IMS-MGW (IMS Media Gateway) (ETSI TS 123 002 V9.2.0 2010; Copeland Rebecca 2008; ETSI TS 102 261 V1.1.1 2003) and the call state that relates to that media connection. It determines the next hop for the media path, depending on the routing number for the legacy networks (ETSI TS 123 002 V9.2.0 2010; ETSI TS 102 855 V1.1.1 2011; Copeland Rebecca 2008).

It also performs protocol conversion between ISUP TCAP and the IMS call control protocols (ETSI TS 102 855 V1.1.1 2011; ETSI TS 102 261 V1.1.1 2003; Copeland Rebecca 2008; ETSI TS 123 002 V9.2.0 2010; TS 288 007 V9.2.0 2010). The Media Gateway Controller Function (MGCF) provides the ability to control a trunking media gateway function (T-MGF) through a standardized interface (ETSI TS 102 855 V1.1.1 2011; ETSI ES 282 007 V1.1.1 2006).

Such control includes allocation and deallocation of resources of the media gateway, as well as modification of the usage of these resources (ETSI ES 282 007 V1.1.1 2006).

The MGCF communicates with the CSCF (ETSI ES 282 007 V1.1.1 2006; ETSI TS 123 002 V9.2.0 2010; ETSI TS 102 261 V1.1.1 2003) the BGCF and circuit-switched networks. (ETSI ES 282 007 V1.1.1 2006; ETSI TS 123 002 V9.2.0 2010; ETSI ES 282 007 V1.1.1 2006), The MGCF performs protocol conversion between ISUP and SIP (ETSI TS 102 261 V1.1.1 2003; ETSI ES 282 007 V1.1.1 2006; ETSI TS 123 002 V9.2.0 2010). It also supports interworking between SIP and non-call related SS7 signaling (i.e. TCAP-based signaling for supplementary services such as CCBS). In case of incoming calls from legacy networks, the MGCF determines the next hop in IP routing depending on received signaling information (ETSI ES 282 007 V1.1.1 2006; ETSI TS 123 002 V9.2.0 2010).

In case of transit the MGCF may use necessary functionality for routing transit traffic.

2.2.1.4. Multimedia Resource Function Controller (MRFC)

The MRFC (Media Resource Function Controller) is the signaling controller element that interacts between the media processor and the requestors of media services (Copeland Rebecca 2008).

The Multimedia Resource Function Controller (MRFC), in conjunction with an MRFP located in the transport layer (ETSI ES 282 007 V1.1.1 2006; ETSI TS 102 855 V1.1.1 2011), provides a set of resources within the core network for supporting services. The MRFC interprets information coming from an AS via an S-CSCF and control MRFP accordingly (ETSI TS 123 002 V9.2.0 2010; ETSI ES 282 007 V1.1.1 2006; Rebecca Copeland 2008).

The MRFC, in conjunction with the MRFP, provides e.g. multi-way conference bridges, announcement playback, media transcoding etc (ETSI TS 102 855 V1.1.1 2011; ETSI ES 282 007 V1.1.1 2006).

3 The PSTN/ISDN Emulation subsystem (PES)

The PSTN/ISDN Emulation Subsystem supports the emulation of PSTN/ISDN services for legacy terminals connected to the NGN, through residential gateways or access gateways (ETSI ES 282 001 V3.4.11, 2009).

PSTN/ISDN emulation functions as a subsystem within an NGN at the same level as the IMS. Consequently it uses the same general interfaces as the IMS to the Transport, Network Attachment and Resource and Admission Control subsystems and Support Functions. However the semantics are not always the same in every case (Final draft ETSI ES 282 002 V1.1.1, 2006).

4. Application Server Types

Three types of Application Server Functions (ASF) can be accessed by the IMS through the ISC or Ma reference point (figure 6).

- SIP Application Servers (SIP AS);
- The IM-SSF Application Server;
- The OSA SCS Application Server.

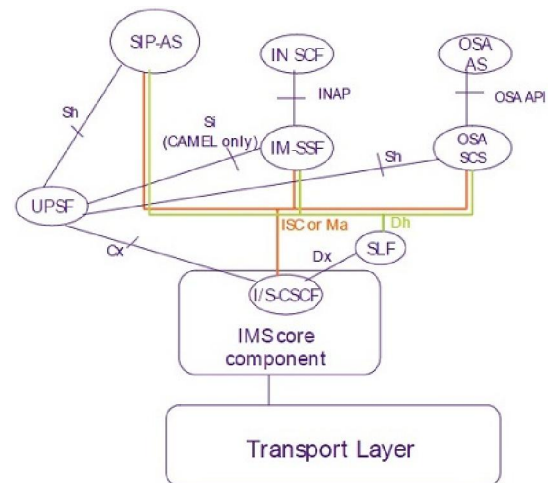

Figure 6. Application Server as a Value Added Services architecture

A SIP Application Server may contain 'Service Capability Interaction Manager' (SCIM) functionality and other application servers. The SCIM functionality is an application which performs the role of interaction management. The internal structure of the application server is outside the standards (ETSI TS 123 002 V9.2.0 2010; ETSI ES 282 007 V1.1.1 2006).

The purpose of the IM SSF is to enable access to IN service logic programs hosted in legacy SCPs. The IM-SSF functionality encompasses the emulation of the IN Call Model (BCSM) on top of SIP signalling, IN triggering and feature management mechanisms, emulation of the IN Service Switching Finite State Machine and interworking with INAP.

The purpose of the OSA Service Capability Server is to provide access to OSA applications. The Service-CSCF to AS interface is used to forward SIP requests, based on filter criteria associated with the originating or destinating user (ETSI ES 282 007 V1.1.1 2006).

The Interrogating-CSCF to AS interface is used to forward SIP requests destined to a Public Service Identity hosted by the AS directly to that AS (ETSI ES 282 007 V1.1.1 2006; ETSI TS 123 002 V9.2.0 2010).

5. User Profile Server Function (UPSF)

The User Profile Server Function (UPSF) is responsible for holding the following user related information:

- Service-level user identification, numbering and addressing information.
- Service-level user security information.
- Service-level user location information.
- Service-level user profile information.

The UPSF may store user profile information related to one or more service control subsystems and applications.

The UPSF does not contain profile information related to IP connectivity subscriptions. Such information is held in the Network Attachment SubSystem (NASS). However, where it makes sense in the context of a particular business model, the UPSF may be co-located with the data base function of the NASS (ETSI ES 282 001 V3.4.11, 2009).

The UPS (User Profile Server) is the equivalent of HSS in the TISpan specifications. The UPS

(or UPSF) contains user profiles and service subscription data similar to the HSS, but excludes the HLR location management (Copeland Rebecca, 2008).

6. Discussions

From a user's perspective, today's networks have come a long way in fulfilling their purpose of enabling people and their machines to communicate at a distance. However, a key critical success factor (among many) is focused telecommunications industry attention on NGN service concepts and how these concepts can be realized in an NGN environment, from the edges to the core of the network.

The target of NGN is to ensure that all elements required for interoperability and network capabilities support applications globally across the NGN while maintaining the concept of separation between transport and services.

With IMS, mobile or nomadic customers can still have access to a wealth of personalized services independent of their mode of access. The increased popularity of this concept has brought about the need for a wireline access network architecture that can take advantage of core IMS concepts.

An IMS-based architecture is one in which all services offered to a particular customer can access the same subscriber database. This enables a service provider to offer customers a consistent set of personalized services, independent of the access media they use.

Fixed IP networks include several access methods, namely xDSL, cable, or Metro Ethernet. Fixed wireless LANs are also in this category, with WLAN WiFi and WiMAX. The future integrated network must support all these access methods.

Core elements definitions are reasonably stable now and able to process session requests from different access networks. Convergence work is continuing in various subsystems interfacing to Core IMS, in particular the charging functions and resource control.

So to outline the answer of this question "Why IMS in NGN?" There are two points to describe:

- IMS generally fulfills the NGN requirements for conversational services
 - Managed, carrier operated telecom network
 - IMS Release 6 becomes applicable to a range of access network types (3G RAN, WLAN)
 - IMS is access technology independence
- Telecom industry benefit
 - Will enable simple and effective inter-working between Cellular and Wire line
 - Growing IMS market, encouraging greater usage
 - Wider choice of IMS suppliers
 - Market stimulation, decreasing costs (thanks to shared development/deployment costs).

References

1. ITU-T Recommendation Y. (2011). General principles and general reference model for Next Generation Networks.
2. ITU-T Recommendation Y. (2012). Functional requirements and architecture of the NGN release 1
3. ETSI ES 282 001. (2009). Telecommunications and Internet converged Services and Protocols for Advanced Networking (TISPAN); NGN Functional Architecture.
4. ETSI TS 102 855 V1.1.1. (2011). Satellite Earth Stations and Systems (SES); Broadband Satellite Multimedia (BSM); Interworking and Integration of BSM in Next Generation Networks (NGNs).
5. Copeland R. (2008). Converging NGN Wireline and Mobile 3G Networks with IMS, Publisher CRC Press.
6. ETSI ES 282 007 V1.1.1, 2006-06, Telecommunications and Internet converged Services and Protocols for Advanced Networking (TISPAN); IP Multimedia Subsystem (IMS); Functional architecture.
7. Khalid Al-Begain, Chitra Balakrishna, Luis Angel Galindo, John Wiley & Sons. (2009). IMS: A Development and Deployment Perspective, Wiley; 1 edition.
8. ETSI TS 123 002. (2010). Digital cellular telecommunications system (Phase 2+); Universal Mobile Telecommunications System (UMTS); LTE; Network architecture (3GPP TS 23.002 version 9.2.0 Release 9).
9. Final draft ETSI ES 282 003 V1.1.1. (2006). Telecommunications and Internet Converged Services and Protocols for Advanced Networking (TISPAN); Resource and Admission Control Sub-system (RACS); Functional Architecture.
10. ETSI ES 282 004 V3.4.1. (2010). Telecommunications and Internet converged Services and Protocols for Advanced Networking (TISPAN); NGN Functional Architecture; Network Attachment Sub-System (NASS).
11. ETSI TS 102 261 V1.1.1. (2003). Open Network Services and Architecture (ONSA); Abstract architecture and reference points definition; Mapping of functional architectures and requirements for NGN.
12. Final draft ETSI ES 282 002 V1.1.1. (2006). Telecommunications and Internet converged Services and Protocols for Advanced Networking (TISPAN); PSTN/ISDN Emulation Sub-system (PES); Functional architecture..

9/6/2012

Life Science Journal

(Acta Zhengzhou University Overseas Edition)

Call for Papers

The academic journal “*Life Science Journal*” (ISSN: 1097-8135) is inviting you to publish your papers.

Life Science Journal, the Acta Zhengzhou University Oversea Version registered in the United States, is an international journal with the purpose to enhance our natural and scientific knowledge dissemination in the world under the free publication principle. The journal is calling for papers from all who are associated with Zhengzhou University-home and abroad. Any valuable papers or reports that are related to life science-in their broadest sense-are welcome. Other academic articles that are less relevant but are of high quality will also be considered and published. Papers submitted could be reviews, objective descriptions, research reports, opinions/debates, news, letters, and other types of writings. Let's work together to disseminate our research results and our opinions.

Please send your manuscript to editor@sciencepub.net.

Address:

Life Science Journal - Acta Zhengzhou University Overseas Edition

Marsland Press

PO Box 180432, Richmond Hill, New York 11418, USA

Telephone: (347) 321-7172

Emails: editor@sciencepub.net; sciencepub@gmail.com; lifesciencej@gmail.com;

Website: <http://www.sciencepub.net>; <http://www.lifesciencesite.com>

Volume 9, Number 4, (Cumulative No.31) Part 9 December 25, 2012 ISSN:1097-8135

Life Science Journal

Marsland Press

PO Box 180432, Richmond Hill, New York 11418, USA

Website:
<http://www.sciencepub.net>

Emails:
editor@sciencepub.net
sciencepub@gmail.com

Phone: (347) 321-7172

Copyright © 2005-2012 Marsland Press / Zhengzhou University

